

The IP Allocation window for the client opens.

The screenshot shows the ARRIS web interface for IP Allocation. At the top, there are navigation tabs for Device, Broadband, Home Network, Voice, Firewall, and Diagnostics. Below these are sub-tabs for Status, Configure, HPNA, Configure, Wi-Fi, MAC Filtering, Wi-Fi Scan, Subnets & DHCP, IP Allocation, and HPNA. The main content area is titled "IP Allocation" and contains a table with the following data:

IPv4 Address / Name	MAC Address	Status	Allocation	Action
192.168.1.145 / FTJP74-02	70:5a:b6:b0:27:cd	on	DHCP Allocation	Allocate
192.168.1.147 / Brians-iPhone	dc:86:d8:e1:67:83	off	DHCP Allocation	Allocate

Below the table is the "IP Allocation Entry" form. It has fields for IPv4 Address / Name (192.168.1.145/FTJP74-02), MAC Address (70:5a:b6:b0:27:cd), and Current Allocation (DHCP Allocation). The New Allocation dropdown menu is open, showing a list of options: Private fixed: 192.168.1.204, Private fixed: 192.168.1.205, Private fixed: 192.168.1.206, Private fixed: 192.168.1.207 (highlighted), Private fixed: 192.168.1.208, Private fixed: 192.168.1.209, Private fixed: 192.168.1.210, and Private fixed: 192.168.1.211. There are Save and Cancel buttons at the bottom of the form.

On the right side, there is a "Help" section with the following text:

**Help**

The IP Allocation table lists DHCP clients and IP Allocated clients. You may want to create an IP Allocated client so that it will always get the same IP address. The IP Allocated clients are still configured as DHCP clients at the client end, but will always be served the same IP address by the device DHCP server.

To create an IP Allocated client select the Allocate button next to the client. The IP Allocation Entry section appears. Choose a Fixed address for the client and click "Save".

To change an IP Allocated client back to a normal DHCP client select it and click "Allocate". Then in the IP Allocation Entry section select "Address from DHCP pool" and click "Save".

Sometimes the lease and the LAN Host Discovery table will not change immediately. You may have to renew the lease or request service at the client for the change to complete.

3. Scroll through the **New Allocation** values and select the address or method to use for the client's DHCP assignment:
  - Click **Address from DHCP Pool** to set the client to accept any valid DHCP address available (standard operation).
  - Click any of the private fixed IP addresses (192.168.1.64 to 192.168.1.253) shown in the list to allocate that IP address to the selected client.
4. Click the **Save** button to save the IP allocation settings. A red "Changes saved" message appears at the top of the IP Allocation page.

Link: HPNA

When you click the [HPNA](#) link, the HPNA Network page appears.

The screenshot displays the HPNA Network page with the following sections:

- Navigation:** at&t logo, ARRIS logo, and a menu bar with tabs: Device, Broadband, Home Network, Voice, Firewall, Diagnostics. Sub-tabs include Status, Configure, HPNA Configure, Wi-Fi, MAC Filtering, Wi-Fi Scan, Subnets & DHCP, IP Allocation, and HPNA.
- HPNA Network Summary:**
  - Firmware Version: 1.9.4 D-UCv1-9-4-27111005-ATT.bin
  - Firmware Signature: 088E9A671CCF31620117D443F1536DBC
  - HPNA Physical Link: DOWN
  - Network Mode: SYNCHRONOUS
- Device Table:**

NodeID	MTU	MAC Address
1	14000	74:f6:12:c5:6d:f2
- Home Network Performance Management Data:** Includes a 'Run extended Test' button and a 'Data Collection Time' table with columns: Station-to-Station performance, PHY Rate, SNR, Rx Power Level, Packet Error.
- HomePNA Statistics:** Includes a 'Refresh' button and a table for Station ID 1:

Station ID	1
Local	
HPNA MAC Address	74:f6:12:c5:6d:f2
HPNA Firmware (C-coax, T=TP)	C
HPNA Version	1.9.4 Aug 30 2011
HPNA Master	#
- Performance Statistics Tables:** Two tables showing metrics from Fri Mar 21 20:05:45 2014 to 20:20:45 2014 and from 19:50:45 2014 to 20:05:45 2014. Metrics include Short Tx/Rx Pkt, CRC Errors Rx, Dropped Tx/Rx, Tx/Rx Error %, Frames Tx/Rx, Bytes Tx/Rx, Unicast/Multicast Tx/Rx, and Local/Remote Control Req/Repl.
- Help:** A sidebar section explaining that the page shows statistics of the HPNA subsystem and provides instructions on using the 'Run Extended Test' and 'Refresh' buttons.

The HPNA Network page displays information about the NVG599 gateway's HPNA-connected devices in 15-minute intervals. You can test the performance of each station to station pair by clicking the [Run extended Test](#) button.

The following page appears as a warning about this invasive test.

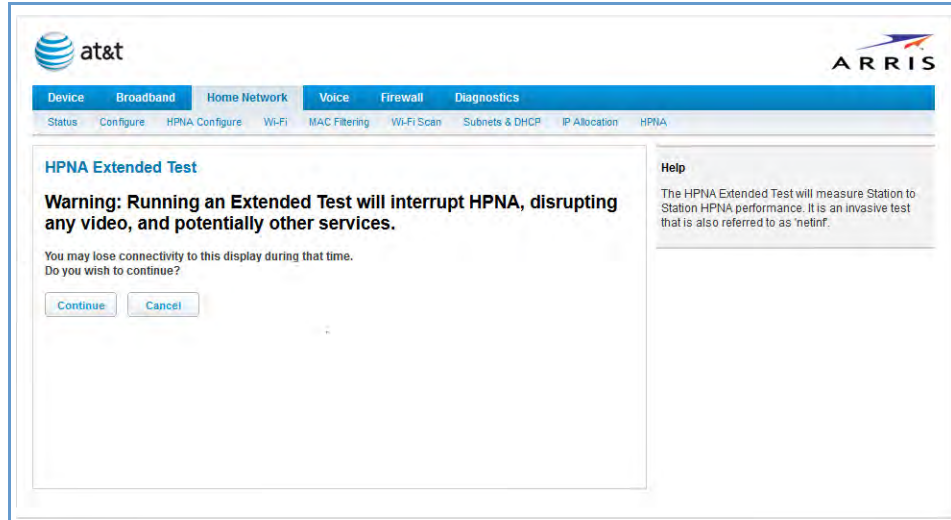

If you do not run the extended test, the station-to-station performance section is not displayed.

You can generate updated statistics by clicking the [Refresh](#) button. HomePNA statistics for the current and previous intervals are displayed below the following static values:

- ◆ Station ID
- ◆ HPNA MAC Address
- ◆ HPNA Firmware (C-coax, T=TP)
- ◆ HPNA Version
- ◆ HPNA Master

Interval statistic fields supply the following information:

Label	Statistic Displayed
Short Tx Pkt	Transmitted Packets
Short Rx Pkt	Received Packets
CRC Errors Rx	Receipt errors
Dropped Tx	Transmit packets dropped
Dropped Rx	Receipt packets dropped
Tx Error %	Percentage of transmitted errors
Rx Error %	Percentage of receipt errors
Frames Tx	Number of frames transmitted
Frames Rx	Number of frames received
Bytes Tx	Bytes transmitted
Bytes Rx	Bytes received
Unicast Tx	Number of unicast packets transmitted
Unicast Rx	Number of unicast packets received
Multicast Tx	Number of multicast packets transmitted
Multicast Rx	Number of multicast packets received
Local Control Req	Number of requests made to the device by local control
Local Control Repl	Number of replies made by the device to local control

Label	Statistic Displayed
Remote Control Req	Number of requests made to the device by remote control
Remote Control Repl	Number of replies made by the device to remote control

## Voice

When you click the **Voice** tab, the Voice Status page appears.

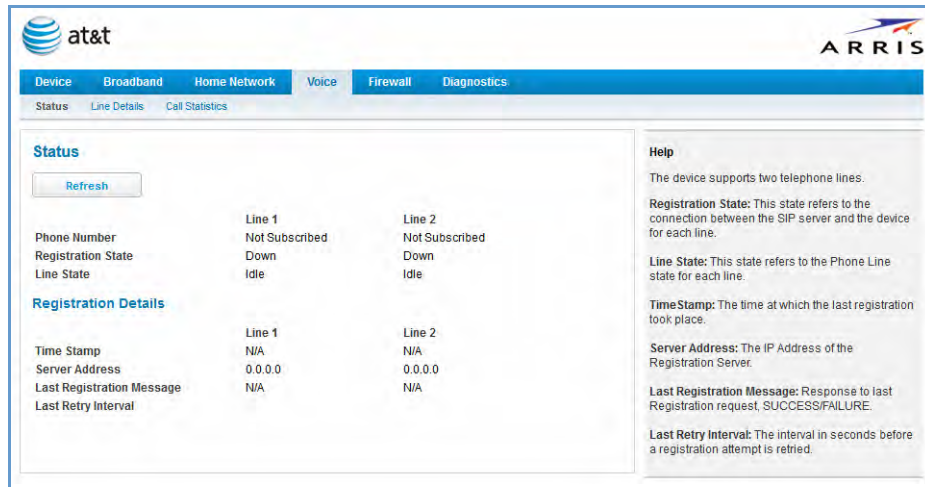

Voice-over-IP (VoIP) refers to voice telephone calls transmitted over the Internet. This type of service differs from traditional phone service that uses the Public Switched Telephone Network (PSTN). VoIP calls use an Internet protocol, Session Initiation Protocol (SIP), to transmit sound over a network or the Internet in the form of data packets.

- ◆ The Voice page displays information about your VoIP phone lines, if configured. Your device supports two phones, **Line 1** and **Line 2**.
- ◆ If either one or both are registered with a SIP server by your service provider or not registered, the Voice page will display their **Registration Details**.

The links at the top of the Voice page provide access to a series of pages that allow you to configure and monitor features of your device.

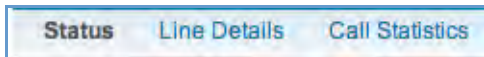

The links bar on the Voice page includes the following links. For more information about each link, see the related section in this guide.

- ◆ **Line Details** (see [page 55](#))
- ◆ **Call Statistics** (see [page 56](#))

---

## Link: Line Details

When you click the [Line Details](#) link, the Line Details page appears.

at&t

ARRIS

Device Broadband Home Network Voice Firewall Diagnostics

Status Line Details Call Statistics

Line Details

Refresh

**Warning: Deregistering a line will disconnect any calls in progress and both incoming and outgoing voice service will be temporarily unavailable.**

	Line 1	Line 2
Phone Number		
Status	Down	Down
Ring	<a href="#">Ring Line 1</a>	<a href="#">Ring Line 2</a>
Register	<a href="#">Register Line 1</a>	<a href="#">Register Line 2</a>

**Help**

This page allows you to display phone numbers being used by phones attached to this device, the status of these phone lines, and ring the phones attached to each line.

Warning: If you deregister the phone line, any calls in progress will be disconnected.

- ◆ If your service provider has enabled your VoIP phone lines, you can register them by clicking the [Register Line 1](#) or [Register Line 2](#) button.
- ◆ To test if the lines are enabled, click the [Ring Line 1](#) or [Ring Line 2](#) button. If enabled and registered, the respective phone will ring for 30 seconds.
- ◆ To clear the current state of each phone line, click the [Reset Line 1](#) or [Reset Line 2](#) button. This will disconnect any calls currently in progress as well.
- ◆ To update the display, click the [Refresh](#) button.

[Link: Call Statistics](#)

When you click [Call Statistics](#), the Call Statistics page appears.

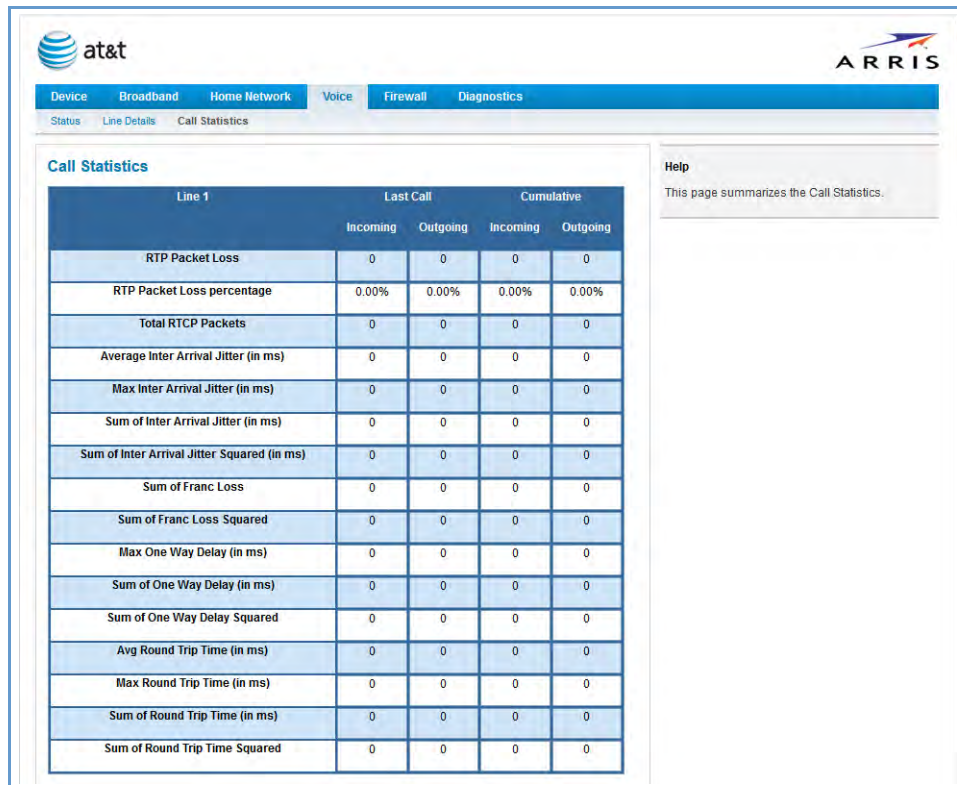

Line 1	Last Call		Cumulative	
	Incoming	Outgoing	Incoming	Outgoing
RTP Packet Loss	0	0	0	0
RTP Packet Loss percentage	0.00%	0.00%	0.00%	0.00%
Total RTCP Packets	0	0	0	0
Average Inter Arrival Jitter (in ms)	0	0	0	0
Max Inter Arrival Jitter (in ms)	0	0	0	0
Sum of Inter Arrival Jitter (in ms)	0	0	0	0
Sum of Inter Arrival Jitter Squared (in ms)	0	0	0	0
Sum of Franc Loss	0	0	0	0
Sum of Franc Loss Squared	0	0	0	0
Max One Way Delay (in ms)	0	0	0	0
Sum of One Way Delay (in ms)	0	0	0	0
Sum of One Way Delay Squared	0	0	0	0
Avg Round Trip Time (in ms)	0	0	0	0
Max Round Trip Time (in ms)	0	0	0	0
Sum of Round Trip Time (in ms)	0	0	0	0
Sum of Round Trip Time Squared	0	0	0	0

For **Line 1** and **Line 2**, the two available phone lines, the Call Statistics page displays the following information:

**Call Statistics - Line 1 and Line 2**

**Last Call/Cumulative – Incoming/Outgoing**

RTP Packet Loss	Real-time Transport Protocol packets dropped
RTP Packet Loss percentage	Percent of Real-time Transport Protocol packets dropped
Total RTCP Packets	Total Real-time Transport Control Protocol packets
Average Inter Arrival Jitter	Calculated continuously in milliseconds as each data packet is received and averaged.
Max Inter Arrival Jitter	The maximum value in milliseconds recorded as each data packet is received.
Sum of Inter Arrival Jitter	Calculated continuously in milliseconds as each data packet is received and totalled.
Sum of Inter Arrival Jitter Squared	Calculated continuously in milliseconds as each data packet is received and the total is squared.
Sum of Franc Loss	Fraction Lost: The fraction of RTP data packets lost since the previous SR or RR packet was sent. This fraction is defined to be the number of packets lost divided by the number of packets expected. This number will be calculated on every RTCP SR packet. Sum of the fraction lost is calculated with all the RTCP packets.
Sum of Franc Loss Squared	Fraction lost is squared with every RTCP SR or RR packet. Sum of all values will give the Sum of Franc Loss Squared.

Max One Way Delay	One-way delay will be calculated in milliseconds on every RTCP SR or RR packet. This value is $(systime - lsr - dslr) / 2$ <i>lsr</i> means last SR timestamp <i>dslr</i> means delay since last SR.
Sum of One Way Delay	The sum of all the one-way delays calculated in milliseconds on every RTCP packet is displayed as Sum of One Way Delay.
Sum of One Way Delay Squared	One-way delay is squared with every RTCP SR or RR packet. Sum of all values will give the Sum of One Way Delay Squared.
Avg Round Trip Time	Average time in milliseconds from this local source to destination address and back again for all logged calls
Max Round Trip Time	Maximum amount of time in milliseconds from this local source to destination address and back again for all logged calls
Sum of Round Trip Time	Sum of time in milliseconds from this local source to destination address and back again for all logged calls
Sum of Round Trip Time Squared	Sum squared of time from this local source to destination address and back again for all logged calls

Call Summary				
	Line 1		Line 2	
	Current Call	Last Completed Call	Current Call	Last Completed Call
Call Timestamp	N/A	0	N/A	0
Type	N/A	N/A	N/A	N/A
Duration (in secs)	N/A	0	N/A	0
Codec in Use	N/A	N/A	N/A	N/A
Far-End Host Information	0.0.0.0	0.0.0.0	0.0.0.0	0.0.0.0
Far-End Caller Information	N/A	N/A	N/A	N/A

Cumulative Since Last Reset		
	Line 1	Line 2
Last Reset Timestamp	N/A	N/A
Number of Calls	0	0
Duration (in secs)	0	0
Number of Incoming Calls Failed	0	0
Number of Outgoing Calls Failed	0	0

For **Line 1** and **Line 2**, the two available phone lines, the Call Summary section displays the following information:

### Call Summary - Line 1 and Line 2

#### Current Call/Last Completed Call

Call Timestamp	Date and time of the current call
Type	May be Incoming or Outgoing
Duration	Length of time in seconds of call connection
Codec in Use	Audio codec used for decoding the call packet traffic.
Far-End Host Information	SIP server IP information: IP address and port number
Far-End Caller Information	Caller ID information, if available

#### Cumulative Since Last Reset



Last Reset Timestamp	Date and time of the last call
Number of Calls	Total number of calls for each VoIP line
Duration	Time in seconds since the last call
Number of Incoming Calls Failed	Number of incoming calls that fail to connect
Number of Outgoing Calls Failed	Number of outgoing calls that fail to connect

The following table shows VoIP line states during various conditions.

VoIP Line 1/2	Hook state	WAN IP	Reg-state	FXS Voltage	Tone	LED
<b>Disabled</b>	On/Off-hook	Up	Idle	Off	N/A	Off
<b>Enabled</b>	On-hook	Up	Registered	On	N/A	Solid
<b>Enabled</b>	Off-hook	Up	Registered	On	Dial tone	Blink
<b>Enabled</b>	On/Off hook	Up	Failure	Off	N/A	Off
<b>Enabled</b>	On/Off hook	Down	Idle	Off	N/A	Off

The following table provides the state changes during the boot-up procedure.

VoIP Line 1/2	WAN Status	Hook State	Reg-state	FXS Voltage	Tone	LED
<b>Disabled</b>	Down	Off-hook	Idle	On-to-off	Off	Off
<b>Enabled</b>	Down	On/Off-hook	Idle	On	Congestion	Off
<b>Enabled</b>	Up	Off-hook	Registered	On	Congestion. Dial Tone played after the hook state is changed.	On



---

## Firewall

When you click the [Firewall](#) tab, the Firewall Status page appears. The Firewall page displays the status of your system firewall elements.

All computer operating systems are vulnerable to attack from outside sources, typically at the operating system or Internet Protocol (IP) layers. Stateful Inspection firewalls intercept and analyze incoming data packets to determine whether they should be admitted to your private LAN, based on multiple criteria, or blocked. Stateful inspection improves security by tracking data packets over a period of time, examining incoming and outgoing packets. Outgoing packets that request specific types of incoming packets are tracked; only those incoming packets constituting a proper response are allowed through the firewall.

Stateful inspection is a security feature that prevents unsolicited inbound access when network address translation (NAT) is disabled. You can configure UDP and TCP “no-activity” periods that will also apply to NAT timeouts if stateful inspection is enabled on the interface. Stateful Inspection parameters are active on a WAN interface only if enabled on your system. Stateful inspection can be enabled on a WAN interface whether NAT is enabled or not.

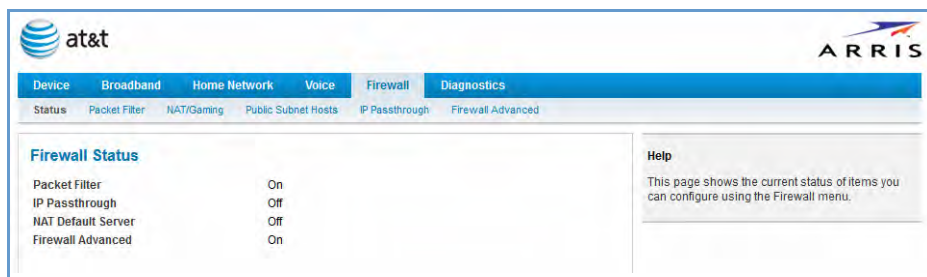

The Firewall Status page shows whether the each firewall feature is On or Off.

The links at the top of the Firewall page provide access to series of pages that allow you to configure security features of your device.

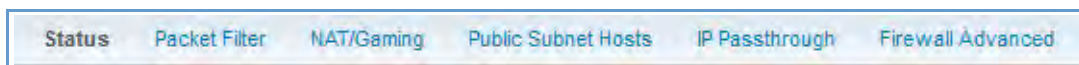

The links bar on the Firewall page includes the following links. For more information about each link, see the related section in this guide.

- ◆ **Packet Filter** (see [page 60](#))
- ◆ **NAT/Gaming** (see [page 67](#))
- ◆ **IP Passthrough** (see [page 72](#))
- ◆ **Firewall Advanced** (see [page 75](#))

[Link: Packet Filter](#)

When you click the [Packet Filter](#) link, the Packet Filter page appears.

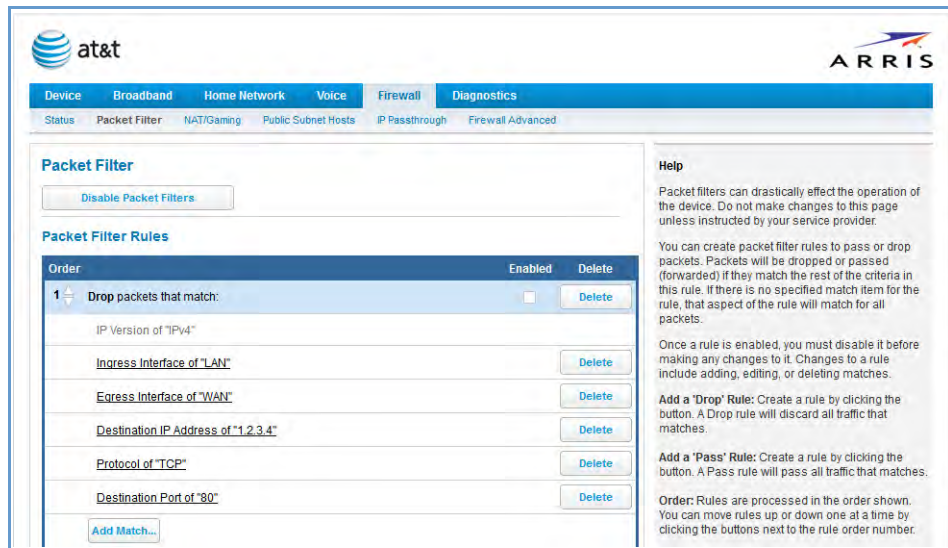

Security should be a high priority for anyone administering a network connected to the Internet. Using packet filters to control network communications can greatly improve your network's security. The Packet Filter engine allows creation of a maximum of eight filtersets. Each filterset can have up to eight rules configured.



**WARNING:**

Before attempting to configure filters and filtersets, please read and understand this entire section thoroughly. The ARRIS NVG599 device incorporating NAT has advanced security features built in. Improperly adding filters and filtersets increases the possibility of loss of communication with the device and the Internet. Never attempt to configure filters unless you are local to the NVG599 device.

Although using filtersets can enhance network security, there are disadvantages:

- Filters are complex. Combining them in filtersets introduces subtle interactions, increasing the likelihood of implementation errors.
- Enabling a large number of filters can have a negative impact on performance. Processing of packets will take longer if they have to go through many checkpoints in addition to NAT.
- Too much reliance on packet filters can cause too little reliance on other security methods. Filtersets are not a substitute for password protection, effective safeguarding of passwords, and general awareness of how your network may be vulnerable.

ARRIS's packet filters are designed to provide security for the Internet connections made to and from your network. You can customize the NVG599 device's filtersets for a variety of packet filtering applications. Typically, you use filters to selectively admit or refuse TCP/IP connections from certain remote networks and specific hosts. You will also use filters to screen particular types of connections. This is commonly called firewalling your network.

Before creating filtersets, you should read the next few sections to learn more about how these powerful security tools work.

---

## Parts of a Filter

A filter consists of criteria based on packet attributes. A typical filter can match a packet on any one of the following attributes:

- ◆ The source IP address (where the packet was sent from)
- ◆ The destination IP address (where the packet is going)
- ◆ The type of higher-layer Internet protocol the packet is carrying, such as TCP or UDP

## Other Filter Attributes

There are three other attributes to each filter:

- ◆ The filter's order (i.e., priority) in the filterset
- ◆ Whether the filter is currently active
- ◆ Whether the filter is set to forward packets or to block (discard) packets

## Design Guidelines

Careful thought must go into designing a new filterset. You should consider the following guidelines:

- ◆ Be sure the filterset's overall purpose is clear from the beginning. A vague purpose can lead to a faulty set, and that can actually make your network less secure.
- ◆ Be sure each individual filter's purpose is clear.
- ◆ Determine how filter priority will affect the set's actions. Test the set (on paper) by determining how the filters would respond to a number of different hypothetical packets.
- ◆ Consider the combined effect of the filters. If every filter in a set fails to match on a particular packet, the packet is:
  - Forwarded if all the filters are configured to discard (not forward)
  - Discarded if all the filters are configured to forward
  - Discarded if the set contains a combination of forward and discard filters

## An Approach to Using Filters

The ultimate goal of network security is to prevent unauthorized access to the network without compromising authorized access. Using filtersets is part of reaching that goal.

Each filterset you design will be based on one of the following approaches:

- ◆ That which is not expressly prohibited is permitted.
- ◆ That which is not expressly permitted is prohibited.

We strongly recommend that you take the latter, and safer, approach to all of your filterset designs.

## Working with Packet Filters

To work with filters:

1. Accessing the Packet Filter page by clicking the Packet Filter link.

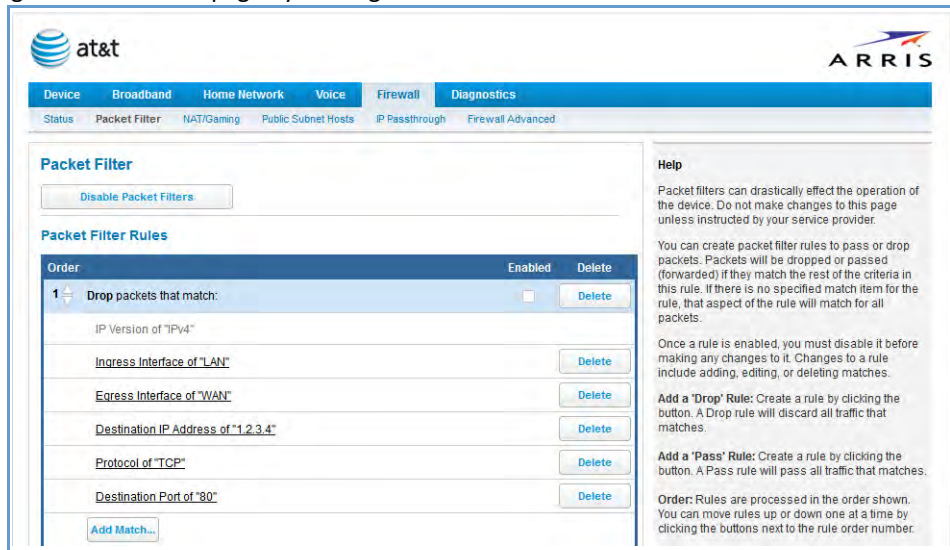

2. Globally turn filters on or off by clicking the [Enable/Disable Packet Filters](#) button.
3. Select the type of packet filter rule by clicking either the [Add a 'Drop' Rule](#) or [Add a 'Pass' Rule](#) button.
  - If you select a drop rule, the specified packets will be blocked.
  - If you select a pass rule, the specified packets will be forwarded.

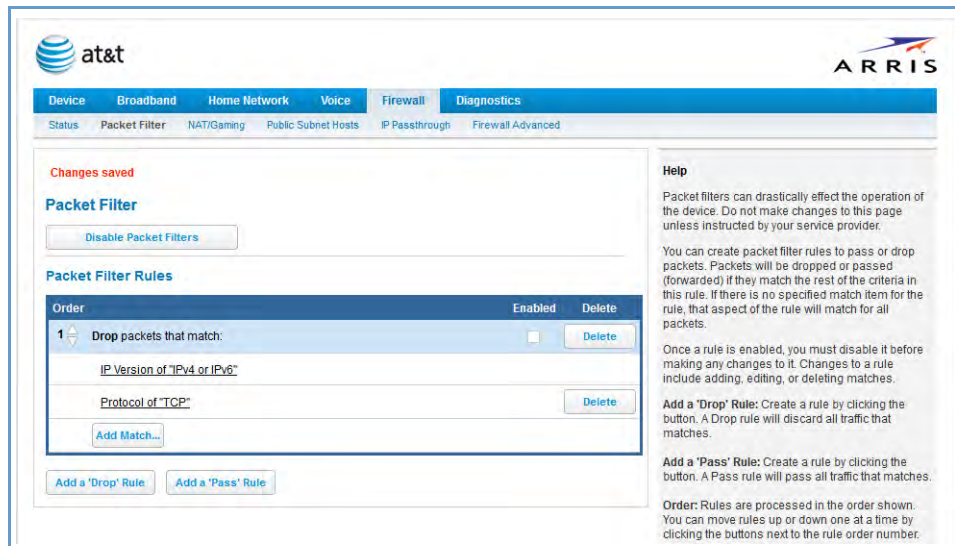

4. Click the **Add Match** button to enter the source IP address or destination IP address this filter will match on. As you create new matches, the list items change. There can only be one match from each match type for a given rule. Match types like **Source Port**, **Destination Port**, and **TCP Flags** are only available if other matches (for example, **Protocol =TCP**) have previously been created.
5. Select a protocol, if necessary, from the pull-down menu: **ICMP**, **TCP**, **UDP**, or **None** to specify any another IP transport protocol.
  - If you chose **by number**, enter the **Protocol by number** here.
  - If you chose **by name**, enter the **Protocol by name** here.
  - Enter the **Source Port** this filter will match on.
  - Enter the **Destination Port** this filter will match on.
  - If you selected **ICMP**, enter the **ICMP Type** here.

**Match Entry**

Match Type:

TCP Flag	Examine	Set
URG	<input type="checkbox"/>	<input type="checkbox"/>
ACK	<input type="checkbox"/>	<input type="checkbox"/>
PSH	<input type="checkbox"/>	<input type="checkbox"/>
RST	<input type="checkbox"/>	<input type="checkbox"/>
SYN	<input type="checkbox"/>	<input type="checkbox"/>
FIN	<input type="checkbox"/>	<input type="checkbox"/>

Match Value:

Enable Rule?

When you are finished configuring the filter, click the **Enter Match** button.

The filter is automatically saved.

### Packet Filter Rules List

Your entries to the packet filter rules list are displayed as a table.

Changes saved

**Packet Filter**

---

**Packet Filter Rules**

Order	Enabled	Delete
1	<input type="checkbox"/>	<input type="button" value="Delete"/>
Drop packets that match:		
Source IP Address of "207.53.17.9"		
<input type="button" value="Delete"/>		
<input style="width: 100%;" type="button" value="Add Match..."/>		
2	<input type="checkbox"/>	<input type="button" value="Delete"/>
Pass packets that match:		
Source IP Address of "207.53.17.0/24"		
<input type="button" value="Delete"/>		
<input style="width: 100%;" type="button" value="Add Match..."/>		



**NOTE:**

**Default Forwarding Filter**

If you create one or more filters that have a matching action of forward, then action on a packet matching none of the filters is to block any traffic.

Therefore, if the behavior you want is to force the routing of a certain type of packet and pass all others through the normal routing mechanism, you must configure one filter to match the first type of packet and apply Force Routing. A subsequent filter is required to match and forward all other packets.

**Management IP traffic**

If the Force Routing filter is applied to source IP addresses, it may inadvertently block communication with the router itself. You can avoid this by preceding the Force Routing filter with a filter that matches the destination IP address of the NVG599 device itself.

**Example:**

Assume a configured Custom Service/Hosted Application for an internal web server whose global port range is 8080-8080. Also assume that we want to allow only one external subnet access to this internal server: 207.53.17.0/24. And finally, assume that we want to disallow one IP address on that subnet, 207.53.17.9, from access to that same server (perhaps they were abusing the system in some way). We would need the following rules:

Input Rules						
Rule Order	Action	Source IP	Destination IP	Protocol	Source Port	Destination Port
1	Drop	207.53.17.9	-	TCP		8080
2	Pass	207.53.17.0/24	-	TCP		8080
3	Drop	-	-	TCP		8080

Changes saved

**Packet Filter**

[Disable Packet Filters](#)

---

**Packet Filter Rules**

Order	Enabled	Delete
1	<b>Drop packets that match:</b>	<a href="#">Delete</a>
	Source IP Address of "207.53.17.9"	<a href="#">Delete</a>
	<a href="#">Add Match...</a>	
2	<b>Pass packets that match:</b>	<a href="#">Delete</a>
	Source IP Address of "207.53.17.0/24"	<a href="#">Delete</a>
	<a href="#">Add Match...</a>	

[Update Order](#)   
 [Add a 'Drop' Rule](#)   
 [Add a 'Pass' Rule](#)



**Caution:**

If the packet filter or port forwarding rule involves TCP port 80 or 3389; or UDP port 47806, 43962, 69, 123, or 53; or if you attempt to add or change a match such that this occurs and you are running in VDSL/Ethernet mode, the following warning will appear.

**Warning**

**Warning: The change you are attempting to make may cause AT&T U-verse TV to stop working properly.**

Please select "Confirm" to continue with the change, or "Cancel" to revert the change.

[Confirm](#)   
 [Cancel](#)

## Example 2

The following example uses the GUI to detail how to create a public subnet.

1. Select **Home Network** -> **Subnets & DHCP** from the Web management GUI.

Device Broadband Home Network Voice Firewall Diagnostics

Status Configure HPNA Configure Wi-Fi MAC Filtering Wi-Fi Scan Subnets & DHCP IP Allocation

### Subnets & DHCP

\* all IP addresses and netmasks must be in IPv4 format nnn.nnn.nnn.nnn

#### Private LAN Subnet

Device IPv4 Address: 192.168.1.254  
Subnet Mask: 255.255.255.0

#### DHCP Server

DHCPv4 Start Address: 192.168.1.64  
DHCPv4 End Address: 192.168.1.253  
DHCP Lease: Days: 1, Hours: 0, Minutes: 0, Seconds: 0  
e.g. 01:00:00:00

#### Public Subnet

Public Subnet Mode: On  
Allow Inbound Traffic: Off  
Public IPv4 Address:   
Public Subnet Mask: 255.255.255.0  
DHCPv4 Start Address:   
DHCPv4 End Address:   
Primary DHCP Pool:  Private  Public

#### Cascaded Router

Cascaded Router Enable: Off  
Cascaded Router Address:   
Network Address:   
Subnet Mask: 255.255.255.248

Save Cancel

2. Select On from the **Public Subnet Enable** drop-down menu.
3. Enter all applicable public subnet IP address information and select Save at the bottom of the view.
4. Select **Firewall** -> **Packet Filter** to create a packet filter that will allow specific traffic to flow to a public LAN client.

Device Broadband Home Network Voice Firewall Diagnostics

Status Packet Filter NAT/Gaming Public Subnet Hosts IP Passthrough Firewall Advanced

Changes saved

### Packet Filter

Disable Packet Filters

#### Packet Filter Rules

Order	Enabled	Delete
1	<input checked="" type="checkbox"/>	Delete
Drop packets that match:		
IP Version of "IPv4"		
Ingress Interface of "LAN"		
Egress Interface of "WAN"		
Destination IP Address of "1.2.3.4"		
Protocol of "TCP"		
Destination Port of "80"		
Add Match...		



5. Scroll to the bottom of the screen and select **Add a Pass Rule**. This rule will allow traffic to flow through the public subnet based on the match criteria that will be set up next.  
The new rule will be at the bottom of the **Packet Rules** list (as shown below).



6. Select the **Add Match** button below the new rule created above. This opens the **Match Entry** view.

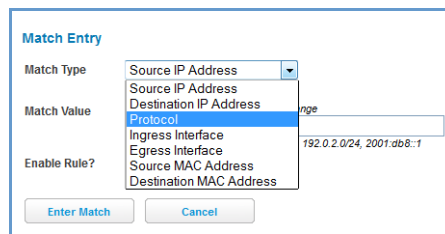

7. For this example, the filter will be made based on a TCP port. Select **Protocol** from the **Match Type** drop-down menu. This automatically fills in **TCP** in the **Match Value** field. At this point do not enable the rule until all criteria have been entered.
8. Click **Enter Match**. This will return the GUI to the **Packet Rules** list.
9. Select **Add Match** below the rule created earlier.
10. Select **Destination Port** from the **Match Type** drop-down menu and enter **21** (this value corresponds to FTP) in the **Match Value** entry box.
11. Click **Enter Match**.
12. Select **Add Match** below the same rule created earlier.

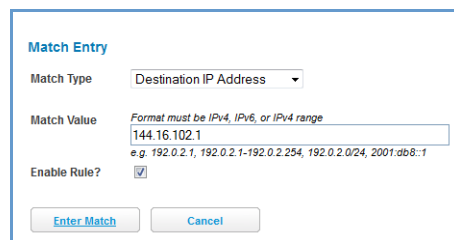

13. Select **Destination IP Address** from the **Match Type** drop-down menu and enter the IP address entered in Step 3 of this procedure.
14. Select the **Enable Rule** check box and click **Enter Match**. The GUI returns to the **Packet Rules** list and the rule is active and grayed out. It cannot be edited without first disabling the rule.

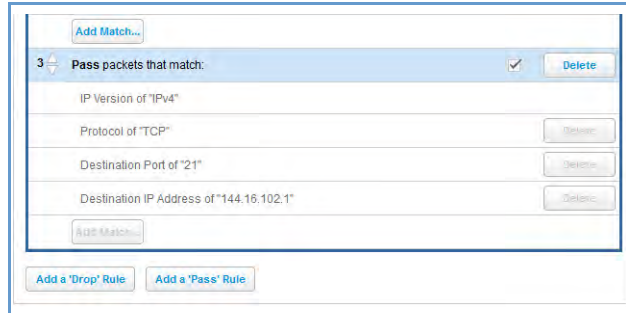

## Link: NAT/Gaming

When you click the [NAT/Gaming](#) link, the NAT/Gaming page appears.

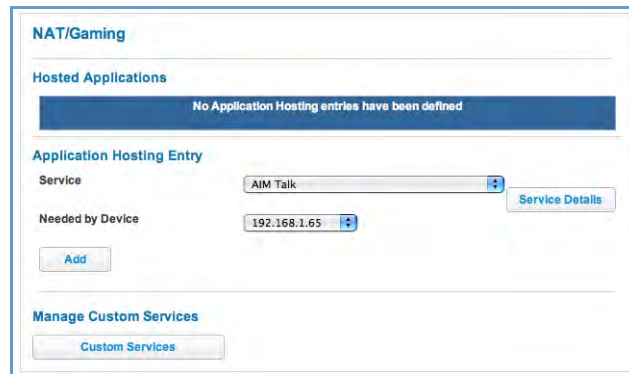

The NAT/Gaming feature allows you to host internet applications when NAT (network address translation) is enabled. You can host different games and software on different PCs.

From the **Service** drop-down menu, you can select any of a large number of predefined games and software. (See [“List of Supported Games and Software” on page 70.](#)) In addition to choosing from these predefined services you can also select a user defined custom service. (See [“Custom Services” on page 68.](#))

For each supported game or service, you can view the protocols and port ranges used by the game or service by clicking the [Service Details](#) button. For example:

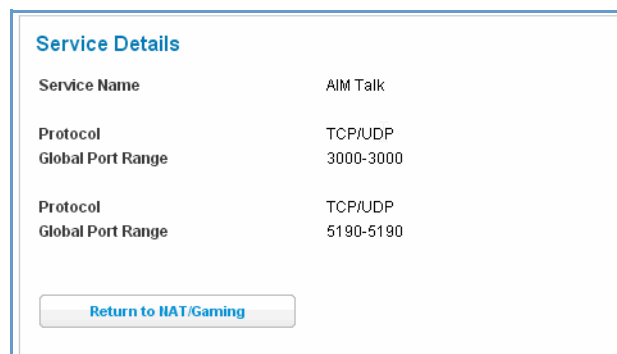

1. Select a hosting device from the **Needed by Device** drop-down menu.

- Once you choose a software service or game, click [Add](#).  
Each time you enable a software service or game, your entry will be added to the list of **Service** names displayed on the NAT/Gaming page.

Changes saved

NAT/Gaming

Hosted Applications

Service	Ports	Device	Delete
AIM Talk	TCP/UDP: 3000,5190	E51311-04	<a href="#">Delete</a>

Application Hosting Entry

Service:  [Service Details](#)

Needed by Device:

[Add](#)

Manage Custom Services

[Custom Services](#)

To remove a game or software from the hosted list, choose the game or software you want to remove and click the [Delete](#) button.

### Custom Services

To configure a custom service, click the [Custom Services](#) button. The Custom Services page appears.

Custom Services

Service List

No Custom Service entries have been defined

Service Entry

Service Name:  e.g. My Gaming Service

Global Port Range:  -  e.g. 2000, 2000-2002

Base Host Port:  e.g. 2000

Protocol:

[Add](#)

[Return to NAT/Gaming](#)

Enter the following information:

- ◆ **Service Name:** A unique identifier for the custom service.
- ◆ **Global Port Range:** Range of ports on which incoming traffic will be received.
- ◆ **Base Host Port:** The port number at the start of the port range your NVG599 device should use when forwarding traffic of the specified type(s) to the internal IP address.
- ◆ **Protocol:** Protocol type of Internet traffic, TCP, UDP, or both.

Click the [Add](#) button.

Each time you add a custom service, your entry will be added to the list of service names displayed on the Custom Services page. In addition, once you define a custom service it becomes available in the **Service** menu on the NAT/Gaming page as one of the services to select.

---

Changes saved

### Custom Services

#### Service List

Name	Global Port Range	Protocol	Host Port	Edit	Delete
MyService	25 - 110	TCP	25	<a href="#">Edit</a>	<a href="#">Delete</a>

#### Service Entry

Service Name   
e.g. My Gaming Service

Global Port Range  -   
e.g. 2000, 2000-2002

Base Host Port   
e.g. 2000

Protocol

[Add](#)

---

[Return to NAT/Gaming](#)

Changes are saved immediately.

To remove this Service, click the [Delete](#) button. To edit this Service, click the [Edit](#) button.



**NOTE:**

You cannot edit a custom service if that service is active; it must be inactive before it can be edited.

---

**List of Supported Games and Software**

AIM Talk	Act of War - Direct Action	Age of Empires II
Age of Empires, v.1.0	Age of Empires: The Rise of Rome, v.1.0	Age of Mythology
Age of Wonders	America's Army	Apache
Asheron's Call	Azureus	Baldur's Gate I and II
Battlefield 1942	Battlefield Communicator	Battlefield Vietnam
BitTornado	BitTorrent	Black and White
Blazing Angels Online	Brothers in Arms - Earned in Blood	Brothers in Arms Online
Buddy Phone	CART Precision Racing, v 1.0	Calista IP Phone
Call of Duty	Citrix Metaframe/ICA Client	Close Combat III: The Russian Front, v 1.0
Close Combat for Windows 1.0	Close Combat: A Bridge Too Far, v 2.0	Combat Flight Sim 2: WWII Pacific Thr, v 1.0
Combat Flight Sim: WWII Europe Series, v 1.0	Counter Strike	DNS Server
Dark Reign	Delta Force (Client and Server)	Delta Force 2
Delta Force Black Hawk Down	Diablo II Server	Dialpad
DirecTV STB 1	DirecTV STB 2	DirecTV STB 3
Doom 3	Dues Ex	Dune 2000
Empire Earth	Empire Earth 2	F-16, Mig 29
F-22, Lightning 3	FTP	Far Cry
Fighter Ace II	GNUtella	Grand Theft Auto 2 Multiplayer
H.323 compliant (Netmeeting, CUSeeME)	HTTP	HTTPS
Half Life	Half Life 2 Steam	Half Life 2 Steam Server
Half Life Steam	Half Life Steam Server	Halo
Hellbender for Windows, v 1.0	Heretic II	Hexen II
Hotline Server	ICQ 2001b	ICQ Old
IMAP Client	IMAP Client v.3	IPSec IKE
Internet Phone	Jedi Knight II: Jedi Outcast	Kali
KazaA	Lime Wire	Links LS 2000
Lord of the Rings Online	MSN Game Zone	MSN Game Zone DX
MSN Messenger	Mech Warrior 3	MechWarrior 4: Vengeance
Medal of Honor Allied Assault	Microsoft Flight Simulator 2000	Microsoft Flight Simulator 98
Microsoft Golf 1998 Edition, v 1.0	Microsoft Golf 1999 Edition	Microsoft Golf 2001 Edition

Midtown Madness, v 1.0	Monster Truck Madness 2, v 2.0	Monster Truck Madness, v 1.0
Motocross Madness 2, v 2.0	Motocross Madness, v 1.0	NNTP
Need for Speed 3, Hot Pursuit	Need for Speed, Porsche	Net2Phone
Operation FlashPoint	Outlaws	POP-3
PPTP	PlayStation Network	Quake 2
Quake 3	Quake 4	Rainbow Six
RealAudio	Return to Castle Wolfenstein	Roger Wilco
Rogue Spear	SMTP	SNMP
SSH server	ShoutCast Server	SlingBox
Soldier of Fortune	StarCraft	StarLancer, v 1.0
Starfleet Command	TFTP	TeamSpeak
Telnet	Tiberian Sun: Command and Conquer	Timbuktu
Total Annihilation	Ultima Online	Unreal Tournament Server
Urban Assault, v 1.0	VNC, Virtual Network Computing	Warlords Battlecry
Warrock	Westwood Online, Command and Conquer	Win2000 Terminal Server
Wolfenstein Enemy Territory	World of Warcraft	X-Lite
XBox 360 Media Center	XBox Live 360	Yahoo Messenger Chat
Yahoo Messenger Phone	ZNES	eDonkey
eMule	eMule Plus	iTunes
mIRC Auth-IdentD	mIRC Chat	mIRC DCC - IRC DCC
pcAnywhere (incoming)		

[Link: IP Passthrough](#)

When you click the [IP Passthrough](#) link, the IP Passthrough page appears.

The screenshot shows the 'IP Passthrough' configuration window. The 'Allocation Mode' dropdown is set to 'Off'. The 'Default Server Internal Address' field is empty, with a placeholder example 'e.g. 192.0.2.1'. The 'Passthrough Mode' dropdown is set to 'DHCPs-dynamic'. The 'Passthrough Fixed MAC Address' field is empty, with a placeholder example 'e.g. 00:01:02:03:04:05'. The 'Passthrough DHCP Lease' is set to 0 days, 0 hours, 10 minutes, and 0 seconds, with a placeholder example 'e.g. 00:00:10:00'. There are 'Save' and 'Cancel' buttons at the bottom.

### IP Passthrough

The IP Passthrough feature allows a single PC on the LAN to have the ARRIS Gateway's public address assigned to it. It also provides PAT (port address translation) (or NATP – network address and port translation) via the same public IP address for all other hosts on the private LAN subnet.

This screenshot is identical to the previous one, but the 'Allocation Mode' dropdown menu is open, showing three options: 'Passthrough', 'Off', and 'Default Server'. The 'Passthrough' option is highlighted in blue.

Using IP Passthrough, the public WAN IP is used to provide IP address translation for private LAN computers. The public WAN IP is assigned and reused on a LAN computer.



DHCP address serving can automatically serve the WAN IP address to a LAN computer.

When DHCP is used for addressing the designated passthrough PC, the acquired or configured WAN address is passed to DHCP, which will dynamically configure a single-servable-address subnet, and reserve the address for the configured PC's MAC address. This dynamic subnet configuration is based on the local and remote WAN address and subnet mask.

- ◆ The two DHCP modes assign the needed WAN IP information to the client automatically.
  - You can select the MAC address of the PC you want to be the IP Passthrough client with **fixed** mode, or,
  - with “first-come-first-served” – **dynamic** – the first client to renew its address will be assigned the WAN IP.
- ◆ **Manual** mode is like statically configuring your PC. With Manual mode, you configure the **TCP/IP Properties** of the LAN client PC you want to be the IP Passthrough client. You then manually enter the WAN IP address, gateway address, and so on that matches the WAN IP address information of your ARRIS device. This mode works the same as the DHCP modes. Unsolicited WAN traffic will get passed to this client. The client is still able to access the ARRIS NVG599 device and other LAN clients on the 192.168.1.x network, etc.
- ◆ The **Passthrough DHCP Lease** – By default, the passthrough host's DHCP leases will be shortened to two minutes. This allows for timely updates of the host's IP address, which will be a private IP address before the WAN connection is established. After the WAN connection is established and has an address, the passthrough host can renew its DHCP address binding to acquire the WAN IP address. You may alter this setting.
- ◆ Click **Save**. Changes take effect upon restart.

## A Restriction

Because both the NVG599 device and the passthrough host will use the same IP address, new sessions that conflict with existing sessions will be rejected by the NVG599. For example, suppose you are a teleworker using an IPSec tunnel from the router and from the passthrough host. Both tunnels go to the same remote endpoint, such as the VPN access concentrator at your employer's office. In this case, the first one to start the IPSec traffic will be allowed; the second one – because, from the WAN, it is indistinguishable – will fail.

The screenshot shows the 'IP Passthrough' configuration window. It includes the following fields and options:

- Allocation Mode:** A dropdown menu with options: Default Server, Off, Default Server, Passthrough.
- Default Server Internal Address:** A dropdown menu labeled 'Choose from list' and a text input field labeled 'Manual Entry' with a placeholder 'e.g. 192.0.2.1'.
- Passthrough Mode:** A dropdown menu with the option: DHCPs-dynamic.
- Passthrough Fixed MAC Address:** A text input field with a placeholder 'e.g. 00:01:02:03:04:05'.
- Passthrough DHCP Lease:** Four spinners for Days, Hours, Minutes, and Seconds. The example shows 0 Days, 0 Hours, 10 Minutes, and 0 Seconds, with a placeholder 'e.g. 00:00:10:00'.

Buttons: Save, Cancel.

### NAT Default Server

The NAT default server feature allows you to:

- ◆ Direct your NVG599 device to forward all externally initiated IP traffic (TCP and UDP protocols only) to a default host on the LAN, specified by your entry in the **Internal Address** field.
- ◆ Enable the default server for certain situations:
  - Where you cannot anticipate what port number or packet protocol an in-bound application might use. For example, some network games select arbitrary port numbers when a connection is opened.
  - When you want all unsolicited traffic to go to a specific LAN host.

This feature allows you to direct unsolicited or non-specific traffic to a designated LAN station. With NAT on in the device, these packets normally would be discarded. For instance, this feature could be used for application traffic where you do not know in advance the port or protocol that will be used. Some game applications fit this profile.

- ◆ Click [Save](#). Changes take effect immediately.

---

## Link: Firewall Advanced

When you click the [Firewall Advanced](#) link the Firewall Advanced screen appears.

**Firewall Advanced**

Drop packets with invalid source or destination IP address

Protect against port scan

Drop packets with unknown ether types

Drop packets with invalid TCP flags

Drop incoming ICMP Echo requests

Suppress ICMP error responses

Flood Limit

Flood rate limit   
e.g. 4

Flood burst limit   
e.g. 8

Flood limit ICMP enable

Flood limit UDP enable

Flood limit TCP enable

Flood limit TCP SYN-cookie

ESP ALG

SIP ALG

All computer operating systems are vulnerable to attack from outside sources, typically at the operating system or Internet Protocol (IP) layers. Stateful inspection firewalls intercept and analyze incoming data packets to determine whether they should be admitted to your private LAN, based on multiple criteria, or blocked. Stateful inspection improves security by tracking data packets over a period of time, examining incoming and outgoing packets. Outgoing packets that request specific types of incoming packets are tracked; only those incoming packets constituting a proper response are allowed through the firewall.

Stateful inspection is a security feature that prevents unsolicited inbound access when NAT is disabled. You can configure UDP and TCP “no-activity” periods that will also apply to NAT timeouts if stateful inspection is enabled on the interface. Stateful Inspection parameters are active on a WAN interface only if enabled on your NVG599 device. Stateful inspection can be enabled on a WAN interface whether NAT is enabled or not.

**DoS Protection** – Denial-of-service (DoS) attacks are common on the Internet, and can render an individual PC or a whole network practically unusable by consuming all its resources. Your NVG599 includes default settings to block the most common types of DoS attacks. For special requirements or circumstances, a variety of additional blocking characteristics are offered. See the following table.

Menu item	Function
Drop packets with invalid source or destination IP address	Whether packets with invalid source or destination IP address(es) are to be dropped
Protect against port scan	Whether to detect and drop port scans.
Drop packets with unknown ether types	Whether packets with unknown ether types are to be dropped
Drop packets with invalid TCP flags	Whether packets with invalid TCP flag settings (NULL, FIN, Xmas, etc.) should be dropped
Drop incoming ICMP Echo requests	Whether all ICMP echo requests are to be dropped; <b>On</b> or <b>Off</b> .
Flood Limit	Whether packet flooding should be detected and offending packets be dropped; <b>On</b> or <b>Off</b> .

<b>Menu item</b>	<b>Function</b>
Flood rate limit	Specifies the number limit of packets per second before dropping the remainder.
Flood burst limit	Specifies the number limit of packets in a single burst before dropping the remainder.
Flood limit ICMP enable	Whether ICMP traffic packet flooding should be detected and offending packets be dropped; <code>On</code> or <code>Off</code> .
Flood limit UDP enable	Whether UDP traffic packet flooding should be detected and offending packets be dropped; <code>On</code> or <code>Off</code> .
Flood limit UDP Pass multicast	Allows exclusion of UDP multicast traffic. <code>On</code> by default.
Flood limit TCP enable	Allows exclusion of TCP traffic. <code>Off</code> by default.
Flood limit TCP SYN-cookie	Allows TCP SYN cookies flooding to be excluded.
Neighbor Discovery Attack protection	Prevents downstream traffic from an upstream device that sends excessive traffic but receives no replies; <code>On</code> or <code>Off</code> .
ESP Header Forwarding	Allows the use of Encapsulating Security Payload (ESP) data payload encryption for IP Secure (IPsec) from qualifying endpoints; <code>On</code> or <code>Off</code> .
Authentication Header Forwarding	Accept and forward IPsec packets with Authentication Headers, which may be used by some IPsec implementations to validate packet sources ; <code>On</code> or <code>Off</code> .
Reflexive ACL	When IPv6 is enabled, Reflexive Access Control Lists can deny inbound IPv6 traffic unless this traffic results from returning outgoing packets (except as configured through firewall rules).

If you make any changes here, click the [Save](#) button.

---

## Diagnostics

When you click the [Diagnostics](#) tab, the Troubleshoot page appears.

The screenshot shows the AT&T/ARRIS router Diagnostics page. The navigation bar includes tabs for Device, Broadband, Home Network, Voice, Firewall, and Diagnostics. The Diagnostics tab is active, showing sub-tabs for Troubleshoot, Logs, Update, Resets, Syslog, Event Notifications, and NAT Table. The main content area is titled "Troubleshoot" and includes a "Run Full Diagnostics" button. A table lists tests for Ethernet, DSL, PTM, IP, and DNS, each with a "Details" button. Below the table is a "Test Internet Access" section with an "Address" input field and buttons for "Ping", "Traceroute", and "NSLookup". A "Progress Window" is located at the bottom. A "Help" section on the right explains the "Multi-layer" diagnostic process and lists result codes: Pass, Fail, and Skipped.

This automated multi-layer test examines the functions of the router from the physical connections to the data traffic being sent by users through the router.

You can run all the tests in order by clicking the [Run Full Diagnostics](#) button.

The device will automatically test a number of components to determine any problems. You can see detailed results of the tests by clicking the [Details](#) buttons for each item. The details presented depend on the configuration of your router and your network type.

Here is an example of the Ethernet Details screen.

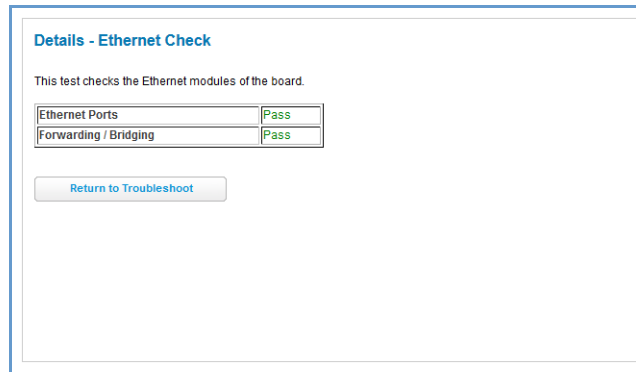

### Test Internet Access

Internet access tests send a ping from the modem to either the LAN or WAN to verify connectivity. A ping could be either an IP address (163.176.4.32) or domain name (www.arris.com). You enter a Web address URL or an IP address in the respective field.

Click the [Ping](#), [Trace](#), or [NSLookup](#) button.

Results will be displayed in the **Progress Window** as they are generated.

- ◆ **Ping** - tests the reachability of a particular network destination by sending an ICMP echo request and waiting for a reply.
- ◆ **Traceroute** - displays the path to a destination by showing the number of hops and the router addresses of these hops.
- ◆ **NSLookup** - converts a domain name to its IP address and vice versa.

To use the ping capability, type a destination address (domain name or IP address) in the text box and click the [Ping](#), [Trace](#), or [Lookup](#) button. The results are displayed in the **Progress Window**.

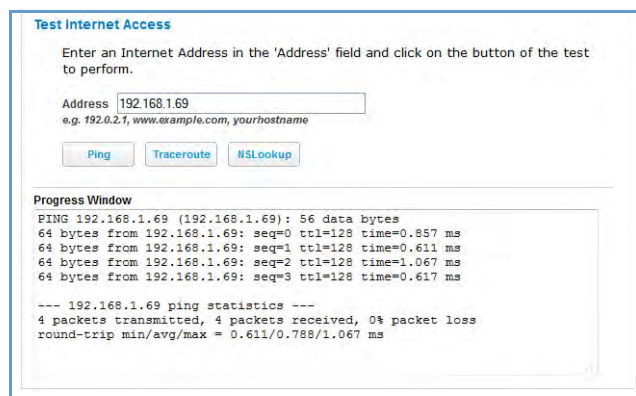

This sequence of tests takes approximately one minute to generate results. Be sure to wait for the test to run to completion.

---

Each test generates one of the following result codes:

Result	Meaning
* PASS:	The test was successful.
* FAIL:	The test was unsuccessful.
* SKIPPED:	The test was skipped because a test on which it depended failed.
* PENDING:	The test timed out without producing a result. Try running the test again.
* WARNING:	The test was unsuccessful. The service provider equipment your modem connects to may not support this test.

Below are some specific tests:

Action	If Ping Fails, Possible Causes Are:
<b>From the Check Connection Page:</b>	
Ping the Internet default gateway IP address	DSL is down, DSL settings are incorrect; gateway's IP address or subnet mask are wrong; gateway router is down.
Ping an Internet site by IP address	Site is down.
Ping an Internet site by name	Servers are down; site is down.
<b>From a LAN PC:</b>	
Ping the modem's LAN IP address	IP address and subnet mask of PC are not on the same scheme as the modem; cabling or other connectivity issue.
Ping an Internet site by IP address	PC's subnet mask may be incorrect, site is down.
Ping an Internet site by name	DNS is not properly configured on the PC, site is down.



[Link: Logs](#)

When you click [Logs](#), the Logs page appears.

The screenshot shows the 'Logs' page with a 'Select Log' dropdown menu open, showing options for 'System', 'Firewall', and 'VoIP'. Below the menu is a list of log entries, each starting with a timestamp and a log level (L6 or L7), followed by a message from 'sdb[318]'. The messages include system boot logs, hardware information, network interface configuration, and ATM subsystem initialization.

The current status of the device is displayed for all logs: **System**, **Firewall**, or **VoIP**. Choose the log you want to display from the drop-down menu.

- ◆ You can clear all log entries by clicking the [Clear Log](#) button.
- ◆ You can save logs to a text (.TXT) file by clicking the [Save to File](#) button. This will download the file to your browser's default download location on your hard drive. The file can be opened with your favorite text editor.



**NOTE:**

Some browsers, such as Internet Explorer for Windows XP, require that you specify the ARRIS device's URL as a "Trusted site" in "Internet Options: Security." This is necessary to allow the download of the log text file to the PC.

The following is an example log portion saved as a .TXT file:

No.	Time	Src IP	Dst IP	Proto	Reason
1	2012-03-06T12:04:56-05:00	10.8.50.176	10.8.205.145	ICMP	ICMP Echo Request
2	P0000-00-00T00:01:34	192.168.1.105	192.168.1.254	TCP	Downstream direction
3	P0000-00-00T00:05:52	192.168.1.105	192.168.1.254	TCP	Downstream direction
4	P0000-00-00T00:08:16	192.168.1.105	192.168.1.254	TCP	Downstream direction
5	2012-03-06T12:22:00-05:00	192.168.1.43	192.168.1.254	TCP	Downstream direction
6	2012-03-06T12:22:20-05:00	10.8.50.176	10.8.205.145	ICMP	ICMP Echo Request
7	2012-03-06T12:24:07-05:00	10.8.50.176	10.8.205.145	ICMP	ICMP Echo Request
8	2012-03-06T12:25:08-05:00	10.8.50.176	10.8.205.145	ICMP	ICMP Echo Request
9	2012-03-06T12:26:09-05:00	10.8.50.176	10.8.205.145	ICMP	ICMP Echo Request
10	2012-03-06T12:28:53-05:00	10.8.50.176	10.8.205.145	ICMP	ICMP Echo Request
11	P0000-00-00T00:00:39	192.168.1.253	255.255.255.255	UDP	Generic Discards
12	2012-03-06T12:33:13-05:00	10.8.50.176	10.8.205.145	ICMP	ICMP Echo Request
13	2012-03-06T12:34:17-05:00	10.8.50.176	10.8.205.145	ICMP	ICMP Echo Request
14	2012-03-06T12:35:20-05:00	10.8.50.176	10.8.205.145	ICMP	ICMP Echo Request
15	2012-03-06T12:36:24-05:00	10.8.50.176	10.8.205.145	ICMP	ICMP Echo Request
16	2012-03-06T12:37:28-05:00	10.8.50.176	10.8.205.145	ICMP	ICMP Echo Request
17	2012-03-06T11:48:18-06:00	10.8.50.176	10.8.205.145	ICMP	ICMP Echo Request
18	2012-03-06T11:49:22-06:00	10.8.50.176	10.8.205.145	ICMP	ICMP Echo Request
19	2012-03-06T11:51:17-06:00	10.8.50.176	10.8.205.145	ICMP	ICMP Echo Request
20	2012-03-06T11:52:21-06:00	10.8.50.176	10.8.205.145	ICMP	ICMP Echo Request
21	2012-03-06T11:56:18-06:00	10.8.50.176	10.8.205.145	ICMP	ICMP Echo Request
22	2012-03-06T11:57:22-06:00	10.8.50.176	10.8.205.145	ICMP	ICMP Echo Request
23	2012-03-06T11:58:26-06:00	10.8.50.176	10.8.205.145	ICMP	ICMP Echo Request
24	2012-03-06T11:59:30-06:00	10.8.50.176	10.8.205.145	ICMP	ICMP Echo Request
25	2012-03-06T12:00:33-06:00	10.8.50.176	10.8.205.145	ICMP	ICMP Echo Request
26	2012-03-06T12:05:11-06:00	10.8.50.176	10.8.205.145	ICMP	ICMP Echo Request
27	2012-03-06T12:06:15-06:00	10.8.50.176	10.8.205.145	ICMP	ICMP Echo Request
28	2012-03-06T12:07:19-06:00	10.8.50.176	10.8.205.145	ICMP	ICMP Echo Request
29	2012-03-06T12:08:23-06:00	10.8.50.176	10.8.205.145	ICMP	ICMP Echo Request
30	2012-03-06T12:09:26-06:00	10.8.50.176	10.8.205.145	ICMP	ICMP Echo Request
31	2012-03-06T10:38:03-08:00	10.8.50.176	10.8.205.145	ICMP	ICMP Echo Request
32	2012-03-06T10:39:06-08:00	10.8.50.176	10.8.205.145	ICMP	ICMP Echo Request
33	2012-03-06T10:40:10-08:00	10.8.50.176	10.8.205.145	ICMP	ICMP Echo Request
34	2012-03-06T10:41:13-08:00	10.8.50.176	10.8.205.145	ICMP	ICMP Echo Request
35	2012-03-06T10:42:17-08:00	10.8.50.176	10.8.205.145	ICMP	ICMP Echo Request
36	2012-03-08T18:28:23Z	10.43.0.156	224.0.0.1	Z	Generic Discards
The last message was repeated 14 times.					
38	2012-03-09T12:48:24Z	10.43.0.156	224.0.0.1	Z	Generic Discards
The last message was repeated 13 times.					
40	2012-03-09T13:24:55Z	10.17.219.52	50.30.8.46	TCP	Downstream direction
41	2012-03-09T13:25:54Z	10.43.0.156	224.0.0.1	Z	Generic Discards
42	2012-03-09T13:30:04Z	10.43.0.156	224.0.0.1	Z	Generic Discards
43	2012-03-09T13:32:09Z	10.43.0.156	224.0.0.1	Z	Generic Discards
44	2012-03-09T13:32:18Z	192.168.1.65	74.125.225.133	TCP	Downstream direction
45	2012-03-09T13:34:14Z	10.43.0.156	224.0.0.1	Z	Generic Discards
46	2012-03-09T13:36:19Z	10.43.0.156	224.0.0.1	Z	Generic Discards
47	2012-03-09T13:38:24Z	10.43.0.156	224.0.0.1	Z	Generic Discards
48	2012-03-09T13:42:34Z	10.43.0.156	224.0.0.1	Z	Generic Discards
49	2012-03-09T13:59:14Z	10.43.0.156	224.0.0.1	Z	Generic Discards
50	2012-03-09T10:09:58-05:00	192.168.1.65	69.171.228.21	TCP	Downstream direction
51	P0000-00-00T00:00:39	192.168.1.43	192.168.1.255	NDP	Generic Discards

### [Link: Update](#)

When you click [Update](#), the Update page appears.

Operating system software is what makes your NVG599 device run, and occasionally it needs to be updated. Your **Current software version** is displayed at the top of the page.



The screenshot shows a web interface titled "Update". It displays the "Current software version: 9.1.4h0d47\_1.7". Below this, there is a paragraph of text explaining that users can manually update the device's software by downloading the latest firmware from the service provider's support site and applying it to their PC's hard drive. It then instructs users to click on "Browse..." to select the update file (\*.bin) and then click on "Update". At the bottom, there is a "Firmware File" label, a "Browse..." button, and the text "No file selected.". Below these are two buttons: "Update" and "Cancel".

To update your software from a file on your PC, you must first download the software from your service provider's support site to your PC's hard drive.

1. [Browse](#) your computer for the operating system file you downloaded and select the file.
2. Click the [Update](#) button.  
The LEDs will operate normally as described in ["Status Indicator Lights" on page 88](#).
3. The installation may take a few minutes and the Web page will indicate a 3-part countdown before returning you to the Home page; wait for it to complete. During the software installation, you will lose Internet and phone service. The LEDs will function as follows:
  - The **Power** LED will flash **Orange/Amber** during firmware upgrade (flash writing to memory) and all other LEDs will be off.
4. The Gateway will restart automatically.  
As the device reboots, the LEDs display power-on behavior.
5. Your new operating system will then be running.

---

## Link: Resets

When you click the [Resets](#) link, the Resets page appears.

In some cases, you may need to clear all the configuration settings and start over again to program the ARRIS NVG599 device. You can perform a factory reset to do this.

It might also be useful to reset your connection to the Internet without deleting all of your configuration settings.

- ◆ Click the [Reset IP](#) button to refresh your Internet WAN IP address. LAN-side users will be briefly disconnected from the Internet, but will otherwise be unaffected.
- ◆ Click the [Reset Connection](#) button to disconnect and reconnect all of your connections, including your VoIP phones.
- ◆ Click the [Reset Device](#) button to reset the Gateway back to its original factory default settings.
- ◆ Click the [Restart](#) button to reboot the device. Previous configuration settings are still retained.

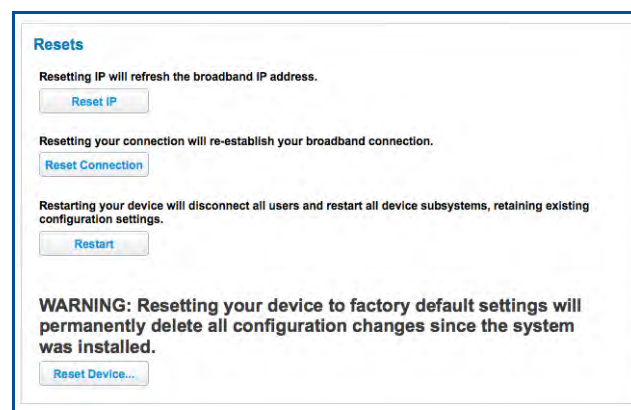

### NOTE:

Exercise caution before performing a factory reset. This will erase any configuration changes that you may have made and allow you to reprogram your NVG599 device.

---

### Link: Syslog

When you click the [Syslog](#) link the Syslog configuration page appears. You can configure a UNIX-compatible (BSD Syslog protocol - RFC 3164) Syslog client to report a number of subsets of the events entered in the device logs.

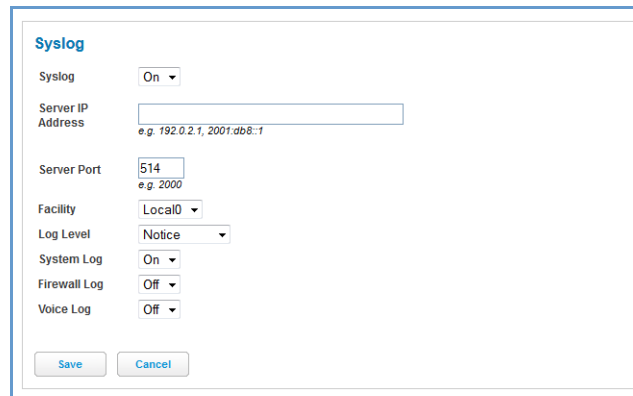

The screenshot shows a configuration window for Syslog. It includes a title bar 'Syslog' and several settings: 'Syslog' is set to 'On'; 'Server IP Address' is an empty text box with a hint 'e.g. 192.0.2.1, 2001:db8::1'; 'Server Port' is '514' with a hint 'e.g. 2000'; 'Facility' is 'Local0'; 'Log Level' is 'Notice'; 'System Log' is 'On'; 'Firewall Log' is 'Off'; and 'Voice Log' is 'Off'. At the bottom are 'Save' and 'Cancel' buttons.

- ◆ You can enable or disable the Syslog client dynamically. When enabled, it will report any appropriate and previously unreported events.
- ◆ You can specify the Syslog server's address and port, if required, either in dotted decimal format or as a DNS name of up to 63 characters.
- ◆ You can specify the UNIX Syslog facility to use by selecting from the **Facility** drop-down menu.
- ◆ From the **Log Level** drop-down menu, you can select a level from a list organized in decreasing severity level: Emergency, Alert, Critical, Error, Warning, Notice, Info, or Debug.
- ◆ By toggling each event descriptor to either **On** or **Off**, you can determine which ones are logged and which are ignored.

You will need to install a Syslog client daemon program on your PC and configure it to report the events you specified in the Syslog configuration screen.

Click the [Save](#) button.

---

### Link: Event Notifications

When you click the [Event Notifications](#) link, the Event Notifications page appears.

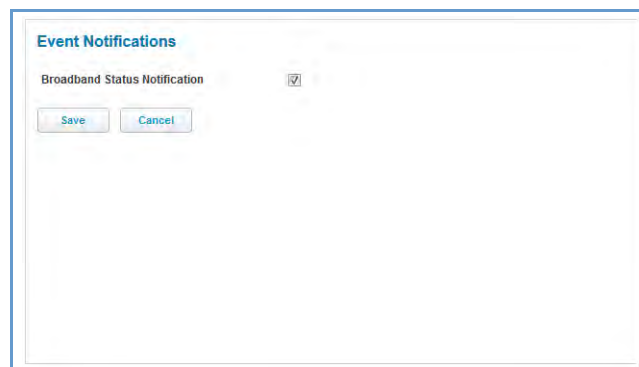

The screenshot shows a configuration window for Event Notifications. It has a title bar 'Event Notifications' and a single checkbox labeled 'Broadband Status Notification' which is checked. At the bottom are 'Save' and 'Cancel' buttons.

- ◆ If you select the **Broadband Status Notification** checkbox, the device will alert users on your network if the connection to the Internet should fail. In that event, troubleshooting suggestions will display.

---

## Link: NAT Table

When you click the [NAT Table](#) link, the NAT Table page appears.

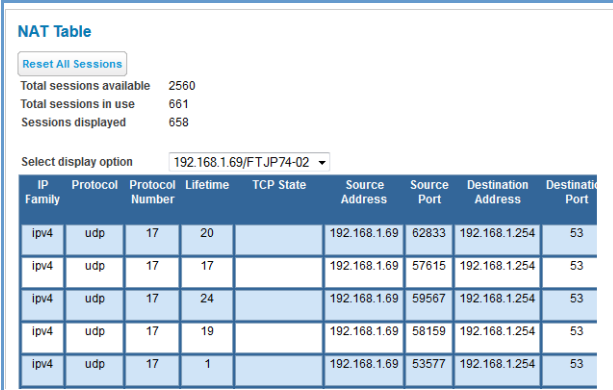

The screenshot shows the NAT Table page with the following statistics:

- Reset All Sessions (button)
- Total sessions available: 2560
- Total sessions in use: 661
- Sessions displayed: 658

A dropdown menu for 'Select display option' is set to '192.168.1.69/FTJP74-02'. Below it is a table of NAT sessions:

IP Family	Protocol	Protocol Number	Lifetime	TCP State	Source Address	Source Port	Destination Address	Destination Port
IPv4	udp	17	20		192.168.1.69	62833	192.168.1.254	53
IPv4	udp	17	17		192.168.1.69	57615	192.168.1.254	53
IPv4	udp	17	24		192.168.1.69	59567	192.168.1.254	53
IPv4	udp	17	19		192.168.1.69	58159	192.168.1.254	53
IPv4	udp	17	1		192.168.1.69	53577	192.168.1.254	53

The NAT Table page displays the network address translation sessions in use by the NVG599 device. You can use the drop-down menu to limit the displayed sessions to selected IP addresses.

To refresh all the sessions displayed, click the [Reset](#) button.





---

## CHAPTER 3      Basic Troubleshooting

This chapter gives some simple suggestions for troubleshooting problems with your NVG599 VDSL2 Gateway's initial configuration. This chapter covers the following topics:

- ◆ Status Indicator Lights on [page 88](#)
- ◆ Factory Reset Switch on [page 95](#)
- ◆ Event Log Messages on [page 96](#)

Before troubleshooting, make sure you have:

- ◆ Read this guide
- ◆ Plugged in all the necessary cables
- ◆ Set your PC's TCP/IP controls to obtain an IP address automatically



## Status Indicator Lights

The first step in troubleshooting is to check the status indicator lights (LEDs) in the order outlined below.

### ARRIS NVG599 VDSL2 Gateway Status Indicator Lights

#### Side View

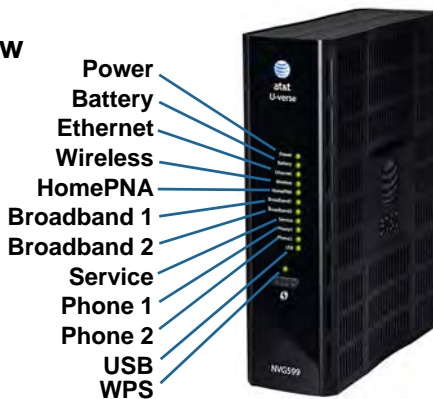

LED	Activity
<b>Power</b>	<p><b>Solid Green</b> = The device is powered.</p> <p><b>Flashing Green</b> = A power-on self-test (POST) is in progress</p> <p><b>Flashing Red</b> = A POST failure (not bootable) or device malfunction occurred.</p> <p><b>Flashing Amber</b> = Firmware upgrade in progress (see below)</p> <p>Off = The unit has no AC power. If the battery is in use, the Battery LED will indicate battery status, and all other LEDs will be off.</p>
<b>Power during Firmware Upgrade</b>	<p>During the software installation, you will lose Internet and phone service. The LEDs will function as follows:</p> <ol style="list-style-type: none"> <li>As firmware is being loaded into flash, the LEDs operate normally.</li> <li>During the firmware upgrade, which takes a few minutes, the Power LED will flash amber (flash writing to memory), and all other LEDs are off.</li> <li>The NVG599 restarts automatically. As the device reboots, the LEDs display power-on behavior.</li> </ol>
<b>All during Boot process</b>	<ul style="list-style-type: none"> <li>Power LED = <b>Flashing Green</b></li> <li>All other LEDs = Off</li> </ul> <p>If the device does not boot and fails its self-test or fails to perform initial load of the bootloader:</p> <ul style="list-style-type: none"> <li>Power LED = <b>Flashing Red</b></li> <li>ALL other LEDs = Off</li> </ul> <p>If the device boots and then detects a failure: Power LED = <b>Flashing Green</b> starting POST, and then all LEDs will <b>flash red</b>, including Power LED.</p>
<b>Battery</b>	<p><b>Solid Green</b> = Battery in place but not being used.</p> <p><b>Flashing Green</b> = Battery charging.</p> <p><b>Solid Red</b> = Battery backup mechanism has a fault.</p> <p><b>Flashing Red</b> = Battery needs to be replaced.</p> <p><b>Solid Amber</b> = Battery in use.</p> <p><b>Flashing Amber</b> = Low battery.</p> <p>Off = No battery, or battery has no charge.</p>

LED	Activity
<b>Ethernet</b>	<p><b>Solid Green</b> = Powered device connected to the associated port (includes devices with wake-on-LAN capability where a slight voltage is supplied to the Ethernet connection).</p> <p><b>Flickering Green</b> = Activity seen from devices associated with the port. The flickering of the light is synchronized to actual data traffic.</p> <p><b>Off</b> = The device is not powered, or no cable or no powered devices are connected to the associated ports.</p>
<b>WiFi</b>	<p><b>Solid Green</b> = Wi-Fi is powered.</p> <p><b>Flickering Green</b> = Activity seen from devices connected via Wi-Fi. The flickering of the light is synchronized to actual data traffic.</p> <p><b>Off</b> = The device is not powered, or no powered devices are connected to the associated ports.</p>
<b>HomePNA</b>	<p><b>Solid Green</b> = Powered device connected to the associated port (includes devices with wake-on-LAN capability where a slight voltage is supplied to the Ethernet connection).</p> <p><b>Flickering Green</b> = Activity seen from devices associated with the port. The flickering of the light is synchronized to actual data traffic.</p> <p><b>Off</b> = The device is not powered, or no cable or no powered devices are connected to the associated ports.</p>
<b>Broadband 1**, 2</b>	<p><b>Solid Green</b> = Good broadband connection (good DSL sync or Gigabit Ethernet).</p> <p><b>Flashing Green</b> = Attempting broadband connection (DSL attempting sync).</p> <p><b>Flashing Green and Red</b> = If, after three consecutive minutes, the broadband connection fails to be established, the LED switches to <b>Flashing Green</b> alternating with a five second steady <b>Red</b> while attempting or waiting to establish a broadband connection. This pattern continues until the broadband connection is successfully established.</p> <p><b>Flashing Red</b> = No DSL signal on the line. This display is not used during times of temporary 'no tone' during the training sequence.</p> <p><b>Off</b> = The device is not powered.</p> <p><b>** Broadband 1 LED</b> is also the Gigabit Ethernet WAN LED when that is in play (and DSL is not).</p>
<b>Service</b>	<p><b>Solid Green</b> = IP connected. The device has a WAN IP address from DHCP or 802.1x authentication and the broadband connection is up.</p> <p><b>Flashing Green</b> = Attempting connection, attempting IEEE 802.1X authentication, or attempting to obtain DHCP information.</p> <p><b>Red</b> = Device attempted to become IP connected and failed (no DHCP response, 802.1x authentication failed, no IP address from IPCP, etc.). The <b>Red</b> state times out after two minutes, and the Service indicator light returns to the Off state.</p> <p><b>Off</b> = The device is not powered or the broadband connection is not present.</p>
<b>Phone 1, 2</b>	<p><b>Solid Green</b> = The associated VoIP line has been registered with a SIP proxy server.</p> <p><b>Flashing Green</b> = Indicates a telephone is off-hook on the associated VoIP line.</p> <p><b>Off</b> = VoIP not in use, line not registered, or NVG599 power off.</p>
<b>USB</b>	<p><b>Solid Green</b> = Powered device connected to the associated port (includes devices with wake-on-LAN capability where a slight voltage is supplied to the Ethernet connection).</p> <p><b>Flickering Green</b> = Activity seen from devices associated with the port. The flickering of the light is synchronized to actual data traffic.</p> <p><b>Off</b> = The device is not powered, no cable or no powered devices connected to the associated ports.</p>

LED	Activity
<p><b>WPS</b> (appears after using WPS button)</p> 	<p><b>Solid Green</b> = Wi-Fi Protected Setup has been completed successfully. LED should stay on for 5 minutes or until push button is pressed again.</p> <p><b>Flashing Green</b> = Continues for 2 minutes, indicating when WPS is broadcasting.</p> <p><b>Flashing Red</b> = Continues for 2 minutes, indicating a Session overlap was detected (possible security risk).</p> <p><b>Solid Red</b> = Error unrelated to security, such as failure to find a partner, or WPS is disabled. LED should stay solid red for 5 minutes or until push button is pressed again.</p> <p><b>Off</b> = The device is ready for WPS authentication.</p>

**Rear View**

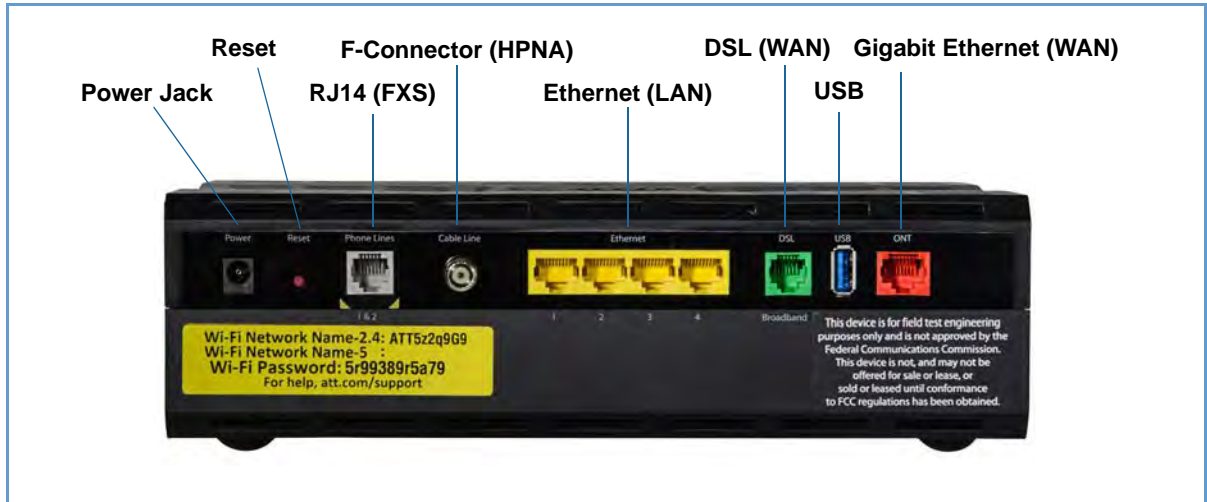

LED	Action
<p><b>Ethernet</b> <b>1,2 3,4</b></p>	<p><b>Flashing Amber</b> = A Gigabit Ethernet device is connected to each port.</p> <p><b>Solid Green</b> = A 10/100 Ethernet device is connected.</p> <p><b>Flickering Green</b> = Ethernet traffic activity.</p> <p><b>Off</b> = The device is not powered, or no powered devices are connected to the associated ports.</p>



**NOTE:**

The NVG599 supports two VoIP lines over one RJ11 VoIP port. In order to connect two phone lines the supplied inner/outer pair splitter adapters must be attached to the RJ11 VoIP port in order to terminate both lines. This is a special-purpose splitter. You must only use the inner/outer pair splitter adapters supplied by AT&T.



## LED Function Summary Matrix

<b>Power</b>	<b>Solid Green</b> = The device is powered.	<b>Flashing Green</b> = A power-on self-test (POST) is in progress.	<b>Orange/Amber</b> = Firmware upgrade (see <a href="#">“Power during Firmware Upgrade” on page 88</a> )	<b>Flashing Red</b> = A POST failure (not bootable) or device malfunction occurred. * When the device encounters a POST failure, all indicator lights on the front of the device continuously flash.	<b>Off</b> = The unit has no AC power.
<b>Battery</b>	<b>Solid Green</b> = Battery in place but not being used.	<b>Flashing Green</b> = Battery charging.	<b>Solid Amber</b> = Battery in use. <b>Flashing Amber</b> = Low battery.	<b>Solid Red</b> = Battery backup mechanism has a fault. <b>Flashing Red</b> = Battery needs to be replaced.	<b>Off</b> = No battery or battery has no charge. <b>Cycle between all colors</b> = Battery conducting self-test.
<b>Ethernet</b>	<b>Solid Green</b> = Powered device connected to the associated port (includes devices with wake-on-LAN capability where a slight voltage is supplied to the Ethernet connection).	<b>Flashing Green</b> = Activity seen from devices associated with the port. The flickering of the light is synchronized to actual data traffic.			<b>Off</b> = The device is not powered, no cable or no powered devices connected to the associated ports.
<b>WiFi</b>	<b>Solid Green</b> = Wi-Fi is powered.	<b>Flashing Green</b> = Activity seen from devices connected via Wi-Fi. The flickering of the light is synchronized to actual data traffic.			<b>Off</b> = The device is not powered or no powered devices connected to the associated ports.
<b>HomePNA</b>	<b>Solid Green</b> = Powered device connected to the associated port (includes devices with wake-on-LAN capability where a slight voltage is supplied to the Ethernet connection).	<b>Flickering Green</b> = Activity seen from devices associated with the port. The flickering of the light is synchronized to actual data traffic.			<b>Off</b> = The device is not powered, no cable or no powered devices connected to the associated ports.

<p><b>Broadband 1**, 2</b></p>	<p><b>Solid Green</b> = Good broadband connection (i.e., good DSL Sync). ** <b>Broadband 1 LED</b> is also the Gigabit ethernet WAN LED when that is in play (and DSL is not).</p>	<p><b>Flashing Green</b> = Attempting broadband connection (i.e., DSL attempting sync).</p>	<p><b>Flashing Green &amp; Red</b> = If the broadband connection fails to be established for more than three consecutive minutes the LED switches to <b>Flashing Green</b> when attempting or waiting to establish a broadband connection alternating with a five second steady <b>Red</b>. This pattern continues until the broadband connection is successfully established.</p>	<p><b>Flashing Red</b> = No DSL signal on the line. This is only used when there is no signal, not during times of temporary 'no tone' during the training sequence.</p>	<p><b>Off</b> = The device is not powered.</p>
<p><b>Service</b></p>	<p><b>Solid Green</b> = IP connected (The device has a WAN IP address from DHCP or 802.1x authentication and the broadband connection is up).</p>	<p><b>Flashing Green</b> = Attempting PPP connection. Attempting IEEE 802.1X authentication or attempting to obtain DHCP information.</p>		<p><b>Red</b> = Device attempted to become IP connected and failed (no DHCP response, 802.1x authentication failed, no IP address from IPCP, etc.). The Red state times out after two minutes and the Service indicator light returns to the Off state.</p>	<p><b>Off</b> = The device is not powered or the broadband connection is not present.</p>
<p><b>Phone 1, 2</b></p>	<p><b>Solid Green</b> = The associated VoIP line has been registered with a SIP proxy server.</p>	<p><b>Flashing Green</b> = Indicates a telephone is off-hook on the associated VoIP line.</p>			<p><b>Off</b> = VoIP not in use, line not registered or NVG599 power off.</p>

<b>USB</b>	<b>Solid Green</b> = Powered device connected to the associated port (includes devices with wake-on-LAN capability where a slight voltage is supplied to the Ethernet connection).	<b>Flickering Green</b> = Activity seen from devices associated with the port. The flickering of the light is synchronized to actual data traffic.			<b>Off</b> = The device is not powered, no cable or no powered devices connected to the associated ports.
<b>WPS</b>	<b>Solid Green</b> = Wi-Fi Protected Setup has been completed successfully. It should stay on for 5 minutes or until push button is pressed again.	<b>Flashing Green</b> = Indicates when WPS is broadcasting.	<b>Solid Red</b> = Error unrelated to security, such as failed to find any partner, or protocol prematurely aborted. It should stay Solid Red for 5 min or until push button is pressed again.	<b>Flashing Red</b> = Session overlap detected (possible security risk) in Scenario.	<b>Off</b> = WPS is ready for WPS authentication.

If a status indicator light does not look correct, look for these possible problems:

<b>LED Not Lit</b>	<b>Possible Problems</b>
<b>Power</b>	<ul style="list-style-type: none"><li>◆ Make sure the power adapter is plugged into the DSL modem properly.</li><li>◆ Try a known good wall outlet.</li><li>◆ If a power strip is used, make sure it is switched on.</li></ul>
<b>Broadband</b>	<ul style="list-style-type: none"><li>◆ Make sure that any telephone has a microfilter installed.</li><li>◆ Make sure that you are using the correct cable. The DSL cable is the thinner standard telephone cable and is labeled "Data Cable."</li><li>◆ Make sure the DSL cable is plugged into the correct wall jack.</li><li>◆ Make sure the DSL cable is plugged into the DSL port on the DSL modem.</li><li>◆ Make sure the DSL line has been activated at the central office DSLAM.</li><li>◆ Make sure the DSL modem is not plugged into a micro filter.</li></ul>
<b>Ethernet</b>	<ul style="list-style-type: none"><li>◆ Make sure the you are using the yellow Ethernet cable, not the DSL cable. The Ethernet cable is thicker than the standard telephone cable.</li><li>◆ Make sure the Ethernet cable is securely plugged into the Ethernet jack on the PC.</li><li>◆ Make sure the Ethernet cable is securely plugged into the Ethernet port on the DSL modem.</li><li>◆ Make sure you have Ethernet drivers installed on the PC.</li><li>◆ Make sure the PC's TCP/IP properties for the Ethernet network control panel are set to obtain an IP address via DHCP.</li><li>◆ Make sure the PC has obtained an address in the 192.168.1.x range. (You may have changed the subnet addressing.)</li><li>◆ Make sure the PC is configured to access the Internet over a LAN.</li><li>◆ Disable any installed network devices (Ethernet, HomePNA, wireless) that are not being used to connect to the DSL modem.</li></ul>

---

## Factory Reset Switch

Lose your access code? This section shows how to use the factory reset switch to reset the NVG599 so that you can access the configuration screens once again.

---



**NOTE:**

Keep in mind that all of your settings will need to be reconfigured.

---

If you don't have an access code, the only way to access the NVG599 is to follow these steps:

1. Referring to the diagram below, find the round Reset switch opening.



Reset Switch

2. Carefully insert the point of a pen or an unwound paperclip into the opening.
  - ◆ If you press the factory reset switch for **less than ten seconds**, the device will be rebooted. The indicator lights on the device will respond immediately and start blinking red within one second of the reset switch being pressed. The lights will blink whether the switch is still being pressed or has been released. The indicator lights will flash for a minimum of five seconds, even if the reset switch is released within five seconds of being pressed. If the reset switch is held for more than five seconds, it will continue to blink until released or until ten seconds have elapsed (see below).
  - ◆ If you press the factory reset switch for a **longer period of time**, the device will be reset to the factory default shipped settings. If the switch is held for ten seconds, the Power indicator continues to blink for an additional five seconds, and then the indicator lights return to their normal operating mode, whether or not the reset switch is still depressed.



## Log Event Messages

The system generates the log messages described in the following tables for events related to administrative access, system operation, DSL issues, packet access, or firewall issues.

---

### Administration-Related Log Messages

- |   |  |
|---|--|
| <b>1. administrative access attempted:</b>                          | This log message is generated whenever the user attempts to access the router's management interface.  |
| <b>2. administrative access authenticated and allowed:</b>          | This log message is generated whenever the user attempts to access the router's management interface and is successfully authenticated and allowed access to the management interface.   |
| <b>3. administrative access allowed:</b>                            | If for some reason, a customer does not want password protection for the management interface, this log message is generated whenever any user attempts to access the router's management interface and is allowed access to the management interface. |
| <b>4. administrative access denied - invalid user name:</b>         | This log message is generated whenever the user tries to access the router's management interface and authentication fails because of an incorrect username.   |
| <b>5. administrative access denied - invalid password:</b>          | This log message is generated whenever the user tries to access the router's management interface and authentication fails because of an incorrect password.   |
| <b>6. administrative access denied - telnet access not allowed:</b> | This log message is generated whenever the user tries to access the router's Telnet management interface from a public interface and is not permitted because remote management is disabled.   |
| <b>7. administrative access denied - web access not allowed:</b>    | This log message is generated whenever the user tries to access the router's HTTP management interface from a public interface and is not permitted because remote management is disabled.   |

---

### System Log Messages

- |  |  |
|--|--|
| <b>1. Received NTP Date and Time:</b>                  | This log message is generated whenever NTP receives date and time from the server. |
| <b>2. EN: IP up:</b>                                   | This log message is generated whenever Ethernet WAN comes up.                      |
| <b>3. WAN: Ethernet WAN1 activated at 100000 Kbps:</b> | This log message is generated when the Ethernet WAN link is up.                    |
| <b>4. Device Restarted:</b>                            | This log message is generated when the router has been restarted.                  |

---

### DSL Log Messages (Most Common)

<b>1. WAN: Data link activated at &lt;Rate&gt; Kbps (rx/tx)</b>	This log message is generated when the DSL link comes up.
<b>2. WAN: Data link deactivated</b>	This log message is generated when the DSL link goes down.
<b>3. RFC1483 up</b>	This log message is generated when RFC1483 link comes up.
<b>4. RFC1483-&lt;WAN-instance&gt;: IP down</b>	This log message is generated when RFC1483 link goes down.
<b>5. PPP: Channel &lt;ID&gt; up Dialout Profile name: &lt;Profile Name&gt;</b>	This log message is generated when a PPP channel comes up.
<b>6. PPP-&lt;WAN Instance&gt; down: &lt;Reason&gt;</b>	This log message is generated when a PPP channel goes down. The reason for the channel going down is displayed as well.

---

### Access-Related Log Messages

<b>1. permitted:</b>	This log message is generated whenever a packet is allowed to traverse router interfaces or allowed to access the router itself.
<b>2. attempt:</b>	This log message is generated whenever a packet attempts to traverse router interfaces or attempts to access the router itself.
<b>3. dropped - violation of security policy:</b>	This log message is generated whenever a packet, traversing the router or destined to the router itself, is dropped by the firewall because it violates the expected conditions.
<b>4. dropped - invalid checksum:</b>	This log message is generated whenever a packet, traversing the router or destined to the router itself, is dropped because of invalid IP checksum.
<b>5. dropped - invalid data length:</b>	This log message is generated whenever a packet, traversing the router or destined to the router itself, is dropped because the IP length is greater than the received packet length or if the length is too small for an IP packet.
<b>6. dropped - fragmented packet:</b>	This log message is generated whenever a packet, traversing the router, is dropped because it is fragmented, stateful inspection is turned ON on the packet's transmit or receive interface, and the deny-fragment option is enabled.
<b>7. dropped - cannot fragment:</b>	This log message is generated whenever a packet traversing the router is dropped because the packet cannot be sent without fragmentation, but the do-not-fragment bit is set.
<b>8. dropped - no route found:</b>	This log message is generated whenever a packet, traversing the router or destined to the router itself, is dropped because no route is found to forward the packet.
<b>9. dropped - invalid IP version:</b>	This log message is generated whenever a packet, traversing the router or destined to the router itself, is dropped because the IP version is not 4.
<b>10. dropped - possible land attack:</b>	This log message is generated whenever a packet, traversing the router or destined to the router itself, is dropped because the packet is a TCP/UDP packet and the source IP address and source port equals the destination IP address and destination port.
<b>11. TCP SYN flood detected:</b>	This log message is generated whenever a SYN packet destined to the router's management interface is dropped because the number of SYN-sent and SYN-receive messages exceeds one-half the number of allowable connections in the router.

**Access-Related Log Messages**

- 12. Telnet receive DoS attack - packets dropped:** This log message is generated whenever TCP packets destined to the router's Telnet management interface are dropped due to overwhelming receive data.
- 13. dropped - reassembly timeout:** This log message is generated whenever packets, traversing the router or destined to the router itself, are dropped because of reassembly timeout.
- 14. dropped - illegal size:** This log message is generated whenever packets, traversing the router or destined to the router itself, are dropped during reassembly because of illegal packet size in a fragment.

**Firewall Log Messages Detail (AT&T Requirement #841)**

Reason Enumeration ( C )	Log Text Representation	Why the Packet Was Logged
NM_LOGDROP_CAT_DIR	DIRECTION	Direction (generic)
NM_LOGDROP_CAT_DIR_UP	DIRECTION-UP	Upstream direction
NM_LOGDROP_CAT_DIR_DOWN	DIRECTION-DOWN	Downstream direction
NM_LOGDROP_CAT_ETH	ETH	Ethernet header (generic)
NM_LOGDROP_CAT_ETH_SRC_ADDR	ETH-SRC	Ethernet source MAC address
NM_LOGDROP_CAT_ETH_DST_ADDR	ETH-DST	Ethernet destination MAC address
NM_LOGDROP_CAT_ETH_PROT	ETH-PROTOCOL	Ethernet Protocol
NM_LOGDROP_CAT_ETH_VLAN	ETH-VLAN	Ethernet VLAN ID (where applicable)
NM_LOGDROP_CAT_IP	IP	IP header (generic)
NM_LOGDROP_CAT_IP_SRC	IP-SRC	IP source address
NM_LOGDROP_CAT_IP_DST	IP-DST	IP destination address
NM_LOGDROP_CAT_IP_PROT	IP-PROTOCOL	IP Protocol
NM_LOGDROP_CAT_IP_SPOOF	IP-SPOOF	IP address is spoofed (could not have been sent by a device legitimately with the address in the source address field)
NM_LOGDROP_CAT_IP_ILLEGAL	IP-ILLEGAL	IP address is illegal (either src or dest)
NM_LOGDROP_CAT_TCP	TCP	TCP header (generic)
NM_LOGDROP_CAT_TCP_SRC_PORT	TCP-SRC-PORT	TCP source port
NM_LOGDROP_CAT_TCP_DST_PORT	TCP-DST-PORT	TCP destination port
NM_LOGDROP_CAT_TCP_FLAGS	TCP-FLAGS	TCP flags field
NM_LOGDROP_CAT_UDP	UDP	UDP header (generic)
NM_LOGDROP_CAT_UDP_SRC_PORT	UDP-SRC-PORT	UDP source port
NM_LOGDROP_CAT_UDP_DST_PORT	UDP-DST-PORT	UDP destination port
NM_LOGDROP_CAT_ICMP	ICMP	ICMP packet (generic)
NM_LOGDROP_CAT_ICMP_TYPE	ICMP-TYPE	ICMP Type field
NM_LOGDROP_CAT_ICMP_CODE	ICMP-CODE	ICMP Code field
NM_LOGDROP_CAT_ICMP6	ICMPv6	ICMPv6 (generic)

**Firewall Log Messages Detail (AT&T Requirement #841)**

Reason Enumeration ( C )	Log Text Representation	Why the Packet Was Logged
NM_LOGDROP_CAT_POLICY	POLICY	Policy (generic). This currently includes filterset rules, restricted hosts, IPv6 profiles.
NM_LOGDROP_CAT_POLICY_INPUT	POLICY-INPUT-GEN-DISCARD	Packets destined for the CPE that are generically discarded (we specify the packets we <i>do</i> want; the rest are discarded.)
NM_LOGDROP_CAT_POLICY_WAN_MGMT	POLICY-WAN-MGMT-ACCESS	1) Trying to access CPE service from WAN side using LAN-side port 2) Trying to access CPE service from LAN side using WAN-side IP address 3) Trying to access CPE service from WAN side using IPv6
NM_LOGDROP_CAT_POLICY_ICMP_ECHO	POLICY-ICMP-ECHO	ICMP echo request discarded (more specific than NM_LOGDROP_CAT_ICMP_TYPE)
NM_LOGDROP_CAT_POLICY_UWC_RESTRICT	POLICY-UWC-RESTRICT	Packets dropped because of “Universal Wi-Fi Configuration” restrictions (currently unused)
NM_LOGDROP_CAT_POLICY_RESTRICTED_HOST	POLICY-RESTRICTED-HOST	Packets dropped because of “Restricted Host” feature (either content or time restrictions) (currently unused)
NM_LOGDROP_CAT_POLICY_WAN_DNS_QUERY	POLICY-WAN-SIDE-DNS-QUERY	DNS query packets received on a WAN interface
NM_LOGDROP_CAT_POLICY_WAN_DHCP_TO_SRV	POLICY-WAN-SIDE-DHCP-TO-SRVR	DHCP Discover request received on a WAN interface
NM_LOGDROP_CAT_POLICY_AH	POLICY-IPV6-AH	IPv6 packets with AH header (if so configured)
NM_LOGDROP_CAT_POLICY_ESP	POLICY-IPV6-ESP	IPv6 packets with ESP header (if so configured)
NM_LOGDROP_CAT_POLICY_DEP_HEADER	POLICY-DEPRECATED-HEADER	IPv6 packets with deprecated header (currently this only includes routing extension header type 0)
NM_LOGDROP_CAT_POLICY_CAPT_PORTAL	POLICY-CAPTIVE-PORTAL	[IPv6] packets dropped because captive portal is enabled.
NM_LOGDROP_CAT_FLOW	FLOW	Packets rejected as a result of analysis of multiple related packets (generic)
NM_LOGDROP_CAT_FLOW_FLOOD	FLOOD	Packets rejected because of flood-limiting
NM_LOGDROP_CAT_FLOW_PORTSCAN	PORTSCAN	Packets rejected because of port-scan detection
NM_LOGDROP_CAT_FLOW_DOS_OTHER	OTHER-DoS	Packets rejected because of other DoS detection. Currently this includes downstream flows that don't generate upstream responses - specifically addressing IPv6 Neighbor Discovery DoS attacks.



---

## CHAPTER 4      Command Line Interface

The NVG599 VDSL2 Gateway operating software includes a command line interface (CLI) that lets you access your NVG599 device over a Telnet connection. You can use the command line interface to enter and update the unit's configuration settings, monitor its performance, and restart it.

This chapter covers the following topics:

- ◆ [“Overview” on page 103](#)
- ◆ [“Starting and Ending a CLI Session” on page 105](#)
- ◆ [“Using the CLI Help Facility” on page 106](#)
- ◆ [“About SHELL Commands” on page 106](#)
- ◆ [“SHELL Commands” on page 107](#)
- ◆ [“About CONFIG Commands” on page 118](#)
- ◆ [“CONFIG Commands” on page 121](#)
- ◆ [“Debug Commands” on page 178](#)

**CONFIG Commands**

- ["Connection Commands" on page 121](#)
- ["Filter Set Commands" on page 124](#)
- ["Queue Commands" on page 129](#)
- ["IP Gateway Commands" on page 132](#)
- ["IPv6 Commands" on page 132](#)
- ["IP DNS Commands" on page 139](#)
- ["IP IGMP Commands" on page 139](#)
- ["NTP Commands" on page 142](#)
- ["Application Layer Gateway \(ALG\) Commands" on page 142](#)
- ["Dynamic DNS Commands" on page 143](#)
- ["Link Commands" on page 143](#)
- ["Management Commands" on page 146](#)
- ["Remote Access Commands" on page 148](#)
- ["Physical Interfaces Commands" on page 150](#)
- ["PPPoE Relay Commands" on page 157](#)
- ["NAT Pinhole Commands" on page 157](#)
- ["Security Stateful Packet Inspection \(SPI\) Commands" on page 158](#)
- ["VoIP Commands" on page 160](#)
- ["System Commands" on page 173](#)

---

## Overview

The CLI has two major command modes: **SHELL** and **CONFIG**. Summary tables that list the commands are provided below. Details of the entire command set follow in this section.

SHELL Commands	
Command	Description
arp	Send ARP request
clear	Erase all stored configuration information
clear_certificate	Remove an SSL certificate that has been installed
clear_https_certkey	Remove a secure HTTP certificate key value
clear_firewall_log	Empty the contents of the firewall event log
clear_log	Erase all stored log info in flash memory
configure	Configure unit's options
diagnose	Run self-test
download	Download config file
exit	Quit this shell
ffbb	Show the number of POST fault states
help	Get more: "help all" or "help help"
install	Download and program an image into flash
log	Add a message to the diagnostic log
loglevel	Report or change diagnostic log level
netstat	Show IP information
nslookup	Send DNS query for host
ping	Send ICMP echo request
quit	Quit this shell
6rd-check	Send a 6rd loopback packet to the border gateway
reset	Reset subsystems
restart	Restart unit
show	Show system information
start	Start subsystem
status	Show basic status of unit
telnet	Telnet to a remote host
traceroute	Send traceroute probes
upload	Upload config file
view	Show configuration information
who	Show who is using the shell
wps	Enter Wireless Protection Settings mode

---



CONFIG Commands	
Command Verbs	Description
delete	Delete configuration list data
help	Display a list of Help command options
save	Save configuration data
script	Print configuration data
set	Set configuration data
validate	Validate configuration settings
view	View configuration data
Keywords	
conn	Connection options
ip	TCP/IP protocol options
ip6	IPv6 protocol options
dns	Domain Name System options
gfs	Global filter set options
igmp	IGMP configuration options
ntp	Network Time Protocol options
gateway	Gateway options
link	WAN link options
management	System management options
physical	Physical interface options
dsl	DSL configuration options
enet	Ethernet options
pinhole	Pinhole options
pppoe-relay	Point to Point Protocol over Ethernet relay options
preferences	Shell environment preferences
queue	Queue options
security	Security (firewall) options
system	Gateway's system options
target-ad-insertion	Targeted Ad Insertion (TAI) options
voip	IP Voice (VoIP) configuration options
log	System activity logging options
Command Utilities	
top	Go to top level of configuration mode
quit	Exit from configuration mode; return to shell mode
exit	Exit from configuration mode; return to shell mode

---

## Starting and Ending a CLI Session

To start a CLI session, you need to open a Telnet connection from a workstation on your network.

You initiate a Telnet connection by issuing the following command from an IP host that supports Telnet, for example, a personal computer running a Telnet application such as NCSA Telnet.

```
telnet <ip_address>
```

You must know the IP address of the NVG599 device before you can make a Telnet connection to it. By default, your NVG599 uses 192.168.1.254 as the IP address for its LAN interface. You can use a Web browser to configure the NVG599 IP address.

### Logging In

The command line interface log-in process emulates the log-in process for a UNIX host. To log in, enter the user name and your password.

Entering the administrator password lets you display and update all NVG599 settings.

When you have logged in successfully, the command line interface lists the user name and the security level associated with the password you entered in the diagnostic log.

### Ending a CLI Session

You end a command line interface session by typing **quit** from the SHELL node of the command line interface hierarchy.

## Using the CLI Help Facility

The **help** command displays online help for SHELL and CONFIG commands. To display a list of the commands available to you from your current location within the command line interface hierarchy, type **help** or a question mark (?).

To obtain help for a specific CLI command, type **help <command>**. You can truncate the **help** command to **h** or a question mark when you request help for a CLI command.

## About SHELL Commands

Begin in SHELL mode when you start a CLI session. SHELL mode lets you perform the following tasks:

- ◆ Monitor NVG599 performance
- ◆ Display and reset NVG599 device statistics
- ◆ Issue administrative commands to restart NVG599 device functions

### SHELL Prompt

When you are in SHELL mode, the CLI prompt is the name of the NVG599 device followed by a right angle bracket (>). For example, if you open a CLI connection to the NVG599 device named "ARRIS-3000/9437188," you would see **ARRIS-3000/9437188>** as your CLI prompt.

### SHELL Command Shortcuts

You can truncate most commands in the CLI to their shortest unique string. For example, you can use the truncated command **q** in place of the full **quit** command to exit the CLI. However, you would need to enter **rese** for the **reset** command, since the first characters of **reset** are common to the **restart** command.

The only commands you cannot truncate are **restart** and **clear**. To prevent accidental interruption of communications, you must enter the **restart** and **clear** commands in their entirety.

You can use the Up and Down arrow keys to scroll backward and forward through recent commands you have entered. Alternatively, you can use the **!!** command to repeat the last command you entered.

---

## SHELL Commands

### Common Commands

---

#### **arp *nnn.nnn.nnn.nnn***

Sends an Address Resolution Protocol (ARP) request to match the *nnn.nnn.nnn.nnn* IP address to an Ethernet hardware address.

---

#### **clear [ *yes* ]**

Clears the configuration settings in an NVG599 device. You are prompted to confirm the **clear** command by entering **yes**.

---

#### **clear\_certificate**

Removes an SSL certificate that has been installed.

---

#### **clear\_https\_certkey**

Removes any Secure HTTP certificate key value installed in the NVG599.

---

#### **configure**

Puts the command line interface into Configure mode, which lets you configure your NVG599 with **config** commands. The **config** commands are described starting on [page 121](#).

---

#### **download [ *server\_address* ] [ *filename* ] [ *confirm* ]**

Installs a file of configuration parameters into the NVG599 device from a TFTP (Trivial File Transfer Protocol) server. The TFTP server must be accessible on your Ethernet network.

You can include one or more of the following arguments with the **download** command. If you omit arguments, the console prompts you for this information.

- ◆ The *server\_address* argument identifies the IP address of the TFTP server from which you want to copy the NVG599 configuration file.
- ◆ The *filename* argument identifies the path and name of the configuration file on the TFTP server.
- ◆ If you include the optional **confirm** keyword, the download begins as soon as all information is entered.

You can also download an SSL certificate file from a trusted certification authority (CA), on platforms that support SSL, as follows:

**download [-cert] [*server\_address*] [*filename*] [*confirm*]**

---

#### **ffbb**

Displays the number of times that the NVG599 device has entered a Power-On Self-Test (POST) fault state.

---

#### **install [ *server\_address* ] [ *filename* ] [ *confirm* ]**

Downloads a new version of the NVG599 operating software from a TFTP (Trivial File Transfer Protocol) server, validates the software image, and programs the image into the NVG599 memory. After you install new operating software, you must restart the NVG599 device.

The *server\_address* argument identifies the IP address of the TFTP server on which your NVG599 operating software is stored. The *filename* argument identifies the path and name of the operating software file on the TFTP server.

If you include the optional keyword **confirm**, you will not be prompted to confirm whether or not you want to perform the operation.

---

### **log message\_string**

Adds the message in the *message\_string* argument to the NVG599 diagnostic log.

---

### **loglevel [ level ]**

Displays or modifies the types of log messages you want the NVG599 to record. If you enter the **loglevel** command without the optional *level* argument, the command line interface displays the current log level setting.

You can enter the **loglevel** command with the *level* argument to specify the types of diagnostic messages you want to record. All messages with a level number equal to or greater than the level you specify are recorded. For example, if you specify log level 3, the diagnostic log will retain high-level informational messages (level 3), warnings (level 4), and failure messages (level 5).

Use the following values for the *level* argument:

- ◆ **1** or **low** – Low-level informational messages or greater; includes trivial status messages.
- ◆ **2** or **medium** – Medium-level informational messages or greater; includes status messages that can help monitor network traffic.
- ◆ **3** or **high** – High-level informational messages or greater; includes status messages that may be significant but do not constitute errors.
- ◆ **4** or **warning** – Warnings or greater; includes recoverable error conditions and useful operator information.
- ◆ **5** or **failure** – Failures; includes messages describing error conditions that may not be recoverable.

---

### **netstat -i**

Displays the IP interfaces for your NVG599.

---

### **netstat -r**

Displays the IP routes stored in your NVG599.

---

### **nslookup [ hostname | ip\_address ]**

Performs a domain name system lookup for a specified host.

- ◆ The *hostname* argument is the name of the host for which you want DNS information; for example, **nslookup klaatu**.
- ◆ The *ip\_address* argument is the IP address, in dotted decimal notation, of the device for which you want DNS information.

---

### **ping [-s size] [-c count] [ hostname | ip\_address ]**

Causes the NVG599 to issue a series of ICMP Echo requests for a device with the specified name or IP address.

- ◆ The *hostname* argument is the name of the device you want to ping; for example, **ping ftp.arris.com**.
- ◆ The *ip\_address* argument is the IP address, in dotted decimal notation, of the device you want to locate. If a host using the specified name or IP address is active, it returns one or more ICMP echo replies, confirming that it is accessible from your network.

- 
- ◆ The **-s size** argument lets you specify the size of the ICMP packet.
  - ◆ The **-c count** argument lets you specify the number of ICMP packets generated for the ping request. Values greater than 250 are truncated to 250.

You can use the **ping** command to determine whether a hostname or IP address is already in use on your network. You cannot use the **ping** command to ping the NVG599 device's own IP address.

---

## quit

Exits the NVG599 command line interface.

---

## 6rd-check [-s size] [-c count] conn\_name

Generates and sends 6rd (IPv6 Rapid Deployment) loopback packets to the 6rd gateway.

---

## reset arp

Clears the Address Resolution Protocol (ARP) cache on your unit.

---

## reset crash

Clears crash-dump information, which identifies the contents of the NVG599 registers at the point of system malfunction.

---

## reset dhcp server

Clears the DHCP lease table in the NVG599 device.

---

## reset enet [ all ]

Resets Ethernet statistics to zero. Resets individual LAN switch port statistics as well as wireless and WAN Ethernet statistics (where applicable).

---

## reset firewall-log

Rewinds the firewall log to the first entry.

---

## reset ipmap

Clears the IPMap table (NAT).

---

## reset log

Rewinds the diagnostic log display to the top of the existing NVG599 diagnostic log. The **reset log** command does not clear the diagnostic log. The next **show log** command will display information from the beginning of the log file.

---

## reset wan

This function resets WAN interface statistics.

---

---

## **restart [ seconds ]**

Restarts your NVG599 device. If you include the optional **seconds** argument, your NVG599 will restart when the specified number of seconds have elapsed. You must enter the complete **restart** command to initiate a restart.

---

## **show all-info**

Displays all settings currently configured in the NVG599 device.

---

## **show bridge interfaces**

Displays bridge interfaces maintained by the NVG599 device.

---

## **show bridge table**

Displays the bridging table maintained by the NVG599 device.

---

## **show config**

Dumps the ARRIS Gateway's configuration script just as the **script** command does in Configure mode.

---

## **show crash**

Displays the most recent crash information, if any, for your NVG599 device.

---

## **show dhcp server leases**

Displays the DHCP leases stored in RAM by your NVG599 device.

---

## **show dhcp client**

Displays the DHCP clients stored in RAM by your NVG599 device.

---

## **show dsl [ all ]**

Displays DSL port statistics, such as upstream and downstream connection rates and noise levels.

---

## **show dslf device-association**

Displays LAN devices that conform with the TR111 Gateway requirement. It displays IP address, manufacture OUI, and serial number.

---

## **show enet [ all ]**

Displays Ethernet interface statistics maintained by the NVG599 device. Supports display of individual LAN switch port statistics as well as WAN Ethernet statistics (where applicable).

### **Example:**

```
Ethernet driver full statistics - LAN
10/100/1000 Ethernet
Port Status: Link up
```

---

```
General:
  Transmit OK      : 253
  Receive OK       : 22
  Tx Errors        : 0
  Rx Errors        : 0

Receiver:
  Dropped Packets : 0

Transmitter:
  Collisions       : 0
  Dropped Packet   : 0

Upper Layers:
  Rx No Handler    : 0
  Rx No Message    : 0
  Rx Octets        : 4781
  Rx Unicast Pkts : 22
  Rx Multicast Pkts : 0
  Tx Discards      : 0
  Tx Octets        : 17204

10/100/1000 Ethernet port 1
Port Status: Link down

10/100/1000 Ethernet port 2
Port Status: Link up
Duplex: Full
Speed: 1000BASE-T
  Transmit OK      : 253
  Transmit unicastpkts : 0
  Tx Octets        : 16192
  Tx Collision     : 0
  Receive OK       : 24
  Receive unicastpkts : 0
  Receive errors   : 0
  Rx Octets        : 4781

10/100/1000 Ethernet port 3
Port Status: Link down

10/100/1000 Ethernet port 4
Port Status: Link down

HPNA port 5 (counter values include management traffic)
Port Status: Link up
Duplex: Full
Speed: 200 MBPS
  Transmit OK      : 1702
  Transmit unicastpkts : 1173
  Tx Octets        : 226117
  Tx Collision     : 0
  Receive OK       : 1168
  Receive unicastpkts : 1168
  Receive errors   : 0
  Rx Octets        : 202156

Ethernet driver statistics - Wireless
Port Status: Link down

Ethernet driver full statistics - PTM WAN
Port Status: Link down
```



```
Ethernet driver full statistics - WAN
10/100/1000 Ethernet
Port Status: Link down
Ethernet driver full statistics - 10/100 Ethernet
Port Status: Link up
Type: 100BASET Duplex: Full
General:
  Transmit OK           : 434
  Receive OK           : 267
  Tx Errors             : 0
  Rx Errors             : 0
Receiver:
  Incompl Packet Errors : 0
  No RBD's For Packet   : 0
  Carrier Sense Lost    : 0
  Deferred Replen       : 0
Transmitter:
  TX Retries           : 0
  Single Collisions    : 0
  No Buf For Packet    : 0
Upper Layers:
  Rx No Handler        : 0
  Rx No Message        : 0
  Rx Octets            : 30773
  Rx Unicast Pkts     : 267
  Rx Multicast Pkts   : 0
  Tx Discards          : 0
  Tx Octets            : 31692
10/100 Ethernet phy.enet.port
Port Status: Link up
Duplex: Full-duplex active
Speed: 100BASE-T
  Transmit OK           : 434
  Transmit unicastpkts : NA
  Receive OK           : 267
  Receive unicastpkts  : 267
```

---

## show enet tx-queue

```
"show enet tx-queue"
This is an output of what is should look like:
NOS/128600225699776/UNLOCKED> show enet tx-queue
No transmit software queue configured on Ethernet port 1
No transmit software queue configured on Ethernet port 2
No transmit software queue configured on Ethernet port 3
No transmit software queue configured on Ethernet port 4
No transmit software queue configured on Ethernet port 5
No transmit software queue configured on Ethernet port 6
Ethernet switch queue stats:
Port 1:
  TxQ1: 54257
  TxQ2: 0
```

---

```
TxQ3: 0
TxQ4: 508
Port 2:
TxQ1: 55767
TxQ2: 0
TxQ3: 0
TxQ4: 508
Port 3:
TxQ1: 0
TxQ2: 0
TxQ3: 0
TxQ4: 0
Port 4:
TxQ1: 0
TxQ2: 0
TxQ3: 0
TxQ4: 0
Port 5:
TxQ1: 92950
TxQ2: 0
TxQ3: 0
TxQ4: 508
```

---

## show group-mgmt

Displays the IGMP Snooping table. See [“IP IGMP Commands” on page 139](#) for detailed explanation.

---

## show ip arp

Displays the Ethernet address resolution table stored in your NVG599 device.

---

## show ip igmp

Displays the contents of the IGMP Group Address table and the IGMP Report table maintained by your NVG599 device.

---

## show ip interfaces

Displays the IP interfaces for your NVG599 device.

---

## show ip firewall

Displays firewall statistics.

---

## show ip lan-discovery

Displays the LAN Host Discovery table of hosts on the wired or wireless LAN, and whether or not they are currently online.

---

## show ip routes

Displays the IP routes stored in your NVG599 device.

---

## show ipmap

Displays IPMap table (NAT).

---

## **show ipv6 interfaces**

Displays IPv6 interfaces.

---

## **show ipv6 routes**

Displays the IPv6 route table.

---

## **show ipv6 neighbors**

Displays the IPv6 neighbor table.

---

## **show ipv6 dhcp server leases**

Displays the DHCPv6 server lease table.

---

## **show ipv6 statistics**

Displays IPv6 statistics information.

---

## **show log**

Displays blocks of information from the NVG599 diagnostic log. To see the entire log, you can repeat the **show log** command, or you can enter **show log all**.

---

## **show firewall-log**

Displays blocks of information from the NVG599 firewall log.

---

## **show memory [ all ]**

Displays memory usage information for your NVG599 device. If you include the optional **all** argument, your NVG599 will display a more detailed set of memory statistics.

---

## **show ptm**

Displays statistics information for each PTM session.

---

## **show post-results**

Displays Power-On Self-Test results.

---

## **show pppoe**

Displays status information for each PPPoE socket, such as the socket state, service names, and host ID values.

---

## **show rootcert**

Dumps the Subject line for the list of all the trusted root certificates for the 802.1x supplicant.

---

## **show rtsp**

Displays RTSP ALG session activity data.

---

---

---

## show status

Displays the current status of an NVG599 device, the device's hardware and software revision levels, a summary of errors encountered, and the length of time the device has been running since it was last restarted. Identical to the **status** command.

---

## show summary

Displays a summary of WAN, LAN, and gateway information.

---

## show vlan

Displays detail of VLAN status and statistics.

---

## show wireless [ all ]

Shows wireless status and statistics.

---

## show wireless clients [ MAC\_address ]

Displays details on connected clients, or more details on a particular client if the MAC address is added as an argument.

---

## show voip

Displays VoIP call statistics.

---

## show voiplog

Displays VoIP event logs.

---

## telnet [ hostname | ip\_address ] [ port ]

Lets you open a Telnet connection to the specified host through your NVG599 device.

- ◆ The **hostname** argument is the name of the device to which you want to connect, for example, **telnet ftp.arris.com**.
  - ◆ The **ip\_address** argument is the IP address, in dotted decimal notation, of the device to which you want to connect.
  - ◆ The **port** argument is the number of the port over which you want to open a Telnet session.
- 

## traceroute ( ip\_address | hostname )

Traces the routing path to an IP destination.

---

## upload [ server\_address ] [ filename ] [ confirm ]

Copies the current configuration settings of the NVG599 to a TFTP (Trivial File Transfer Protocol) server. The TFTP server must be accessible on your Ethernet network. The **server\_address** argument identifies the IP address of the TFTP server on which you want to store the NVG599 settings. The **filename** argument identifies the path and name of the configuration file on the TFTP server. If you include the optional **confirm** keyword, you will not be prompted to confirm whether or not you want to perform the operation.

---

## view config

Dumps the NVG599 device's configuration just as the **view** command does in Configure mode.

---

---

## who

Displays the names of the current shell and PPP users.

---

## wps

Enters the wireless WPS (Wi-Fi Protected Setup) mode.

### WPS Commands

The following commands are available in WPS mode:

---

## pushbutton

Sets the NVG599 device to WPS “pushbutton” mode, initiating protected setup.

---

## pin

Sets the NVG599 device to PIN mode, enabling authorized devices to be identified and added by MAC address personal identification number.

---

## list

Lists the WPS-ready client devices (enrollees) known to the NVG599.

---

## self-pin

Displays the NVG599's own Personal Identification Number (PIN) value.

### WAN Commands

---

## atmping vccn [ segment | end-to-end ]

Lets you check the ATM connection reachability and network connectivity. This command sends five Operations, Administration, and Maintenance (OAM) loopback calls to the specified VPI/VCI destination. There is a five second total timeout interval.

Use the **segment** argument to ping a neighbor switch.  
Use the **end-to-end** argument to ping a remote end node.

---

## reset dhcp client release [ vcc-id ]

Releases the DHCP lease the NVG599 device is currently using to acquire the IP settings for the specified DSL port. The **vcc-id** identifier is an “index” letter in the range B-I, and does not directly map to the VCC in use. Enter the **reset dhcp client release** command without the variable to see the letter assigned to each virtual circuit.

---

## reset dhcp client renew [ vcc-id ]

Renews the DHCP lease the NVG599 device is currently using to acquire the IP settings for the specified DSL port. The **vcc-id** identifier is an “index” letter in the range B-I, and does not directly map to the VCC in use. Enter the **reset dhcp client release** command without the variable to see the letter assigned to each virtual circuit.

---

---

---

## **reset dsl**

Resets any open DSL connection.

---

## **reset ppp vccn**

Resets the point-to-point connection over the specified virtual circuit. This command only applies to virtual circuits that use PPP framing.

---

## **show atm [all]**

Displays ATM statistics for the NVG599 device. The optional **all** argument displays a more detailed set of ATM statistics.

---

## **show ppp [{ stats | lcp | ipcp }]**

Displays information about open PPP links. You can display a subset of the PPP statistics by including an optional **stats**, **lcp**, or **ipcp** argument for the **show ppp** command.

---

## **start ppp vccn**

Opens a PPP link on the specified virtual circuit.

## About CONFIG Commands

You can reach the Configuration mode of the command line interface by typing **configure** (or any truncation of **configure**, such as **con** or **config**) at the CLI SHELL prompt.

### CONFIG Mode Prompt

When you are in CONFIG mode, the CLI prompt consists of the name of the NVG599 device followed by your current node in the hierarchy and two right angle brackets (>>). For example, when you enter CONFIG mode (by typing **config** at the SHELL prompt), the prompt **ARRIS-3000/9437188 (top)>>** reminds you that you are at the top of the CONFIG hierarchy. If you move to the IP node in the CONFIG hierarchy (by typing **ip** at the CONFIG prompt), the prompt changes to **ARRIS-3000/9437188 (ip)>>** to identify your current location.

Some CLI commands are not available until certain conditions are met. For example, you must enable IP for an interface before you can enter IP settings for that interface.

### Navigating the CONFIG Hierarchy

- ◆ **Moving from CONFIG to SHELL** — You can navigate from anywhere in the CONFIG hierarchy back to the SHELL level by entering **quit** at the CONFIG prompt and pressing Enter.

```
ARRIS-3000/9437188 (top)>> quit
ARRIS-3000/9437188 >
```

- ◆ **Moving from top to a subnode** — You can navigate from the top node to a subnode by entering the node name (or the significant letters of the node name) at the CONFIG prompt and pressing RETURN. For example, you move to the IP subnode by entering **ip** and pressing Enter.

```
ARRIS-3000/9437188 (top)>> ip
ARRIS-3000/9437188 (ip)>>
```

As a shortcut, you can enter the significant letters of the node name in place of the full node name at the CONFIG prompt. The significant characters of a node name are the letters that uniquely identify the node. For example, since only one CONFIG node starts with “b,” you could enter the letter “b” to move to the bridge node.

- ◆ **Jumping down several nodes at once** — You can jump down several levels in the CONFIG hierarchy by entering the complete path to a node.
- ◆ **Moving up one node** — You can move up through the CONFIG hierarchy one node at a time by entering the **up** command.
- ◆ **Jumping to the top node** — You can jump to the top level from anywhere in the CONFIG hierarchy by entering the **top** command.
- ◆ **Moving from one subnode to another** — You can move from one subnode to another by entering a partial path that identifies how far back to climb.
- ◆ **Moving from any subnode to any other subnode** — You can move from any subnode to any other subnode by entering a partial path that starts with a top-level CONFIG command.
- ◆ **Scrolling backward and forward through recent commands** — You can use the Up and Down arrow keys to scroll backward and forward through recent commands you have entered. When the command you want appears, press Enter to execute it.

### Entering Commands in CONFIG Mode

CONFIG commands consist of keywords and arguments. Keywords in a CONFIG command specify the action you want to take or the entity on which you want to act. Arguments in a CONFIG command specify the values appropriate to your site. For example, the following CONFIG command consists of three keywords (**ip**, **dns** and **domain-name**) and one argument (**domain\_name\_value**).

---

```
set ip dns domain-name domain_name_value
```

When you use the command to configure your NVG599 device, you would replace the argument with a value appropriate to your site.

For example:

```
set ip dns domain-name arris.com
```

### Guidelines: CONFIG Commands

The following table provides guidelines for entering and formatting CONFIG commands.

Command Component	Rules for Entering CONFIG Commands
Command Verbs	CONFIG commands must start with a command verb ( <b>set</b> , <b>view</b> , <b>delete</b> ). You can truncate CONFIG verbs to three characters ( <b>set</b> , <b>vie</b> , <b>del</b> ). CONFIG verbs are case-insensitive. You can enter <b>SET</b> , <b>Set</b> , or <b>set</b> .
Keywords	Keywords are case-insensitive. You can enter <b>Ethernet</b> , <b>ETHERNET</b> , or <b>ethernet</b> as a keyword without changing its meaning. Keywords can be abbreviated to the length that they are differentiated from other keywords.
Argument Text	Text strings can be as many as 64 characters long, unless otherwise specified. In some cases they may be as long as 255 bytes. Special characters are represented using backslash notation. Text strings can be enclosed in double (") or single (') quotation marks. If the text string includes an embedded space, it must be enclosed in quotation marks. Special characters are represented using backslash notation.
Numbers	Enter numbers as integers, or in hexadecimal format, where so noted.
IP Addresses	Enter IP addresses in dotted decimal notation (0 to 255).

If a command is ambiguous or miskeyed, the CLI prompts you to enter additional information. For example, you must specify which virtual circuit you are configuring when you are setting up an NVG599 device.

### Displaying Current Gateway Settings

You can use the **view** command to display the current CONFIG settings for your NVG599. If you enter the **view** command at the top level of the CONFIG hierarchy, the CLI displays the settings for all enabled functions. If you enter the **view** command at an intermediate node, you see settings for that node and its subnodes.

### Step Mode: A CLI Configuration Technique

The NVG599 command line interface includes a step mode to automate the process of entering configuration settings. When you use the CONFIG step mode, the command line interface prompts you for all required and optional information. You can then enter the configuration values appropriate for your site without having to enter complete CLI commands.

When you are in step mode, the command line interface prompts you to enter required and optional settings. If a setting has a default value or a current setting, the command line interface displays the default value for the command in parentheses. If a command has a limited number of acceptable values, those values are presented in brackets, with each value separated by a vertical line.



For example, the following CLI step command indicates that the default value is **off** and that valid entries are limited to **on** and **off**.

```
option (off) [on | off]: on
```

You can accept the default value for a field by pressing the Enter key. To use a different value, type it and press Enter.

You can enter the CONFIG step mode by entering **set** from the top node of the CONFIG hierarchy. You can enter step mode for a particular service by entering **set service\_name**. In stepping set mode (press Control-X Enter) to exit. For example:

```
ARRIS-3000/9437188 (top)>> set system
...
system
  name ("ARRIS-3000/9437188"): Mycroft
  Diagnostic Level (High): medium
Stepping mode ended.
```

### Validating Your Configuration

You can use the **validate** CONFIG command to make sure that your configuration settings have been entered correctly. If you use the **validate** command, the NVG599 device verifies that all required settings for all services are present and that settings are consistent.

```
ARRIS-3000/9437188 (top)>> validate
Error: Subnet mask is incorrect
Global Validation did not pass inspection!
```

You can use the **validate** command to verify your configuration settings at any time. Your NVG599 device automatically validates your configuration any time you save a modified configuration.

---

## CONFIG Commands

This section describes the keywords and arguments for the various CONFIG commands.

### Connection Commands

The **conn** commands are used to create connections, for example, a WAN or LAN connection. There may be more than one of each depending on your model. The **name** commands correspond to the system object IDs (OIDs), but you can name them yourself.

---

#### **set conn name *name* link-oid *value***

Sets the connection named *name* to point to an associated link specified by the **link-oid** value.

---

#### **set conn name *name* type [ **static** | **dhcpc** | **ppp** ]**

Specifies whether the **type** of the connection named *name* is static, DHCP, or PPP.

---

#### **set conn name *name* side [ **lan** | **wan** ]**

Specifies whether this connection is LAN- or WAN-side. A connection can be either **lan** or **wan**.

---

#### **set conn name *name* lan-type [ **private** | **public** | **public-delegated** ]**

Specifies whether this connection's LAN is private, public, or public-delegated. The default is **private**, the usual type of local network.

---

#### **set conn name *name* dhcp-server-enable [ **on** | **off** ]**

Turns the DHCP server for this connection **on** or **off**. The DHCP server can be enabled per connection. The default is **on**.

---

#### **set conn name *name* mcast-forwarding [ **off** | **on** ]**

Turns IP IGMP multicast forwarding for this connection **off** or **on**. The default is **off**.

---

#### **set conn name *name* rip-send [ **off** | **v1** | **v2** | **v1-compat** | **v2-md5** ]**

Specifies whether the device should use Routing Information Protocol (RIP) broadcasts to advertise its routing tables to other gateways. RIP Version 2 (RIP-2) is an extension of the original Routing Information Protocol (RIP-1) that expands the amount of useful information in the RIP packets. While RIP-1 and RIP-2 share the same basic algorithms, RIP-2 supports several additional features, including inclusion of subnet masks in RIP packets and implementation of multicasting instead of broadcasting (which reduces the load on hosts that do not support routing protocols). RIP-2 with MD5 authentication is an extension of RIP-2 that increases security by requiring an authentication key when routes are advertised. Depending on your network needs, you can configure your device to support RIP-1, RIP-2, or RIP-2MD5.

If you specify v2-MD5, you must also specify a rip-send-key. Keys are ASCII strings with a maximum of 31 characters, and must match the other gateway keys for proper operation of MD5 support. The default is **off**.

---

#### **set conn name *name* rip-receive [ **off** | **v1** | **v2** | **v1-compat** | **v2-md5** ]**

Specifies whether the device should use Routing Information Protocol (RIP) broadcasts to update its routing tables with information received from other gateways on the other side of the connection. If you specify **v2-md5**, you must also specify a rip-receive-key. Keys are ASCII strings with a maximum of 31 characters, and must match the other gateway keys for proper operation of MD5 support. The default is **off**.

---

## set conn name *name* icmp-echo-drop [ off | on ]

If set to **on**, drops echo-requests received on the particular interface. The default is **off**.

---

## set conn name *name* icmp-err-suppress [ off | on ]

An additional option to suppress ICMP error messages on WAN IP interfaces. The default is **off**.

---

## set conn name *name* static ipaddr *ipaddr*

Specifies a static IP address when the connection **type** has been set to **static**. The default is 192.168.1.254.



**NOTE:**

You must also set the gateway address OR turn it off, otherwise the settings cannot be saved. See [“IP Gateway Commands” on page 132](#).

---

### Example:

```
NOS/128600225634272/conf
Config Mode v1.3
NOS/128600225634272 (top)>> conn
NOS/128600225634272 (conn)>> set
    conn
(conn) node list ...
    "LAN"
    "WAN"
Select (name) node to modify from list,
or enter new (name) to create.
conn name (?):
    name "LAN"
        link-oid ("LAN") [ LAN | WAN | PPPoE | ]:
        type (static) [ static | dhcpc | ppp ]:
        side (lan) [ lan | wan ]:
        lan-type (private) [ private | public | public-delegated ]:
        mcast-forwarding (off) [ off | on ]:
        rip-send (off) [ off | v1 | v2 | v1-compatible | v2-md5 ]:
        rip-receive (off) [ off | v1 | v2 | v1-compatible | v2-md5 ]:
        fs-egress ("") [ Security | QosUpstream | WanEgress | ]:
        fs-ingress ("") [ Security | QosUpstream | WanEgress | ]:
        static
            ipaddr ("192.168.1.254"):
            netmask ("255.255.255.0"):
        dhcp-server-enable (on) [ off | on ]:
        dhcp-server
            start-addr ("192.168.1.64"):
            end-addr ("192.168.1.253"):
            lease-time (01:00:00:00):
            subnet-order (1) [ 1 - 8 ]:
            gen-option
(gen-option) node list ...
Select (name) node to modify from list,
or enter new (name) to create.
    gen-option name (?):
        option-group
(option-group) node list ...
Select (name) node to modify from list,
or enter new (name) to create.
        option-group name (?):
```

---

```

    filterset
(filterset) node list ...
Select (name) node to modify from list,
or enter new (name) to create.
    filterset name (?):
name "WAN"
link-oid ("WAN") [ LAN | WAN | PPPoE | ]:
type (dhcp) [ static | dhcp | ppp ]: static
side (wan) [ lan | wan ]:
mcast-forwarding (off) [ off | on ]:
nat-enable (on) [ off | on ]:
rip-receive (off) [ off | v1 | v2 | v1-compat | v2-md5 ]:
icmp-echo-drop (on) [ off | on ]:
icmp-err-suppress (off) [ off | on ]:
fs-egress ("WanEgress") [ Security | QosUpstream | WanEgress | ]:
fs-ingress ("") [ Security | QosUpstream | WanEgress | ]:
static
ipaddr (""): 10.3.53.100
netmask ("255.255.255.0"):
NOS/128600225634272 (conn)>> set ip gateway address 10.3.53.1
NOS/128600225634272 (conn)>> save
If you do not want the gateway use this command to turn it off:
set ip gateway enable off

```

---

### **set conn name *name* static netmask *netmask***

Specifies a static netmask when the connection **type** has been set to **static**. The default is 255.255.255.0.

---

### **set conn name *name* dhcp-server start-addr *ipaddr***

If **dhcp-server-enable** is set to **on**, specifies the first address in the DHCP address range. The NVG599 can reserve a sequence of up to 253 IP addresses within a subnet, beginning with the specified address for dynamic assignment. The default is 192.168.1.64

---

### **set conn name *name* dhcp-server end-addr *ipaddr***

If **dhcp-server-enable** is set to **on**, specifies the last address in the DHCP address range. The default is 192.168.1.253

---

### **set conn name *name* dhcp-server lease-time *seconds***

If **dhcp-server-enable** is set to **on**, specifies the default length for DHCP leases issued by the NVG599. Lease time is in seconds. Default is **3600**.

---

### **set conn name *name* dhcp-server subnet-order [1... 8]**

If **dhcp-server-enable** is set to **on**, specifies the order in which to address the first of 8 possible subnets. Ordinarily, this is the first one, the default **1**.

---

### **set conn name *name* nat-enable [ on | off ]**

Specifies whether you want the NVG599 device to use network address translation (NAT) when communicating with remote gateways. NAT lets you conceal details of your network from remote gateways. It also permits all LAN devices to share a single IP address. By default, address NAT is turned **on**.

---

**set conn name *name* dhcp-client discover-time *seconds***

The DHCP client parameters appear when the connection type has been set to **dhcp**. The **discover-time** value is in seconds; the default is **30**.

---

**set conn name *name* dhcp-client dns-enable [ on | off ]**

Allows you to enable or disable the default behavior of acting as a DNS proxy. The default is **on**.

---

**set conn name *name* dhcp-client dns-override [ off | on ]**

Allows you to enable or disable overriding default DNS behavior. The default is **off**.

---

**set conn name *name* dhcp-client vendor-class *string***

The **vendor-class** default information varies by model and components. This is information that identifies the unit.

---

**set conn name *name* fs-egress *filterset\_name***

Attaches a user filterset to a connection, which is applied to transmitted packets. See [“Filter Set Commands” on page 124](#).

---

**set conn name *name* fs-ingress *filterset\_name***

Attaches a user filter set to a connection, which is applied to received packets. See [“Filter Set Commands” on page 124](#).

### Filter Set Commands

Filter sets provide packet filtering and QoS configuration. Packets are identified by characteristics that allow QoS and forwarding decisions to be made. These characteristics can be at the MAC layer, IP layer, TCP | UDP | ICMP layer(s), or (in applicable circumstances) 802.1q/p (VLAN-tagging) layer.

Your NVG599 device is capable of adding and stripping 802.1Q tags to and from frames before transmission on its LAN interfaces. See also [“Link Commands” on page 143](#) for more information.

A maximum of 8 filter sets are supported. Each filter set can have up to 8 rules configured. A maximum 8 egress queues are supported. Each queue can have up to 8 entries.

A filter set rule identifies packet attributes to match with its **match** parameters. It acts on these packets using its **default action** parameters.

---

**set filterset name *filterset\_name* rule *number* order *number***

Determines order of execution of filter set rules (1 before 2, etc). If **order** is unspecified, the value of **order** is set to 1 more than the last order in the filter set. If **order** is set to an already existing order value, order values of other rules are incremented automatically.

---

**set filterset name *filterset\_name* rule *number* enable [ on | off ]**

Dynamically enables or disables the specified filter set rule.

---

---

**set filterset name *filterset\_name* rule *number* match-eth-proto *number***

Matches Ethernet protocol field to the supplied value.

---

**set filterset name *filterset\_name* rule *number* match-eth-length *number***

Matches Ethernet length field to the supplied value.

---

**set filterset name *filterset\_name* rule *number* match-eth-p-bits *number***

Matches VLAN priority bits.

---

**set filterset name *filterset\_name* rule *number* match-eth-vid *number***

Matches VLAN ID number.

---

**set filterset name *filterset\_name* rule *number* match-eth-src-mac-addr  
*mac\_address***

Matches supplied source MAC address field.

---

**set filterset name *filterset\_name* rule *number* match-eth-dst-mac-addr  
*mac\_address***

Matches supplied destination MAC address field.

---

**set filterset name *filterset\_name* rule *number* match-src-ip-addr  
*ip\_address\_range***

Matches supplied value with packet's source IP address field.

---

**set filterset name *filterset\_name* rule *number* match-dst-ip-addr  
*ip\_address\_range***

Matches supplied value with packet's destination IP address field.

---

**set filterset name *filterset\_name* rule *number* match-protocol *protocol\_string***

Matches supplied value with packet's protocol field.

---

**set filterset name *filterset\_name* rule *number* match-tos [ *number* |  
*descriptive\_value* ]**

Matches TOS field from numeric value 0-255; or one of the following descriptive values:

- Minimize-Delay (0x10)
- Maximize-Throughput (0x08)
- Maximize-Reliability (0x04)
- Minimize-Cost (0x02)
- Normal-Service (0x00)

---

**set filterset name *filterset\_name* rule *number* match-dscp [ *number* |  
*diffserv\_class\_string* ]**

Matches DiffServ class with supplied numerical value, which can be in decimal (ex: 32) or in Hex (ex: 0x20);

Or match the supplied DiffServ class. This value may be any of the BE, EF, AFxx or CSx classes. A full list is:

```
{ "CS0", 0x00 }
{ "CS1", 0x08 }
{ "CS2", 0x10 }
{ "CS3", 0x18 }
{ "CS4", 0x20 }
{ "CS5", 0x28 }
{ "CS6", 0x30 }
{ "CS7", 0x38 }
{ "BE", 0x00 }
{ "AF11", 0x0a }
{ "AF12", 0x0c }
{ "AF13", 0x0e }
{ "AF21", 0x12 }
{ "AF22", 0x14 }
{ "AF23", 0x16 }
{ "AF31", 0x1a }
{ "AF32", 0x1c }
{ "AF33", 0x1e }
{ "AF41", 0x22 }
{ "AF42", 0x24 }
{ "AF43", 0x26 }
{ "EF", 0x2e }
```

---

**set filterset name *filterset\_name* rule *number* match-src-port *number* [ *number* ]**

Matches TCP|UDP source port field or port range.

---

**set filterset name *filterset\_name* rule *number* match-dst-port *number* [ *number* ]**

Matches TCP|UDP destination port field or port range.

---

**set filterset name *filterset\_name* rule *number* match-tcp-flags *tcp\_flag\_string***

Matches TCP flags in a packet. The flag string is comma-delimited.

---

**set filterset name *filterset\_name* rule *number* match-packet-length *number* [ *number* ]**

Matches packet length against value or range.

---

**set filterset name *filterset\_name* rule *number* action forward [ pass | drop | reject ]**

Executes the named filter set's default action: **pass**, **drop**, or **reject**.

---

**set filterset name *filterset\_name* rule *number* match-qos-marker-enable [ off | on ]**

Turns the function of tagging the packet according to the queue marker name on or off. Default is **off**.

---

---

**set filterset name *filterset\_name* rule *number* action set-qos-marker *qos\_marker\_string***

Tags the packet according to the queue marker name. See [“Queue Commands” on page 129](#).

---

**set filterset name *filterset\_name* rule *number* action set-tos *number***

Sets the packet TOD field to the supplied value.

---

**set filterset name *filterset\_name* rule *number* action set-dscp [ *number* | *diffserv\_class\_string* ]**

Sets the DSCP field to the supplied value.

---

**set filterset name *filterset\_name* rule *number* action set-eth-p-bits *number***

Sets VLAN priority bits to the supplied value.

---

**set filterset *filterset\_name* rule *number* action do-filterset *name***

Executes the supplied filter set.

### Default Actions

If a packet passes through all of a filter's rules without a match, then the filter set's default actions come into play. These behave the same way that rule actions behave.

---

**set filterset name *filterset\_name* default-action set-qos-marker *qos\_marker\_string***

Tags the packet according to the queue marker name.

---

**set filterset name *filterset\_name* default-action set-tos *number***

Sets the packet TOS field to the supplied value.

---

**set filterset name *filterset\_name* default-action set-dscp [ *number* | *diffserv\_class\_string* ]**

Sets the DSCP field to the supplied value.

---

**set filterset name *filterset\_name* default-action set-eth-p-bits *number***

Sets VLAN priority bits to the supplied value.

---

**set filterset name *filterset\_name* default-action do-filterset *name***

Executes the supplied filter set.

---

**set filterset name *filterset\_name* default-action forward [ pass | drop | reject ]**

Executes the named filter set's default action: **pass**, **drop**, or **reject**.



## Global Filter Set (“IPv6 Firewall”) Commands

Global filter sets exist at the root level of the hierarchy, outside the umbrella of both the “ip” and “ip6” subtrees, since they pertain to both.

Global filter set rules allow for the specification of these match attributes:

- ◆ IP Protocol
- ◆ Source and/or destination port:
  - UDP
  - TCP
- ◆ TCP flags, for rules that specify TCP traffic
- ◆ ICMP type, for IP-protocol types 1 (ICMP) and 58 (IPv6-ICMP)
- ◆ LAN-side device/range:
  - By MAC address (or current IPv4/6 address, host name, equivalently)
  - IPv4 address, range, or subnet
  - IPv6 address or subnet
- ◆ WAN-side range:
  - IPv4 address, range, or subnet
  - IPv6 address or subnet
- ◆ Ingress and egress interface, by link-oid (such as “LAN”)

---

**set gfs name *filterset\_name* enable [ on | off ]**

Dynamically enables or disables the specified filter set rule.

---

**set gfs name *filterset\_name* default-action value [ pass | drop ]**

Executes the named filter set's default action: **pass** or **drop**.

---

**set gfs name *filterset\_name* rule *number* enable [ on | off ]**

Dynamically enables or disables the specified filter set rule.

---

**set gfs name *filterset\_name* rule *number* active [ on | off ]**

Activates or deactivates the specified filter set rule.

---

**set gfs name *filterset\_name* rule *number* type [ either | ipv4 | ipv6 ]**

Specifies whether the named filter set rule applies to IPv4, IPv6, or both (either).

---

**set gfs name *filterset\_name* rule *number* action value [ pass | drop | accept ]**

Executes the named filter set's action: **pass**, **drop**, or **accept**.

---

**set gfs name *filterset\_name* rule *number* order *number***

Determines order of execution of filter set rules (1 before 2, etc). If **order** is unspecified, the value of **order** is set to 1 more than the last order in the filter set. If **order** is set to an already existing order value, order values of other rules are incremented automatically.

---

**set gfs name *filterset\_name* rule *number* match *number* category [ src-ip-addr | dst-ip-addr | ip-proto | src-port | dst-port | tcp-flags | src-host-mac | dst-host-mac | in-link-oid**

---

## | out-link-oid | icmp-type ]

Matches on the following categories:

---

<b>src-ip-addr</b>	(ip[4 6] address or subnet spec (type ip4 or ip6 only))
<b>dst-ip-addr</b>	(ip[4 6] address or subnet spec (type ip4 or ip6 only))
<b>ip-proto</b>	(0-255 or iana-defined string equivalents)
<b>src-port</b>	(1-65535[:1-65535], only if <b>ip-proto</b> == TCP or UDP)
<b>dst-port</b>	(1-65535[:1-65535], only if <b>ip-proto</b> == TCP or UDP)
<b>tcp-flags</b>	(only if <b>ip-proto</b> == TCP)
<b>icmp-type</b>	(only if <b>ip-proto</b> == ICMP or IPv6 ICMP)
<b>src-host-mac</b>	(MAC address of src)
<b>dst-host-mac</b>	(MAC address of dest)
<b>in-link-oid</b>	(oid of ingress link oid)
<b>out-link-oid</b>	(oid of egress link oid)

---

## set gfs name *filterset\_name* rule *number* match *number* value [ *value* (category-specific) ]



### NOTE:

A rule cannot contain data that specifies both IPv6 and IPv4 at the same time, and thus be applicable to neither **iptables** nor **ip6tables**; however, a rule can be IP-version agnostic, in which case it will be applied to both **iptables** and **ip6tables**, given the proper conditions. For instance, if a LAN-side device has both an IPv4 address and a routable IPv6 address, then one can specify a rule for this device by referring to its MAC address, and if no other match attributes of the rule preclude its use in both tables, the rule will be applied to both **iptables** and **ip6tables** (given the assumption that the LAN Host Discovery database contains both addresses).

---

## Queue Commands

Queue configuration typically requires a classification component to set a QoS marker to a packet and a queueing component to schedule the marked packets to the link. This is accomplished using filter sets ([“Filter Set Commands” on page 124](#)).

The basic queue's size and length are controls for how many packets and total bytes can be enqueued before it is considered to be full. Once it is full, any attempts to enqueue another packet will result in a “tail-drop.”

Both constraints are simultaneously used, such that the queue is full when either packet count *or* byte count exceeds the limit. This allows flexibility in obtaining a balance, where a large number of small packets, but only a small number of large packets can be enqueued.

If there are no tail-drops – that is, the queue is not blocked from sending and doesn't over-fill and dump packets – then these queue size/bytes parameters do not affect anything. Their only function is to adjust the threshold at which the queue is considered full, which dictates when tail-drops will occur. So if there are no tail-drops, then increasing the queue length will have no effect. Increasing the queue length has no effect unless there are tail-drops.

The maximum size/bytes of a queue balances how much burstiness can be buffered versus having a queue that is simply too long.

*Burstiness smoothing* requires queueing up the buffers. For example, if the upstream line rate is 1 mbps, but the traffic source sends 100 mbps bursts for 10 ms every second (which coincidentally averages 1 mbps) then

the router will have to buffer enough (about a full second worth of traffic) so that the burst of traffic doesn't get tail-dropped when it arrives and is enqueued at the same time in the same burst.

On the other hand, it is undesirable to buffer too much data in the queue(s) since the packets may be stale by the time they are sent. It may be desirable to drop the traffic sufficiently that there are queuing disciplines such as Random Early Discard (RED) that do not drop packets from the tail of the queue. Instead, RED drops packets towards the front of the queue, so that the congestion is noticed more quickly in order for the sender to scale back bandwidth usage to avoid drops.

The following types of queue "building blocks" are supported:

- ◆ **basic** queue
- ◆ **ingress** queue
- ◆ **priority** queue
- ◆ **wfq** (weighted fair queue)

Basic queues have three different packet dropping options:

- ◆ byte | packet fifo (**bpfifo**)
- ◆ random early discard (**red**)
- ◆ stochastic fairness queuing (**sfq**)

---

**set queue name *queue\_name* type [ basic | ingress | priority | wfq ]**

Sets the type of queue.

---

**set queue name *queue\_name* options [ off | red | sfq ]**

Sets the queue packet dropping options.

---

**set queue name *queue\_name* size [ 1... 64 ]**

Sets the maximum number of packets that can be enqueued.

---

**set queue name *queue\_name* bytes [ 2048... 131072 ]**

Sets the maximum total number of bytes that can be enqueued.

---

**set queue name *queue\_name* perturb [ 0... 100 ]**

Sets the interval in seconds for queue algorithm perturbation when queue option is **sfq**.

---

**set queue name *queue\_name* police-rate [ 0... 10000000 ]**

Sets the rate in milliseconds that is used for policing traffic when the queue type is **ingress**.

---

**set queue name *queue\_name* police-burst [ 0... 10000000 ]**

Sets the burst rate in milliseconds that is used for policing traffic when the queue type is **ingress**.

---

**set queue name *queue\_name* bw-sharing [ on | off ]**

Enables or disables bandwidth sharing, when the queue type is either **priority** or **wfq**.

---

---

### **set queue name ip-*proto-mode* [ *bps* | *relative* ]**

Sets the mode of the weighted fair queue. The **bps** keyword indicates that weights are defined as bits-per-second. The **relative** keyword indicates that weights are defined as a proportion of the sum of the weights of all inputs to the **wfq**.

---

### **set queue name *queue\_name* entry *number* input *queue\_name***

Sets the input to a priority or weighted fair queue.

---

### **set queue name *queue\_name* entry *number* marker *queue\_marker***

Sets the marker with which packets must be marked to be directed to this queue entry's input queue when the type is **priority** or **wfq**.

---

### **set queue name *queue\_name* entry *number* priority [ 0... 255 ]**

Sets the priority level of this queue. A lower value indicates a higher priority. All entries of equal priority will be subject to a round robin algorithm.

- ◆ For (strict) **priority** queue, the higher priority gets link resource first.
- ◆ For **wfq** queue, each entry gets reserved bandwidth according to its weight. If different priority is given, any excess bandwidth is offered to higher priority entry first; otherwise any excess bandwidth is distributed to the weights ratio.

---

### **set queue name *queue\_name* entry *number* weight [ 0... 100 ]**

Sets the weight level of this weighted fair queue. Weight units are dependent on **bps-mode** setting.

- ◆ If **bps-mode** is set to **bps**, then setting the weight to 0 will allocate the remaining available bandwidth to the queue entry.
- ◆ If no priority specified, excess bandwidth will be distributed proportionately to the weight ratio.

---

### **set queue name *queue\_name* entry *number* peak [ 0... 100,000,000 ]**

Sets the peak level of this weighted fair queue. The **peak** parameter is a number from 0 through 100,000,000 in bits/second. It must be at least 50,000 for best effect. It is the peak data rate allowed on the queue entry, and usually supports bandwidth sharing, that is, if other queues are not busy and there is spare bandwidth, then a busy queue is allowed to go up to the peak rate.

---

### **set queue name *queue\_name* default-entry *queue\_name***

Indicates the input queue used if there is no match between the packet queue marker and the configured markers in any of the queue's inputs when the queue type is **priority** or **wfq**.

## IP Gateway Commands

---

### set ip gateway enable [ on | off ]

Specifies the **conn** of the gateway. Normally, this would be the WAN connection. Specifies whether the NVG599 should send packets to a default gateway if it does not know how to reach the destination host.

### set ip gateway conn-oid *value*

Sets the default gateway to point to an associated link specified by the **conn-oid** value.

### set ip gateway address *ip\_address*

Specifies the IP address of a host on a local or remote network in standard dotted-quad format.

## IPv6 Commands

---

### set ip6 enable [ on | off ]

Enables/disables IPv6 globally. The default is **off**. When enabled, the following default configuration is created:

```
set ip6 enable on
set ip6 conn name "WANv6" enable on
set ip6 conn name "WANv6" type rd
set ip6 conn name "WANv6" mtu 1472
set ip6 conn name "WANv6" side wan
set ip6 conn name "WANv6" mcast-forwarding off
set ip6 conn name "WANv6" icmp-echo-drop on
set ip6 conn name "WANv6" traffic-class-clear on
set ip6 conn name "WANv6" 6rd-tunnel type cpe
set ip6 conn name "WANv6" 6rd-tunnel ipv4-conn "WAN"
set ip6 conn name "WANv6" 6rd-tunnel use-dhcp-values off
set ip6 conn name "WANv6" 6rd-tunnel prefix "::"
set ip6 conn name "WANv6" 6rd-tunnel prefix-length 1
set ip6 conn name "WANv6" 6rd-tunnel ipv4-common-bits 0
set ip6 conn name "WANv6" 6rd-tunnel relay-ipv4-addr "0.0.0.0"
set ip6 conn name "WANv6" 6rd-tunnel ipv4-tx-tos-mode off
set ip6 conn name "WANv6" 6rd-tunnel force-tx-to-br on
set ip6 conn name "WANv6" 6rd-tunnel anti-spoof-enable on
set ip6 conn name "WANv6" 6rd-tunnel tx-df-bit-set on
set ip6 conn name "LANv6" enable off
set ip6 gateway enable on
set ip6 gateway conn "WANv6"
set ip6 gateway address "::"
set ip6 dhcp-server enable on
set ip6 dhcp-server information-only off
set ip6 dhcp-server preference 255
set ip6 dhcp-server authoritative on
set ip6 dhcp-server rapid-commit on
set ip6 dhcp-server unicast off
set ip6 dhcp-server leasequery off
set ip6 dhcp-server pd-enable on
set ip6 dhcp-server default-lease-time 2592000
set ip6 dhcp-server preferred-lifetime 604800
set ip6 dhcp-server T1 302400
set ip6 dhcp-server T2 483840
```

---

```
set ip6 dhcp-server info-refresh-time 86400
set ip6 dns primary-address ""
set ip6 dns secondary-address ""
```

#### Default IPv6 security configuration values:

```
set security spi ip6 src-mcast-drop off
set security spi ip6 invalid-mcast-scope-drop on
set security spi ip6 forbidden-addr-drop on
set security spi ip6 deprecated-ext-hdr-drop on
set security spi ip6 src-addr-from-lan-unassigned-drop on
set security spi ip6 lan-assigned-src-addr-from-wan-drop on
set security spi ip6 ula-drop on
set security spi ip6 ignore-dns-from-wan on
set security spi ip6 ignore-dhcp-from-wan on
set security spi ip6 esp-hdr-drop on
set security spi ip6 ah-hdr-drop on
set security spi ip6 allow-inbound off
set security spi ip4 invalid-addr-drop on
set security spi ip4 private-addr-drop off
set security spi flood-limit enable off
set security ip6 firewall-level low
set security ip6 enable on
```

### ip6 gateway conn

---

#### set ip6 gateway enable [ on | off ]

Enables or disables IPv6 default gateway.

---

#### set ip6 gateway conn *value*

Sets the default gateway to point to an associated link specified by the **conn-oid** value. Normally, this would be the WAN connection.

---

#### set ip6 gateway address *ipv6\_address*

Specifies the IPv6 address of a host on a local or remote network in standard IPv6 format.

### ip6 conn

---

#### set ip6 conn name *name* enable [ on | off ]

Enables/disables the IPv6 connection named *name*.

---

#### set ip6 conn name *name* type [ static | autoconf | rd | dp | aiccu ]

Type of connection. See below for connection types.

---

#### set ip6 conn name *name* mtu *octets*

Specified MTU of connection.

---

#### set ip6 conn name *name* side [ lan | wan ]

Specified whether the connection is LAN side or WAN side.

---

**set ip6 conn name *name* mcast-fwding [ off | on ]**

Turns IPv6 multicast forwarding for this connection off or on. The default is **off**. (not yet implemented)

---

**set ip6 conn name *name* old-prefix-purge-timer**

The time in seconds for which old, invalid prefixes are advertised with a lifetime of zero. The intent is to “flush out” global prefixes on attached IPv6 hosts that suddenly become invalid.

**Static Connections**

**ip6 conn (type = static):** Statically configured IPv6 connection.

---

**set ip6 conn name *name* static link-oid *link\_name***

Sets the connection named *name* to point to an associated link specified by the **link-oid** *link\_name*.

---

**set ip6 conn name *name* static ipaddr *ipv6\_address***

Specifies a static IPv6 address.

---

**set ip6 conn name *name* static prefix-length *value***

Specifies the prefix length of the connection's static IPv6 address. Default is **64**.

**6rd Connections**

**ip6 conn (type = rd, side = wan):** This WAN connection type is a 6rd tunnel over an IPv4 conn in accordance with RFC 5569.

---

**set ip6 conn name *name* 6rd-tunnel type [ cpe | gateway ]**

The 6rd connection can operate in “cpe” or “gateway” mode as configured by the **type** parameter. “cpe” mode is used when operating as a CPE; “gateway” mode is used when operating as a “6rd relay,” as per RFC 5569.

---

**set ip6 conn name *name* 6rd-tunnel ipv4-conn-oid *ipv4\_name***

Sets the 6rd connection named *name* to tunnel over an associated IPv4 connection named *ipv4\_name*.

---

**set ip6 conn name *name* 6rd-tunnel use-dhcp-values [ off | on ]**

If this parameter is on, 6rd-provisioned parameters are obtained via the underlying DHCPv4 client associated with the IPv4 connection named *ipv4\_name*. See the Internet Engineering Task Force document, “draft-ietf-softwire-ipv6-6rd-10” for DHCP format description.

**ip6 conn (type = rd, 6rd-tunnel use-dhcp-values = off).**

---

**set ip6 conn name *name* 6rd-tunnel prefix *IPv6\_address***

6rd domain prefix.

---

**set ip6 conn name *name* 6rd-tunnel prefix-length *value* [ 1 - 63 ]**

6rd domain prefix length.

---

---

---

**set ip6 conn name *name* 6rd-tunnel ipv4-common-bits *value* [ 0 - 31 ]**

The number of bits common to all IPv4 addresses within the 6rd domain. The top-most bits of the IPv4 address will be “subtracted” from the 6rd address. If the whole 32-bit IPv4 address is contained in the 6rd IPv6 address, this value is set to zero. Default is 0, meaning all 42 bits of the IPv4 address are embedded in the 6rd prefix.

---

**set ip6 conn name *name* 6rd-tunnel relay-ipv4-addr *IPv4\_address***

The IPv4 anycast address of the 6rd border gateway.

---

**set ip6 conn name *name* 6rd-tunnel ipv4-tx-tos-mode [ off | use-ipv6 ]**

The **off** parameter sets the TOS field in the IPv4 header to zero for transmitted 6rd packets. The keyword **use-ipv6** sets the the TOS field in the IPv4 headerto the DS field of the 6rd-encapsulated IPv6 packet.

---

**set ip6 conn name *name* 6rd-tunnel ipv4-tx-to-br [ off | on ]**

If the **off** parameter is used, each packet set to a destination IPv6 address within the originating 6rd domain is sent directly to the 6rd endpoint. If the keyword **on** is used, all packets are transmitted to the 6rd border gateway.

### AICCU (SixXS tunnel broker) Connections

**ip6 conn (type = aiccu, side = wan).** This connection type enables an IPv6 connection to the IPv6 Internet over an IPv4/NAT/UDP tunnel to a tunnel endpoint administered by tunnel broker SIXXS ([www.sixxs.net](http://www.sixxs.net)).

You set up an account with SIXXS, and subsequently get assigned a tunnel and a subnet (usually a /48 subnet).

---

**set ip6 conn name *name* aiccu username *username***

Sets the connection’s SIXXS user name.

---

**set ip6 conn name *name* aiccu password *password***

Sets the connection’s SIXXS password.

### Delegated Prefix Connections

**ip6 conn (type = dp, side = lan).** A connection of type “delegated prefix” obtains its global prefix information from one or more prefixes from another IPv6 connection (typically a WAN), if available. For a delegated prefix connection to become fully operational, its underlying link must be up *and* the IPv6 connection that delegates the prefix must have created one or more prefixes from which to draw the delegated prefix connection’s global prefix.

---

**set ip6 conn name *name* dp link-oid *link\_name***

Sets the connection to obtain its prefix from the specified link.

---

**set ip6 conn name *name* dp conn-oid *ipv6\_conn\_name***

Sets the delegated prefix connection named *name* to obtain its prefix from IPv6 connection named *ipv6\_conn\_name*.



---

**set ip6 conn name *name* dp subnet-length *value* [ 0 - 16 ]**

The length of the subnet portion of the delegated prefix. Default is 0.

---

**set ip6 conn name *name* dp subnet-id *value* [ 0 - 65535 ]**

If a subnet length is specified, the value that would occupy the of the subnet portion of the connection's IPv6 prefix. Default is 0.

---

**set ip6 conn name *name* dp stay-up [ off | on ]**

If the delegated prefix parameter **stay-up** is set to **on**, the global prefix assigned from the connection delegating the prefix remains active in the event that the connection delegating the prefix goes down, and the prefix becomes invalid. This enables local LAN-side hosts to continue to use the global prefix uninterrupted. If parameter **stay-up** is set to **off**, the connection's delegated prefix becomes invalid when the connection named **ip6v6-conn-name** delegating the prefix goes down.

### Router Advertisement and DHCPv6 Server

**ip6 conn (side = lan).** Router advertisements and the DHCPv6 server are available on LAN-side connections as the means to provide clients with stateful or stateless IPv6 prefixes and addresses, as well as addition client parameters such as MTU size and IPv6-addressable DNS servers.

---

**set ip6 conn name *name* radv enable [ off | on ]**

The **on** parameter sets router advertisement to enabled for this connection.

---

**set ip6 conn name *name* radv min-rtr-adv-interval *seconds* [ 3 - 1350 ]**

The minimum time allowed between sending unsolicited multicast router advertisements from the link, in seconds.

---

**set ip6 conn name *name* radv max-rtr-adv-interval *seconds* [ 4 - 1800 ]**

The maximum time allowed between sending unsolicited multicast router advertisements from the interface, in seconds.

---

**set ip6 conn name *name* dhcp-server enable [ off | on ]**

The **on** parameter sets the DHCPv6 server to enabled for this connection.

---

**set ip6 conn name *name* dhcp-server addr-count *value* [ 0 - 256 ]**

The number of IPv6 addresses available to serve to DHCPv6 stateful clients. If the **addr-count** parameter is set to zero, the DHCPv6 server operates in "stateless" mode.

---

**set ip6 conn name *name* dhcp-server start-addr-offset *value* [ 0 - 65536 ]**

If the **addr-count** parameter is greater than zero, the start address is an offset from the base address of the prefix that is assigned to the LAN connection.

---

**set ip6 conn name *name* dhcp-server lease-time *seconds* [ 180 - 8553600 ]**

DHCPv6 lease time.

---

---

---

**set ip6 conn name name dhcp-server dns-server optional IPv6 address**

IPv6 address of advertised DNS server (optional).

---

**IPv6 DHCP Server**

---

**set ip6 dhcp-server enable [ on | off ]**

Globally enables or disables DHCPv6 servers on all IPv6 LAN connections. The default is **on**.

---

**set ip6 dhcp-server information-only [ off | on ]**

The **on** parameter sets DHCPv6 servers on all IPv6 LAN connections to operate in stateless “information-only” mode. The default is **off**.

---

**set ip6 dhcp-server preference 255**

Sets the preference option, as defined in RFC1315, sec. 22.8. The preference option in the server’s Advertise message may assist a DHCPv6 client in selecting from more than one server on the LAN.

---

**set ip6 dhcp-server authoritative [ on | off ]**

If a client requests an IP address on a given network segment that the server knows is not valid for that segment, and **authoritative** is set to **on**, the server will respond with a DHCPNAK message, causing the client to forget its IP address and try to get a new one. If **authoritative** is set to **off**, the server will ignore the client’s request. The default is **on**.

---

**set ip6 dhcp-server rapid-commit [ on | off ]**

Enables or disables the rapid commit option per RFC 3315 Section 22.14. The default is **on**.

---

**set ip6 dhcp-server unicast [ off | on ]**

Enables or disables server unicast option per RFC 3315 Section 22.12. The default is **off**.

---

**set ip6 dhcp-server leasequery [ off | on ]**

Enables or disables DHCPv6 Leasequery option per RFC 5007. The default is **off**.

---

**set ip6 dhcp-server pd-enable [ on | off ]**

Enables or disables prefix delegation globally on all DHCPv6 servers on all IPv6 LAN connections, overriding individual DHCPv6 server settings. The default is **on**.

---

**set ip6 dhcp-server default-lease-time *seconds***

Sets the global DHCPv6 lease time setting in seconds. The default is **2592000** (30 days).

---

**set ip6 dhcp-server preferred-lifetime *seconds***

Sets the global DHCPv6 preferred lifetime of prefixes in seconds, per RFC 3633. The default is **604800** (7 days).

---

### **set ip6 dhcp-server T1 seconds** **set ip6 dhcp-server T2 seconds**

Sets global DHCPv6 T1, T2 values, per RFC 3315 for local NA addresses:

- 
- |           |   |
|-----------|---|
| <b>T1</b> | The time at which the client contacts the server from which the addresses in the IA_NA were obtained to extend the lifetimes of the addresses assigned to the IA_NA; T1 is a time duration relative to the current time expressed in seconds. Defaults to <b>302400</b> (3.5 days). |
| <b>T2</b> | The time at which the client contacts any available server to extend the lifetimes of the addresses assigned to the IA_NA; T2 is a time duration relative to the current time expressed in seconds. Defaults to <b>483840</b> (5.6 days).   |

And also per global DHCPv6 T1, T2 values, per RFC 3633 for PD prefixes:

- 
- |           |  |
|-----------|--|
| <b>T1</b> | The time at which the requesting router should contact the delegating router from which the prefixes in the IA_PD were obtained to extend the lifetimes of the prefixes delegated to the IA_PD; T1 is a time duration relative to the current time expressed in seconds. |
| <b>T2</b> | The time at which the requesting router should contact any available delegating router to extend the lifetimes of the prefixes assigned to the IA_PD; T2 is a time duration relative to the current time expressed in seconds.   |

---

### **set ip6 dhcp-server info-refresh-time seconds**

In seconds, per RFC 4242: The information refresh time option specifies an upper bound for how long a client should wait before refreshing information retrieved from DHCPv6 in stateless mode. The default is **86400** (24 hours).

#### Static Routes

##### **ip6 static-route**

---

### **set ip6 static-route name conn-oid *ipv6\_conn\_name***

Route is directed to IPv6 connection named *ipv6\_conn\_name*.

---

### **set ip6 static-route name nexthop *IPv6\_address***

Next-hop IPv6 address for forwarding. Can be a global or link-local address.

---

### **set ip6 static-route name prefix *IPv6\_prefix***

IPv6 prefix.

---

### **set ip6 static-route name prefix-length *value* [ 1 - 64 ]**

IPv6 prefix-length.

---

### **set ip6 static-route name metric *value* [ 0 - 255 ]**

Metric assigned to route.

---

## IP DNS Commands

---

### **set ip dns domain-name *domain\_name***

Specifies the default domain name for your network. When an application needs to resolve a host name, it appends the default domain name to the host name and asks the DNS server if it has an address for the fully qualified host name.

---

### **set ip dns primary-address *ip\_address***

Specifies the IP address of the primary DNS name server.

---

### **set ip dns secondary-address *ip\_address***

Specifies the IP address of the secondary DNS name server. Enter **0.0.0.0** if your network does not have a secondary DNS name server.

---

### **set ip dns proxy-enable [ on | off ]**

Allows you to disable the default behavior of acting as a DNS proxy. The default is **on**.

## IP IGMP Commands

*Multicasting* is a method for transmitting large amounts of information to many, but not all, computers over an internet. One common use is to distribute real-time voice, video, and data services to the set of computers which have joined a distributed conference. Other uses include updating the address books of mobile computer users in the field, or sending out company newsletters to a distribution list.

Since a router should not be used as a passive forwarding device, NVG599 devices use a protocol for forwarding multicasting: Internet Group Management Protocol (IGMP).

NVG599 devices support IGMP Version 1, Version 2, or Version 3.

*IGMP "Snooping"* is a feature of Ethernet Layer 2 switches that "listens in" on the IGMP conversation between computers and multicast routers. Through this process, it builds a database of locations where the multicast routers reside by noting IGMP general queries used in the querier selection process and by listening to other router protocols.

From the host point of view, the snooping function listens at a port level for an IGMP report. The switch then processes the IGMP report and starts forwarding the relevant multicast stream onto the host's port. When the switch receives an IGMP leave message, it processes the leave message, and if appropriate, stops the multicast stream to that particular port. Basically, customer IGMP messages although processed by the switch are also sent to the multicast routers.

In order for IGMP snooping to function with IGMP Version 3, it must always track the full source filter state of each host on each group, as was previously done with Version 2 only when fast leave support was enabled.

IGMP Version 3 supports source filtering, which is the ability for group memberships to incorporate source address filtering. This ability allows source-specific multicast (SSM). By adding source filtering, a gateway that proxies IGMP can more selectively join the specific multicast group for which there are interested LAN multicast receivers.

These features require no user configuration on the gateway.

You can set the following options:

- ◆ **IGMP Snooping** – Enables the NVG599 to “listen in” to IGMP traffic. The NVG599 discovers multicast group membership for the purpose of restricting multicast transmissions to only those ports which have requested them. This restriction helps to reduce overall network traffic from streaming media and other bandwidth-intensive IP multicast applications.
- ◆ **Robustness** – A way of indicating how sensitive to lost packets the network is. IGMP can recover from robustness minus 1 lost IGMP packet. The default value is 2.
- ◆ **Query Interval** – The amount of time in seconds between IGMP General Query messages sent by the querier gateway. The default query interval is 125 seconds.
- ◆ **Query Response Interval** – The maximum amount of time in tenths of a second that the IGMP gateway waits to receive a response to a General Query message. The default query response interval is 10 seconds and must be less than the query interval.
- ◆ **Unsolicited Report Interval** – The amount of time in seconds between repetitions of a particular computer's initial report of membership in a group. The default unsolicited report interval is 10 seconds.
- ◆ **Querier Version** – Version of the IGMP querier: version 1, version 2, or version 3. If you know you will be communicating with other hosts that are limited to v1 or v2, for backward compatibility, select accordingly; otherwise, allow the default v3.



**NOTE:**

IGMP querier version is relevant only if the gateway is configured for IGMP forwarding. If any IGMP v1 routers are present on the subnet, the querier must use IGMP v1. The use of IGMP v1 must be administratively configured, since there is no reliable way of dynamically determining whether IGMP v1 routers are present on a network. IGMP forwarding is enabled per the IP profile and the WAN connection profile.

- ◆ **Last Member Query Interval** – The amount of time in tenths of a second that the IGMP gateway waits to receive a response to a Group-Specific Query message. The last member query interval is also the amount of time in seconds between successive Group-Specific Query messages. The default last member query interval is 1 second (10 deci-seconds).
- ◆ **Last Member Query Count** – The number of Group-Specific Query messages sent before the gateway assumes that there are no members of the host group being queried on this interface. The default last member query count is 2.
- ◆ **Fast Leave** – Set to **off** by default, fast leave enables a non-standard expedited leave mechanism. The querier keeps track of which client is requesting which channel by IP address. When a leave message is received, the querier can check its internal table to see if there are any more clients on this group. If there are none, it immediately sends an IGMP leave message to the upstream querier.
- ◆ **Log Enable** – If set to on, all IGMP messages on both the LAN and the WAN will be logged.
- ◆ **Wireless Multicast to Unicast conversion** – Only available if IGMP snooping is enabled. If set to **on**, the gateway replaces the multicast MAC address with the physical MAC address of the wireless client. If there is more than one wireless client interested in the same multicast group, the gateway will revert to multicasting the stream immediately. When one or more wireless clients leave a group, and the gateway determines that only a single wireless client is interested in the stream, it will once again unicast the stream.

---

### set ip igmp querier-version [ 1 | 2 | 3 ]

Sets the IGMP querier version: version 1, version 2, or version 3. If you know you will be communicating with other hosts that are limited to v1, for backward compatibility, select 1; otherwise, allow the default 3.

---

### set ip igmp robustness *value*

Sets IGMP robustness range: 2 – 255. The default is 2.

---

### set ip igmp query-interval *value*

Sets the query-interval range: 10 seconds – 600 seconds. The default is 125 seconds.

---

---

### **set ip igmp query-response-interval *value***

Sets the query-response interval range in deci-seconds (tenths of a second): 5 – 255. The default is 100 deci-seconds.

---

### **set ip igmp unsolicited-report-interval *value***

Sets the unsolicited report interval: the amount of time in seconds between repetitions of a particular computer's initial report of membership in a group. The default is 10 seconds.

---

### **set ip igmp fast-leave [ off | on ]**

Sets fast leave **on** or **off**. Set to **on** by default, fast leave enables a non-standard expedited leave mechanism. The querier keeps track of which client is requesting which channel by IP address. When a leave message is received, the querier can check its internal table to see if there are any more clients on this group. If there are none, it immediately sends an IGMP leave message to the upstream querier.

---

### **set ip igmp max-group-memberships *value***

Sets the maximum number of IGMP group memberships. Default is **20**.

---

### **set ip igmp fwd-admin-groups [ off | on ]**

Turns Admin group forwarding off or on. Default is **off**.

---

### **set ip igmp last-member-interval *value***

Sets the last member query interval: the amount of time in tenths of a second that the IGMP gateway waits to receive a response to a Group-Specific Query message. The last member query interval is also the amount of time in seconds between successive Group-Specific Query messages. The default is 1 second (10 deci-seconds).

---

### **set ip igmp last-member-count *value***

Sets the last member query count: the number of Group-Specific Query messages sent before the gateway assumes that there are no members of the host group being queried on this interface. The default is 2.

---

### **set ip igmp default-fwd-allow [ on | off ]**

Turns default forwarding on or off. The default is **on**.

---

### **set ip igmp snoop-entry-time *seconds***

The **snoop-entry-time** value is the amount of time an entry will remain in the snooping table (in seconds) after being added. An entry is added when a join is seen from a multicast client. Any new joins (triggered by upstream queries) will reset the timeout back to the value of **seconds**. If no additional joins are seen, the entry will expire after the value of **seconds**. Default is **130**.

---

### **set ip igmp snooping-unreg-mode [ block | flood ]**

The **snooping-unreg-mode** value can be set to **block** or **flood**. This value indicates what should happen to unregistered multicast traffic – traffic that hasn't been subscribed to by any clients. If set to **flood**, the traffic will be sent to all LAN ports. If set to **block**, the traffic will not be sent to any LAN ports; it will be dropped. Default is **block**.

## NTP Commands

---

### **set ip ntp enable [ on | off ]**

Enables or disables acquiring the time of day from an NTP (Network Time Protocol) server.

---

### **set ip ntp server-address *server\_address* set ip ntp alt-server-address *alt\_server\_address***

Specifies the NTP server(s) to use for time updates. The NTP **server-address** and **alt-server-address** values can be entered as DNS names as well as IP addresses.

---

### **set ip ntp update-period *minutes***

Specifies how often, in minutes, the gateway should update the clock. Default is **1440**.

---

## Application Layer Gateway (ALG) Commands

These commands allow you to enable or disable the router's support for a variety of application layer gateways (ALGs). An application layer gateway (ALG) is a NAT component that helps certain application sessions to pass cleanly through NAT. Each ALG has a slightly different function based on the particular application's protocol-specific requirements.

An internal client first establishes a connection with the ALG. The ALG determines if the connection should be allowed or not and then establishes a connection with the destination computer. All communications go through two connections – client to ALG and ALG to destination. The ALG monitors all traffic against its rules before deciding whether or not to forward it. Because the ALG is the only address seen by the public Internet, the internal network is concealed. In some situations, it may be desirable to disable some of the ALGs.

---

### **set ip alg esp-enable [ on | off ]**

Turns the ESP (Encapsulating Security Payload) ALG for file transfers **on** or **off**. Default is **on**.

---

### **set ip alg esp-setup-timeout *value***

Specifies the timeout value for the ESP ALG setup. Default is **180**.

---

### **set ip alg esp-stream-timeout *value***

Specifies the timeout value for the ESP ALG streaming. Default is **300**.

---

### **set ip alg ftp-enable [ on | off ]**

Turns the FTP (File Transfer Protocol) ALG for file transfers **on** or **off**. Default is **on**.

---

### **set ip alg h323-enable [ on | off ]**

Turns the H323 ALG for audio, video, and data communications across IP-based networks **on** or **off**. Default is **on**.

---

### **set ip alg pptp-enable [ on | off ]**

Turns the PPTP (Point-to-Point Transfer Protocol) ALG for authentication **on** or **off**. Default is **on**.

---

---

---

### **set ip alg sip-enable [ on | off ]**

Turns the SIP (Session Initiation Protocol) ALG for voice communication initiation **on** or **off**. Default is **on**.

---

### **set ip alg tftp-enable [ on | off ]**

Turns the TFTP (Trivial File Transfer Protocol) ALG for simple file transfers and firmware updates **on** or **off**. Default is **on**.

## **Dynamic DNS Commands**

---

### **set ip dynamic-dns enable [ off | on ]**

Enables or disables dynamic DNS. Dynamic DNS support allows you to use the free services of [www.dyndns.org](http://www.dyndns.org). Dynamic DNS automatically directs any public Internet request for your computer's name to your current dynamically-assigned IP address. This allows you to get to the IP address assigned to your gateway, even though your actual IP address may change as a result of a PPPoE connection to the Internet.

---

```
set ip dynamic-dns service-type [ dyndns ]  
set ip dynamic-dns username myusername  
set ip dynamic-dns password mypassword  
set ip dynamic-dns hostname myhostname  
set ip dynamic-dns retries [ 1 - 64 ]
```

Enables or disables dynamic DNS services. The default is **off**. If you specify **dyndns.org**, you must supply your host name, user name for the service, and password. Number of retries defaults to 5.

## **Default Server Settings**

---

### **set ip wan-allocation mode [ normal | defaultserver ]**

Sets the WAN mode to direct your NVG599 to forward all externally initiated IP traffic (TCP and UDP protocols only) to a default host on the LAN, otherwise this feature is disabled. Default is **normal**.

## **Link Commands**

The **link** commands represent physical connections. Currently, port-based VLAN support is provided at this level. Your NVG599 device is capable of adding and stripping 802.1Q tags to and from frames before transmission on its LAN interfaces. See also "[Filter Set Commands](#)" on page 124 and "[Queue Commands](#)" on page 129 for more information.

---

### **set link name *name* type [ ethernet | ppp ]**

Specifies whether the **type** of the link named ***name*** is **ethernet** or **ppp**.

---

### **set link name *name* mtu-override [ 0 - 1500 ]**

Specifies whether the maximum transmission unit value should be set to other than the standard 1500. A setting of **0** (zero) turns off override.

---

### **set link name *name* igmp-snooping [ off | on ]**

Turns **igmp-snooping** **off** or **on** on the link named ***name***.



---

**set link name *name* port-vlan ports [ lan-1... 4 | hpna | ssid-1...4 | ptm | vc-1 | vc-2 ]**

Specifies a port-based VLAN on the selected ports on the link named *name*.

---

**set link name *name* port-vlan priority [ 0 - 7 ]**

Specifies the 802.1p priority bit. If you set this to a value greater than 0, all packets of this VLAN with unmarked priority bits (pbits) will be re-marked to this priority.

---

**set link name *name* tagged-vlan name *integer* ports [ lan-1... 4 | hpna | ssid-1...4 | ptm | vc-1 | vc-2 ]**

Specifies a tagged VLAN on the selected port on the link named *name*. Default is **ptm**.

---

**set link name *name* tagged-vlan name *integer* vid *vlan\_id***

Specifies a VLAN ID (VID) on the selected link named *name*. Default is **0**.

---

**set link name *name* tagged-vlan name *integer* priority [ 0 - 7 ]**

Specifies the 802.1p priority bit. If you set this to a value greater than 0, all packets of this VLAN with unmarked priority bits (pbits) will be re-marked to this priority.

---

**set link name *name* supplicant type [ none | eap-tls ]**

Specifies whether the EAP TLS supplicant is enabled on the link named *name*. Default is **eap-tls**.

---

**set link name *name* supplicant priority [ 0 - 7 ]**

Sets the supplicant priority on the link named *name* when supplicant type is **eap-tls**. Default is **0**.

---

**set link name *name* ppp sub-link *link\_name***

Specifies a name *link\_name* for this secondary link when one is required.

---

**set link name *name* ppp auth-type [ on | off ]**

Enables or disables PPP login authorization.

---

**set link name *name* ppp username *uname***

Specifies a user name *uname* for authentication on the specified link when **ppp auth-type** is set to **on**.

---

**set link name *name* ppp password *pwd***

Specifies a password *pwd* for authentication on the specified link when **ppp auth-type** is set to **on**.

---

**set link name *name* ppp magic-number [ on | off ]**

Enables or disables LCP magic number negotiation.

---

---

---

**set link name *name* ppp protocol-compression [ off | on ]**

Specifies whether you want the NVG599 to compress the PPP Protocol field when it transmits datagrams over the PPP link.

---

**set link name *name* ppp max-failures *integer***

Specifies the maximum number of Configure-NAK messages the PPP module can send without having sent a Configure-ACK message. The *integer* argument can be any number between 1 and 20.

---

**set link name *name* ppp max-configures *integer***

Specifies the maximum number of unacknowledged configuration requests that your NVG599 will send. The *integer* argument can be any number between 1 and 20.

---

**set link name *name* ppp max-terminates *integer***

Specifies the maximum number of unacknowledged termination requests that your NVG599 will send before terminating the PPP link. The *integer* argument can be any number between 1 and 10.

---

**set link name *name* ppp restart-timer *integer***

Specifies the number of seconds the NVG599 should wait before retransmitting a configuration or termination request. The *integer* argument can be any number between 1 and 30.

---

**set link name *name* ppp connection-type [ instant-on | always-on ]**

Specifies whether a PPP connection is maintained by the NVG599 device when it is unused for extended periods. If you specify **always-on**, the NVG599 never shuts down the PPP link. If you specify **instant-on**, the NVG599 shuts down the PPP link after the number of seconds specified in the timeout setting (below) if no traffic is moving over the circuit.

---

**set link name *name* ppp echo-request [ on | off ]**

Specifies whether you want your NVG599 to send LCP echo requests. You should turn off LCP echoing if you do not want the NVG599 to drop a PPP link to a nonresponsive peer.

---

**set link name *name* ppp echo-failures *integer***

Specifies the maximum number of lost echoes the NVG599 should tolerate before bringing down the PPP connection. The *integer* argument can be any number from between 1 and 20.

---

**set link name *name* ppp echo-interval *integer***

Specifies the number of seconds the NVG599 should wait before sending another echo from an LCP echo request. The *integer* argument can be any number from between 5 and 300 (seconds).

---

**set link name *name* ppp mru *integer***

Specifies the maximum receive unit (MRU) for the PPP interface. The *integer* argument can be any number between 128 and 1492 for PPPoE; 1500 otherwise.

---

### **set link name *name* ppp peer-dns [ on | off ]**

Controls whether the NVG599 accepts name server addresses from the peer.

- ◆ The default is **on**, which means the NVG599 expects to get name server addresses when the PPP link comes up. This especially applies when the primary WAN connection is PPP.
- ◆ However, there are some unusual situations where the PPP connection is *not* the primary WAN, for example when the connection is used only for management. In that situation it may be desirable to *not* pick up more name server addresses. You can do that by setting the parameter to **off**.



**NOTE:**

This is an expert-mode setting that will rarely be used. The setting should be left on, unless you are an expert user who knows you do not want the NVG599 to acquire any name server addresses from this PPP connection.

---

Specifies an ISP name or a class or quality of service. The service name tells the access concentrator which network service the NVG599 is trying to reach.

---

### **set link name *name* pppoe ac-name *name***

Specifies this particular access concentrator (AC) unit from all others. Some access provider networks may have multiple PPPoE servers, and having the NVG599 indicate an AC name specifies to which one the NVG599 is trying to connect.

## **Management Commands**

All management related items are grouped in this section.

---

### **set management account administrator username *username***

Specifies the **username** for the administrative user. The default is **admin**.

---

### **set management account user username *username***

Specifies the **username** for the non-administrative user. The default is **user**.

---

### **set management cwmp enable [ off | on ]**

Turns **cwmp** (TR-069 CPE WAN Management Protocol) **on** or **off**. TR-069 allows a remote auto-config server (ACS) to provision and manage the NVG599 device. TR-069 protects sensitive data on the NVG599 by not advertising its presence, and by password protection.

---

### **set management cwmp acs-url *acs\_url:port\_number***

### **set management cwmp acs-username *acs\_username***

### **set management cwmp acs-password *acs\_password***

If TR-069 WAN-side management services are enabled, specifies the auto-config server URL and port number. A user name and password must also be supplied, if TR-069 is enabled.

---

The auto-config server is specified by URL and port number. The format for the ACS URL is as follows:

`http://some_url.com:port_number`

or

`http://123.45.678.910:port_number`

On units that support SSL, the format for the ACS URL can also be:

`https://some_url.com:port_number`

or

`https://123.45.678.910:port_number`

## TR-064

DSL Forum TR-064 ("LAN Side CPE Configuration") is an extension of UPnP (Universal Plug-and-Play). It defines more services to locally manage the NVG599 device. While UPnP allows open access to configure the device's features, TR-064 requires a password to execute any command that changes the device's configuration.

---

### set management lanmgmt enable [ off | on ]

Turns TR-064 LAN side management services on or off. The default is **off**.

---

### set management shell idle-timeout [ 1...120 ]

Specifies a timeout period of inactivity for Telnet access to the NVG599 device, after which a user must re-log in to the NVG599. Default is **15** minutes for Telnet.

---

### set management shell ssh-port [ 1 - 65534 ]

Specifies the port number for secure shell (SSH) communication with the NVG599. Defaults to port **0** (off).

---

### set management shell telnet-port [ 1 - 65534 ]

Specifies the port number for Telnet (CLI) communication with the NVG599 device. Because port numbers in the range 0-1024 are used by other protocols, you should use numbers in the range 1025-65534 when assigning new port numbers to the NVG599 Telnet configuration interface. A setting of **0** (zero) will turn the server off.

---

### set management upnp enable [ off | on ]

Turns Universal Plug-and-Play (UPnP) on or off.

---

### set management web http-port [ 1 - 65534 ]

Specifies the port number for HTTP (Web) communication with the NVG599 device. Because port numbers in the range 0-1024 are used by other protocols, you should use numbers in the range 1025-65534 when assigning new port numbers to the NVG599 Web configuration interface. A setting of **0** (zero) will turn the server off.

---

### set management web https-port [ 1 - 65534 ]

Sets the secure Web access port for secure management of the NVG599. Default is port **443**.

---

### **set management web https-cert-cn *string***

Specifies a certificate from a trusted certificate authority to identify the secure Web access.

---

### **set management web idle-timeout [ 1...120 ]**

Specifies a timeout period of inactivity for HTTP access to the NVG599 device, after which a user must log in to the NVG599. Default is 5 minutes for HTTP.

---



**NOTE:**

You cannot specify a port setting of 0 (zero) for both the Web and Telnet ports at the same time. This would prevent you from accessing the NVG599.

---

---

### **set management web isp-help-desk *phone\_number\_string***

Specifies the ISP Help Desk phone number as it appears in the Web UI. For AT&T, the default is: 1-800-288-2020.

---

## **Remote Access Commands**

---

### **set management remote-access http-port [ 1 - 65534 ]**

Sets the Web access port for remote access management of the NVG599. Default is port **51003**.

---

### **set management remote-access http-idle-timeout [ 1...120 ]**

Specifies a timeout period of inactivity for remote HTTP access to the NVG599, after which a user must log in to the device. Default is 20 minutes for HTTP.

---

### **set management remote-access http-total-timeout [ 1...120 ]**

Specifies a total timeout period of inactivity for remote HTTP access to the NVG599, after which a user must log in to the device. Default is 20 minutes for HTTP.

---

### **set management remote-access http-max-clients *number***

Specifies the maximum number of client sessions for remote Web access management. Defaults to 1 (one).

---

### **set management remote-access https-port [ 1 - 65534 ]**

Sets the secure Web access port for remote access management of the NVG599. Default is port **51443**.

---

### **set management remote-access https-idle-timeout [ 1...120 ]**

Specifies a timeout period of inactivity for secure remote HTTPS access to the NVG599 device, after which a user must log in to the device. Default is 20 minutes for HTTPS.

---

### **set management remote-access https-total-timeout [ 1...120 ]**

Specifies a total timeout period of inactivity for secure remote HTTPS access to the NVG599 device, after which a user must log in to the device. Default is 20 minutes for HTTPS.

---

### **set management remote-access https-max-clients *number***

Specifies the maximum number of client sessions for secure remote Web access management. Defaults to 1.

---

---

---

### **set management remote-access telnet-port [ 1 - 65534 ]**

Specifies the port number for remote access Telnet (CLI) communication with the NVG599 device. Because port numbers in the range 0-1024 are used by other protocols, you should use numbers in the range 1025-65534 when assigning new port numbers to the NVG599 Telnet configuration interface. A setting of **0** (zero) will turn the server off. Defaults to port **0**.

---

---

### **set management remote-access telnet-idle-timeout [ 1...120 ]**

Specifies a timeout period of inactivity for remote Telnet access to the NVG599 device, after which a user must log in to the device. Default is 5 minutes for Telnet.

---

---

### **set management remote-access telnet-total-timeout [ 1...120 ]**

Specifies a total timeout period of inactivity for remote Telnet access to the NVG599 device, after which a user must log in to the device. Default is 20 minutes for Telnet.

---

---

### **set management remote-access telnet-max-clients *number***

Specifies the maximum number of client sessions for remote Telnet access management. Defaults to 4.

---

---

### **set management remote-access ssh-port [ 1 - 65534 ]**

Specifies the port number for secure shell (SSH) communication with the NVG599. Defaults to port 22.

---

---

### **set management remote-access ssh-idle-timeout [ 1...120 ]**

Specifies a timeout period of inactivity for remote secure shell (SSH) access to the NVG599 device, after which a user must log in to the device. Default is 5 minutes for SSH.

---

---

### **set management remote-access ssh-total-timeout [ 1...120 ]**

Specifies a total timeout period of inactivity for remote secure shell (SSH) access to the NVG599 device, after which a user must log in to the device. Default is 20 minutes for SSH.

---

---

### **set management remote-access ssh-max-clients *number***

Specifies the maximum number of client sessions for remote secure shell (SSH) access management. Defaults to 4.

---

---

### **set management lan-redirect enable [ off | on ]**

If set to **on** and a WAN failure condition is detected, the LAN client's browser is redirected to a Web page of failure and Help text information. The redirect will only occur once, as the Web UI maintains a state variable to determine whether the redirect has occurred; to continually redirect would block the user from reconfiguring the router.

---

---

### **set management lan-redirect missing-filter-notify [ on | off ]**

If set to **on** and a missing filter on the line is detected, the LAN client's browser is redirected to a Web page of failure and Help text information. The redirect will only occur once, as the Web UI maintains a state variable to determine whether the redirect has occurred; to continually redirect would block the user from reconfiguring the router.

---

### **set management lan-access wan-cpe-mgmt-block [ off | web | all ]**

Blocks management of the device from the LAN via the Web or all interface(s).

#### **TR-064**

DSL Forum TR-064 ("LAN Side CPE Configuration") is an extension of UPnP (Universal Plug-and-Play). It defines more services to locally manage the NVG599 device. While UPnP allows open access to configure the device's features, TR-064 requires a password to execute any command that changes the device's configuration.

---

### **set management lanmgmt enable [ off | on ]**

Turns TR-064 LAN-side management services on or off. The default is **off**.

## **Physical Interfaces Commands**

### **DSL interfaces**

---

### **set physical dsl enable [ off | on ]**

Turns the physical DSL interface off or on. Default is **on**.

---

### **set physical dsl dsl-mode [ auto | single | bonded ]**

Sets the mode for the DSL connection, whether a **single** line or **bonded**. If the default **auto** is set, the device will try both single and bonded, attempting to detect and lock on the mode in use.

---

### **set physical dsl loopback [ off | on ]**

Turns the DSL loopback mode off or on. Default is **off**.

---

### **set physical dsl annexm [ off | on ]**

Turns optional DSL Annex M off or on. Default is **off**. If enabled, data rates can be as high as 12 or 24 Mbit/s downstream and 3 Mbit/s upstream depending on the distance from the DSLAM to the customer's premises.

---

### **set physical dsl modulation auto [ off | on ]**

Turns automatic DSL modulation off or on. Default is **off**.

---

### **set physical dsl modulation vdsl2 [ off | on ]**

Turns VDSL2 DSL modulation off or on. Default is **on**.

---

### **set physical dsl modulation adsl2 [ off | on ]**

Turns ADSL2 DSL modulation off or on. Default is **on**.

---

### **set physical dsl modulation adsl2+ [ off | on ]**

Turns ADSL2+ DSL modulation off or on. Default is **on**.

---

### **set physical dsl modulation annex-l [ off | on ]**

Turns Annex-l DSL modulation off or on. Default is **off**.

---

---

---

### **set physical dsl modulation annex-m [ off | on ]**

Turns Annex-M DSL modulation off or on. Default is **off**.

---

### **set physical dsl profile-8a [ on | off ]**

Enables or disables VDSL2 profile 8a governing upstream and downstream bandwidth. Default is **on**.

---

### **set physical dsl profile-8b [ on | off ]**

Enables or disables VDSL2 profile 8b governing upstream and downstream bandwidth. Default is **on**.

---

### **set physical dsl profile-8c [ on | off ]**

Enables or disables VDSL2 profile 8c governing upstream and downstream bandwidth. Default is **on**.

---

### **set physical dsl profile-8d [ on | off ]**

Enables or disables VDSL2 profile 8d governing upstream and downstream bandwidth. Default is **on**.

---

### **set physical dsl profile-12a [ on | off ]**

Enables or disables VDSL2 profile 12a governing upstream and downstream bandwidth. Default is **on**.

---

### **set physical dsl profile-12b [ on | off ]**

Enables or disables VDSL2 profile 12b governing upstream and downstream bandwidth. Default is **on**.

---

### **set physical dsl profile-17a [ on | off ]**

Enables or disables VDSL2 profile 17a governing upstream and downstream bandwidth. Default is **on**.

---

### **set physical dsl profile-30a [ on | off ]**

Enables or disables VDSL2 profile 30a governing upstream and downstream bandwidth. Default is **off**.

---

### **set physical dsl bit-swap [ on | off ]**

Turns DSL bit-swapping on or off. Bit-swapping is resilient to loss of hand-shake commands. Default is **on**.

---

### **set physical dsl trellis [ on | off ]**

Turns trellis error correction encoding on or off. Default is **on**.

---

### **set physical dsl vectoring-enable [ off | on ]**

Enables or disables VDSL2 vectoring. Vectoring enables VDSL2 to achieve its highest potential data rates, exceeding 100 Mbps. Default is **off**.

---

### **set physical dsl vectoring-timeout-ms *milliseconds***

If **vectoring-enable** is set to **on**, specifies a timeout interval in milliseconds. Default is **5000**.

---



---

**set physical dsl nlnm-threshold [ 0 - 480 ]**

Specifies the New Low Noise Model (NLNM) value between 0 and 480. Default is **60**.

---

**set physical dsl transport [ atm | ptm | auto | off ]**

Sets the DSL transport mode: Asynchronous (**atm**), Packet (**ptm**), Automatic (**auto**), or none (**off**). Default is **ptm**.

---

**set physical dsl atm vcc 1 enable [ off | on ]**

Turns ATM on or off on vcc 1. Default is **on**.

---

**set physical dsl atm vcc 1 aal-type [ aal5 | aal0pkt | aal0cell ]**

Sets the ATM Adaptation Layer type (**aal-type**): AAL5, AAL0-packet, or AAL0-cell. Default is **aal5**.

---

**set physical dsl atm vcc 1 datapath [ phy0fast | phy0interleaved ]**

Sets the ATM datapath, Fast Path or Interleaved. Default is **phy0fast**.

---

**set physical dsl atm vcc 1 encap-type [ llcsnap-eth | llcsnap-rtip | llcencaps-ppp | vcmux-eth | vcmux-ipoa | vcmux-pppoa ]**

Specifies the data link encapsulation type. Default is **llcsnap-eth**.

---

**set physical dsl atm vcc 1 vpi [ 0 - 255 ]**

Sets the virtual path identifier (VPI) for the circuit. Default is **0**.

---

**set physical dsl atm vcc 1 vci [ 32 - 65535 ]**

Sets the virtual channel identifier (VCI) for the circuit. Default is **35**.

---

**set physical dsl atm vcc 2 enable [ off | on ]**

Turns ATM on or off on vcc 2. Default is **on**.

---

**set physical dsl atm vcc 2 aal-type [ aal5 | aal0pkt | aal0cell ]**

Sets the ATM adaptation layer type (**aal-type**): AAL5, AAL0-packet, or AAL0-cell. Default is **aal5**.

---

**set physical dsl atm vcc 2 datapath [ phy0fast | phy0interleaved ]**

Sets the ATM datapath, Fast Path or Interleaved. Default is **phy0fast**.

---

**set physical dsl atm vcc 2 encap-type [ llcsnap-eth | llcsnap-rtip | llcencaps-ppp | vcmux-eth | vcmux-ipoa | vcmux-pppoa ]**

Specifies the data link encapsulation type. Default is **llcsnap-eth**.

---

**set physical dsl atm vcc 2 vpi [ 0 - 255 ]**

Sets the virtual path identifier (VPI) for the circuit. Default is **8**.

---

---

---

**set physical dsl atm vcc 2 vci [ 32 - 65535 ]**

Sets the virtual channel identifier (VCI) for the circuit. Default is **35**.

---

**set physical dsl atm vcc *vcc\_num* tx-queue *queue\_name***

Attaches the egress queue template to the ATM VC when the queue type is egress.

---

**set physical dsl atm vcc *vcc\_num* rx-queue *queue\_name***

Attaches the ingress queue to the ATM VC when the queue type is ingress.

---

**set physical dsl ptm datapath [ phy0fast | phy0interleaved ]**

Sets the ATM datapath, Fast Path or Interleaved. Default is **phy0fast**.

---

**set physical dsl ptm priority [ low | high ]**

Sets the packet transfer mode (PTM) priority. Default is **low**.

---

**set physical dsl ptm tx-queue *queue\_name***

Attaches the egress queue template to the PTM interface when the queue type is egress.

---

**set physical dsl ptm rx-queue *queue\_name***

Attaches the ingress queue to the PTM interface when the queue type is ingress.

---

**set physical dsl atm vcc 1 auto-vpi-vci [ on | off ]**

Turns automatic VPI/VCI detection on or off. If you leave the default **on**, the device will try a series of VPI/VCI pairs that are commonly used by service providers. When one pair succeeds, the device will use this one for future connections.

---

**set physical dsl atm vcc 1 vpi-vci-list *vpi\_vci\_pairs***

Specifies the series of VPI/VCI pairs that the device will use to attempt a connection. The default set ("0/35 8/35 0/43 0/51 0/59 8/43 8/51 8/59") can be changed.

---

**set physical dsl atm vcc 1 qos enable [ off | on ]**

Turns QoS off or on on the virtual circuit. Default is **off**.

---

**set physical dsl power-save enable [ off | on ]**

Turns power saving mode off or on. Default is **off**.

## Ethernet Interfaces

---

### **set physical enet [ 1 - 4 ] mac-addr-override *mac\_addr***

You can override your NVG599 device's Ethernet MAC address with any necessary setting. Some ISPs require your account to be identified by the MAC address, among other things. Enter your 12-character Ethernet MAC override address as instructed by your service provider, for example: 12 34 AB CD 19 64

### **set physical enet [ 1 - 4 ] port media [ auto | 100-fd | 100-hd | 10-fd | 10-hd ]**

Sets the Ethernet port's media flow control: Automatic, 100 Mbps Full-Duplex, 100 Mbps Half-Duplex, 10 Mbps Full-Duplex, or 10 Mbps Half-Duplex. Default is **auto**.

### **set physical enet [ 1 - 4 ] port mdix [ auto | on | off ]**

Sets the Ethernet port's crossover detection. Default is **off**.

### **set physical enet [ 1 - 4 ] tx-queue *queue\_name***

Attaches the egress queue template to the Ethernet interface when the queue type is egress.

### **set physical enet [ 1 - 4 ] rx-queue *queue\_name***

Attaches the ingress queue to the Ethernet interface when the queue type is ingress.

### **set physical enet [ 1 - 4 ] port power-save enable ""**

Turns power saving mode off or on.

### **set physical ensw max-age *seconds***

Sets the maximum delay on the Ethernet switch in seconds. Default is **300** (5 minutes).

### **set physical ensw qos-mode [ off | p-bit ]**

Sets QoS up on Ethernet switch, classified by priority-bit mapping. Default is **off**. When **p-bit** is selected, packets will be mapped from their priority (even if untagged) to one of four queues per-port in the Ethernet switch.

See ["Quality of Service \(QoS\) Examples" on page 217](#) for more information.



**NOTE:**

This setting only applies to packets sent from the host CPU to a switch port; it does not apply to port-to-port traffic.

### **set physical ensw p-bit-map *pbit-to-4queue-map***

Sets the mapping from the 8 priority-bits to the four queues in the Ethernet switch. The lowest priority queue is "1", and the highest priority queue is "4".

**Example:** Mapping is "1 1 2 2 3 3 4 4", where priority bit values 0 and 1 would map to queue 1, and values 2 and 3 would map to queue 2, etc.

---

## Wireless Interfaces

---

### set physical wireless enable [ on | off ]

Enables or disables the wireless capability for supported Wi-Fi devices. Default is **on**.

---

### set physical wireless standard [ bg | b-only | g-only | bgn | n-only | an | a-only ]

Sets and locks the NVG599 into the wireless transmission mode you want: **bg**, **b-only**, **g-only**, **bgn**, **n-only**, **an**, or **a-only**. For compatibility with clients using 802.11b (up to 11 Mbps transmission), 802.11g (up to 20+ Mbps), 802.11a (up to 54 Mbit/s using the 5 GHz band), or 802.11n (from 54 Mbit/s to 600 Mbit/s with the use of four spatial streams at a channel width of 40 MHz), select **b/g/n**. To limit your wireless LAN to one mode or the other, select **g-only**, **n-only**, **a-only**, or **b-only**, or some combination that applies to your setup. Default is **bgn**.

---

### set physical wireless auto-channel [ off | on ]

Turns auto-channel selection on or off.

---

### set physical wireless bandwidth [ narrow | wide ]

Specifies whether the Wi-Fi channel is narrow or wide band. Default is **narrow** in compliance with FCC requirements.

---

### set physical wireless default-channel [ 1... 11 ]

(1 through 11, for North America) on which the network will broadcast. This is a frequency range within the 2.4 GHz band. Channel selection can have a significant impact on performance, depending on other wireless activity close to this router. Channel selection is not necessary at the client computers; the clients will scan the available channels seeking access points using the same SSID as the client. Defaults to **6**.

---

### set physical wireless power [ 1 - 100 ]

Sets some value lower than 100 percent transmit power if your NVG599 device is located close to other Wi-Fi devices and causes interference. Defaults to **100** (percent).

---

### set physical wireless mul2uni [ off | on ]

Turns wireless “many-to-one” packet scheduling off or on. Default is **off**.

---

### set physical wireless ssid 1 enable [ on | off ]

Enables or disables the first (default) Wi-Fi SSID.

---

### set physical wireless ssid 1 name *name*

Specifies a name for the first Wi-Fi SSID. Defaults to a unique value per router of the form “ATTxxx”.

---

### set physical wireless ssid 1 access-type [ none | allow | deny ]

Specifies the type of address list for defining MAC address filtering. If set to **allow**, only hosts with the specified addresses will be permitted to join the WLAN of the specified SSID. If set to **deny**, any hosts except those with the specified addresses will be permitted to join the specified SSID. Default is **none**.

---

---

**set physical wireless ssid 1 access-list *mac\_address***

Specifies the MAC address of devices controlled by MAC address filtering.

---

**set physical wireless ssid 1 hidden [ off | on ]**

Enables or disables SSID hiding for the specified SSID. If set to **on**, the specified SSID will not appear on client scans. Clients must log into the SSID with the exact SSID name and credentials specified for that SSID.

---

**set physical wireless ssid 1 isolate [ off | on ]**

If set to **on**, blocks wireless clients from communicating with other wireless clients on the WLAN side of the NVG599. Defaults to **off**.

---

**set physical wireless ssid 1 security [ none | wep | wpa ]**

Sets the wireless privacy type: **none**, **wep**, or **wpa-psk**. Default is **none**.

---

**set physical wireless ssid 2 enable [ off | on ]**

Enables or disables the second available SSID.

---

**set physical wireless ssid 3 enable [ off | on ]**

Enables or disables the third available SSID.

---

**set physical wireless ssid 4 enable [ off | on ]**

Enables or disables the fourth available SSID.

---

**set physical wireless wps [ on | off ]**

Enables or disables Wi-Fi Protected Setup (WPS) for simplified security configuration with Wi-Fi clients that support it.

---

**set physical wireless wmm enable [ off | on ]**

Enables or disables Wi-Fi multimedia settings for multimedia queueing characteristics.

---

**set physical wireless wmm power-save [ off | on ]**

Turns power saving mode off or on for wireless multimedia when **wmm enable** is on. Default is **on**.

---

---

## PPPoE Relay Commands

---



### NOTE:

When configuring a PPPoE connection, you must also configure the required PPPoE authentication details (such as user name and password combinations) on the client computer.

---

### **set pppoe-relay enable [ on | off ]**

Allows the NVG599 device to forward PPPoE packets. Default is **on**.

---

### **set pppoe-relay max-sessions [ 0... 4 ]**

Specifies the maximum number of PPPoE relay sessions. Default is **4**.

## NAT Pinhole Commands

NAT pinholes let you pass specific types of network traffic through the NAT interfaces on the NVG599. NAT pinholes allow you to route selected types of network traffic, such as FTP requests or HTTP (Web) connections, to a specific host behind the NVG599 transparently.

To set up NAT pinholes, you identify the type(s) of traffic you want to redirect by port number, and you specify the internal host to which each specified type of traffic should be directed.

The following list identifies protocol type and port number for common TCP/IP protocols:

- ◆ FTP (TCP 21)
  - ◆ Telnet (TCP 23)
  - ◆ SMTP (TCP 25),
  - ◆ TFTP (UDP 69)
- 

### **set pinhole name *name* protocol [ tcp | udp ]**

Specifies the identifier for the entry in the NVG599 device's pinhole table. You can name pinhole table entries sequentially (1, 2, 3), by port number (21, 80, 23), by protocol, or by some other naming scheme. Specifies the type of protocol being redirected.

---

### **set pinhole name *name* ext-port-range [ 0 - 49151 ]**

Specifies the first and last port number in the range being translated.

---

### **set pinhole name *name* int-addr *ipaddr***

Specifies the IP address of the internal host to which traffic of the specified type should be transferred.

---

### **set pinhole name *name* int-start-port [ 0 - 65535 ]**

Specifies the port number your NVG599 device should use when forwarding traffic of the specified type. Under most circumstances, you would use the same number for the external and internal port.

## Security Stateful Packet Inspection (SPI) Commands

---

### set security firewall-level [ low | high | off ]

All computer operating systems are vulnerable to attack from outside sources, typically at the operating system or Internet Protocol (IP) layers. Stateful inspection firewalls intercept and analyze incoming data packets to determine whether they should be admitted to your private LAN, based on multiple criteria, or blocked. Stateful inspection improves security by tracking data packets over a period of time, examining incoming and outgoing packets. Outgoing packets that request specific types of incoming packets are tracked; only those incoming packets constituting a proper response are allowed through the firewall.

The **high** setting is recommended, but for special circumstances, a low level of firewall protection is available. You can also turn all firewall protection **off**. Defaults to **low**.

---

### set security spi ip4 invalid-addr-drop [ on | off ]

Enables or disables whether broadband packets with invalid source or destination addresses should be dropped. Default is **on**.

---

### set security spi ip4 private-addr-drop [ on | off ]

Enables or disables whether broadband packets with private source or destination addresses should be dropped. Default is **off**.

---

### set security spi unknown-ethertypes-drop [ on | off ]

Enables or disables whether packets with unknown ether types are to be dropped. Default is **on**.

---

### set security spi portscan-protect [ on | off ]

Enables or disables whether to detect and drop port scans. Default is **on**.

---

### set security spi invalid-tcp-flags-drop [ on | off ]

Enables or disables whether packets with invalid TCP flag settings (NULL, FIN, Xmas, etc.) are to be dropped. Default is **on**.

---

### set security spi ip4 invalid-addr-drop [ on | off ]

Blocks broad sets of addresses that should not be used as either source or destination addresses, or both. These include the following:

---

IP address/mask	Source or destination
10.0.0.0/8	source
192.168.0.0/16	source
169.254.0.0/16	source
172.16.0.0/12	source
224.0.0.0/4	Source / destination
224.0.0.0/5	Source / destination
0.0.0.0/8	Source / destination
255.255.255.255	destination

The default is **on**.

---

---

---

**set security spi ip4 private-addr-drop [ off | on ]**

Drops packets sourced or destined for private IPv4 addresses. The default is **off**.

---

**set security spi flood-limit enable [ on | off ]**

Enables or disables whether packet flooding should be detected and offending packets be dropped. Default is **on**.

---

**set security spi flood-limit limit *pps\_value***

Sets a maximum packets-per-second (PPS) value for packet flood criterion. Defaults to **4**.

---

**set security spi flood-limit burst-limit *max\_value***

Sets a maximum value in a packet-burst for packet flood criterion. Defaults to **8**.

---

**set security spi flood-limit icmp enable [ on | off ]**

Enables or disables whether ICMP packet flooding should be detected and offending packets be dropped. Defaults to **on**.

---

**set security spi flood-limit udp enable [ off | on ]**

Enables or disables whether UDP packet flooding should be detected and offending packets be dropped. Defaults to **off**.

---

**set security spi flood-limit tcp enable [ off | on ]**

Enables or disables whether TCP packet flooding should be detected and offending packets be dropped. Defaults to **off**.

---

**set security spi flood-limit tcp syn-cookie [ on | off ]**

Allows TCP SYN cookies flooding to be excluded. Defaults to **on**.

---

**Reflexive ACL**

---

**set security spi ip6 allow-inbound [ on | off ]**

Turns reflexive ACL on or off for IPv6.

Reflexive access control lists (ACL) provide that Layer 4 session information is used to make decisions about what packets to route. Reflexive ACL reduces exposure to spoofing and denial-of-service attacks, because desired inbound packet flows are usually in response to outbound traffic.

ARRIS 9.x DSL gateways use the relevant session information about whether the packet flow was initiated from the LAN side (upstream) or WAN side (downstream). If the parameter **security.spi.ip6.allow-inbound** is set to **off**, then sessions which are initiated from the WAN side are disallowed. Upstream sessions are never precluded because of reflexive ACL. (Of course there may be other reasons that particular packets are dropped.)

For IPv4, NAT is generally enabled, thus reflexive ACL is usually not an issue.



## VoIP Commands

### (supported models only)

Voice-over-IP (VoIP) refers to the ability to make voice telephone calls over the Internet. This differs from traditional phone calls that use the public switched telephone network (PSTN). VoIP calls use an Internet protocol, Session Initiation Protocol (SIP), to transmit sound over a network or the Internet in the form of data packets. Certain ARRIS gateway models have one or more voice ports for connecting telephone handsets. These models support VoIP. If your gateway is a VoIP model, you can configure the VoIP features.

## VoIP Profile Settings

---

### **set voip profile [ 1 - 4 ] prof-enable [ on | off ]**

Enables or disables the use and configuration of the specified VoIP profile on the NVG599.

---

### **set voip profile [ 1 - 4 ] proxy-server *address***

Specifies the IP address or fully-qualified domain name of the SIP proxy server that stations using the profile will connect to.

---

### **set voip profile [ 1 - 4 ] proxy-port *port***

Sets the well-known port number the station using the profile will use to connect to the SIP proxy. Default is **5060**.

---

### **set voip profile [ 1 - 4 ] proxy-transport **udp****

Assigns a proxy transport protocol to the VoIP profile. Default is **udp**.

---

### **set voip profile [ 1 - 4 ] registrar-server *address***

Specifies the IP address or fully-qualified domain name of the SIP registrar (server) that stations using the profile will connect to.

---

### **set voip profile [ 1 - 4 ] registrar-port *portnumber***

Sets the well-known port number the user agent using the profile will use to connect to the SIP registrar. Default is **5060**.

---

### **set voip profile [ 1 - 4 ] registrar-transport [ tcp | udp | tls ]**

Assigns a registrar transport protocol to the VoIP profile. Default is **udp**.

---

### **set voip profile [ 1 - 4 ] sip-expires [ 0 – 65535 ]**

Specifies the SIP registration server timeout duration from 0 – 65535 seconds for the specified profile. Default is **3600** (1 hour).

---

### **set voip profile [ 1 - 4 ] outbound-proxy-server *address***

Specifies the SIP outbound proxy server for the specified profile by fully qualified server name or IP address.

---

### **set voip profile [ 1 - 4 ] outbound-proxy-port *portnumber***

Specifies the SIP outbound proxy server port for the specified profile. Default is **5060**.

---

---

---

**set voip profile [ 1 - 4 ] sip-user-domain *name***

Sets the SIP user domain value to be used by the VoIP profile.

---

**set voip profile [ 1 - 4 ] sip-user-port [ 1 - 65535 ]**

Specifies the SIP user port for the specified phone, Default is **5060**.

---

**set voip profile [ 1 - 4 ] sip-user-transport [ tcp | udp ]**

Assigns a transport protocol to the identified VoIP SIP profile. Default is **udp**.

---

**set voip profile [ 1 - 4 ] invite-expires *seconds***

Assigns the “lifespan” of a SIP INVITE message for the identified profile.

---

**set voip profile [ 1 - 4 ] reinvite-expires *seconds***

Sets the amount of time a SIP user agent with the named profile will consider a re-INVITE message valid.

---

**set voip profile [ 1 - 4 ] reg-retry-interval *seconds***

Specifies the number of seconds that must elapse before a SIP user agent using the named profile may attempt to retry registration.

---

**set voip profile [ 1 - 4 ] reg-min-expires *seconds***

Assign the profile a minimum length of time until a registration expires and must be renewed.

---

**set voip profile [ 1 - 4 ] registration-period *seconds***

Sets the amount of time that a registration remains valid.

---

**set voip profile [ 1 - 4 ] max-retrans-invite *times***

Assigns the profile a maximum number of INVITE message retries. Default: **3**.

---

**set voip profile [ 1 - 4 ] max-retrans-non-invite *times***

Assigns the profile a maximum number of non-INVITE message retransmissions. Default: **4**.

---

**set voip profile [ 1 - 4 ] sip-publish-method PUBLISH**

Sets the specified profile’s SIP event state publication method to PUBLISH.

---

**set voip profile [ 1 - 4 ] sip-publish-destination "DEFAULT"**

Sets the specified profile’s SIP event state published destination to DEFAULT.

---

**set voip profile [ 1 - 4 ] sip-publish-destination2 "NULL"**

Clears (assign to NULL) the specified SIP profile’s second published destination.

---

**set voip profile [ 1 - 4 ] sip-publish-invocation never**

Sets the specified profile to never invoke PUBLISH.

---

**set voip profile [ 1 - 4 ] sip-publish-interval seconds**

Assigns the publication interval to the specified profile.

---

**set voip profile [ 1 - 4 ] sip-publish-count -1**

Sets the number of SIP publication events for the profile.

---

**set voip profile [ 1 - 4 ] sip-advanced-setting sip-hk-flash-mode info**

Assigns a SIP HK Flash mode to the profile.

---

**set voip profile [ 1 - 4 ] sip-advanced-setting sip-session-refresher auto**

Assigns a SIP session refresh method to the identified profile.

---

**set voip profile [ 1 - 4 ] sip-advanced-setting sip-session-timer-value [value]**

Configures the SIP session timer value for the profile. Default: 2280.

---

**set voip profile [ 1 - 4 ] sip-advanced-setting sip-dynamic-payload [value]**

Sets the dynamic payload value for the identified profile. Default: 101.

---

**set voip profile [ 1 - 4 ] sip-advanced-setting sip-dtmf-mode [inband | rfc2833 | info]**

Assigns a DTMF signaling mode for the SIP profile.

- ◆ **inband**: sends the DTMF digits as a normal inband tone.
- ◆ **rfc2833**: (default) sends the DTMF digits as an event as part of the RTP packet header information.
- ◆ **info**: sends the DTMF digits in the SIP INFO message.

Default: rfc2833.

---

**set voip profile [ 1 - 4 ] sip-advanced-setting sip-digit-map**  
"O=15,I=6,S=3(\*#101<:@C03>|\*#103<:@C06>|T0|T\*xx|T\*xxx|E[2-9]11|E[01]911|1[2-9]xxxxxxxx|T[2-9]xxxxxx|[2-9]xxxxxxxx|n.)"

Assigns the specified digit map to the SIP profile.

---

**set voip profile [ 1 - 4 ] sip-advanced-setting sip-compact-header [ on | off ]**

Sets the profile to use compact format when set to **on**. Sends the SIP messages with compact headers, reducing the size of the SIP messages.

---

**set voip profile [ 1 - 4 ] sip-advanced-setting sip-q-value [ 0 - 10 ]**

Assigns a prioritizing SIP q-value to the profile. Default: 10.

---

---

---

**set voip profile [ 1 - 4 ] sip-advanced-setting sip-qos-tos [ 0 - 255 ]**

Specifies the SIP DiffServ type of service (ToS) values for Quality of Service (QoS) assignment. Default: **160**.

---

**set voip profile [ 1 - 4 ] sip-advanced-setting sip-qos-p-bit [ 0 - 7 ]**

Assigns a Quality of Service priority bit (p-bit) value to the SIP profile. Default: **6**.

---

**set voip profile [ 1 - 4 ] sip-advanced-setting sip-qos-marker [ value ]**

Assigns a QoS packet marker to the SIP profile. Default: **VO**.

---

**set voip profile [ 1 - 4 ] sip-advanced-setting fax-redundancy-level [ 0 - 1 ]**

Specifies the level of fax redundancy for t38 fax data rate management. Default: **1**.

---

**set voip profile [ 1 - 4 ] sip-advanced-setting sip-init-de-register [ on | off ]**

Turns SIP de-registration on or off for the profile. Default: or both.

---

**set voip profile [ 1 - 4 ] sip-advanced-setting sip-known-ip-list "[string]"**

Specifies a known IP address list of SIP servers for the SIP profile.

---

**set voip profile [ 1 - 4 ] sip-advanced-setting sip-allow-ip-list "[string]"**

Defines a string of named SIP servers that the profile may use.

---

**set voip profile [ 1 - 4 ] sip-advanced-setting sip-t1-timer-value 500**

Assigns a SIP t1 (estimated round trip time) value to the profile.

---

**set voip profile [ 1 - 4 ] sip-advanced-setting sip-t2-timer-value 4000**

Assigns a SIP t2 (maximum non-INVITE retransmit time) value to the profile.

---

**set voip profile [ 1 - 4 ] sip-advanced-setting sip-t4-timer-value 5000**

Assigns a SIP t4 (message clear time) value to the profile.

---

**set voip profile [ 1 - 4 ] sip-advanced-setting sip-timer-a-value 500**

Assigns a SIP A timer (UDP INVITE retransmit interval) value to the profile.

---

**set voip profile [ 1 - 4 ] sip-advanced-setting sip-timer-b-value 32000**

Assigns a SIP B timer (INVITE transaction timeout) value to the profile.

---

**set voip profile [ 1 - 4 ] sip-advanced-setting sip-timer-c-value 0**

Assigns a SIP C timer value to the profile.

---

**set voip profile [ 1 - 4 ] sip-advanced-setting sip-timer-d-value 32000**

Assigns a SIP D timer (response retransmission time) value to the profile.

---

**set voip profile [ 1 - 4 ] sip-advanced-setting sip-timer-e-value 500**

Assigns a SIP E timer (UDP non-INVITE retransmit interval) value to the profile.

---

**set voip profile [ 1 - 4 ] sip-advanced-setting sip-timer-f-value 32000**

Assigns a SIP F timer (non-INVITE retransmit interval) value to the profile.

---

**set voip profile [ 1 - 4 ] sip-advanced-setting sip-timer-g-value 500**

Assigns a SIP G timer (INVITE response retransmit interval) value to the profile.

---

**set voip profile [ 1 - 4 ] sip-advanced-setting sip-timer-h-value 32000**

Assigns a SIP H timer (ACK receipt wait time) value to the profile.

---

**set voip profile [ 1 - 4 ] sip-advanced-setting sip-timer-i-value 5000**

Assigns a SIP I timer (ACK retransmit wait time) value to the profile.

---

**set voip profile [ 1 - 4 ] sip-advanced-setting sip-timer-j-value 32000**

Assigns a SIP J timer (non-INVITE retransmit request wait time) value to the profile.

---

**set voip profile [ 1 - 4 ] sip-advanced-setting sip-timer-k-value 0**

Assigns a SIP K timer (response retransmission wait time) value to the profile.

---

**set voip profile [ 1 - 4 ] sip-advanced-setting sip-reset-code "code"**

Sets the SIP reset code for the profile. Default: **101**

---

**set voip profile [ 1 - 4 ] sip-advanced-setting sip-timer-shortinterdigit-value [value]**

Sets an interdigit (short) timer value for the profile. Default: **0**

---

**set voip profile [ 1 - 4 ] sip-advanced-setting sip-timer-interdigit-value [value]**

Sets an interdigit timer value to the profile. Default: **0**.

---

**set voip profile [ 1 - 4 ] rtp-advanced-setting rtp-qos-tos [value]**

Assigns a Real Time Protocol terms of service number code to the VoIP profile. Default: **184**.

---

**set voip profile [ 1 - 4 ] rtp-advanced-setting rtp-qos-p-bit [ 0 - 7]**

Sets a Real Time Protocol Priority bit (P-bit) value to the VoIP profile. Default: **6**.

---

**set voip profile [ 1 - 4 ] rtp-advanced-setting rtp-qos-marker "string"**

Assigns a Real Time Protocol QoS packet marker to the VoIP profile. Default **VO**.

---

---

---

**set voip profile [ 1 - 4 ] rtp-advanced-setting rtp-port-range-start [ value ]**

Defines the beginning of the VoIP Real Time Protocol port range assigned to the profile. Default: **6002**.

---

**set voip profile [ 1 - 4 ] rtp-advanced-setting rtp-port-range-end [ value ]**

Defines the end of the VoIP Real Time Protocol port range assigned to the profile. Default: **6200**.

---

**set voip profile [ 1 - 4 ] rtp-advanced-setting rtcp-option [ on | off ]**

Configures the Real Time Control Protocol (RTCP) setting for the VoIP profile.

---

**set voip profile [ 1 - 4 ] rtp-advanced-setting rtcp-repeat-interval [ value ]**

Assigns a Real Time Control Protocol repeat interval value to the VoIP RTP profile. Default: **5000**

---

**set voip profile [ 1 - 4 ] advanced-telephony-setting fxs-port-setting-for-fxo [ none | fxs1 | fxs2 | both | emgncy ]**

Sets a port to be used for the FXS (foreign exchange station) interface port to the FXO (foreign exchange office) interface—the phone—port. Default is **none**.

---

**set voip profile [ 1 - 4 ] advanced-telephony-setting t38-option [ on | off ]**

Enables or disables T.38 fax capability for the VoIP profile.

---

**set voip profile [ 1 - 4 ] advanced-telephony-setting sip-dynamic-line-selection [ on | off ]**

Turns dynamic (next available) line selection off or on for the identified VoIP profile. Default is **off**.

---

**set voip profile [ 1 - 4 ] advanced-telephony-setting sip-dns-ns [ on | off ]**

Enables or disables SIP DNS NS records (for Authoritative Name Server zone specification).

---

**set voip profile [ 1 - 4 ] advanced-telephony-setting sip-dns-naptr [ on | off ]**

Enables or disables the Name Authority Pointer (NAPTR) DNS function in the SIP profile.

---

**set voip profile [ 1 - 4 ] advanced-telephony-setting sip-dns-srv [ on | off ]**

Enables or disables the use of DNS Service Locator (SRV) functions in the profile.

---

**set voip profile [ 1 - 4 ] advanced-telephony-setting announcement-setting announcement-battery-alert-option [ on | off ]**

Enables or disables the autonomous announcement of battery alert conditions in the VoIP profile.

---

**set voip profile [ 1 - 4 ] advanced-telephony-setting battery-notification-setting battery-notification-interval [ value ]**

Specifies the number of seconds between battery notification messages.

---

**set voip profile [ 1 - 4 ] advanced-telephony-setting battery-notification-setting battery-notification-tod-start "[HH:MM]AM | [HH:MM]PM"**

Assigns a start time for battery notification message generation to the profile.

---

**set voip profile [ 1 - 4 ] advanced-telephony-setting battery-notification-setting battery-notification-tod-end "[HH:MM]AM | [HH:MM]PM"**

Assigns an end time for battery notification message generation to the profile.

---

**set voip profile [ 1 - 4 ] advanced-telephony-setting testline-setting voip-testline-mode Always**

Assigns a line test mode to the VoIP profile specified.

---

**set voip profile [ 1 - 4 ] advanced-telephony-setting testline-setting voip-testline-maxlenX5s [value]**

Sets the maximum X5s length to the profile's testline settings. Default: 6.

---

**set voip profile [ 1 - 4 ] advanced-telephony-setting testline-setting voip-testline-maxfreq [value]**

Sets the maximum frequency of line tests for the VoIP profile. Default: 10.

---

**set voip profile [ 1 - 4 ] user-account [ 1 - 4 ] enable [ on | off ]**

Enables or disables the identified VoIP user account (individual account) on the specified VoIP profile.



**NOTE:**

User account settings may be specified for disabled user accounts, but the features will not be available unless the account is enabled.

---

**set voip profile [ 1 - 4 ] user-account [ 1 - 4 ] voip-testline-option [ on | off ]**

Enables or disables the test line option for the named user account on the VoIP profile. Default: **off**.

---

**set voip profile [ 1 - 4 ] user-account [ 1 - 4 ] fxs-line 1**

Sets a line in the user account to support FXS (foreign exchange station) interface. Default is **none**.

---

**set voip profile [ 1 - 4 ] user-account [ 1 - 4 ] sip-user-disp-name "[string]"**

Assigns a display name for the identified user account on the specified VoIP profile. Default: **1000**.

---

**set voip profile [ 1 - 4 ] user-account [ 1 - 4 ] sip-user-name "[string]"**

Adds a user name value to the VoIP profile SIP user account. Default: **1000**.

---

**set voip profile [ 1 - 4 ] user-account [ 1 - 4 ] sip-user-password "[string]"**

Sets the SIP password for the user account on the VoIP profile.

---

---

**set voip profile [ 1 - 4 ] user-account [ 1 - 4 ] sip-user-auth-id “[string]”**

Defines a user authentication ID value for the user account on the VoIP profile. Default: **1000**.

---

**set voip profile [ 1 - 4 ] user-account [ 1 - 4 ] sip-uri ""**

Assigns a SIP Uniform Resource Identifier (URI) to the specified user account.

---

**set voip profile [ 1 - 4 ] user-account [ 1 - 4 ] sip-subscribe-expires [time]**

Sets the expiration timer value for SIP subscriptions by the identified user account. Default: **3600**.

---

**set voip profile [ 1 - 4 ] user-account [ 1 - 4 ] sip-service-outage-detect [ on | off ]**

Enables or disables the detection of SIP service outages by the user account.

---

**set voip profile [ 1 - 4 ] user-account [ 1 - 4 ] codec G711U priority [ 1 - 7 | none ]**

Assigns a priority value to the Mu-law (G711U) codec on the user account. Default: **1**

---

**set voip profile [ 1 - 4 ] user-account [ 1 - 4 ] codec G711U packetization-time [value]**

Assigns a packetization time value to the Mu-law (G711U) codec on the user account. Default: **20**

---

**set voip profile [ 1 - 4 ] user-account [ 1 - 4 ] codec G711A priority [ 1 - 7 | none ]**

Assigns a priority value to the a-law (G711A) codec on the user account. Default: **2**

---

**set voip profile [ 1 - 4 ] user-account [ 1 - 4 ] codec G711A packetization-time [value]**

Assigns a packetization time value to the a-law (G711A) codec on the user account. Default: **20**

---

**set voip profile [ 1 - 4 ] user-account [ 1 - 4 ] codec G729 priority [ 1 - 7 | none ]**

Assigns a priority value to the G.729 codec on the user account. Default: **7**

---

**set voip profile [ 1 - 4 ] user-account [ 1 - 4 ] codec G729 packetization-time [value]**

Assigns a packetization time value to the G.729 codec on the user account. Default: **20**

---

**set voip profile [ 1 - 4 ] user-account [ 1 - 4 ] codec G729 annexb-support [ on | off ]**

Enables or disables G.729 Annex-B support on the specified user account. Default: **off**.

---

**set voip profile [ 1 - 4 ] user-account [ 1 - 4 ] codec G726\_16 priority [ 1 - 7 | none ]**

Assigns a priority value to the 16 kbit/s G.726 codec on the user account. Default: **3**.



---

**set voip profile [ 1 - 4 ] user-account [ 1 - 4 ] codec G726\_16 payload-type [value]**

Assigns a payload value to the 16 kbit/s G.726 codec on the user account. Default: **102**.

---

**set voip profile [ 1 - 4 ] user-account [ 1 - 4 ] codec G726\_16 packetization-time [value]**

Assigns a packetization time value to the 16 kbit/s G.726 codec on the user account. Default: **20**

---

**set voip profile [ 1 - 4 ] user-account [ 1 - 4 ] codec G726\_24 priority [ 1 - 7 | none ]**

Assigns a priority value to the 24 kbit/s G.726 codec on the user account. Default: **4**

---

**set voip profile [ 1 - 4 ] user-account [ 1 - 4 ] codec G726\_24 payload-type [value]**

Assigns a payload value to the 24 kbit/s G.726 codec on the user account. Default: **103**

---

**set voip profile [ 1 - 4 ] user-account [ 1 - 4 ] codec G726\_24 packetization-time [value]**

Assigns a packetization time value to the 24 kbit/s G.726 codec on the user account. Default: **20**

---

**set voip profile [ 1 - 4 ] user-account [ 1 - 4 ] codec G726\_32 priority [ 1 - 7 | none ]**

Assigns a priority value to the 32 kbit/s G.726 codec on the user account. Default: **5**.

---

**set voip profile [ 1 - 4 ] user-account [ 1 - 4 ] codec G726\_32 packetization-time [value]**

Assigns a packetization time value to the 32 kbit/s G.726 codec on the user account. Default: **20**

---

**set voip profile [ 1 - 4 ] user-account [ 1 - 4 ] codec G726\_40 priority [ 1 - 7 | none ]**

Assigns a priority value to the 40 kbit/s G.726 codec on the user account. Default: **6**.

---

**set voip profile [ 1 - 4 ] user-account [ 1 - 4 ] codec G726\_40 payload-type [value]**

Assigns a payload value to the 40 kbit/s G.726 codec on the user account. Default: **105**.

---

**set voip profile [ 1 - 4 ] user-account [ 1 - 4 ] codec G726\_40 packetization-time [value]**

Assigns a packetization time value to the 40 kbit/s G.726 codec on the user account. Default: **20**

---

**set voip profile [ 1 - 4 ] user-account [ 1 - 4 ] codec AMR priority [ 1 - 7 | none ]**

Assigns a priority value to the Adaptive Multi-Rate (AMR) - Narrowband audio codec on the user account. Default: **none**.

---

---

**set voip profile [ 1 - 4 ] user-account [ 1 - 4 ] codec AMR payload-type [value]**

Assigns a payload value to the AMR codec on the user account. Default: **120**

---

**set voip profile [ 1 - 4 ] user-account [ 1 - 4 ] codec AMR packetization-time [value]**

Assigns a packetization time value to the AMR codec on the user account. Default: **20**

---

**set voip profile [ 1 - 4 ] user-account [ 1 - 4 ] codec AMR\_WB priority [ 1 - 7 | none ]**

Assigns a priority value to the Adaptive Multi-Rate Wideband (AMR-WB) audio codec on the user account. Default: **none**.

---

**set voip profile [ 1 - 4 ] user-account [ 1 - 4 ] codec AMR\_WB payload-type [value]**

Assigns a payload value to the AMR-WB codec on the user account. Default: **122**

---

**set voip profile [ 1 - 4 ] user-account [ 1 - 4 ] codec AMR\_WB packetization-time [value]**

Assigns a packetization time value to the AMR-WB codec on the user account. Default: **20**

---

**set voip profile [ 1 - 4 ] user-account [ 1 - 4 ] call-feature call-forwarding-all-option [ on | off ]**

Turns unconditional call forwarding on or off for the specified user account.

---

**set voip profile [ 1 - 4 ] user-account [ 1 - 4 ] call-feature call-forwarding-on-busy-option [ on | off ]**

Enables or disables call forwarding when the line is busy for the specified user account.

---

**set voip profile [ 1 - 4 ] user-account [ 1 - 4 ] call-feature call-forwarding-on-no-answer-option [ on | off ]**

Turns no-answer call forwarding on or off for the specified user account.

---

**set voip profile [ 1 - 4 ] user-account [ 1 - 4 ] call-feature call-waiting-option [ on | off ]**

Enables or disables call waiting for the specified user account.

---

**set voip profile [ 1 - 4 ] user-account [ 1 - 4 ] call-feature call-conferencing-option [ on | off ]**

Enables or disables 3-way conferencing for the user account.

---

**set voip profile [ 1 - 4 ] user-account [ 1 - 4 ] call-feature do-not-disturb-option [ on | off ]**

Activates or deactivates the ring-prevention (do not disturb) option for the specified user account.

---

**set voip profile [ 1 - 4 ] user-account [ 1 - 4 ] call-feature subscribe-mwi-option [ on | off ]**

Enables or disables the message waiting indicator for the user account.

---

**set voip profile [ 1 - 4 ] user-account [ 1 - 4 ] call-feature subscribe-send-message [ on | off ]**

Enables or disables message sending for the user account.

---

**set voip profile [ 1 - 4 ] user-account [ 1 - 4 ] call-feature anonymous-call-block-option [ on | off ]**

Sets the user account to block (on) or accept (off) calls from unidentified sources.

---

**set voip profile [ 1 - 4 ] user-account [ 1 - 4 ] call-feature call-transfer-option [ on | off ]**

Enables or disables the call transfer function on the user account.

---

**set voip profile [ 1 - 4 ] user-account [ 1 - 4 ] call-feature call-disconn-supervision-option [ on | off ]**

Enables or disables disconnection supervision on the user account.

---

**set voip profile [ 1 - 4 ] user-account [ 1 - 4 ] call-feature call-osi-signaldur [ value ]**

Assigns an OSI signal duration value to the account. Default: **800**.

---

**set voip profile [ 1 - 4 ] user-account [ 1 - 4 ] dsp-settings echo-option [ echo-off | echo-on | echo-on-nlp | echo-on-cng-nlp ]**

Specifies the conditions under which the user account will invoke or disable echo cancellation. Default: **echo-on-cng-nlp**

---

**set voip profile [ 1 - 4 ] user-account [ 1 - 4 ] dsp-settings echo-tail-length 0**

Specifies the length of the Digital Signal Processor (DSP) echo tail in milliseconds. Default: **0**.

---

**set voip profile [ 1 - 4 ] user-account [ 1 - 4 ] dsp-settings vad-option [ on | off ]**

Enables or disables voice activity detection (VAD) in the DSP for the user account.

---

---

## Targeted Ad Insertion Commands

---

### **set targeted-ad-insertion enable [ on | off ]**

Turns targeted ad insertion on or off. Default is **on**.

---

### **set targeted-ad-insertion v-zone-ad [ on | off ]**

Specifies whether the targeted ad is zone-specific. Default is **on**.

---

### **set targeted-ad-insertion sender-ssrc [ 0... n ]**

Specifies the synchronization source identifier for the sender.

---

### **set targeted-ad-insertion carousel-ip-address *ip\_address***

Specifies the IP address of the ad carousel server.

---

### **set targeted-ad-insertion carousel-port [ 0... n ]**

Specifies the port of the ad carousel server.

---

### **set targeted-ad-insertion vcc-group-id [ 0... n ]**

Specifies the VCC group identifier of the ad carousel server.

---

### **set targeted-ad-insertion key-identification-counter [ 0... n ]**

Sets a counter value for the ad key identifier.

---

### **set targeted-ad-insertion authentication-key *string***

Specifies an authentication key for the targeted ads.

---

### **set targeted-ad-insertion channel-change-notification [ on | off ]**

Turns the “change the channel” notification on or off. Default is **on**.

---

### **set targeted-ad-insertion retransmit [ on | off ]**

Turns ad retransmission on or off. Default is **on**.

---

### **set targeted-ad-insertion unicast-filter [ on | off ]**

Turns unicast filtering on or off. Default is **on**.

---

### **set targeted-ad-insertion blocked-unicast-sources *string***

Specifies names of unicast targeted ad sources to be blocked.

---

### **set targeted-ad-insertion hello-interval *seconds***

Specifies an interval for ad insertion in seconds. Default is **7200** (2 hours).

---

---

**set targeted-ad-insertion hello-retransmit-min *seconds***

Specifies a minimum interval for retransmission of ad insertion in seconds. Default is 15 seconds.

---

**set targeted-ad-insertion hello-retransmit-max *seconds***

Specifies a maximum interval for retransmission of ad insertion in seconds. Default is 300 seconds.

---

**set targeted-ad-insertion vcc-ip-address *ip\_address***

Specifies the VCC IP address of the ad carousel server.

---

**set targeted-ad-insertion vcc-port [ 0... n ]**

Specifies the VCC port of the ad carousel server.

---

**set targeted-ad-insertion zones *zone\_number***

Specifies the zone for targeted ads when **v-zone-ad** is set to **on**.

---

**set targeted-ad-insertion during-ad-timeout *value***

Sets a timeout value. Default is 25,000.

---

## System Commands

---

### **set system name *name***

Specifies the name of your NVG599 device. Each NVG599 is assigned a name as part of its factory initialization. The default name for an NVG599 device consists of the word “ARRIS-7000/XXX” where “XXX” is the serial number of the device; for example, ARRIS-7000/9437188. A system name can be 1 – 255 characters long. Once you have assigned a name to your NVG599, you can enter that name in the address text field of your browser to open a connection to your NVG599.



**NOTE:**

Some broadband cable-oriented service providers use the system name as an important identification and support parameter. If your NVG599 device is part of this type of network, do *not* alter the system name unless specifically instructed by your service provider.

---

### **set system time-zone [ UTC | HST10 | AKST9AKDT | YST8 | PST8PDT | MST7MDT | MST7 | CST6CDT | CST6 | EST5EDT | AST4ADT | NST3:30NDT ]**

A **time-zone** setting of 0 is Coordinated Universal Time (UTC); options are -12 through 12 (+/- 1 hour increments from UTC time).

---

### **set system auto-daylight-savings [ on | off ]**

Time zones honoring Daylight Saving Time may be automatically designated.

---

### **set system firewall-log enable [ on | off ]**

Turns firewall logging on or off. The firewall log tracks attempted violations of the firewall rules. Default is **on**.

---

### **set system firewall-log persist [ on | off ]**

When set to **on**, causes the log information to be kept in flash memory. Default is **off**.

---

### **set system firewall-log file-size [ 4096... 65536 ]**

Specifies a size for the firewall logs. The most recent entries are posted to the beginning of the log. When the log becomes full, the oldest entries are dropped. The default is **16384**.

---

### **set system firewall-log file-count [ 2... 8 ]**

Specifies the number of possible log files. The default is **4**.

---

### **set system fastpath software-enable [ on | off ]**

Enables or disables the fastpath accelerator processor. Fastpath works on only TCP and UDP. Default is **on**.

---

### **set system fastpath hardware-enable [ off | on ]**

Enables or disables the fastpath accelerator processor. Default is **off**.

---

### **set system fastpath mcast-mode 3**

Sets the mode for multicast on the fastpath accelerator processor.

---

### **set system scheduler enable [ off | on ]**

Turns the system scheduler feature on or off. The default is **off**.

---

### **set system scheduler enable-time *hr:min***

Specifies a time at which to turn the system on. Default is midnight (00:00). The **enable-time** parameter must be supplied in 24-hour military time, colon separated, for example "05:21".

---

### **set system scheduler disable-time *hr:min***

Specifies a time at which to turn the system off. Default is 5 o'clock (05:00). The **disable-time** parameter must be supplied in 24-hour military time, colon separated, for example "21:44".

---

### **set system calendar-update enable [ on | off ]**

Turns the calendar update feature on or off. The device will periodically poll the update server for new operating system software. The default is **on**.

---

### **set system calendar-update interval [ monthly | biweekly ]**

Specifies how often the device should poll the update server, monthly or biweekly. The default is **monthly**.

---

### **set system calendar-update protocol [ http | https | tftp ]**

Specifies the protocol for accessing the update server. The default is **http**.

---

### **set system calendar-update server *server\_address***

Specifies the address of the update server by name or IP address. The default is "cpems.bellsouth.net".

---

### **set system calendar-update username *string***

Specifies the user name for the update server. The default is **anonymous**.

---

### **set system calendar-update password *string***

Specifies the password for the update server. The default is **guest**.

---

### **set system calendar-update fwverfile *filename***

Specifies the firmware version filename to the update server. For the AT&T NVG599 the file is **netopiaNVG599\_64.txt**.

---

### **set system calendar-update day *day\_of\_month***

Specifies the numerical day of the month for the update server to be polled, for example, **21**.

---

### **set system calendar-update time *hr:min\_AMP***

Specifies the time of day for the update server to be polled, in the format HOUR:MINUTEAM/PM. For example: **06:00AM**.

---

---

## set system supplicant enable [ on | off ]

Turns on the 802.1x supplicant functionality. You must set the corresponding **type** field in the WAN link to activate it:

```
NOS/142253966608 (top)>> set link name WAN supplicant
supplicant
  type (none) [ none | eap-tls ]:
  priority (0) [ 0 - 7 ]:
```

Default is **on**.

---

## set system supplicant dest-broadcast [ off | on ]

Mostly useful for debugging. If this is set to **on**, the destination MAC address FF:FF:FF:FF:FF:FF is used when the supplicant sends 802.1x packets. If this is **off**, the EAPOL-specific destination address of 01:80:C2:00:00:03 is used. Default is **off**.

---

## set system supplicant eap-tls-identity *string*

Sets the identity sent by the supplicant in response to an Identity request from an 802.1x authenticator.

---

## set system supplicant server-cert-check [ on | off ]

If set to **on**, examines the certificate chain sent by an 802.1x authenticator for validation, and ensures that the root cert of this chain is accepted by the CPE (is in its trust list). Default is **on**.

---

## set system syslog enable [ on | off ]

Enables or disables the NVG599 Syslog function. The Syslog function is disabled by default. If Syslog is enabled, the following additional Syslog settings may be configured:

- ◆ [set system syslog server-ip <IPv4/IPv6 Address>](#)
- ◆ [set system syslog server-port <port>](#)
- ◆ [set system syslog facility \[ local0 ... local7 \]](#)
- ◆ [set system syslog level \[ 0 ... 7 \]](#)
- ◆ [set system syslog log-system \[ on | off \]](#)
- ◆ [set system syslog log-firewall \[ on | off \]](#)
- ◆ [set system syslog log-igmp \[ on | off \]](#)
- ◆ [set system syslog log-voice \[ on | off \]](#)

You must specify the Syslog server's IP address and any custom UDP port number to identify system logging messages with the [set system syslog server-ip <IPv4/IPv6 Address>](#) and [set system syslog server-port <port>](#) commands. After the Syslog server is specified, you may turn on any or all of the logging categories.

The receiving server must have a properly configured Syslog server package active.

---

## set system syslog server-ip <IPv4/IPv6 Address>

Specifies the IP address (in IPv4 dotted decimal notation or IPv6 colon-separated hexadecimal notation) of the server that Syslog messages will be sent to.

---

## set system syslog server-port <port>

Customizes the UDP port number that the Syslog function marks messages to the logging server package with (range: 1 - 65535, default: **514**).



---

### **set system syslog facility [ local0 ... local7 ]**

Specifies the local facility number that Syslog messages are sent to (range: local0 - local7, default: **local0**).

---

### **set system syslog level [ 0 ... 7 ]**

Sets the severity level of Syslog messages the NVG599 will send to the Syslog server. Each severity level includes all higher-level messages (e.g; a level of 2 [Critical] will also send Alert and Emergency messages). The severity levels are arranged and enumerated as follows:

- ◆ 0 : Emergency
  - ◆ 1 : Alert
  - ◆ 2 : Critical
  - ◆ 3 : Error
  - ◆ 4 : Warning
  - ◆ 5 : Notice (default)
  - ◆ 6 : Info
  - ◆ 7 : Debug
- 

### **set system syslog log-system [ on | off ]**

Enables or disables the generation of system log messages for the Syslog server. If the Syslog function is enabled, system log is enabled (on) by default.

---

### **set system syslog log-firewall [ on | off ]**

Enables or disables the delivery of firewall log messages to the Syslog server. Firewall log is disabled by default.

---

### **set system syslog log-igmp [ on | off ]**

Enables or disables the delivery of IGMP log messages to the Syslog server. The IGMP log is disabled by default.

---

### **set system syslog log-voice [ on | off ]**

Enables or disables the generation of voice log messages for the Syslog server. Voice log is disabled by default.

---

### **set system voice-check enable [ off | on ]**

When this is set to **on**, and a voice call is in progress when a software update is scheduled, the software update is deferred for the **voice-check interval** until the call is completed, that is, the call state becomes "idle." If set to **off**, and a voice call is in progress when an update is scheduled, the call is torn down. The default is **on**.

---

### **set system voice-check interval [ 60 - 86400 ]**

Specifies the interval in seconds for the device to wait before attempting a software update, when a software update is scheduled but a voice call is in progress, when **voice-check enable** is set to **on**. The default is **300** (5 minutes).

---

### **set system voice-check max-time [ 300 - 604800 ]**

Specifies the maximum time in seconds for the device to continue to attempt a scheduled software update if a voice call is in progress and **voice-check enable** is set to **on**. The default is **3600** (1 hour).

---

---

---

## set system log buffer-size [ 4096... 65536 ]

Specifies a size for the system log. The most recent entries are posted to the beginning of the log. When the log becomes full, the oldest entries are dropped. The default is **16384**.

---

---

## set system log level [ low | medium | high | alerts | failures ]

Specifies the types of log messages you want the NVG599 device to record. All messages with a level equal to or greater than the level you specify are recorded. For example, if you specify set system diagnostic-level **medium**, the diagnostic log will retain medium-level informational messages, alerts, and failure messages.

Use the following guidelines:

- ◆ **low** - Low-level informational messages or greater; includes trivial status messages.
- ◆ **medium** - Medium-level informational messages or greater; includes status messages that can help monitor network traffic.
- ◆ **high** - High-level informational messages or greater; includes status messages that may be significant but do not constitute errors. The default.
- ◆ **alerts** - Warnings or greater; includes recoverable error conditions and useful operator information.
- ◆ **failures** - Failures; includes messages describing error conditions that may not be recoverable.

## Debug Commands

When you are in SHELL mode, the Debug prompt consists of the name of the NVG599 device followed by the word "DEBUG" and a right angle bracket (>). For example, if you open a CLI connection to the NVG599 named "ARRIS-3000/9437188" and then type **debug** you would see **ARRIS-3000/9437188/DEBUG>** as your prompt.

Debug level is available for field debugging purposes. There is no service and quality level guarantee from ARRIS. This level is intended for SEs or Telco lab personnel, not for normal operation at home for end users.

More commands are available. To display the options, type **help all**.

## Disclaimer and Warning Text

The following is displayed when entering Debug level from normal Config level.

**"Warning: Accessing these commands may impact the normal operation of this device. Exit now if you entered by mistake."**

## Commands

---

### console

Makes this session the console.

---

### mirror <src-port> <dst-port>

Mirrors one port's traffic to another. Causes traffic transmitted or received on <src-port> to be mirrored on <dst-port>. Ports must support Ethernet (IPoA and PPPoA ATM ports are not supported).

---

### mirror off

Turns off port mirroring.

---

### show fastpath

Displays entries in fastpath.

---

### show cpu

Displays CPU usage as a percentage and CPU load averages over 1, 5, and 15 minute periods.

## TR-069 CLI CShell Commands (debug mode)

```
tr69 GetParameterValues <path>
tr69 SetParameterValues <path> = <value>
tr69 GetParameterNames <path> <nextlevel>
tr69 Addobject <path>
tr69 Deleteobject <path>
```

### Example:

```
tr69 GetParameterValues InternetGatewayDevice.
```

---



#### NOTE:

CLI and ACS sessions are mutually exclusive and should not be used at the same time

---

---

## Description

**Dimensions:**

9.8 in H x 7.9 in L x 2.8 in W (250 mm H x 200 mm L x 77 mm W)

1.97 lbs (.89 kg) (without integrated battery)

2.47 lbs (1 kg) (with integrated battery)

**Communications interfaces:** The ARRIS Gateways have a 4-port 10/100/1000Base-T Ethernet switch for your LAN connections, an FXS port for VoIP connections, a HomePNA 3.1 coax port, a USB 2.0 network port, and a 400 mW wireless radio for Wi-Fi connections.

**WAN interfaces:** Bonded VDSL2/single line VDSL2/bonded ADSL2+/single line ADSL, RJ-14; One-port 10/100/1000 Ethernet, RJ-45

## Power Supply

115VAC 42W/12VDC@3.5A (2phone,5REN, RINGING)

## Environment

**Operating temperature:** 0°C to 42°C (32° F to 107° F); 8% to 95% (Non Condensing) Relative Humidity

**Storage temperature:** -20° C to 85° C (-4° F to 185° F)

**Relative storage humidity:** 20 to 80% non-condensing

## Software and protocols

**Software media:** Software preloaded on internal flash memory; field upgrades done via download to internal flash memory via CLI or web upload.

**Routing:** IPv4 , IPv6/6rd; DHCP server/relay; DNS Proxy, Dynamic DNS Support; Multiple subnet support

**WAN support:** PPPoA, DHCP, static IP address; ADSL, ADSL2/2+, ADSL2 Reach Extended protocol (ITU G.992.3 annex L)

**Security:** Stateful Packet Inspection Firewall; Virtual DMZ/IP pass-through; Denial of Service (DoS) protection; VPN Pass-through (PPTP, L2TP, IPSec)

**Wi-Fi Security.** WEP (64-bit, 128-bit, 256-bit) encryption 802.1x, WPA, WPA-PSK, 802.11i/WPA2, WPA2-PSK EAP-TLS, EAP-TTLS, EAP-SIM MAC Address filtering

**Management/configuration methods:** HTTP (Web server), telnet command line interface

**Diagnostics:** Ping, event logging, routing table displays, statistics counters, web-based management, traceroute, nslookup, and diagnostic commands.

## Agency approvals

### North America

Safety Approvals:

- ◆ United States – UL 60950, Third Edition
- ◆ Canada – CSA: CAN/CSA-C22.2 No. 60950-00

EMC:

- ◆ United States – FCC Part 15 Class B
- ◆ Canada – ICES-003

Telecom:

- ◆ United States – 47 CFR Part 68
- ◆ Canada – CS-03

Integrated Battery:

- ◆ Hazardous Materials Regulations and Procedures CFR Title 49, Section 173, Subsection 185
- ◆ UL60950/CAN/CSA-C22.2 No. 60950—Recognized component (U.S. and Canada)
- ◆ UL 2054—Recognized component (U.S. and Canada)
- ◆ UN Manual of test and Criteria, sect. 38.3, CE, IEC62133
- ◆ California Code of Regulation Title 20

---

## Manufacturer's Declaration of Conformance

---

**WARNING:**

This is a Class B product. In a domestic environment this product may cause radio interference, in which case the user may be required to take adequate measures. Adequate measures include increasing the physical distance between this product and other electrical devices.

Changes or modifications to this unit not expressly approved by the party responsible for compliance could void the user's authority to operate the equipment.

---

**United States.** This device complies with Part 15 of the FCC Rules. Operation is subject to the following two conditions:

1. This device may not cause harmful interference, and
2. this device must accept any interference received, including interference that may cause undesired operation.

This equipment has been tested and found to comply with the limits for a Class B digital device, pursuant to Part 15 of the FCC Rules. These limits are designed to provide reasonable protection against harmful interference in a residential installation. This equipment generates, uses, and can radiate radio frequency energy and, if not installed and used in accordance with the instructions, may cause harmful interference to radio communications. However, there is no guarantee that interference will not occur in a particular installation. If this equipment does cause harmful interference to radio or television reception, which can be determined by turning the equipment off and on, the user is encouraged to try to correct the interference by one or more of the following measures:

- ◆ Reorient or relocate the device.
- ◆ Increase the distance between the equipment being interfered with and the device.
- ◆ Connect the device to an outlet on a circuit different from the outlet to which the equipment being interfered with is connected.
- ◆ Consult the retailer or an experienced radio/TV technician for help.

**FCC Caution:** Any changes or modifications not expressly approved by the party responsible for compliance could void the user's authority to operate this equipment.

This transmitter must not be co-located or operating in conjunction with any other antenna or transmitter.

- ◆ Operations within the 5.15 ~ 5.25GHz band are restricted to indoor use only. This device is intended for indoor use only.
- 

**RESTRICTIONS:**

- ◆ Do not install this device out doors.
- ◆ This device is restricted from transmitting in the 5600-5650 MHz band.

**WARNING:**

- ◆ Installing and operating this device out doors is a violation of FCC rules.
- 

**Radiation Exposure Statement:** This equipment complies with FCC radiation exposure limits as set forth for an uncontrolled environment. This equipment should be installed and operated maintaining a minimum distance of 20cm between the device and your body.

**Service requirements.** In the event of equipment malfunction, if under warranty we will exchange a product deemed defective. Under FCC rules, no customer is authorized to repair this equipment. This restriction applies regardless of whether the equipment is in or out of warranty.

Technical Support for Hardware Products

1-877-466-8646

<http://www.arrisi.com/consumer>



**IMPORTANT:**

This product was tested for FCC compliance under conditions that included the use of shielded cables and connectors between system components. Changes or modifications to this product not authorized by the manufacturer could void your authority to operate the equipment.

---

**Canada.** This Class B digital apparatus meets all requirements of the Canadian Interference -Causing Equipment Regulations.

Cet appareil numérique de la classe B respecte toutes les exigences du Règlement sur le matériel brouilleur du Canada.

### Declaration for Canadian users

**NOTICE:** The Canadian Industry Canada label identifies certified equipment. This certification means that the equipment meets certain telecommunications network protective, operation, and safety requirements. The Department does not guarantee the equipment will operate to the user's satisfaction.

Before installing this equipment, users should ensure that it is permissible to be connected to the facilities of the local telecommunications company. The equipment must also be installed using an acceptable method of connection. In some cases, the company's inside wiring associated with a single line individual service may be extended by means of a certified connector assembly (telephone extension cord). The customer should be aware that compliance with the above conditions may not prevent degradation of service in some situations.

Repairs to the certified equipment should be made by an authorized Canadian maintenance facility designated by the supplier. Any repairs or alterations made by the user to this equipment, or equipment malfunctions, may give the telecommunications company cause to request the user to disconnect the equipment.

Users should ensure for their own protection that the electrical ground connections of the power utility, telephone lines, and internal metallic water pipe system, if present, are connected together. This precaution may be particularly important in rural areas.

**NOTICE:** This equipment meets the applicable Industry Canada Terminal Equipment Technical Specifications. This is confirmed by the registration number. The abbreviation, IC, before the registration number signifies that registration was performed based on a Declaration of Conformity indicating that Industry Canada technical specifications were met. It does not imply that Industry Canada approved the equipment.

**AVIS :** Le présent matériel est conforme aux spécifications techniques d'Industrie Canada applicables au matériel terminal. Cette conformité est confirmée par le numéro d'enregistrement. Le sigle IC, placé devant le numéro d'enregistrement, signifie que l'enregistrement s'est effectué conformément à une déclaration de conformité et indique que les spécifications techniques d'Industrie Canada ont été respectées. Il n'implique pas qu'Industrie Canada a approuvé le matériel.

### Caution

Users should not attempt to make such connections themselves, but should contact the appropriate electric inspection authority, or electrician, as appropriate.

**NOTICE:** The Ringer Equivalence Number (REN) for this terminal equipment is **0.1**. The REN assigned to each terminal equipment provides an indication of the maximum number of terminals allowed to be connected to a



---

telephone interface. The termination on an interface may consist of any combination of devices subject only to the requirement that the sum of the Ringer Equivalence Numbers of all the devices does not exceed five.

AVIS : L'indice d'équivalence de la sonnerie (IES) du présent matériel est de **0.1**. L'IES assigné à chaque dispositif terminal indique le nombre maximal de terminaux qui peuvent être raccordés à une interface téléphonique. La terminaison d'une interface peut consister en une combinaison quelconque de dispositifs, à la seule condition que la somme d'indices d'équivalence de la sonnerie de tous les dispositifs n'excède pas 5.

## Important Safety Instructions

### Caution

**DO NOT USE BEFORE READING THE INSTRUCTIONS:** Do not connect the Ethernet ports to a carrier or carriage service provider's telecommunications network or facility unless: a) you have the written consent of the network or facility manager, or b) the connection is in accordance with a connection permit or connection rules.

Connection of the Ethernet ports may cause a hazard or damage to the telecommunication network or facility, or persons, with consequential liability for substantial compensation.

### Caution

- ◆ The direct plug-in power supply serves as the main power disconnect; locate the direct plug-in power supply near the product for easy access.
- ◆ For use only with CSA Certified Class 2 power supply, rated 12VDC, 1.0A.

### Telecommunication installation cautions

- ◆ Never install telephone wiring during a lightning storm.
- ◆ Never install telephone jacks in wet locations unless the jack is specifically designed for wet locations.
- ◆ Never touch uninsulated telephone wires or terminals unless the telephone line has been disconnected at the network interface.
- ◆ Use caution when installing or modifying telephone lines.
- ◆ Avoid using a telephone (other than a cordless type) during an electrical storm. There may be a remote risk of electric shock from lightning.
- ◆ Do not use the telephone to report a gas leak in the vicinity of the leak.

## 47 CFR Part 68 Information

### FCC Requirements

1. The Federal Communications Commission (FCC) has established Rules which permit this device to be directly connected to the telephone network. Standardized jacks are used for these connections. This equipment should not be used on party lines or coin phones.
2. If this device is malfunctioning, it may also be causing harm to the telephone network; this device should be disconnected until the source of the problem can be determined and until repair has been made. If this is not done, the telephone company may temporarily disconnect service.
3. The telephone company may make changes in its technical operations and procedures; if such changes affect the compatibility or use of this device, the telephone company is required to give adequate notice of the changes. You will be advised of your right to file a complaint with the FCC.
4. If the telephone company requests information on what equipment is connected to their lines, inform them of:
  - a. The telephone number to which this unit is connected.
  - b. The ringer equivalence number. [0.XB]
  - c. The USOC jack required. [RJ11C]
  - d. The FCC Registration Number. [XXXUSA-XXXXX-XX-E]

Items (b) and (d) are indicated on the label. The Ringer Equivalence Number (REN) is used to determine how many devices can be connected to your telephone line. In most areas, the sum of the REN's of all devices on any one line should not exceed five (5.0). If too many devices are attached, they may not ring properly.

### FCC Statements

- a) This equipment complies with Part 68 of the FCC rules and the requirements adopted by the ACTA. On the bottom of this equipment is a label that contains, among other information, a product identifier in the format US:AAAEQ##TXXXX. If requested, this number must be provided to the telephone company.
- b) List all applicable certification jack Universal Service Order Codes ("USOC") for the equipment: RJ11.
- c) A plug and jack used to connect this equipment to the premises wiring and telephone network must comply with the applicable FCC Part 68 rules and requirements adopted by the ACTA. A compliant telephone cord and modular plug is provided with this product. It is designed to be connected to a compatible modular jack that is also compliant. See installation instructions for details.
- d) The REN is used to determine the number of devices that may be connected to a telephone line. Excessive RENs on a telephone line may result in the devices not ringing in response to an incoming call. In most but not all areas, the sum of RENs should not exceed five (5.0). To be certain of the number of devices that may be connected to a line, as determined by the total RENs, contact the local telephone company. For products approved after July 23, 2002, the REN for this product is part of the product identifier that has the format US:AAAEQ##TXXXX. The digits represented by ## are the REN without a decimal point (e.g., 03 is a REN of 0.3). For earlier products, the REN is separately shown on the label.
- e) If this equipment, the NVG599 device, causes harm to the telephone network, the telephone company will notify you in advance that temporary discontinuance of service may be required. But if advance notice isn't practical, the telephone company will notify the customer as soon as possible. Also, you will be advised of your right to file a complaint with the FCC if you believe it is necessary.
- f) The telephone company may make changes in its facilities, equipment, operations or procedures that could affect the operation of the equipment. If this happens the telephone company will provide advance notice in order for you to make necessary modifications to maintain uninterrupted service.
- g) If trouble is experienced with this equipment, the NVG599 device, for warranty information, please contact:

---

Technical Support for Hardware Products  
1-877-466-8646  
<http://moto.force.com/customercare360>

If the equipment is causing harm to the telephone network, the telephone company may request that you disconnect the equipment until the problem is resolved.

h) This equipment not intended to be repaired by the end user. In case of any problems, please refer to the troubleshooting section of the Product User Manual before calling ARRIS Technical Support.

i) Connection to party line service is subject to state tariffs. Contact the state public utility commission, public service commission or corporation commission for information.

j) If your home has specially wired alarm equipment connected to the telephone line, ensure that the installation of this ARRIS NVG599 VDSL2 Gateway does not disable your alarm equipment. If you have questions about what will disable alarm equipment, consult your telephone company or qualified installer.

## RF Exposure Statement:

**NOTE:** Installation of the wireless models must maintain at least 20 cm between the wireless NVG599 device and any body part of the user to be in compliance with FCC RF exposure guidelines.

## Electrical Safety Advisory

Telephone companies report that electrical surges, typically lightning transients, are very destructive to customer terminal equipment connected to AC power sources. This has been identified as a major nationwide problem. Therefore it is advised that this equipment be connected to AC power through the use of a surge arrester or similar protection device.

## Caring for the Environment by Recycling

When you see this symbol on an ARRIS product, do not dispose of the product with residential or commercial waste.



### Recycling your ARRIS Equipment

Please do not dispose of this product with your residential or commercial waste. Some countries or regions, such as the European Union, have set up systems to collect and recycle electrical and electronic waste items. Contact your local authorities for information about practices established for your region. If collection systems are not available, call ARRIS Customer Service for assistance.

### Beskyttelse af miljøet med genbrug

Når du ser dette symbol på et ARRIS-produkt, må produktet ikke bortskaffes sammen med husholdningsaffald eller erhvervsaffald.

### Genbrug af dit ARRIS-udstyr

Dette produkt må ikke bortskaffes sammen med husholdningsaffald eller erhvervsaffald. Nogle lande eller områder, f.eks. EU, har oprettet systemer til indsamling og genbrug af elektriske og elektroniske affaldsprodukter. Kontakt de lokale myndigheder for oplysninger om gældende fremgangsmåder i dit område. Hvis der ikke findes tilgængelige indsamlingssystemer, kan du kontakte ARRIS Kundeservice.

### Umweltschutz durch Recycling

Wenn Sie dieses Zeichen auf einem Produkt von ARRIS sehen, entsorgen Sie das Produkt bitte nicht als gewöhnlichen Hausoder Büromüll.

### Recycling bei Geräten von ARRIS

Bitte entsorgen Sie dieses Produkt nicht als gewöhnlichen Haus- oder Büromüll. In einigen Ländern und Gebieten, z. B. in der Europäischen Union, wurden Systeme für die Rücknahme und Wiederverwertung von Elektroschrott eingeführt. Erkundigen Sie sich bitte bei Ihrer Stadtober Kreisverwaltung nach der geltenden Entsorgungspraxis. Falls bei Ihnen noch kein Abfuhr- oder Rücknahmesystem besteht, wenden Sie sich bitte an den Kundendienst von ARRIS.

### Cuidar el medio ambiente mediante el reciclaje

Cuando vea este símbolo en un producto ARRIS, no lo deseche junto con residuos residenciales o comerciales.

### Reciclaje de su equipo ARRIS

No deseche este producto junto con sus residuos residenciales o comerciales. Algunos países o regiones, tales como la Unión Europea, han organizado sistemas para recoger y reciclar desechos eléctricos y electrónicos. Comuníquese con las autoridades locales para obtener información acerca de las prácticas vigentes en su región. Si no existen sistemas de recolección disponibles, solicite asistencia llamando el Servicio al Cliente de ARRIS.

### Recyclage pour le respect de l'environnement

Lorsque vous voyez ce symbole sur un produit ARRIS, ne le jetez pas avec vos ordures ménagères ou vos rejets d'entreprise.

### Recyclage de votre équipement ARRIS

Veillez ne pas jeter ce produit avec vos ordures ménagères ou vos rejets d'entreprise. Certains pays ou certaines régions comme l'Union Européenne ont mis en place des systèmes de collecte et de recyclage des produits électriques et électroniques mis au rebut. Veuillez contacter vos autorités locales pour vous informer des pratiques instaurées dans votre région. Si aucun système de collecte n'est disponible, veuillez appeler le Service clientèle de ARRIS qui vous apportera son assistance.

---

## Milieubewust recycleren

Als u dit symbool op een ARRIS-product ziet, gooi het dan niet bij het huishoudelijk afval of het bedrijfsafval.

## Dbá³oEç o Erodowisko - recykling

Produktów ARRIS oznaczonych tym symbolem nie nale y wyrzucaç do komunalnych pojemników na Êmieci.

## Cuidando do meio ambiente através da reciclagem

Quando você ver este símbolo em um produto ARRIS, não descarte o produto junto com lixo residencial ou comercial.

## Var rädd om miljön genom återvinning

När du ser den här symbolen på en av ARRIS produkter ska du inte kasta produkten tillsammans med det vanliga avfallet.

## リサイクルによる環境保護

モトローラ製品にこの記号が表示されている場合、製品を家庭または商業廃棄物として処分しないでください。

## リサイクルによる環境保護

モトローラ製品にこの記号が表示されている場合、製品を家庭または商業廃棄物として処分しないでください。

## Uw ARRIS-materiaal recycleren.

Gooi dit product niet bij het huishoudelijk afval het of bedrijfsafval. In sommige landen of regio's zoals de Europese Unie, zijn er bepaalde systemen om elektrische of elektronische afvalproducten in te zamelen en te recycleren. Neem contact op met de plaatselijke overheid voor informatie over de geldende regels in uw regio. Indien er geen systemen bestaan, neemt u contact op met de klantendienst van ARRIS.

## Recykling posiadanego sprz³tu ARRIS

Produktu nie nale y wyrzucaç do komunalnych pojemników na Êmieci. W niektórych krajach i regionach, np. w Unii Europejskiej, istniejà systemy zbierania i recyklingu sprz³tu elektrycznego i elektronicznego. Informacje o utylizacji tego rodzaju odpadów nale y uzyskaç od w³adz lokalnych. JeÊli w danym regionie nie istniejà systemy zbierania odpadów elektrycznych i elektronicznych, informacje o utylizacji nale y uzyskaç od biura obs³ugi klienta firmy ARRIS (ARRIS Customer Service).

## Reciclagem do seu equipamento ARRIS

Não descarte este produto junto com o lixo residencial ou comercial. Alguns países ou regiões, tais como a União Européia, criaram sistemas para coleccionar e reciclar produtos eletroeletrônicos. Para obter informações sobre as práticas estabelecidas para sua região, entre em contato com as autoridades locais. Se não houver sistemas de coleta disponíveis, entre em contato com o Serviço ao Cliente da ARRIS para obter assistência.

## Återvinning av din ARRIS-utrustning

Kasta inte denna produkt tillsammans med det vanliga avfallet. Vissa länder eller regioner, som t.ex. EU, har satt upp ett system för insamling och återvinning av el- och elektronikavfall. Kontakta dina lokala myndigheter för information om vilka regler som gäller i din region. Om det inte finns något insamlingsssystem ska du kontakta ARRIS kundtjänst för hjälp.

## モトローラ装置のリサイクル

本製品を家庭または商業廃棄物として処分しないでください。欧州連合などの国または地域によっては、電氣的・電子的廃棄物を収集およびリサイクルするシステムがあります。お住まいの地域で決められている方法についての情報は、地方自治体にお問い合わせください。収集システムがない場合、モトローラ・カスタマーサービスまでお問い合わせください。

## モトローラ装置のリサイクル

本製品を家庭または商業廃棄物として処分しないでください。欧州連合などの国または地域によっては、電氣的・電子的廃棄物を収集およびリサイクルするシステムがあります。お住まいの地域で決められている方法についての情報は、地方自治体にお問い合わせください。収集システムがない場合、モトローラ・カスタマーサービスまでお問い合わせください。

**재활용으로 환경 보호하기**

ARRIS 제품에 이 표시가 있는 경우, 가정 또는 상업 폐기물과 함께 버리지 마십시오.

**ARRIS 기기 재활용**

이 제품을 가정용 또는 상업용 폐기물과 함께 버리지 마십시오. 유럽 유니온과 같은 일부 국가 또는 지역에서는 재활용 전기 전자 폐기물 할당을 추적하는 시스템이 구축되어 있습니다. 해당 지역에 구축되어 있는 절차에 관한 정보는 지역 관할당국에 연락하십시오. 수집 시스템이 존재하지 않는 경우, 도움을 받기 위해 Motorola 고객서비스부로 연락하십시오.

**注意環保問題**

在你看到產品上有!ARRIS 的標誌時，請勿以住家或商用的廢棄物方式處置。

**ARRIS 設備的回收**

請勿以住家或商用的廢棄物方式處置。某些國家或地區，如歐盟，已對廢棄的電器和電子產品制訂回收以及再利用體制。請與您所在地的管理機構諮詢相關規定。  
若您所在的地區並未設置回收機制，請電Motorola客服部諮詢相關事宜。

---

## Copyright Acknowledgments

Because ARRIS Group, Inc. has included certain software source code in this product, ARRIS includes the following text required by the respective copyright holders:

### Open Source Software Information

For instructions on how to obtain a copy of any source code being made publicly available by ARRIS related to software used in this ARRIS product you may send your request in writing to:

ARRIS Group, Inc.  
OSS Management  
2450 Walsh Avenue  
Santa Clara, CA 95051  
USA

The ARRIS website [opensource.arrisi.com](http://opensource.arrisi.com) also contains information regarding ARRIS's use of open source. ARRIS has created the [opensource.arrisi.com](http://opensource.arrisi.com) to serve as a portal for interaction with the software community-at-large.

This document contains additional information regarding licenses, acknowledgments and required copyright notices for open source packages used in this ARRIS product.

### aiccu 2007.01.15

The SixXS License - <http://www.sixxs.net/>

Copyright (C) SixXS <[info@sixxs.net](mailto:info@sixxs.net)>  
All rights reserved.

Redistribution and use in source and binary forms, with or without modification, are permitted provided that the following conditions are met:

1. Redistributions of source code must retain the above copyright notice, this list of conditions and the following disclaimer.
2. Redistributions in binary form must reproduce the above copyright notice, this list of conditions and the following disclaimer in the documentation and/or other materials provided with the distribution.
3. Neither the name of SixXS nor the names of its contributors may be used to endorse or promote products derived from this software without specific prior permission.

THIS SOFTWARE IS PROVIDED BY SIXXS AND CONTRIBUTORS ``AS IS'' AND ANY EXPRESS OR IMPLIED WARRANTIES, INCLUDING, BUT NOT LIMITED TO, THE IMPLIED WARRANTIES OF MERCHANTABILITY AND FITNESS FOR A PARTICULAR PURPOSE ARE DISCLAIMED. IN NO EVENT SHALL SIXXS OR CONTRIBUTORS BE LIABLE FOR ANY DIRECT, INDIRECT, INCIDENTAL, SPECIAL, EXEMPLARY, OR CONSEQUENTIAL DAMAGES (INCLUDING, BUT NOT LIMITED TO, PROCUREMENT OF SUBSTITUTE GOODS OR SERVICES; LOSS OF USE, DATA, OR PROFITS; OR BUSINESS INTERRUPTION) HOWEVER CAUSED AND ON ANY THEORY OF LIABILITY, WHETHER IN CONTRACT, STRICT LIABILITY, OR TORT (INCLUDING NEGLIGENCE OR OTHERWISE) ARISING IN ANY WAY OUT OF THE USE OF THIS SOFTWARE, EVEN IF ADVISED OF THE POSSIBILITY OF SUCH DAMAGE.

### ASN.1 object dumping code

Copyright (c) Peter Gutmann

### c-ares async resolver library

<http://daniel.haxx.se/projects/c-ares/>

### Original ares library by Greg Hudson, MIT

<ftp://athena-dist.mit.edu/pub/ATHENA/ares>

Copyright 1998 by the Massachusetts Institute of Technology.

Permission to use, copy, modify, and distribute this software and its documentation for any purpose and without fee is hereby granted, provided that the above copyright notice appear in all copies and that both that copyright notice and this permission notice appear in supporting documentation, and that the name of M.I.T. not be used in advertising or publicity pertaining to distribution of the software without specific, written prior permission. M.I.T. makes no representations about the suitability of this software for any purpose. It is provided "as is" without express or implied warranty.

### dhcpcd - DHCP client daemon 5.5.0

Copyright (c) 2006-2010 Roy Marples <roy@marples.name>  
All rights reserved

Redistribution and use in source and binary forms, with or without modification, are permitted provided that the following conditions are met:

1. Redistributions of source code must retain the above copyright notice, this list of conditions and the following disclaimer.
2. Redistributions in binary form must reproduce the above copyright notice, this list of conditions and the following disclaimer in the documentation and/or other materials provided with the distribution.

THIS SOFTWARE IS PROVIDED BY THE AUTHOR AND CONTRIBUTORS ``AS IS'' AND ANY EXPRESS OR IMPLIED WARRANTIES, INCLUDING, BUT NOT LIMITED TO, THE IMPLIED WARRANTIES OF MERCHANTABILITY AND FITNESS FOR A PARTICULAR PURPOSE ARE DISCLAIMED. IN NO EVENT SHALL THE AUTHOR OR CONTRIBUTORS BE LIABLE FOR ANY DIRECT, INDIRECT, INCIDENTAL, SPECIAL, EXEMPLARY, OR CONSEQUENTIAL DAMAGES (INCLUDING, BUT NOT LIMITED TO, PROCUREMENT OF SUBSTITUTE GOODS OR SERVICES; LOSS OF USE, DATA, OR PROFITS; OR BUSINESS INTERRUPTION) HOWEVER CAUSED AND ON ANY THEORY OF LIABILITY, WHETHER IN CONTRACT, STRICT LIABILITY, OR TORT (INCLUDING NEGLIGENCE OR OTHERWISE) ARISING IN ANY WAY OUT OF THE USE OF THIS SOFTWARE, EVEN IF ADVISED OF THE POSSIBILITY OF SUCH DAMAGE.

Copyright (c) ARRIS India Electronics

### dhcp (dhcp-isc) 4.1.1-P1

Copyright © 2004-2011 by Internet Systems Consortium, Inc. ("ISC")

Copyright © 1995-2003 by Internet Software Consortium

Permission to use, copy, modify, and/or distribute this software for any purpose with or without fee is hereby granted, provided that the above copyright notice and this permission notice appear in all copies.

THE SOFTWARE IS PROVIDED "AS IS" AND ISC DISCLAIMS ALL WARRANTIES WITH REGARD TO THIS SOFTWARE INCLUDING ALL IMPLIED WARRANTIES OF MERCHANTABILITY AND FITNESS. IN NO EVENT SHALL ISC BE LIABLE FOR ANY SPECIAL, DIRECT, INDIRECT, OR CONSEQUENTIAL DAMAGES OR ANY DAMAGES WHATSOEVER RESULTING FROM LOSS OF USE, DATA OR PROFITS, WHETHER IN AN ACTION OF CONTRACT, NEGLIGENCE OR OTHER TORTIOUS ACTION, ARISING OUT OF OR IN CONNECTION WITH THE USE OR PERFORMANCE OF THIS SOFTWARE.

### dhcpcd - DHCP client daemon 5.5.0

Copyright (c) 2006-2011 Roy Marples <roy@marples.name>  
All rights reserved

Redistribution and use in source and binary forms, with or without modification, are permitted provided that the following conditions are met:

1. Redistributions of source code must retain the above copyright notice, this list of conditions and the following disclaimer.
2. Redistributions in binary form must reproduce the above copyright notice, this list of conditions and the following disclaimer in the documentation and/or other materials provided with the distribution.

THIS SOFTWARE IS PROVIDED BY THE AUTHOR AND CONTRIBUTORS ``AS IS'' AND ANY EXPRESS OR IMPLIED WARRANTIES, INCLUDING, BUT NOT LIMITED TO, THE IMPLIED WARRANTIES OF MERCHANTABILITY AND FITNESS FOR A PARTICULAR PURPOSE ARE DISCLAIMED. IN NO EVENT SHALL THE AUTHOR OR CONTRIBUTORS BE LIABLE FOR ANY DIRECT, INDIRECT, INCIDENTAL, SPECIAL, EXEMPLARY, OR CONSEQUENTIAL DAMAGES (INCLUDING, BUT NOT LIMITED TO, PROCUREMENT OF SUBSTITUTE GOODS OR SERVICES; LOSS OF USE, DATA, OR PROFITS; OR BUSINESS INTERRUPTION) HOWEVER CAUSED AND ON ANY THEORY OF LIABILITY, WHETHER IN CONTRACT, STRICT LIABILITY, OR TORT (INCLUDING NEGLIGENCE OR OTHERWISE) ARISING IN ANY WAY OUT OF THE USE OF THIS SOFTWARE, EVEN IF ADVISED OF THE POSSIBILITY OF SUCH DAMAGE.

### dhcpcv6

Copyright (C) 1998-2004 WIDE Project.



---

All rights reserved.

Redistribution and use in source and binary forms, with or without modification, are permitted provided that the following conditions are met:

1. Redistributions of source code must retain the above copyright notice, this list of conditions and the following disclaimer.
2. Redistributions in binary form must reproduce the above copyright notice, this list of conditions and the following disclaimer in the documentation and/or other materials provided with the distribution.
3. Neither the name of the project nor the names of its contributors may be used to endorse or promote products derived from this software without specific prior written permission.

THIS SOFTWARE IS PROVIDED BY THE PROJECT AND CONTRIBUTORS ``AS IS'' AND ANY EXPRESS OR IMPLIED WARRANTIES, INCLUDING, BUT NOT LIMITED TO, THE IMPLIED WARRANTIES OF MERCHANTABILITY AND FITNESS FOR A PARTICULAR PURPOSE ARE DISCLAIMED. IN NO EVENT SHALL THE PROJECT OR CONTRIBUTORS BE LIABLE FOR ANY DIRECT, INDIRECT, INCIDENTAL, SPECIAL, EXEMPLARY, OR CONSEQUENTIAL DAMAGES (INCLUDING, BUT NOT LIMITED TO, PROCUREMENT OF SUBSTITUTE GOODS OR SERVICES; LOSS OF USE, DATA, OR PROFITS; OR BUSINESS INTERRUPTION) HOWEVER CAUSED AND ON ANY THEORY OF LIABILITY, WHETHER IN CONTRACT, STRICT LIABILITY, OR TORT (INCLUDING NEGLIGENCE OR OTHERWISE) ARISING IN ANY WAY OUT OF THE USE OF THIS SOFTWARE, EVEN IF ADVISED OF THE POSSIBILITY OF SUCH DAMAGE.

## Encryption

Aaron D. Gifford License

Copyright (c) 2000-2001, Aaron D. Gifford

All rights reserved.

Redistribution and use in source and binary forms, with or without modification, are permitted provided that the following conditions are met:

1. Redistributions of source code must retain the above copyright notice, this list of conditions and the following disclaimer.
2. Redistributions in binary form must reproduce the above copyright notice, this list of conditions and the following disclaimer in the documentation and/or other materials provided with the distribution.
3. Neither the name of the copyright holder nor the names of contributors may be used to endorse or promote products derived from this software without specific prior written permission.

THIS SOFTWARE IS PROVIDED BY THE AUTHOR AND CONTRIBUTOR(S) ``AS IS'' AND ANY EXPRESS OR IMPLIED WARRANTIES, INCLUDING, BUT NOT LIMITED TO, THE IMPLIED WARRANTIES OF MERCHANTABILITY AND FITNESS FOR A PARTICULAR PURPOSE ARE DISCLAIMED. IN NO EVENT SHALL THE AUTHOR OR CONTRIBUTOR(S) BE LIABLE FOR ANY DIRECT, INDIRECT, INCIDENTAL, SPECIAL, EXEMPLARY, OR CONSEQUENTIAL DAMAGES (INCLUDING, BUT NOT LIMITED TO, PROCUREMENT OF SUBSTITUTE GOODS OR SERVICES; LOSS OF USE, DATA, OR PROFITS; OR BUSINESS INTERRUPTION) HOWEVER CAUSED AND ON ANY THEORY OF LIABILITY, WHETHER IN CONTRACT, STRICT LIABILITY, OR TORT (INCLUDING NEGLIGENCE OR OTHERWISE) ARISING IN ANY WAY OUT OF THE USE OF THIS SOFTWARE, EVEN IF ADVISED OF THE POSSIBILITY OF SUCH DAMAGE.

## RSA Data Security License

Copyright (C) 1990, RSA Data Security, Inc. All rights reserved.

License to copy and use this software is granted provided that it is identified as the "RSA Data Security, Inc. MD5 Message-Digest Algorithm" in all material mentioning or referencing this software or this function.

License is also granted to make and use derivative works provided that such works are identified as "derived from the RSA Data Security, Inc. MD5 Message-Digest Algorithm" in all material mentioning or referencing the derived work.

RSA Data Security, Inc. makes no representations concerning either the merchantability of this software or the suitability of this software for any particular purpose. It is provided "as is" without express or implied warranty of any kind. These notices must be retained in any copies of any part of this documentation and/or software.

Copyright (c) Broadcom Corporation

Copyright (c) The Internet Society

## expat 1.95.7

Copyright (c) 1998, 1999, 2000 Thai Open Source Software Center Ltd and Clark Cooper

Copyright (c) 2001, 2002 Expat maintainers.

Permission is hereby granted, free of charge, to any person obtaining a copy of this software and associated documentation files (the "Software"), to deal in the Software without restriction, including without limitation the rights to use, copy, modify, merge, publish, distribute, sublicense, and/or sell copies of the Software, and to permit persons to whom the Software is furnished to do so, subject to the following conditions:

The above copyright notice and this permission notice shall be included in all copies or substantial portions of the Software.

THE SOFTWARE IS PROVIDED "AS IS", WITHOUT WARRANTY OF ANY KIND, EXPRESS OR IMPLIED, INCLUDING BUT NOT LIMITED TO THE WARRANTIES OF MERCHANTABILITY, FITNESS FOR A PARTICULAR PURPOSE AND NONINFRINGEMENT. IN NO EVENT SHALL THE AUTHORS OR COPYRIGHT HOLDERS BE LIABLE FOR ANY CLAIM, DAMAGES OR OTHER LIABILITY, WHETHER IN AN ACTION OF CONTRACT, TORT OR OTHERWISE, ARISING FROM, OUT OF OR IN CONNECTION WITH THE SOFTWARE OR THE USE OR OTHER DEALINGS IN THE SOFTWARE.

### GNU General Public License 2.0 (GPL)

This ARRIS product contains the following open source software packages licensed under the terms of the GPL 2.0 license:

- Linux 2.6.30
- Arptables 0.0.3-4 (also Copyright (c) Jay Fenlason)
- bridge-utils 1.2 (also Copyright (c) Stephen Hemminger, Copyright (c) Lennery Buytenhek)
- busybox 1.18.3 (also Copyright (C) 1999-2004 by Erik Andersen <andersen@codepoet.org>)
- conntrack 1.0.1
- dnsmasq 2.45 (also Copyright (c) Simon Kelley)
- ebtables 2.0.10-2 (also Copyright (c) Bart De Schuymer)
- ez-ipupdate 3.0.11b7 (also Copyright (c) Angus Mackay)
- haserl 0.9.26 (also Copyright (c) 2003-2007 Nathan Angelacos)
- inetd (also Copyright (c) Kenneth Albanowski Copyright (c) D. Jeff Dionne Copyright (c) Lineo, Inc.)
- iproute2 (also Copyright (c) Rusty Russell, Copyright (c) The Regents of the University of California, Copyright (c) USAGI WIDE Project, Copyright (c) Free Software Foundation, Copyright (c) Intel Corp. Copyright (c) Robert Olsson Uppsala University Sweden, Copyright (c) Harald Welte)
- iptables 1.4.0 (also Copyright (c) Netfilter Core Team)
- libnftfilter\_conntrack (also (C) 2005-2011 Pablo Neira Ayuso)
- libnftnetlink (also "(c) 2001-2005 Netfilter Core Team, (c) 2008 by Pablo Neira Ayuso <pablo@netfilter.org>, (c) 2004 by Astaro AG, written by Harald Welte, (c) 2002-2006 by Harald Welte <laforge@gnumonks.org>")
- mtd-utils 1.4.9 (also Copyright Texas Instruments)
- ntpclient 2003\_194 (also Copyright (c) Larry Doolittle)
- pppd 2.4.4 (also Copyright Fred N. van Kempen, <waltje@uWalt.NL.Mugnet.ORG>, Copyright Donald Becker, <becker@super.org>, Copyright Alan Cox, <alan@lxorguk.ukuu.org.uk>, Copyright Steve Whitehouse, <gw7rrm@eeshack3.swan.ac.uk>)
- rp-pppoe 3.10
- samba 3.0.25a (also Copyright (c) Ricky Poulten 1995-1998, Copyright (c) Richard Sharpe 1998)
- udev 136 (also Copyright (C) Kay Sievers)
- vconfig 1.6 (also Copyright (c) Ben Greear)
- wget 1.10.2 (also copyright (c) GNU Wget Authors)

### GNU GENERAL PUBLIC LICENSE

Version 2, June 1991

Copyright (C) 1989, 1991 Free Software Foundation, Inc.,  
51 Franklin Street, Fifth Floor, Boston, MA 02110-1301 USA

Everyone is permitted to copy and distribute verbatim copies of this license document, but changing it is not allowed.

#### Preamble

The licenses for most software are designed to take away your freedom to share and change it. By contrast, the GNU General Public License is intended to guarantee your freedom to share and change free software--to make sure the software is free for all its users. This General Public License applies to most of the Free Software Foundation's software and to any other program whose authors commit to using it. (Some other Free Software Foundation software is covered by the GNU Lesser General Public License instead.) You can apply it to your programs, too.

---

When we speak of free software, we are referring to freedom, not price. Our General Public Licenses are designed to make sure that you have the freedom to distribute copies of free software (and charge for this service if you wish), that you receive source code or can get it if you want it, that you can change the software or use pieces of it in new free programs; and that you know you can do these things.

To protect your rights, we need to make restrictions that forbid anyone to deny you these rights or to ask you to surrender the rights. These restrictions translate to certain responsibilities for you if you distribute copies of the software, or if you modify it.

For example, if you distribute copies of such a program, whether gratis or for a fee, you must give the recipients all the rights that you have. You must make sure that they, too, receive or can get the source code. And you must show them these terms so they know their rights.

We protect your rights with two steps: (1) copyright the software, and (2) offer you this license which gives you legal permission to copy, distribute and/or modify the software.

Also, for each author's protection and ours, we want to make certain that everyone understands that there is no warranty for this free software. If the software is modified by someone else and passed on, we want its recipients to know that what they have is not the original, so that any problems introduced by others will not reflect on the original authors' reputations.

Finally, any free program is threatened constantly by software patents. We wish to avoid the danger that redistributors of a free program will individually obtain patent licenses, in effect making the program proprietary. To prevent this, we have made it clear that any patent must be licensed for everyone's free use or not licensed at all.

The precise terms and conditions for copying, distribution and modification follow.

#### GNU GENERAL PUBLIC LICENSE TERMS AND CONDITIONS FOR COPYING, DISTRIBUTION AND MODIFICATION

0. This License applies to any program or other work which contains a notice placed by the copyright holder saying it may be distributed under the terms of this General Public License. The "Program", below, refers to any such program or work, and a "work based on the Program" means either the Program or any derivative work under copyright law: that is to say, a work containing the Program or a portion of it, either verbatim or with modifications and/or translated into another language. (Hereinafter, translation is included without limitation in the term "modification".) Each licensee is addressed as "you".

Activities other than copying, distribution and modification are not covered by this License; they are outside its scope. The act of running the Program is not restricted, and the output from the Program is covered only if its contents constitute a work based on the Program (independent of having been made by running the Program). Whether that is true depends on what the Program does.

1. You may copy and distribute verbatim copies of the Program's source code as you receive it, in any medium, provided that you conspicuously and appropriately publish on each copy an appropriate copyright notice and disclaimer of warranty; keep intact all the notices that refer to this License and to the absence of any warranty; and give any other recipients of the Program a copy of this License along with the Program.

You may charge a fee for the physical act of transferring a copy, and you may at your option offer warranty protection in exchange for a fee.

2. You may modify your copy or copies of the Program or any portion of it, thus forming a work based on the Program, and copy and distribute such modifications or work under the terms of Section 1 above, provided that you also meet all of these conditions:

a) You must cause the modified files to carry prominent notices stating that you changed the files and the date of any change.

b) You must cause any work that you distribute or publish, that in whole or in part contains or is derived from the Program or any part thereof, to be licensed as a whole at no charge to all third parties under the terms of this License.

c) If the modified program normally reads commands interactively when run, you must cause it, when started running for such interactive use in the most ordinary way, to print or display an announcement including an appropriate copyright notice and a notice that there is no warranty (or else, saying that you provide a warranty) and that users may redistribute the program under these conditions, and telling the user how to view a copy of this License. (Exception: if the Program itself is interactive but does not normally print such an announcement, your work based on the Program is not required to print an announcement.)

These requirements apply to the modified work as a whole. If identifiable sections of that work are not derived from the Program, and can be reasonably considered independent and separate works in themselves, then this License, and its terms, do not apply to those sections when you distribute them as separate works. But when you distribute the same sections as part of a whole which is a work based on the Program, the distribution of the whole must be on the terms of this License, whose permissions for other licensees extend to the entire whole, and thus to each and every part regardless of who wrote it.

Thus, it is not the intent of this section to claim rights or contest your rights to work written entirely by you; rather, the intent is to exercise the right to control the distribution of derivative or collective works based on the Program.

In addition, mere aggregation of another work not based on the Program with the Program (or with a work based on the Program) on a volume of a storage or distribution medium does not bring the other work under the scope of this License.

3. You may copy and distribute the Program (or a work based on it, under Section 2) in object code or executable form under the terms of Sections 1 and 2 above provided that you also do one of the following:

a) Accompany it with the complete corresponding machine-readable source code, which must be distributed under the terms of Sections 1 and 2 above on a medium customarily used for software interchange; or,

b) Accompany it with a written offer, valid for at least three years, to give any third party, for a charge no more than your cost of physically performing source distribution, a complete machine-readable copy of the corresponding source code, to be distributed under the terms of Sections 1 and 2 above on a medium customarily used for software interchange; or,

c) Accompany it with the information you received as to the offer to distribute corresponding source code. (This alternative is allowed only for noncommercial distribution and only if you received the program in object code or executable form with such an offer, in accord with Subsection b above.)

The source code for a work means the preferred form of the work for making modifications to it. For an executable work, complete source code means all the source code for all modules it contains, plus any associated interface definition files, plus the scripts used to control compilation and installation of the executable. However, as a special exception, the source code distributed need not include anything that is normally distributed (in either source or binary form) with the major components (compiler, kernel, and so on) of the operating system on which the executable runs, unless that component itself accompanies the executable.

If distribution of executable or object code is made by offering access to copy from a designated place, then offering equivalent access to copy the source code from the same place counts as distribution of the source code, even though third parties are not compelled to copy the source along with the object code.

4. You may not copy, modify, sublicense, or distribute the Program except as expressly provided under this License. Any attempt otherwise to copy, modify, sublicense or distribute the Program is void, and will automatically terminate your rights under this License. However, parties who have received copies, or rights, from you under this License will not have their licenses terminated so long as such parties remain in full compliance.

5. You are not required to accept this License, since you have not signed it. However, nothing else grants you permission to modify or distribute the Program or its derivative works. These actions are prohibited by law if you do not accept this License. Therefore, by modifying or distributing the Program (or any work based on the Program), you indicate your acceptance of this License to do so, and all its terms and conditions for copying, distributing or modifying the Program or works based on it.

---

6. Each time you redistribute the Program (or any work based on the Program), the recipient automatically receives a license from the original licensor to copy, distribute or modify the Program subject to these terms and conditions. You may not impose any further restrictions on the recipients' exercise of the rights granted herein. You are not responsible for enforcing compliance by third parties to this License.

7. If, as a consequence of a court judgment or allegation of patent infringement or for any other reason (not limited to patent issues), conditions are imposed on you (whether by court order, agreement or otherwise) that contradict the conditions of this License, they do not excuse you from the conditions of this License. If you cannot distribute so as to satisfy simultaneously your obligations under this License and any other pertinent obligations, then as a consequence you may not distribute the Program at all. For example, if a patent license would not permit royalty-free redistribution of the Program by all those who receive copies directly or indirectly through you, then the only way you could satisfy both it and this License would be to refrain entirely from distribution of the Program.

If any portion of this section is held invalid or unenforceable under any particular circumstance, the balance of the section is intended to apply and the section as a whole is intended to apply in other circumstances.

It is not the purpose of this section to induce you to infringe any patents or other property right claims or to contest validity of any such claims; this section has the sole purpose of protecting the integrity of the free software distribution system, which is implemented by public license practices. Many people have made generous contributions to the wide range of software distributed through that system in reliance on consistent application of that system; it is up to the author/donor to decide if he or she is willing to distribute software through any other system and a licensee cannot impose that choice.

This section is intended to make thoroughly clear what is believed to be a consequence of the rest of this License.

8. If the distribution and/or use of the Program is restricted in certain countries either by patents or by copyrighted interfaces, the original copyright holder who places the Program under this License may add an explicit geographical distribution limitation excluding those countries, so that distribution is permitted only in or among countries not thus excluded. In such case, this License incorporates the limitation as if written in the body of this License.

9. The Free Software Foundation may publish revised and/or new versions of the General Public License from time to time. Such new versions will be similar in spirit to the present version, but may differ in detail to address new problems or concerns.

Each version is given a distinguishing version number. If the Program specifies a version number of this License which applies to it and "any later version", you have the option of following the terms and conditions either of that version or of any later version published by the Free Software Foundation. If the Program does not specify a version number of this License, you may choose any version ever published by the Free Software Foundation.

10. If you wish to incorporate parts of the Program into other free programs whose distribution conditions are different, write to the author to ask for permission. For software which is copyrighted by the Free Software Foundation, write to the Free Software Foundation; we sometimes make exceptions for this. Our decision will be guided by the two goals of preserving the free status of all derivatives of our free software and of promoting the sharing and reuse of software generally.

#### NO WARRANTY

11. BECAUSE THE PROGRAM IS LICENSED FREE OF CHARGE, THERE IS NO WARRANTY FOR THE PROGRAM, TO THE EXTENT PERMITTED BY APPLICABLE LAW. EXCEPT WHEN OTHERWISE STATED IN WRITING THE COPYRIGHT HOLDERS AND/OR OTHER PARTIES PROVIDE THE PROGRAM "AS IS" WITHOUT WARRANTY OF ANY KIND, EITHER EXPRESSED OR IMPLIED, INCLUDING, BUT NOT LIMITED TO, THE IMPLIED WARRANTIES OF MERCHANTABILITY AND FITNESS FOR A PARTICULAR PURPOSE. THE ENTIRE RISK AS TO THE QUALITY AND PERFORMANCE OF THE PROGRAM IS WITH YOU. SHOULD THE PROGRAM PROVE DEFECTIVE, YOU ASSUME THE COST OF ALL NECESSARY SERVICING, REPAIR OR CORRECTION.

12. IN NO EVENT UNLESS REQUIRED BY APPLICABLE LAW OR AGREED TO IN WRITING WILL ANY COPYRIGHT HOLDER, OR ANY OTHER PARTY WHO MAY MODIFY AND/OR REDISTRIBUTE THE PROGRAM AS PERMITTED ABOVE, BE LIABLE TO YOU FOR DAMAGES, INCLUDING ANY GENERAL, SPECIAL, INCIDENTAL OR CONSEQUENTIAL DAMAGES ARISING OUT OF THE USE OR INABILITY TO USE THE PROGRAM (INCLUDING BUT NOT LIMITED TO LOSS OF DATA OR DATA BEING RENDERED INACCURATE OR LOSSES SUSTAINED BY YOU OR THIRD PARTIES OR A FAILURE OF THE PROGRAM TO OPERATE WITH ANY OTHER PROGRAMS), EVEN IF SUCH HOLDER OR OTHER PARTY HAS BEEN ADVISED OF THE POSSIBILITY OF SUCH DAMAGES.

### END OF TERMS AND CONDITIONS

## GNU Lesser General Public License 2.1 (LGPL)

This ARRIS product contains the following open source software packages licensed under the terms of the LGPL 2.1 license:

- uClibc 0.9.27 (also Copyright (C) 2000-2006 Erik Andersen <andersen@uclibc.org>)

Version 2.1, February 1999

Copyright (C) 1991, 1999 Free Software Foundation, Inc.

51 Franklin Street, Fifth Floor, Boston, MA 02110-1301 USA

Everyone is permitted to copy and distribute verbatim copies of this license document, but changing it is not allowed.

[This is the first released version of the Lesser GPL. It also counts as the successor of the GNU Library Public License, version 2, hence the version number 2.1.]

#### Preamble

The licenses for most software are designed to take away your freedom to share and change it. By contrast, the GNU General Public Licenses are intended to guarantee your freedom to share and change free software--to make sure the software is free for all its users.

This license, the Lesser General Public License, applies to some specially designated software packages--typically libraries--of the Free Software Foundation and other authors who decide to use it. You can use it too, but we suggest you first think carefully about whether this license or the ordinary General Public License is the better strategy to use in any particular case, based on the explanations below.

When we speak of free software, we are referring to freedom of use, not price. Our General Public Licenses are designed to make sure that you have the freedom to distribute copies of free software (and charge for this service if you wish); that you receive source code or can get it if you want it; that you can change the software and use pieces of it in new free programs; and that you are informed that you can do these things.

To protect your rights, we need to make restrictions that forbid distributors to deny you these rights or to ask you to surrender these rights. These restrictions translate to certain responsibilities for you if you distribute copies of the library or if you modify it.

For example, if you distribute copies of the library, whether gratis or for a fee, you must give the recipients all the rights that we gave you. You must make sure that they, too, receive or can get the source code. If you link other code with the library, you must provide complete object files to the recipients, so that they can relink them with the library after making changes to the library and recompiling it. And you must show them these terms so they know their rights.

We protect your rights with a two-step method: (1) we copyright the library, and (2) we offer you this license, which gives you legal permission to copy, distribute and/or modify the library.

To protect each distributor, we want to make it very clear that there is no warranty for the free library. Also, if the library is modified by someone else and passed on, the recipients should know that what they have is not the original version, so that the original author's reputation will not be affected by problems that might be introduced by others.

Finally, software patents pose a constant threat to the existence of any free program. We wish to make sure that a company cannot effectively restrict the users of a free program by obtaining a restrictive license from a patent holder. Therefore, we insist that any patent license obtained for a version of the library must be consistent with the full freedom of use specified in this license.

Most GNU software, including some libraries, is covered by the ordinary GNU General Public License. This license, the GNU Lesser General Public License, applies to certain designated libraries, and is quite different from the ordinary General Public License. We use this license for certain libraries in order to permit linking those libraries into non-free programs.

When a program is linked with a library, whether statically or using a shared library, the combination of the two is legally speaking a combined work, a derivative of the original library. The ordinary General Public License therefore permits such linking only if the entire combination fits its criteria of freedom. The Lesser General Public License permits more lax criteria for linking other code with the library.

We call this license the "Lesser" General Public License because it does Less to protect the user's freedom than the ordinary General Public License. It also provides other free software developers Less of an advantage over competing non-free programs. These disadvantages are the reason we use the ordinary General Public License for many libraries. However, the Lesser license provides advantages in certain special circumstances.

For example, on rare occasions, there may be a special need to encourage the widest possible use of a certain library, so that it becomes a de-facto standard. To achieve this, non-free programs must be allowed to use the library. A more frequent case is that a free library does the same job as widely used non-free libraries. In this case, there is little to gain by limiting the free library to free software only, so we use the Lesser General Public License.

In other cases, permission to use a particular library in non-free programs enables a greater number of people to use a large body of free software. For example, permission to use the GNU C Library in non-free programs enables many more people to use the whole GNU operating system, as well as its variant, the GNU/Linux operating system.

Although the Lesser General Public License is Less protective of the users' freedom, it does ensure that the user of a program that is linked with the Library has the freedom and the wherewithal to run that program using a modified version of the Library.

---

The precise terms and conditions for copying, distribution and modification follow. Pay close attention to the difference between a "work based on the library" and a "work that uses the library". The former contains code derived from the library, whereas the latter must be combined with the library in order to run.

#### TERMS AND CONDITIONS FOR COPYING, DISTRIBUTION AND MODIFICATION

0. This License Agreement applies to any software library or other program which contains a notice placed by the copyright holder or other authorized party saying it may be distributed under the terms of this Lesser General Public License (also called "this License"). Each licensee is addressed as "you".

A "library" means a collection of software functions and/or data prepared so as to be conveniently linked with application programs (which use some of those functions and data) to form executables.

The "Library", below, refers to any such software library or work which has been distributed under these terms. A "work based on the Library" means either the Library or any derivative work under copyright law: that is to say, a work containing the Library or a portion of it, either verbatim or with modifications and/or translated straightforwardly into another language. (Hereinafter, translation is included without limitation in the term "modification".)

"Source code" for a work means the preferred form of the work for making modifications to it. For a library, complete source code means all the source code for all modules it contains, plus any associated interface definition files, plus the scripts used to control compilation and installation of the library.

Activities other than copying, distribution and modification are not covered by this License; they are outside its scope. The act of running a program using the Library is not restricted, and output from such a program is covered only if its contents constitute a work based on the Library (independent of the use of the Library in a tool for writing it). Whether that is true depends on what the Library does and what the program that uses the Library does.

1. You may copy and distribute verbatim copies of the Library's complete source code as you receive it, in any medium, provided that you conspicuously and appropriately publish on each copy an appropriate copyright notice and disclaimer of warranty; keep intact all the notices that refer to this License and to the absence of any warranty; and distribute a copy of this License along with the Library.

You may charge a fee for the physical act of transferring a copy, and you may at your option offer warranty protection in exchange for a fee.

2. You may modify your copy or copies of the Library or any portion of it, thus forming a work based on the Library, and copy and distribute such modifications or work under the terms of Section 1 above, provided that you also meet all of these conditions:

\* a) The modified work must itself be a software library.

\* b) You must cause the files modified to carry prominent notices stating that you changed the files and the date of any change.

\* c) You must cause the whole of the work to be licensed at no charge to all third parties under the terms of this License.

\* d) If a facility in the modified Library refers to a function or a table of data to be supplied by an application program that uses the facility, other than as an argument passed when the facility is invoked, then you must make a good faith effort to ensure that, in the event an application does not supply such function or table, the facility still operates, and performs whatever part of its purpose remains meaningful.

(For example, a function in a library to compute square roots has a purpose that is entirely well-defined independent of the application. Therefore, Subsection 2d requires that any application-supplied function or table used by this function must be optional: if the application does not supply it, the square root function must still compute square roots.)

These requirements apply to the modified work as a whole. If identifiable sections of that work are not derived from the Library, and can be reasonably considered independent and separate works in themselves, then this License, and its terms, do not apply to those sections when you distribute them as separate works. But when you distribute the same sections as part of a whole which is a work based on the Library, the distribution of the whole must be on the terms of this License, whose permissions for other licensees extend to the entire whole, and thus to each and every part regardless of who wrote it.

Thus, it is not the intent of this section to claim rights or contest your rights to work written entirely by you; rather, the intent is to exercise the right to control the distribution of derivative or collective works based on the Library.

In addition, mere aggregation of another work not based on the Library with the Library (or with a work based on the Library) on a volume of a storage or distribution medium does not bring the other work under the scope of this License.

3. You may opt to apply the terms of the ordinary GNU General Public License instead of this License to a given copy of the Library. To do this, you must alter all the notices that refer to this License, so that they refer to the ordinary GNU General Public License, version 2, instead of to this License. (If a newer version than version 2 of the ordinary GNU General Public License has appeared, then you can specify that version instead if you wish.) Do not make any other change in these notices.

Once this change is made in a given copy, it is irreversible for that copy, so the ordinary GNU General Public License applies to all subsequent copies and derivative works made from that copy.

This option is useful when you wish to copy part of the code of the Library into a program that is not a library.

4. You may copy and distribute the Library (or a portion or derivative of it, under Section 2) in object code or executable form under the terms of Sections 1 and 2 above provided that you accompany it with the complete corresponding machine-readable source code, which must be distributed under the terms of Sections 1 and 2 above on a medium customarily used for software interchange.

If distribution of object code is made by offering access to copy from a designated place, then offering equivalent access to copy the source code from the same place satisfies the requirement to distribute the source code, even though third parties are not compelled to copy the source along with the object code.

5. A program that contains no derivative of any portion of the Library, but is designed to work with the Library by being compiled or linked with it, is called a "work that uses the Library". Such a work, in isolation, is not a derivative work of the Library, and therefore falls outside the scope of this License.

However, linking a "work that uses the Library" with the Library creates an executable that is a derivative of the Library (because it contains portions of the Library), rather than a "work that uses the library". The executable is therefore covered by this License. Section 6 states terms for distribution of such executables.

When a "work that uses the Library" uses material from a header file that is part of the Library, the object code for the work may be a derivative work of the Library even though the source code is not. Whether this is true is especially significant if the work can be linked without the Library, or if the work is itself a library. The threshold for this to be true is not precisely defined by law.

If such an object file uses only numerical parameters, data structure layouts and accessors, and small macros and small inline functions (ten lines or less in length), then the use of the object file is unrestricted, regardless of whether it is legally a derivative work. (Executables containing this object code plus portions of the Library will still fall under Section 6.)

Otherwise, if the work is a derivative of the Library, you may distribute the object code for the work under the terms of Section 6. Any executables containing that work also fall under Section 6, whether or not they are linked directly with the Library itself.

6. As an exception to the Sections above, you may also combine or link a "work that uses the Library" with the Library to produce a work containing portions of the Library, and distribute that work under terms of your choice, provided that the terms permit modification of the work for the customer's own use and reverse engineering for debugging such modifications.

You must give prominent notice with each copy of the work that the Library is used in it and that the Library and its use are covered by this License. You must supply a copy of this License. If the work during execution displays copyright notices, you must include the copyright notice for the Library among them, as well as a reference directing the user to the copy of this License. Also, you must do one of these things:

\* a) Accompany the work with the complete corresponding machine-readable source code for the Library including whatever changes were used in the work (which must be distributed under Sections 1 and 2 above); and, if the work is an executable linked with the Library, with the complete machine-readable "work that uses the Library", as object code and/or source code, so that the user can modify the Library and then relink to produce a modified executable containing the modified Library. (It is understood that the user who changes the contents of definitions files in the Library will not necessarily be able to recompile the application to use the modified definitions.)

\* b) Use a suitable shared library mechanism for linking with the Library. A suitable mechanism is one that (1) uses at run time a copy of the library already present on the user's computer system, rather than copying library functions into the executable, and (2) will operate properly with a modified version of the library, if the user installs one, as long as the modified version is interface-compatible with the version that the work was made with.

\* c) Accompany the work with a written offer, valid for at least three years, to give the same user the materials specified in Subsection 6a, above, for a charge no more than the cost of performing this distribution.

\* d) If distribution of the work is made by offering access to copy from a designated place, offer equivalent access to copy the above specified materials from the same place.

\* e) Verify that the user has already received a copy of these materials or that you have already sent this user a copy.

For an executable, the required form of the "work that uses the Library" must include any data and utility programs needed for reproducing the executable from it. However, as a special exception, the materials to be distributed need not include anything that is normally distributed (in either source or binary form) with the major components (compiler, kernel, and so on) of the operating system on which the executable runs, unless that component itself accompanies the executable.

It may happen that this requirement contradicts the license restrictions of other proprietary libraries that do not normally accompany the operating system. Such a contradiction means you cannot use both them and the Library together in an executable that you distribute.

7. You may place library facilities that are a work based on the Library side-by-side in a single library together with other library facilities not covered by this License, and distribute such a combined library, provided that the separate distribution of the work based on the Library and of the other library facilities is otherwise permitted, and provided that you do these two things:

\* a) Accompany the combined library with a copy of the same work based on the Library, uncombined with any other library facilities. This must be distributed under the terms of the Sections above.

\* b) Give prominent notice with the combined library of the fact that part of it is a work based on the Library, and explaining where to find the accompanying uncombined form of the same work.

8. You may not copy, modify, sublicense, link with, or distribute the Library except as expressly provided under this License. Any attempt otherwise to copy, modify, sublicense, link with, or distribute the Library is void, and will automatically terminate your rights under this License. However, parties who have received copies, or rights, from you under this License will not have their licenses terminated so long as such parties remain in full compliance.

9. You are not required to accept this License, since you have not signed it. However, nothing else grants you permission to modify or distribute the Library or its derivative works. These actions are prohibited by law if you do not accept this License. Therefore, by modifying or distributing the Library (or any work based on the Library), you indicate your acceptance of this License to do so, and all its terms and conditions for copying, distributing or modifying the Library or works based on it.

10. Each time you redistribute the Library (or any work based on the Library), the recipient automatically receives a license from the original licensor to copy, distribute, link with or modify the Library subject to these terms and conditions. You may not impose any further restrictions on the recipients' exercise of the rights granted herein. You are not responsible for enforcing compliance by third parties with this License.



---

11. If, as a consequence of a court judgment or allegation of patent infringement or for any other reason (not limited to patent issues), conditions are imposed on you (whether by court order, agreement or otherwise) that contradict the conditions of this License, they do not excuse you from the conditions of this License. If you cannot distribute so as to satisfy simultaneously your obligations under this License and any other pertinent obligations, then as a consequence you may not distribute the Library at all. For example, if a patent license would not permit royalty-free redistribution of the Library by all those who receive copies directly or indirectly through you, then the only way you could satisfy both it and this License would be to refrain entirely from distribution of the Library.

If any portion of this section is held invalid or unenforceable under any particular circumstance, the balance of the section is intended to apply, and the section as a whole is intended to apply in other circumstances.

It is not the purpose of this section to induce you to infringe any patents or other property right claims or to contest validity of any such claims; this section has the sole purpose of protecting the integrity of the free software distribution system which is implemented by public license practices. Many people have made generous contributions to the wide range of software distributed through that system in reliance on consistent application of that system; it is up to the author/donor to decide if he or she is willing to distribute software through any other system and a licensee cannot impose that choice.

This section is intended to make thoroughly clear what is believed to be a consequence of the rest of this License.

12. If the distribution and/or use of the Library is restricted in certain countries either by patents or by copyrighted interfaces, the original copyright holder who places the Library under this License may add an explicit geographical distribution limitation excluding those countries, so that distribution is permitted only in or among countries not thus excluded. In such case, this License incorporates the limitation as if written in the body of this License.

13. The Free Software Foundation may publish revised and/or new versions of the Lesser General Public License from time to time. Such new versions will be similar in spirit to the present version, but may differ in detail to address new problems or concerns.

Each version is given a distinguishing version number. If the Library specifies a version number of this License which applies to it and "any later version", you have the option of following the terms and conditions either of that version or of any later version published by the Free Software Foundation. If the Library does not specify a license version number, you may choose any version ever published by the Free Software Foundation.

14. If you wish to incorporate parts of the Library into other free programs whose distribution conditions are incompatible with these, write to the author to ask for permission. For software which is copyrighted by the Free Software Foundation, write to the Free Software Foundation; we sometimes make exceptions for this. Our decision will be guided by the two goals of preserving the free status of all derivatives of our free software and of promoting the sharing and reuse of software generally.

#### NO WARRANTY

15. BECAUSE THE LIBRARY IS LICENSED FREE OF CHARGE, THERE IS NO WARRANTY FOR THE LIBRARY, TO THE EXTENT PERMITTED BY APPLICABLE LAW. EXCEPT WHEN OTHERWISE STATED IN WRITING THE COPYRIGHT HOLDERS AND/OR OTHER PARTIES PROVIDE THE LIBRARY "AS IS" WITHOUT WARRANTY OF ANY KIND, EITHER EXPRESSED OR IMPLIED, INCLUDING, BUT NOT LIMITED TO, THE IMPLIED WARRANTIES OF MERCHANTABILITY AND FITNESS FOR A PARTICULAR PURPOSE. THE ENTIRE RISK AS TO THE QUALITY AND PERFORMANCE OF THE LIBRARY IS WITH YOU. SHOULD THE LIBRARY PROVE DEFECTIVE, YOU ASSUME THE COST OF ALL NECESSARY SERVICING, REPAIR OR CORRECTION.

16. IN NO EVENT UNLESS REQUIRED BY APPLICABLE LAW OR AGREED TO IN WRITING WILL ANY COPYRIGHT HOLDER, OR ANY OTHER PARTY WHO MAY MODIFY AND/OR REDISTRIBUTE THE LIBRARY AS PERMITTED ABOVE, BE LIABLE TO YOU FOR DAMAGES, INCLUDING ANY GENERAL, SPECIAL, INCIDENTAL OR CONSEQUENTIAL DAMAGES ARISING OUT OF THE USE OR INABILITY TO USE THE LIBRARY (INCLUDING BUT NOT LIMITED TO LOSS OF DATA OR DATA BEING RENDERED INACCURATE OR LOSSES SUSTAINED BY YOU OR THIRD PARTIES OR A FAILURE OF THE LIBRARY TO OPERATE WITH ANY OTHER SOFTWARE), EVEN IF SUCH HOLDER OR OTHER PARTY HAS BEEN ADVISED OF THE POSSIBILITY OF SUCH DAMAGES.

END OF TERMS AND CONDITIONS

## libtecla 1.6.1

Martin C. Shepherd License

Copyright (c) 2000, 2001, 2002, 2003, 2004 by Martin C. Shepherd.

All rights reserved.

Permission is hereby granted, free of charge, to any person obtaining a copy of this software and associated documentation files (the "Software"), to deal in the Software without restriction, including without limitation the rights to use, copy, modify, merge, publish, distribute, and/or sell copies of the Software, and to permit persons to whom the Software is furnished to do so, provided that the above copyright notice(s) and this permission notice appear in all copies of the Software and that both the above copyright notice(s) and this permission notice appear in supporting documentation. THE SOFTWARE IS PROVIDED "AS IS", WITHOUT WARRANTY OF ANY KIND, EXPRESSOR IMPLIED, INCLUDING BUT NOT LIMITED TO THE WARRANTIES OF MERCHANTABILITY, FITNESS FOR A PARTICULAR PURPOSE AND NONINFRINGEMENT OF THIRD PARTY RIGHTS. IN NO EVENT SHALL THE COPYRIGHT HOLDER OR HOLDERS INCLUDED IN THIS NOTICE BE LIABLE FOR ANY CLAIM, OR ANY SPECIAL INDIRECT OR CONSEQUENTIAL DAMAGES, OR ANY DAMAGES WHATSOEVER RESULTING FROM LOSS OF USE, DATA OR PROFITS, WHETHER IN AN ACTION OF CONTRACT, NEGLIGENCE OR OTHER TORTIOUS ACTION, ARISING OUT OF OR IN CONNECTION WITH THE USE OR PERFORMANCE OF THIS SOFTWARE. Except as contained in this notice, the name of a copyright holder shall not be used in advertising or otherwise to promote the sale, use or other dealings in this Software without prior written authorization of the copyright holder.

### lua 5.1

Lua is licensed under the terms of the MIT license reproduced below. This means that Lua is free software and can be used for both academic and commercial purposes at absolutely no cost.

For details and rationale, see <http://www.lua.org/license.html> .

Copyright (C) 1994,2012 Lua.org, PUC-Rio.

Permission is hereby granted, free of charge, to any person obtaining a copy of this software and associated documentation files (the "Software"), to deal in the Software without restriction, including without limitation the rights to use, copy, modify, merge, publish, distribute, sublicense, and/or sell copies of the Software, and to permit persons to whom the Software is furnished to do so, subject to the following conditions:

The above copyright notice and this permission notice shall be included in all copies or substantial portions of the Software.

THE SOFTWARE IS PROVIDED "AS IS", WITHOUT WARRANTY OF ANY KIND, EXPRESS OR IMPLIED, INCLUDING BUT NOT LIMITED TO THE WARRANTIES OF MERCHANTABILITY, FITNESS FOR A PARTICULAR PURPOSE AND NONINFRINGEMENT. IN NO EVENT SHALL THE AUTHORS OR COPYRIGHT HOLDERS BE LIABLE FOR ANY CLAIM, DAMAGES OR OTHER LIABILITY, WHETHER IN AN ACTION OF CONTRACT, TORT OR OTHERWISE, ARISING FROM, OUT OF OR IN CONNECTION WITH THE SOFTWARE OR THE USE OR OTHER DEALINGS IN THE SOFTWARE.

### miniupnp 20070228

Thomas BERNARD License

Copyright (c) 2006-2007, Thomas BERNARD

All rights reserved.

Redistribution and use in source and binary forms, with or without modification, are permitted provided that the following conditions are met:

- \* Redistributions of source code must retain the above copyright notice, this list of conditions and the following disclaimer.

- \* Redistributions in binary form must reproduce the above copyright notice, this list of conditions and the following disclaimer in the documentation and/or other materials provided with the distribution.

- \* The name of the author may not be used to endorse or promote products derived from this software without specific prior written permission.

THIS SOFTWARE IS PROVIDED BY THE COPYRIGHT HOLDERS AND CONTRIBUTORS "AS IS" AND ANY EXPRESS OR IMPLIED WARRANTIES, INCLUDING, BUT NOT LIMITED TO, THE IMPLIED WARRANTIES OF MERCHANTABILITY AND FITNESS FOR A PARTICULAR PURPOSE ARE DISCLAIMED. IN NO EVENT SHALL THE COPYRIGHT OWNER OR CONTRIBUTORS BE LIABLE FOR ANY DIRECT, INDIRECT, INCIDENTAL, SPECIAL, EXEMPLARY, OR CONSEQUENTIAL DAMAGES (INCLUDING, BUT NOT LIMITED TO, PROCUREMENT OF SUBSTITUTE GOODS OR SERVICES; LOSS OF USE, DATA, OR PROFITS; OR BUSINESS INTERRUPTION) HOWEVER CAUSED AND ON ANY THEORY OF LIABILITY, WHETHER IN CONTRACT, STRICT LIABILITY, OR TORT (INCLUDING NEGLIGENCE OR OTHERWISE) ARISING IN ANY WAY OUT OF THE USE OF THIS SOFTWARE, EVEN IF ADVISED OF THE POSSIBILITY OF SUCH DAMAGE.

### muhttp 1.1.3

Copyright (c) 2005 Robbert Haarman

Permission is hereby granted, free of charge, to any person obtaining a copy of this software and associated documentation files (the "Software"), to deal in the Software without restriction, including without limitation the rights to use, copy, modify, merge, publish, distribute, sublicense, and/or sell copies of the Software, and to permit persons to whom the Software is furnished to do so, subject to the following conditions:

The above copyright notice and this permission notice shall be included in all copies or substantial portions of the Software.

THE SOFTWARE IS PROVIDED "AS IS", WITHOUT WARRANTY OF ANY KIND, EXPRESS OR IMPLIED, INCLUDING BUT NOT LIMITED TO THE WARRANTIES OF MERCHANTABILITY, FITNESS FOR A PARTICULAR PURPOSE AND NONINFRINGEMENT. IN NO EVENT SHALL THE AUTHORS OR COPYRIGHT HOLDERS BE LIABLE FOR ANY CLAIM, DAMAGES OR OTHER LIABILITY, WHETHER IN AN ACTION OF CONTRACT, TORT OR OTHERWISE, ARISING FROM, OUT OF OR IN CONNECTION WITH THE SOFTWARE OR THE USE OR OTHER DEALINGS IN THE SOFTWARE.

---

## OpenSSL 0.9.8k

### OpenSSL SSLeay License

#### LICENSE ISSUES

The OpenSSL toolkit stays under a dual license, i.e. both the conditions of the OpenSSL License and the original SSLeay license apply to the toolkit. See below for the actual license texts. Actually both licenses are BSD-style Open Source licenses. In case of any license issues related to OpenSSL please contact [openssl-core@openssl.org](mailto:openssl-core@openssl.org).

#### OpenSSL License

-----  
Copyright (c) 1998-2008 The OpenSSL Project. All rights reserved.

Redistribution and use in source and binary forms, with or without modification, are permitted provided that the following conditions are met:

1. Redistributions of source code must retain the above copyright notice, this list of conditions and the following disclaimer.
2. Redistributions in binary form must reproduce the above copyright notice, this list of conditions and the following disclaimer in the documentation and/or other materials provided with the distribution.
3. All advertising materials mentioning features or use of this software must display the following acknowledgment:

"This product includes software developed by the OpenSSL Project for use in the OpenSSL Toolkit. (<http://www.openssl.org/>)"

4. The names "OpenSSL Toolkit" and "OpenSSL Project" must not be used to endorse or promote products derived from this software without prior written permission. For written permission, please contact [openssl-core@openssl.org](mailto:openssl-core@openssl.org).

5. Products derived from this software may not be called "OpenSSL" nor may "OpenSSL" appear in their names without prior written permission of the OpenSSL Project.

6. Redistributions of any form whatsoever must retain the following acknowledgment:

"This product includes software developed by the OpenSSL Project for use in the OpenSSL Toolkit (<http://www.openssl.org/>)"

THIS SOFTWARE IS PROVIDED BY THE OpenSSL PROJECT "AS IS" AND ANY EXPRESSED OR IMPLIED WARRANTIES, INCLUDING, BUT NOT LIMITED TO, THE IMPLIED WARRANTIES OF MERCHANTABILITY AND FITNESS FOR A PARTICULAR PURPOSE ARE DISCLAIMED. IN NO EVENT SHALL THE OpenSSL PROJECT OR ITS CONTRIBUTORS BE LIABLE FOR ANY DIRECT, INDIRECT, INCIDENTAL, SPECIAL, EXEMPLARY, OR CONSEQUENTIAL DAMAGES (INCLUDING, BUT NOT LIMITED TO, PROCUREMENT OF SUBSTITUTE GOODS OR SERVICES; LOSS OF USE, DATA, OR PROFITS; OR BUSINESS INTERRUPTION) HOWEVER CAUSED AND ON ANY THEORY OF LIABILITY, WHETHER IN CONTRACT, STRICT LIABILITY, OR TORT (INCLUDING NEGLIGENCE OR OTHERWISE) ARISING IN ANY WAY OUT OF THE USE OF THIS SOFTWARE, EVEN IF ADVISED OF THE POSSIBILITY OF SUCH DAMAGE.

This product includes cryptographic software written by Eric Young

([eay@cryptsoft.com](mailto:eay@cryptsoft.com)). This product includes software written by Tim Hudson ([tjh@cryptsoft.com](mailto:tjh@cryptsoft.com)).

#### Original SSLeay License

-----  
Copyright (C) 1995-1998 Eric Young ([eay@cryptsoft.com](mailto:eay@cryptsoft.com))

All rights reserved.

This package is an SSL implementation written by Eric Young ([eay@cryptsoft.com](mailto:eay@cryptsoft.com)).

The implementation was written so as to conform with Netscapes SSL.

This library is free for commercial and non-commercial use as long as the following conditions are adhered to. The following conditions apply to all code found in this distribution, be it the RC4, RSA, lhash, DES, etc., code; not just the SSL code. The SSL documentation included with this distribution is covered by the same copyright terms except that the holder is Tim Hudson ([tjh@cryptsoft.com](mailto:tjh@cryptsoft.com)).

Copyright remains Eric Young's, and as such any Copyright notices in the code are not to be removed. If this package is used in a product, Eric Young should be given attribution as the author of the parts of the library used. This can be in the form of a textual message at program startup or in documentation (online or textual) provided with the package. Redistribution and use in source and binary forms, with or without modification, are permitted provided that the following conditions are met:

1. Redistributions of source code must retain the copyright notice, this list of conditions and the following disclaimer.
2. Redistributions in binary form must reproduce the above copyright notice, this list of conditions and the following disclaimer in the documentation and/or other materials provided with the distribution.
3. All advertising materials mentioning features or use of this software must display the following acknowledgement:

"This product includes cryptographic software written by Eric Young ([eay@cryptsoft.com](mailto:eay@cryptsoft.com))"

The word 'cryptographic' can be left out if the routines from the library being used are not cryptographic related :-).

4. If you include any Windows specific code (or a derivative thereof) from the apps directory (application code) you must include an acknowledgement:

"This product includes software written by Tim Hudson (tjh@cryptsoft.com)"

HIS SOFTWARE IS PROVIDED BY ERIC YOUNG "AS IS" AND ANY EXPRESS OR IMPLIED WARRANTIES, INCLUDING, BUT NOT LIMITED TO, THE IMPLIED WARRANTIES OF MERCHANTABILITY AND FITNESS FOR A PARTICULAR PURPOSE ARE DISCLAIMED. IN NO EVENT SHALL THE AUTHOR OR CONTRIBUTORS BE LIABLE FOR ANY DIRECT, INDIRECT, INCIDENTAL, SPECIAL, EXEMPLARY, OR CONSEQUENTIAL DAMAGES (INCLUDING, BUT NOT LIMITED TO, PROCUREMENT OF SUBSTITUTE GOODS OR SERVICES; LOSS OF USE, DATA, OR PROFITS; OR BUSINESS INTERRUPTION) HOWEVER CAUSED AND ON ANY THEORY OF LIABILITY, WHETHER IN CONTRACT, STRICT LIABILITY, OR TORT (INCLUDING NEGLIGENCE OR OTHERWISE) ARISING IN ANY WAY OUT OF THE USE OF THIS SOFTWARE, EVEN IF ADVISED OF THE POSSIBILITY OF SUCH DAMAGE. The licence and distribution terms for any publically available version or derivative of this code cannot be changed. i.e. this code cannot simply be copied and put under another distribution licence [including the GNU Public Licence.]

### pcre 5.0

PCRE is a library of functions to support regular expressions whose syntax and semantics are as close as possible to those of the Perl 5 language. Release 5 of PCRE is distributed under the terms of the "BSD" licence, as specified below. The documentation for PCRE, supplied in the "doc" directory, is distributed under the same terms as the software itself.

Written by: Philip Hazel <ph10@cam.ac.uk>

University of Cambridge Computing Service,  
Cambridge, England. Phone: +44 1223 334714.

Copyright (c) 1997-2004 University of Cambridge

All rights reserved.

Redistribution and use in source and binary forms, with or without modification, are permitted provided that the following conditions are met:

- \* Redistributions of source code must retain the above copyright notice, this list of conditions and the following disclaimer.
- \* Redistributions in binary form must reproduce the above copyright notice, this list of conditions and the following disclaimer in the documentation and/or other materials provided with the distribution.
- \* Neither the name of the University of Cambridge nor the names of its contributors may be used to endorse or promote products derived from this software without specific prior written permission.

THIS SOFTWARE IS PROVIDED BY THE COPYRIGHT HOLDERS AND CONTRIBUTORS "AS IS" AND ANY EXPRESS OR IMPLIED WARRANTIES, INCLUDING, BUT NOT LIMITED TO, THE IMPLIED WARRANTIES OF MERCHANTABILITY AND FITNESS FOR A PARTICULAR PURPOSE ARE DISCLAIMED. IN NO EVENT SHALL THE COPYRIGHT OWNER OR CONTRIBUTORS BE LIABLE FOR ANY DIRECT, INDIRECT, INCIDENTAL, SPECIAL, EXEMPLARY, OR CONSEQUENTIAL DAMAGES (INCLUDING, BUT NOT LIMITED TO, PROCUREMENT OF SUBSTITUTE GOODS OR SERVICES; LOSS OF USE, DATA, OR PROFITS; OR BUSINESS INTERRUPTION) HOWEVER CAUSED AND ON ANY THEORY OF LIABILITY, WHETHER IN CONTRACT, STRICT LIABILITY, OR TORT (INCLUDING NEGLIGENCE OR OTHERWISE) ARISING IN ANY WAY OUT OF THE USE OF THIS SOFTWARE, EVEN IF ADVISED OF THE POSSIBILITY OF SUCH DAMAGE.

### PPPD Composite Licenses

Copyright (c) 1984-2000 Carnegie Mellon University. All rights reserved.

Redistribution and use in source and binary forms, with or without modification, are permitted provided that the following conditions are met:

1. Redistributions of source code must retain the above copyright notice, this list of conditions and the following disclaimer.
2. Redistributions in binary form must reproduce the above copyright notice, this list of conditions and the following disclaimer in the documentation and/or other materials provided with the distribution.
3. The name "Carnegie Mellon University" must not be used to endorse or promote products derived from this software without prior written permission. For permission or any legal details, please contact

Office of Technology Transfer  
Carnegie Mellon University  
5000 Forbes Avenue  
Pittsburgh, PA 15213-3890  
(412) 268-4387, fax: (412) 268-7395  
tech-transfer@andrew.cmu.edu

---

4. Redistributions of any form whatsoever must retain the following acknowledgment:

"This product includes software developed by Computing Services at Carnegie Mellon University (<http://www.cmu.edu/computing/>)."

CARNEGIE MELLON UNIVERSITY DISCLAIMS ALL WARRANTIES WITH REGARD TO THIS SOFTWARE, INCLUDING ALL IMPLIED WARRANTIES OF MERCHANTABILITY AND FITNESS, IN NO EVENT SHALL CARNEGIE MELLON UNIVERSITY BE LIABLE FOR ANY SPECIAL, INDIRECT OR CONSEQUENTIAL DAMAGES OR ANY DAMAGES WHATSOEVER RESULTING FROM LOSS OF USE, DATA OR PROFITS, WHETHER IN AN ACTION OF CONTRACT, NEGLIGENCE OR OTHER TORTIOUS ACTION, ARISING OUT OF OR IN CONNECTION WITH THE USE OR PERFORMANCE OF THIS SOFTWARE.

-----  
Copyright (c) 1999-2004 Paul Mackerras. All rights reserved.

Redistribution and use in source and binary forms, with or without modification, are permitted provided that the following conditions are met:

1. Redistributions of source code must retain the above copyright notice, this list of conditions and the following disclaimer.
2. The name(s) of the authors of this software must not be used to endorse or promote products derived from this software without prior written permission.
3. Redistributions of any form whatsoever must retain the following acknowledgment:

"This product includes software developed by Paul Mackerras  
<paulus@samba.org>".

THE AUTHORS OF THIS SOFTWARE DISCLAIM ALL WARRANTIES WITH REGARD TO THIS SOFTWARE, INCLUDING ALL IMPLIED WARRANTIES OF MERCHANTABILITY AND FITNESS, IN NO EVENT SHALL THE AUTHORS BE LIABLE FOR ANY SPECIAL, INDIRECT OR CONSEQUENTIAL DAMAGES OR ANY DAMAGES WHATSOEVER RESULTING FROM LOSS OF USE, DATA OR PROFITS, WHETHER IN AN ACTION OF CONTRACT, NEGLIGENCE OR OTHER TORTIOUS ACTION, ARISING OUT OF OR IN CONNECTION WITH THE USE OR PERFORMANCE OF THIS SOFTWARE.

-----  
Author: Arvin Schnell <arvin@suse.de> . (No copyright, but listed the author for attribution.)

-----  
Copyright (C) 2002 Roaring Penguin Software Inc.

This plugin may be distributed according to the terms of the GNU General Public License, version 2 or (at your option) any later version.

Copyright (C) 2002 Roaring Penguin Software Inc.

Copyright (C) 1996, Matjaz Godec <gody@elgo.si>

Copyright (C) 1996, Lars Fenneberg <in5y050@public.uni-hamburg.de>

Copyright (C) 1997, Miguel A.L. Paraz <map@iphil.net>

Copyright (C) 1995,1996,1997,1998 Lars Fenneberg <lf@elemental.net>

Copyright (C) 2002 Roaring Penguin Software Inc.

MPPE support is by Ralf Hofmann, <ralf.hofmann@elvido.net>, with modification from Frank Cusack, <frank@google.com>.

This plugin may be distributed according to the terms of the GNU General Public License, version 2 or (at your option) any later version.

-----  
Author: Ben McKeegan ben@netservers.co.uk

Copyright (C) 2002 Netservers

This plugin may be distributed according to the terms of the GNU General Public License, version 2 or (at your option) any later version. See the respective source files to find out which copyrights apply.

-----  
Copyright (C) 2002 Roaring Penguin Software Inc.

Permission to use, copy, modify, and distribute this software for any purpose and without fee is hereby granted, provided that this copyright and permission notice appear on all copies and supporting documentation, the name of Roaring Penguin Software Inc. not be used in advertising or publicity pertaining to distribution of the program without specific prior permission, and notice be given in supporting documentation that copying and distribution is by permission of Roaring Penguin Software Inc.. Roaring Penguin Software Inc. makes no representations about the suitability of this software for any purpose. It is provided "as is" without express or implied warranty.

-----  
Copyright (C) 1995,1996,1997,1998 Lars Fenneberg <lf@elemental.net>

Permission to use, copy, modify, and distribute this software for any purpose and without fee is hereby granted, provided that this copyright and permission notice appear on all copies and supporting documentation, the name of Lars Fenneberg not be used in advertising or publicity pertaining to distribution of the program without specific prior permission, and notice be given in supporting documentation that copying and distribution is by permission of Lars Fenneberg. Lars Fenneberg makes no representations about the suitability of this software for any purpose. It is provided "as is" without express or implied warranty.

-----  
Copyright 1992 Livingston Enterprises, Inc.

Livingston Enterprises, Inc. 6920 Koll Center Parkway Pleasanton, CA 94566

Permission to use, copy, modify, and distribute this software for any purpose and without fee is hereby granted, provided that this copyright and permission notice appear on all copies and supporting documentation, the name of Livingston Enterprises, Inc. not be used in advertising or publicity pertaining to distribution of the program without specific prior permission, and notice be given in supporting documentation that copying and distribution is by permission of Livingston Enterprises, Inc. Livingston Enterprises, Inc. makes no representations about the suitability of this software for any purpose. It is provided "as is" without express or implied warranty.

-----  
[C] The Regents of the University of Michigan and Merit Network, Inc. 1992, 1993, 1994, 1995 All Rights Reserved

Permission to use, copy, modify, and distribute this software and its documentation for any purpose and without fee is hereby granted, provided that the above copyright notice and this permission notice appear in all copies of the software and derivative works or modified versions thereof, and that both the copyright notice and this permission and disclaimer notice appear in supporting documentation. THIS SOFTWARE IS PROVIDED "AS IS" WITHOUT WARRANTY OF ANY KIND, EITHER EXPRESS OR IMPLIED, INCLUDING WITHOUT LIMITATION WARRANTIES OF MERCHANTABILITY AND FITNESS FOR A PARTICULAR PURPOSE. THE REGENTS OF THE UNIVERSITY OF MICHIGAN AND MERIT NETWORK, INC. DO NOT WARRANT THAT THE FUNCTIONS CONTAINED IN THE SOFTWARE WILL MEET LICENSEE'S REQUIREMENTS OR THAT OPERATION WILL BE UNINTERRUPTED OR ERROR FREE. The Regents of the University of Michigan and Merit Network, Inc. shall not be liable for any special, indirect, incidental or consequential damages with respect to any claim by Licensee or any third party arising from use of the software.

-----  
Copyright (C) 1990, 1991-2, RSA Data Security, Inc. Created 1991.  
All rights reserved.

---

License to copy and use this software is granted provided that it is identified as the "RSA Data Security, Inc. MD5 Message-Digest Algorithm" in all material mentioning or referencing this software or this function.

License is also granted to make and use derivative works provided that such works are identified as "derived from the RSA Data Security, Inc. MD5 Message-Digest Algorithm" in all material mentioning or referencing the derived work. RSA Data Security, Inc. makes no representations concerning either the merchantability of this software or the suitability of this software for any particular purpose. It is provided "as is" without express or implied warranty of any kind.

These notices must be retained in any copies of any part of this documentation and/or software.

-----  
Copyright (c) 2000 by Sun Microsystems, Inc.  
All rights reserved.

Permission to use, copy, modify, and distribute this software and its documentation is hereby granted, provided that the above copyright notice appears in all copies.

SUN MAKES NO REPRESENTATION OR WARRANTIES ABOUT THE SUITABILITY OF THE SOFTWARE, EITHER EXPRESS OR IMPLIED, INCLUDING BUT NOT LIMITED TO THE IMPLIED WARRANTIES OF MERCHANTABILITY, FITNESS FOR A PARTICULAR PURPOSE, OR NON-INFRINGEMENT. SUN SHALL NOT BE LIABLE FOR ANY DAMAGES SUFFERED BY LICENSEE AS A RESULT OF USING, MODIFYING OR DISTRIBUTING THIS SOFTWARE OR ITS DERIVATIVES

-----  
Copyright (c) 1985, 1986 The Regents of the University of California.  
All rights reserved.

This code is derived from software contributed to Berkeley by James A. Woods, derived from original work by Spencer Thomas and Joseph Orost.

Redistribution and use in source and binary forms, with or without modification, are permitted provided that the following conditions are met:

1. Redistributions of source code must retain the above copyright notice, this list of conditions and the following disclaimer.
2. Redistributions in binary form must reproduce the above copyright notice, this list of conditions and the following disclaimer in the documentation and/or other materials provided with the distribution.
3. All advertising materials mentioning features or use of this software must display the following acknowledgement: This product includes software developed by the University of California, Berkeley and its contributors.
4. Neither the name of the University nor the names of its contributors may be used to endorse or promote products derived from this software without specific prior written permission.

THIS SOFTWARE IS PROVIDED BY THE REGENTS AND CONTRIBUTORS "AS IS" AND ANY EXPRESS OR IMPLIED WARRANTIES, INCLUDING, BUT NOT LIMITED TO, THE IMPLIED WARRANTIES OF MERCHANTABILITY AND FITNESS FOR A PARTICULAR PURPOSE ARE DISCLAIMED. IN NO EVENT SHALL THE REGENTS OR CONTRIBUTORS BE LIABLE FOR ANY DIRECT, INDIRECT, INCIDENTAL, SPECIAL, EXEMPLARY, OR CONSEQUENTIAL DAMAGES (INCLUDING, BUT NOT LIMITED TO, PROCUREMENT OF SUBSTITUTE GOODS OR SERVICES; LOSS OF USE, DATA, OR PROFITS; OR BUSINESS INTERRUPTION) HOWEVER CAUSED AND ON ANY THEORY OF LIABILITY, WHETHER IN CONTRACT, STRICT LIABILITY, OR TORT (INCLUDING NEGLIGENCE OR OTHERWISE) ARISING IN ANY WAY OUT OF THE USE OF THIS SOFTWARE, EVEN IF ADVISED OF THE POSSIBILITY OF SUCH DAMAGE.

Copyright (c) 1989 Regents of the University of California.  
All rights reserved.

Redistribution and use in source and binary forms are permitted provided that the above copyright notice and this paragraph are duplicated in all such forms and that any documentation, advertising materials, and other materials related to such distribution and use acknowledge that the software was developed by the University of California, Berkeley. The name of the University may not be used to endorse or promote products derived from this software without specific prior written permission. THIS SOFTWARE IS PROVIDED "AS IS" AND WITHOUT ANY EXPRESS OR IMPLIED WARRANTIES, INCLUDING, WITHOUT LIMITATION, THE IMPLIED WARRANTIES OF MERCHANTABILITY AND FITNESS FOR A PARTICULAR PURPOSE.

Van Jacobson (van@helios.ee.lbl.gov), Dec 31, 1989:

- Initial distribution.

Modified June 1993 by Paul Mackerras, paulus@cs.anu.edu.au, so that the entire packet being decompressed doesn't have to be in contiguous memory (just the compressed header).

-----  
Copyright 1995-2000 EPFL-LRC/ICA, and are licensed under the GNU Lesser General Public License.  
Written 1995-2000 by Werner Almesberger, EPFL-LRC/ICA \*/

Copyright 2000 Mitchell Blank Jr.  
Based in part on work from Jens Axboe and Paul Mackerras.  
Updated to ppp-2.4.1 by Bernhard Kaindl

Updated to ppp-2.4.2 by David Woodhouse 2004.  
- disconnect method added  
- remove\_options() abuse removed.

This program is free software; you can redistribute it and/or modify it under the terms of the GNU General Public License as published by the Free Software Foundation; either version 2 of the License, or (at your option) any later version.

-----  
Copyright (C) 1995 Jean-loup Gailly and Mark Adler

This software is provided 'as-is', without any express or implied warranty. In no event will the authors be held liable for any damages arising from the use of this software. Permission is granted to anyone to use this software for any purpose, including commercial applications, and to alter it and redistribute it freely, subject to the following restrictions: 1. The origin of this software must not be misrepresented; you must not claim that you wrote the original software. If you use this software in a product, an acknowledgment in the product documentation would be appreciated but is not required. 2. Altered source versions must be plainly marked as such, and must not be misrepresented as being the original software. 3. This notice may not be removed or altered from any source distribution.

Jean-loup Gailly Mark Adler  
gzip@prep.ai.mit.edu madler@alumni.caltech.edu

-----  
Copyright (C) 2003 Andrew Bartlet <abartlet@samba.org>  
Copyright 1999 Paul Mackerras, Alan Curry.  
Copyright (C) 2002 Roaring Penguin Software Inc.  
Copyright (C) 1996, Matjaz Godec <gody@elgo.si>  
Copyright (C) 1996, Lars Fenneberg <in5y050@public.uni-hamburg.de>  
Copyright (C) 1997, Miguel A.L. Paraz <map@iphil.net>  
Copyright (C) 1995,1996,1997,1998 Lars Fenneberg <lf@elemental.net>  
Copyright (C) 2002 Roaring Penguin Software Inc.  
Copyright (C) 2003, Sean E. Millichamp <sean at bruenor dot org>

This plugin may be distributed according to the terms of the GNU General Public License, version 2 or (at your option) any later version.



---

-----  
Copyright (C) 2000 by Roaring Penguin Software Inc.

This program may be distributed according to the terms of the GNU General Public License, version 2 or (at your option) any later version.

-----  
Copyright (C) 2000-2001 by Roaring Penguin Software Inc.  
Copyright (C) 2004 Marco d'Itri <md@linux.it>

This program may be distributed according to the terms of the GNU General Public License, version 2 or (at your option) any later version.

-----  
Copyright (c) 2001 by Sun Microsystems, Inc.  
All rights reserved.

Non-exclusive rights to redistribute, modify, translate, and use this software in source and binary forms, in whole or in part, is hereby granted, provided that the above copyright notice is duplicated in any source form, and that neither the name of the copyright holder nor the author is used to endorse or promote products derived from this software.

THIS SOFTWARE IS PROVIDED "AS IS" AND WITHOUT ANY EXPRESS OR IMPLIED WARRANTIES, INCLUDING, WITHOUT LIMITATION, THE IMPLIED WARRANTIES OF MERCHANTABILITY AND FITNESS FOR A PARTICULAR PURPOSE.

Original version by James Carlson

-----  
Copyright (c) 2002 Google, Inc.  
All rights reserved.

Redistribution and use in source and binary forms, with or without modification, are permitted provided that the following conditions are met:

1. Redistributions of source code must retain the above copyright notice, this list of conditions and the following disclaimer.
2. Redistributions in binary form must reproduce the above copyright notice, this list of conditions and the following disclaimer in the documentation and/or other materials provided with the distribution.
3. The name(s) of the authors of this software must not be used to endorse or promote products derived from this software without prior written permission.

THE AUTHORS OF THIS SOFTWARE DISCLAIM ALL WARRANTIES WITH REGARD TO THIS SOFTWARE, INCLUDING ALL IMPLIED WARRANTIES OF MERCHANTABILITY AND FITNESS, IN NO EVENT SHALL THE AUTHORS BE LIABLE FOR ANY SPECIAL, INDIRECT OR CONSEQUENTIAL DAMAGES OR ANY DAMAGES WHATSOEVER RESULTING FROM LOSS OF USE, DATA OR PROFITS, WHETHER IN AN ACTION OF CONTRACT, NEGLIGENCE OR OTHER TORTIOUS ACTION, ARISING OUT OF OR IN CONNECTION WITH THE USE OR PERFORMANCE OF THIS SOFTWARE.

-----  
Copyright (c) 1999 Tommi Komulainen. All rights reserved.

Redistribution and use in source and binary forms, with or without modification, are permitted provided that the following conditions are met:

1. Redistributions of source code must retain the above copyright notice, this list of conditions and the following disclaimer.
2. Redistributions in binary form must reproduce the above copyright notice, this list of conditions and the following disclaimer in the documentation and/or other materials provided with the distribution.
3. The name(s) of the authors of this software must not be used to endorse or promote products derived from this software without prior written permission.
4. Redistributions of any form whatsoever must retain the following acknowledgment:

"This product includes software developed by Tommi Komulainen  
<Tommi.Komulainen@iki.fi>".

THE AUTHORS OF THIS SOFTWARE DISCLAIM ALL WARRANTIES WITH REGARD TO THIS SOFTWARE, INCLUDING ALL IMPLIED WARRANTIES OF MERCHANTABILITY AND FITNESS, IN NO EVENT SHALL THE AUTHORS BE LIABLE FOR ANY SPECIAL, INDIRECT OR CONSEQUENTIAL DAMAGES OR ANY DAMAGES WHATSOEVER RESULTING FROM LOSS OF USE, DATA OR PROFITS, WHETHER IN AN ACTION OF CONTRACT, NEGLIGENCE OR OTHER TORTIOUS ACTION, ARISING OUT OF OR IN CONNECTION WITH THE USE OR PERFORMANCE OF THIS SOFTWARE.

Original version, based on RFC2023 :

Copyright (c) 1995, 1996, 1997 Francis.Dupont@inria.fr, INRIA Rocquencourt,  
Alain.Durand@imag.fr, IMAG,  
Jean-Luc.Richier@imag.fr, IMAG-LSR.

Copyright (c) 1998, 1999 Francis.Dupont@inria.fr, GIE DYADE,  
Alain.Durand@imag.fr, IMAG,  
Jean-Luc.Richier@imag.fr, IMAG-LSR.

Ce travail a été fait au sein du GIE DYADE (Groupement d'Intérêt Économique ayant pour membres BULL S.A. et l'INRIA). Ce logiciel informatique est disponible aux conditions usuelles dans la recherche, c'est-à-dire qu'il peut être utilisé, copié, modifié, distribué à l'unique condition que ce texte soit conservé afin que l'origine de ce logiciel soit reconnue. Le nom de l'Institut National de Recherche en Informatique et en Automatique (INRIA), de l'IMAG, ou d'une personne morale ou physique ayant participé à l'élaboration de ce logiciel ne peut être utilisé sans son accord préalable explicite. Ce logiciel est fourni tel quel sans aucune garantie, support ou responsabilité d'aucune sorte. Ce logiciel est dérivé de sources d'origine "University of California at Berkeley" et "Digital Equipment Corporation" couvertes par des copyrights. L'Institut d'Informatique et de Mathématiques Appliquées de Grenoble (IMAG) est une fédération d'unités mixtes de recherche du CNRS, de l'Institut National Polytechnique de Grenoble et de l'Université Joseph Fourier regroupant sept laboratoires dont le laboratoire Logiciels, Systèmes, Réseaux (LSR).

This work has been done in the context of GIE DYADE (joint R & D venture between BULL S.A. and INRIA). This software is available with usual "research" terms with the aim of retain credits of the software. Permission to use, copy, modify and distribute this software for any purpose and without fee is hereby granted, provided that the above copyright notice and this permission notice appear in all copies, and the name of INRIA, IMAG, or any contributor not be used in advertising or publicity pertaining to this material without the prior explicit permission. The software is provided "as is" without any warranties, support or liabilities of any kind. This software is derived from source code from "University of California at Berkeley" and "Digital Equipment Corporation" protected by copyrights. Grenoble's Institute of Computer Science and Applied Mathematics (IMAG) is a federation of seven research units funded by the CNRS, National Polytechnic Institute of Grenoble and University Joseph Fourier. The research unit in Software, Systems, Networks (LSR) is member of IMAG.

-----  
Copyright (c) 1995 Eric Rosenquist. All rights reserved.

Redistribution and use in source and binary forms, with or without modification, are permitted provided that the following conditions are met:

1. Redistributions of source code must retain the above copyright notice, this list of conditions and the following disclaimer.
2. Redistributions in binary form must reproduce the above copyright notice, this list of conditions and the following disclaimer in the documentation and/or other materials provided with the distribution.
3. The name(s) of the authors of this software must not be used to endorse or promote products derived from this software without prior written permission.

---

THE AUTHORS OF THIS SOFTWARE DISCLAIM ALL WARRANTIES WITH REGARD TO THIS SOFTWARE, INCLUDING ALL IMPLIED WARRANTIES OF MERCHANTABILITY AND FITNESS, IN NO EVENT SHALL THE AUTHORS BE LIABLE FOR ANY SPECIAL, INDIRECT OR CONSEQUENTIAL DAMAGES OR ANY DAMAGES WHATSOEVER RESULTING FROM LOSS OF USE, DATA OR PROFITS, WHETHER IN AN ACTION OF CONTRACT, NEGLIGENCE OR OTHER TORTIOUS ACTION, ARISING OUT OF OR IN CONNECTION WITH THE USE OR PERFORMANCE OF THIS SOFTWARE.

---

Copyright (C) Andrew Tridgell 1999-2004

Copyright (C) Anton Blanchard 2001

Copyright (C) Paul 'Rusty' Russell 2000

Copyright (C) Jeremy Allison 2000-2003

\*\* NOTE! The following LGPL license applies to the tdb library. This does NOT imply that all of Samba is released under the LGPL

This library is free software; you can redistribute it and/or modify it under the terms of the GNU Lesser General Public License as published by the Free Software Foundation; either version 2 of the License, or (at your option) any later version. This library is distributed in the hope that it will be useful, but WITHOUT ANY WARRANTY; without even the implied warranty of MERCHANTABILITY or FITNESS FOR A PARTICULAR PURPOSE. See the GNU Lesser General Public License for more details.

You should have received a copy of the GNU Lesser General Public License along with this library; if not, write to the Free Software Foundation, Inc., 59 Temple Place, Suite 330, Boston, MA 02111-1307 USA

## radvd 1.8.3

radvd license

The author(s) grant permission for redistribution and use in source and binary forms, with or without modification, of the software and documentation provided that the following conditions are met:

0. If you receive a version of the software that is specifically labelled as not being for redistribution (check the version message and/or README), you are not permitted to redistribute that version of the software in any way or form.
1. All terms of all other applicable copyrights and licenses must be followed.
2. Redistributions of source code must retain the authors' copyright notice(s), this list of conditions, and the following disclaimer.
3. Redistributions in binary form must reproduce the authors' copyright notice(s), this list of conditions, and the following disclaimer in the documentation and/or other materials provided with the distribution.
4. All advertising materials mentioning features or use of this software must display the following acknowledgement with the name(s) of the authors as specified in the copyright notice(s) substituted where indicated: This product includes software developed by the authors which are mentioned at the start of the source files and other contributors.
5. Neither the name(s) of the author(s) nor the names of its contributors may be used to endorse or promote products derived from this software without specific prior written permission.

THIS SOFTWARE IS PROVIDED BY ITS AUTHORS AND CONTRIBUTORS ``AS IS'' AND ANY EXPRESS OR IMPLIED WARRANTIES, INCLUDING, BUT NOT LIMITED TO, THE IMPLIED WARRANTIES OF MERCHANTABILITY AND FITNESS FOR A PARTICULAR PURPOSE ARE DISCLAIMED. IN NO EVENT SHALL THE AUTHORS OR CONTRIBUTORS BE LIABLE FOR ANY DIRECT, INDIRECT, INCIDENTAL, SPECIAL, EXEMPLARY, OR CONSEQUENTIAL DAMAGES (INCLUDING, BUT NOT LIMITED TO, PROCUREMENT OF SUBSTITUTE GOODS OR SERVICES; LOSS OF USE, DATA, OR PROFITS; OR BUSINESS INTERRUPTION) HOWEVER CAUSED AND ON ANY THEORY OF LIABILITY, WHETHER IN CONTRACT, STRICT LIABILITY, OR TORT (INCLUDING NEGLIGENCE OR OTHERWISE) ARISING IN ANY WAY OUT OF THE USE OF THIS SOFTWARE, EVEN IF ADVISED OF THE POSSIBILITY OF SUCH DAMAGE.

## SimCList Component

Copyright (c) 2007,2008 Mij

## Dropbear - a SSH2 server 0.52

Copyright (c) 2002-2008 Matt Johnston

Portions copyright (c) 2004 Mihnea Stoenescu

All rights reserved.

Permission is hereby granted, free of charge, to any person obtaining a copy of this software and associated documentation files (the "Software"), to deal in the Software without restriction, including without limitation the rights to use, copy, modify, merge, publish, distribute, sublicense, and/or sell copies of the Software, and to permit persons to whom the Software is furnished to do so, subject to the following conditions: The above copyright notice and this permission notice shall be included in all copies or substantial portions of the Software.

THE SOFTWARE IS PROVIDED "AS IS", WITHOUT WARRANTY OF ANY KIND, EXPRESS OR IMPLIED, INCLUDING BUT NOT LIMITED TO THE WARRANTIES OF MERCHANTABILITY, FITNESS FOR A PARTICULAR PURPOSE AND NONINFRINGEMENT. IN NO EVENT SHALL THE AUTHORS OR COPYRIGHT HOLDERS BE LIABLE FOR ANY CLAIM, DAMAGES OR OTHER LIABILITY, WHETHER IN AN ACTION OF CONTRACT, TORT OR OTHERWISE, ARISING FROM, OUT OF OR IN CONNECTION WITH THE SOFTWARE OR THE USE OR OTHER DEALINGS IN THE SOFTWARE.

=====

### **LibTomCrypt and LibTomMath are written by Tom St Denis, and are Public Domain.**

=====

### **sshpty.c is taken from OpenSSH 3.5p1,**

Copyright (c) 1995 Tatu Ylonen <ylo@cs.hut.fi>, Timo Rinne <tri@iki.fi>, Espoo, Finland  
All rights reserved

"As far as I am concerned, the code I have written for this software can be used freely for any purpose. Any derived versions of this software must be clearly marked as such, and if the derived work is incompatible with the protocol description in the RFC file, it must be called by a name other than "ssh" or "Secure Shell". "

=====

### **loginrec.c is written primarily by Andre Lucas, Jason Downs, Theo de Raadt:**

Copyright (c) 2000 Andre Lucas.  
Portions copyright (c) 1998 Todd C. Miller  
Portions copyright (c) 1996 Jason Downs  
Portions Copyright (c) 1996 Theo de Raadt.

### **loginrec.h is written by Andre Lucas:**

Copyright (c) 2000 Andre Lucas.

### **atomicio.h,atomicio.c written by Theo de Raadt (1995-1999)**

Copyright (c) 1995,1999 Theo de Raadt.

And are licensed under the following terms:

Copyright (c) <YEAR>, <OWNER>

All rights reserved.

Redistribution and use in source and binary forms, with or without modification, are permitted provided that the following conditions are met: Redistributions of source code must retain the above copyright notice, this list of conditions and the following disclaimer.

Redistributions in binary form must reproduce the above copyright notice, this list of conditions and the following disclaimer in the documentation and/or other materials provided with the distribution.

THIS SOFTWARE IS PROVIDED BY THE COPYRIGHT HOLDERS AND CONTRIBUTORS "AS IS" AND ANY EXPRESS OR IMPLIED WARRANTIES, INCLUDING, BUT NOT LIMITED TO, THE IMPLIED WARRANTIES OF MERCHANTABILITY AND FITNESS FOR A PARTICULAR PURPOSE ARE DISCLAIMED. IN NO EVENT SHALL THE COPYRIGHT HOLDER OR CONTRIBUTORS BE LIABLE FOR ANY DIRECT, INDIRECT, INCIDENTAL, SPECIAL, EXEMPLARY, OR CONSEQUENTIAL DAMAGES (INCLUDING, BUT NOT LIMITED TO, PROCUREMENT OF SUBSTITUTE GOODS OR SERVICES; LOSS OF USE, DATA, OR PROFITS; OR BUSINESS INTERRUPTION) HOWEVER CAUSED AND ON ANY THEORY OF LIABILITY, WHETHER IN CONTRACT, STRICT LIABILITY, OR TORT (INCLUDING NEGLIGENCE OR OTHERWISE) ARISING IN ANY WAY OUT OF THE USE OF THIS SOFTWARE, EVEN IF ADVISED OF THE POSSIBILITY OF SUCH DAMAGE.

=====

---

**strlcat() is (c) Todd C. Miller (included in util.c -- ) are from OpenSSH 3.6.1p2, and are licensed under the BSD-Modified license:**

Copyright (c) 1998 Todd C. Miller , < OWNER > All rights reserved.

Redistribution and use in source and binary forms, with or without modification, are permitted provided that the following conditions are met: Redistributions of source code must retain the above copyright notice, this list of conditions and the following disclaimer. Redistributions in binary form must reproduce the above copyright notice, this list of conditions and the following disclaimer in the documentation and/or other materials provided with the distribution. Neither the name of the < ORGANIZATION > nor the names of its contributors may be used to endorse or promote products derived from this software without specific prior written permission. THIS SOFTWARE IS PROVIDED BY THE COPYRIGHT HOLDERS AND CONTRIBUTORS "AS IS" AND ANY EXPRESS OR IMPLIED WARRANTIES, INCLUDING, BUT NOT LIMITED TO, THE IMPLIED WARRANTIES OF MERCHANTABILITY AND FITNESS FOR A PARTICULAR PURPOSE ARE DISCLAIMED. IN NO EVENT SHALL THE COPYRIGHT OWNER OR CONTRIBUTORS BE LIABLE FOR ANY DIRECT, INDIRECT, INCIDENTAL, SPECIAL, EXEMPLARY, OR CONSEQUENTIAL DAMAGES (INCLUDING, BUT NOT LIMITED TO, PROCUREMENT OF SUBSTITUTE GOODS OR SERVICES; LOSS OF USE, DATA, OR PROFITS; OR BUSINESS INTERRUPTION) HOWEVER CAUSED AND ON ANY THEORY OF LIABILITY, WHETHER IN CONTRACT, STRICT LIABILITY, OR TORT (INCLUDING NEGLIGENCE OR OTHERWISE) ARISING IN ANY WAY OUT OF THE USE OF THIS SOFTWARE, EVEN IF ADVISED OF THE POSSIBILITY OF SUCH DAMAGE.

=====

Import code in keyimport.c is modified from PuTTY's import.c, licensed as follows:

PuTTY is copyright 1997-2003 Simon Tatham.

Portions copyright Robert de Bath, Joris van Rantwijk, Delian Delchev, Andreas Schultz, Jeroen Massar, Wez Furlong, Nicolas Barry, Justin Bradford, and CORE SDI S.A.

Permission is hereby granted, free of charge, to any person obtaining a copy of this software and associated documentation files (the "Software"), to deal in the Software without restriction, including without limitation the rights to use, copy, modify, merge, publish, distribute, sublicense, and/or sell copies of the Software, and to permit persons to whom the Software is furnished to do so, subject to the following conditions: The above copyright notice and this permission notice shall be included in all copies or substantial portions of the Software.

THE SOFTWARE IS PROVIDED "AS IS", WITHOUT WARRANTY OF ANY KIND, EXPRESS OR IMPLIED, INCLUDING BUT NOT LIMITED TO THE WARRANTIES OF MERCHANTABILITY, FITNESS FOR A PARTICULAR PURPOSE AND NONINFRINGEMENT. IN NO EVENT SHALL THE COPYRIGHT HOLDERS BE LIABLE FOR ANY CLAIM, DAMAGES OR OTHER LIABILITY, WHETHER IN AN ACTION OF CONTRACT, TORT OR OTHERWISE, ARISING FROM, OUT OF OR IN CONNECTION WITH THE SOFTWARE OR THE USE OR OTHER DEALINGS IN THE SOFTWARE.

## WIDE-DHCPv6

Copyright (C) 2002 WIDE Project.

All rights reserved.

Redistribution and use in source and binary forms, with or without modification, are permitted provided that the following conditions are met:

1. Redistributions of source code must retain the above copyright notice, this list of conditions and the following disclaimer.
2. Redistributions in binary form must reproduce the above copyright notice, this list of conditions and the following disclaimer in the documentation and/or other materials provided with the distribution.
3. Neither the name of the project nor the names of its contributors may be used to endorse or promote products derived from this software without specific prior written permission.

THIS SOFTWARE IS PROVIDED BY THE PROJECT AND CONTRIBUTORS ``AS IS" AND ANY EXPRESS OR IMPLIED WARRANTIES, INCLUDING, BUT NOT LIMITED TO, THE IMPLIED WARRANTIES OF MERCHANTABILITY AND FITNESS FOR A PARTICULAR PURPOSE ARE DISCLAIMED. IN NO EVENT SHALL THE PROJECT OR CONTRIBUTORS BE LIABLE FOR ANY DIRECT, INDIRECT, INCIDENTAL, SPECIAL, EXEMPLARY, OR CONSEQUENTIAL DAMAGES (INCLUDING, BUT NOT LIMITED TO, PROCUREMENT OF SUBSTITUTE GOODS OR SERVICES; LOSS OF USE, DATA, OR PROFITS; OR BUSINESS INTERRUPTION) HOWEVER CAUSED AND ON ANY THEORY OF LIABILITY, WHETHER IN CONTRACT, STRICT LIABILITY, OR TORT (INCLUDING NEGLIGENCE OR OTHERWISE) ARISING IN ANY WAY OUT OF THE USE OF THIS SOFTWARE, EVEN IF ADVISED OF THE POSSIBILITY OF SUCH DAMAGE.

Copyright (C)2000 YOSHIFUJI Hideaki

Copyright (c) 1995, 1999 Berkeley Software Design, Inc.

**zlib 1.2.3**

Copyright (C) 1995-2005 Jean-loup Gailly and Mark Adler

This software is provided 'as-is', without any express or implied warranty. In no event will the authors be held liable for any damages arising from the use of this software. Permission is granted to anyone to use this software for any purpose, including commercial applications, and to alter it and redistribute it freely, subject to the following restrictions:

1. The origin of this software must not be misrepresented; you must not claim that you wrote the original software. If you use this software in a product, an acknowledgment in the product documentation would be appreciated but is not required.
2. Altered source versions must be plainly marked as such, and must not be misrepresented as being the original software.
3. This notice may not be removed or altered from any source distribution.

Copyright (c) Mark Adler

Portions Copyright ARRIS Group, Inc. 2009-2012

Portions Copyright Broadcom Corporation

Portions Copyright AltoCom, Inc.

---

## **Appendix A      ARRIS Gateway Captive Portal Implementation**

This section contains information about the ARRIS Gateway Captive Portal Support.

## Overview

ARRIS follows the 2Wire RPC specification for implementation of Captive Portal.

The Captive Portal feature redirects all TCP traffic destined to port 80 and redirects it to a Captive Portal URL. A White-IP address list can be configured to avoid the captive portal redirect. All HTTP traffic destined to the IP addresses within this white IP address list will not be redirected to the Captive Portal. Any Changes to the Captive Portal parameters will take place immediately and do not require a reboot.

- ◆ PortalURL can be a maximum of 512 characters long.
- ◆ A maximum of 500 White-IP addresses are supported. The White-IP address list takes a comma-separated string, which can be Individual IP addresses or a range of IP addresses. For a range of IP addresses, a subnet mask is required.
- ◆ The following formats of IP address are accepted:
  - Individual IP address - 144.130.120.62 or 144.130.120.62/32
  - Range of 64 IP addresses - 144.130.120.64/26
- ◆ The White-IP address list gets rewritten on any changes.
- ◆ Clearing the Captive Portal URL disables Captive Portal. Turning off the enable parameter can also disable Captive Portal functionality.
- ◆ Captive Portal is **disabled by default and enabled via TR-069**
- ◆ The white list can be a combination of FQDN (fully qualified domain names) and White-IP address/CIDR.
- ◆ FQDNs will be resolved to IP addresses on boot and whenever a new list is pushed.
- ◆ For the NVG599, Captive Portal implementation only redirects port 80 traffic. Traffic to port 443 is allowed.
- ◆ DNS Traffic will not be blocked.



---

## Captive Portal RPC

RPC supported per 2Wire requirements that will set Captive Portal parameters.

```
<xs:schema xmlns:xs="http://www.w3.org/2001/XMLSchema"
  xmlns:soapenv="http://schemas.xmlsoap.org/soap/envelope/"
  xmlns:soapenc="http://schemas.xmlsoap.org/soap/encoding/"
  xmlns:tns="urn:dslforum-org:cwmp-1-0"
  targetNamespace="urn:dslforum-org:cwmp-1-0"
  elementFormDefault="unqualified"
  attributeFormDefault="unqualified">
  <xs:import namespace="http://schemas.xmlsoap.org/soap/envelope/"
    schemaLocation="soapenv.xsd"/>
  <xs:import namespace="http://schemas.xmlsoap.org/soap/encoding/"
    schemaLocation="soapenc.xsd"/>

  <xs:complexType name="CaptivePortalParamStruct">
    <xs:sequence>
      <xs:element name="Enable" type="soapenc:boolean">
        <xs:annotation>
          <xs:documentation>If true, the Captive Portal is enabled.<
xs:documentation>
          <xs:documentation>If false, the Captive Portal is
disabled.</xs:documentation>
        </xs:annotation>
      </xs:element>
      <xs:element name="RedirectURL">
        <xs:annotation>
          <xs:documentation>the URL to be redirected to.<
xs:documentation>
        </xs:annotation>
        <xs:simpleType>
          <xs:restriction base="xs:string">
            <xs:maxLength value="512"/>
          </xs:restriction>
        </xs:simpleType>
      </xs:element>
      <xs:element name="WhiteList" type="tns:WhiteList">
        <xs:annotation>
          <xs:documentation>a list of sites and IP address to be
escaped by the Captive Portal.</xs:documentation>
        </xs:annotation>
      </xs:element>
    </xs:sequence>
  </xs:complexType>
```

### X\_00D09E\_GetCaptivePortalParams RPC:

```
<!-- X_00D09E_GetCaptivePortalParams -->
  <xs:element name="X_00D09E_GetCaptivePortalParams">
    <xs:annotation>
      <xs:documentation>X_00D09E_GetCaptivePortalParams message is
to get the Captive Portal parameters on a CPE.</xs:documentation>
    </xs:annotation>
    <xs:complexType/>
  </xs:element>
```

```
<!-- X_00D09E_GetCaptivePortalParamsResponse -->
  <xs:element name="X_00D09E_GetCaptivePortalParamsResponse">
    <xs:annotation>
      <xs:documentation>X_00D09E_GetCaptivePortalParamsResponse
response message for X_00D09E_GetCaptivePortalParams request.<
xs:documentation>
    </xs:annotation>
    <xs:complexType>
      <xs:sequence>
        <xs:element name="CaptivePortalParamStruct"
type="tns:CaptivePortalParamStruct"/>
      </xs:sequence>
    </xs:complexType>
  </xs:element>
```

### **X\_00D09E\_SetCaptivePortalParams RPC:**

```
<!-- X_00D09E_SetCaptivePortalParams -->
  <xs:element name="X_00D09E_SetCaptivePortalParams">
    <xs:annotation>
      <xs:documentation>X_00D09E_SetCaptivePortalParams message to
set the Captive Portal parameters on a CPE.</xs:documentation>
    </xs:annotation>
    <xs:complexType>
      <xs:sequence>
        <xs:element name="CaptivePortalParamStruct"
type="tns:CaptivePortalParamStruct"/>
      </xs:sequence>
    </xs:complexType>
  </xs:element>

<!-- X_00D09E_SetCaptivePortalParamsResponse -->
  <xs:element name="X_00D09E_SetCaptivePortalParamsResponse">
    <xs:annotation>
      <xs:documentation>X_00D09E_SetCaptivePortalParamsResponse
response message is a response for X_00D09E_SetCaptivePortalParams
request.</xs:documentation>
    </xs:annotation>
    <xs:complexType/>
  </xs:element>
```

---

## **Appendix B      Quality of Service (QoS) Examples**

This section contains information about the ARRIS Gateway QoS implementation.

## Overview

When packets arrive on a high speed interface and are forwarded to a low speed interface, there is contention for bandwidth. This is the use case for QoS: to make effective use of bandwidth.

The basic steps for Quality of Service are to match and identify packets as belonging to a class of traffic, and to give each class of traffic a certain behavior such as priority queuing or bandwidth shaping across critical networking bottlenecks.

Packets forwarded through the system are classified using sets of filter rules to match various criteria, for example p-bit, IP address, port, etc. The matching rule can set the classification, which is the name of the queue that is to be used.

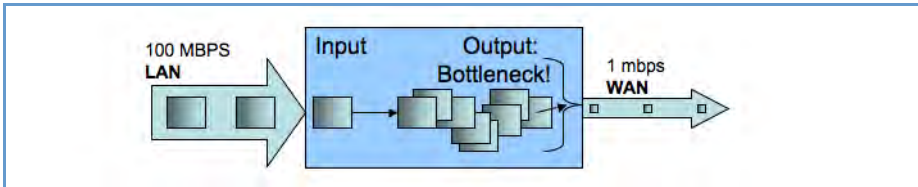

Figure 1. Illustration of upstream congestion, all traffic is consistently delayed.

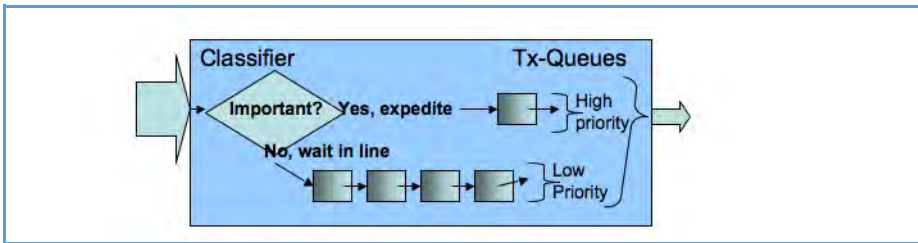

Figure 2. Illustration of classification and transmit queue in a simple high/low priority scheme. Low priority may transmit only when high priority is completely empty.

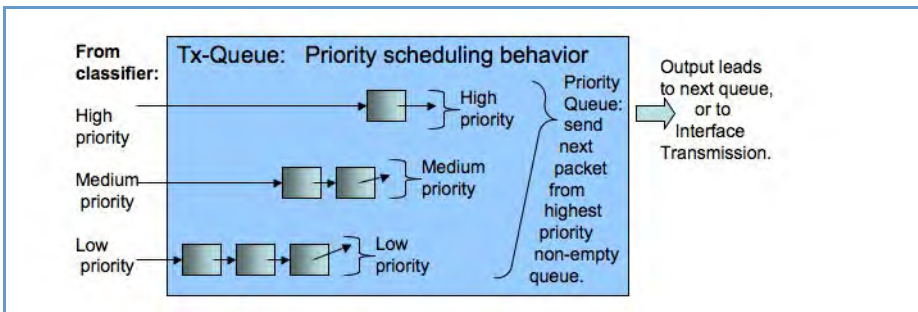

Figure 3. Illustration of priority scheduling

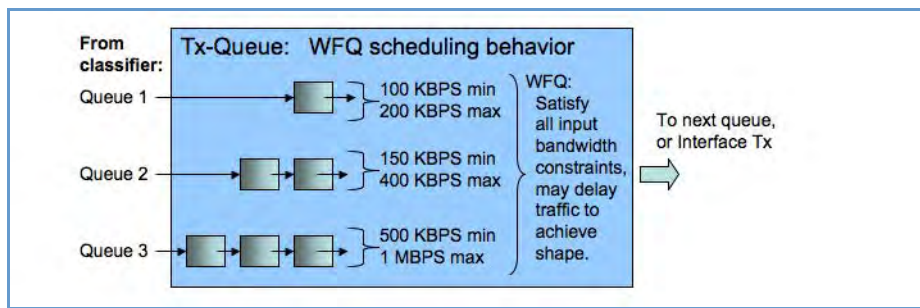

Figure 4. Illustration of weighted fair queue scheduling

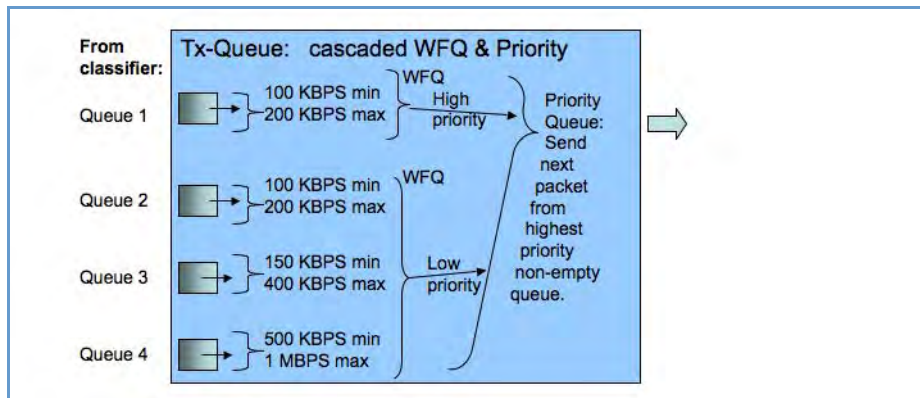

Figure 5. Illustration of a hybrid queue that is both priority and WFQ, to both constrain bandwidth usage and expedite one of the queues.

After the packet has been classified, it can be put in the proper queue. Queues are assigned to interfaces and can be constructed of several queue components to deliver the desired behavior. The components of an interface queue are these building blocks:

- ◆ **basic queues:** a 1 input 1 output packet list with a length of 64 packets by default. Packets will tail-drop when the enqueued to a full basic queue.
- ◆ **priority queue:** 2 or more input, 1 output. Schedules the packets from the various inputs strictly according to input's priority.
- ◆ **weighted fair queue:** 1 or more input, 1 output. Schedules the packets according to bandwidth constraints

Packets are enqueued to basic queues, and only to basic queues. Basic queues are output to priority queues and weighted fair queues, which act as “plumbing” elements that alter the dequeuing order and rate, respectively. Priority queues and weighted fair queues can contain one another.

Weighted fair queues are used to constrain bandwidth. For example, consider a weighted fair queue with three basic queues as inputs, EF, AF and BE:

```
WFQ
Input 1: EF
Input 2: AF
Input 3: BE
```

Each input entry is configured with a weight value, which is the rate at which to limit the traffic. This weight can be either absolute (bps) or a relative percentage of the interface's data-rate. This allows dedicating a split amount of bandwidth to each queue. A special value for the weight parameter is zero, which will use the remainder of unclaimed bandwidth.

There is an option to enable bandwidth sharing, so that unused bandwidth in idle queues can be shared to other queues. When the traffic resumes in the previously idle queue, the previously shared-out bandwidth is taken back.

When bandwidth sharing is enabled, a secondary rate configuration appears on each input entry, the peak parameter. This is a hard limit on the amount of bandwidth that the particular input entry can use. This rate will not be exceeded, even if there is an excess pool of idle bandwidth that could otherwise be shared.

## Upstream QoS: Priority and Shaping

The gateway uses the DSL sync rate to determine traffic shaping requirements for WAN traffic. In this case there are 6 basic queues, and a hierarchy of both priority queue and weighted fair queue (WFQ) with bandwidth sharing and dual rate shaping. First the packets are classified via the filterset, to set the QoS-marker with the name of the desired basic queues. The queues are shown here, with packets traveling from left to right. Each basic queue feeds into a WFQ entry, and is shaped between the minimum bandwidth defined by **weight**, and the maximum rate defined by **peak**. If there is sufficient bandwidth, the WFQ entry shapes at the **peak** rate. If there is no spare bandwidth available for sharing, then the queue is shaped at the **weight** rate. The **weight** rate is defined either as a bps value, or as a percentage of line-rate that is determined once the upstream WAN data-rate is acquired. This **weight** value behaves as a committed information rate (CIR), and the **peak** value behaves as a peak information rate (PIR.)

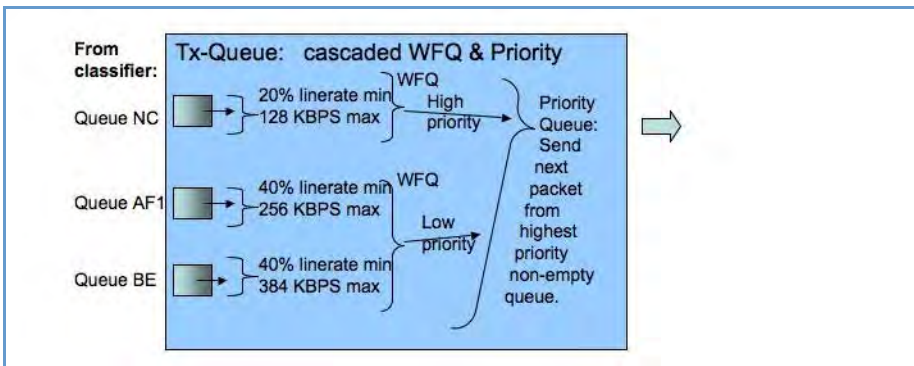

Figure 6. Illustration of default queues used for AT&T

```
Packet Rx > Filterset Rules:
```

```
Match Rule 1? Set QoS marker = EF
Match Rule 2? Set QoS marker = AF1
Match Rule 3? Set QoS marker = BE
```

```
EF CIR/PIR -> wfq_hi -> PQ1 \
AF4 CIR/PIR \ > PQ output to interface Tx
AF3 CIR/PIR \ /
AF2 CIR/PIR > wfq_lo > PQ2 /
AF1 CIR/PIR /
BE CIR/PIR /
```

---

## Downstream QoS: Ethernet Switch

The simplest way of handling downstream QoS (from WAN to LAN) is to use the per-port queues that are present in the Ethernet switch. This achieves the greatest efficiency since the queues are handled in the switch hardware, and should be used when a strict priority queue with 4 priorities is sufficient.

The traffic is classified by priority-bit value. This can be the value retained from WAN ingress (assuming WAN is tagged,) or it can be a value that is set via a filter rule, which allows for advanced classification criteria to be used. Even though the LAN interface might not be tagged, there is still an internal priority field which is used to convey this information to the switch.

## Downstream QoS: Egress queues

The secondary method of downstream QoS is to assign egress queues to the LAN port configuration. This is less efficient, however it allows more advanced queue scheduling algorithms to be used. Packets are classified by QoS markers set by filter rules.



**NOTE:**

This method is typically not recommended for deployment configuration as this mechanism can consume a large amount of CPU processing bandwidth.

---





---

## Index

### Symbols

!! command [106](#)

### A

Access Code [30](#)

Address resolution table [113](#)

Administrator password [105](#)

Arguments, CLI [118](#)

ARP

    Command [107](#), [116](#)

### B

basic queues [219](#)

Broadband Network Redirect [22](#)

Broadband Status [34](#)

Broadband Status Notification [84](#)

### C

Call Statistics [56](#)

Captive Portal [213](#)

CLI [101](#)

    !! command [106](#)

    Arguments [118](#)

    Command shortcuts [106](#)

    Command truncation [118](#)

    Configuration mode [118](#)

    Keywords [118](#)

    Navigating [118](#)

    Prompt [106](#), [118](#)

    Restart command [106](#)

    SHELL mode [106](#)

    View command [119](#)

Command

    ARP [107](#), [116](#)

    Ping [108](#)

    Telnet [115](#)

Command line interface (see CLI)

CONFIG

    Command List [104](#)

Configuration mode [118](#)

Connection commands [121](#)

Custom Service [68](#)

### D

Default Server [74](#)

designing a new filter set [61](#)

Device Access Code [24](#)

Device List [28](#)

DHCP lease table [109](#)

Diagnostic log [109](#), [114](#)

Diagnostics [77](#)

Documentation conventions [8](#)

Downstream QoS [221](#)

### E

Ethernet statistics [109](#)

Event Notifications [84](#)

### F

filter

    parts [61](#)

    parts of [61](#)

filter sets

    using [62](#)

filters

    using [61](#), [62](#)

firewall [113](#)

Firewall Advanced [75](#)

Firewall Status [59](#)

### G

Global Filterset [128](#)

### H

Help [27](#)

Home Network [39](#)

HPNA [52](#)

HPNA Configure [42](#)

## I

ICMP Echo [108](#)  
IGMP [139](#)  
IGMP Snooping [140](#)  
IGMP Stats [38](#)  
IP DNS commands [139](#)  
IP Gateway commands [132](#)  
IP IGMP commands [139](#)  
IP interfaces [113](#)  
IP Passthrough [72](#)  
IP routes [113](#)  
IPMap table [113](#)

## K

Keywords, CLI [118](#)

## L

LAN Ethernet Statistics [41](#)  
LAN Host Discovery Table [113](#)  
LEDs [13](#)  
Link commands [143](#)  
links bar [27](#)  
Log [114](#)  
Logging in [105](#)  
Logs [80](#)

## M

MAC Filtering [47](#)  
Management commands [146](#)  
Memory [114](#)

## N

NAT Pinhole commands [157](#)  
NAT Table [85](#)  
NAT/Gaming [67](#)  
NSLookup [78](#)  
NTP commands [142](#)

## P

Packet Filters [60](#)  
Password  
    Administrator [105](#)  
    User [105](#)  
Physical interfaces commands [150](#)  
Ping [78](#)  
Ping command [108](#)  
PPP [117](#)  
priority queue [219](#)  
Prompt, CLI [106](#), [118](#)

## Q

QoS [217](#)  
Quality of Service [217](#)

## R

Redirect page [23](#), [149](#)  
Reset Connection [83](#)  
Reset Device [83](#)  
Reset IP [83](#)  
Resets [83](#)  
Restart [83](#), [110](#)  
Restart command [106](#)  
Restart Modem [33](#)

## S

Safety Instructions [12](#)  
Security  
    filters [60](#)  
Session Initiation Protocol [160](#)  
SHELL  
    Command Shortcuts [106](#)  
    Commands [106](#)  
    Prompt [106](#)  
SHELL level [118](#)  
SHELL mode [106](#)  
show config [110](#)  
Show ppp [117](#)  
SIP [160](#)  
Step mode [119](#)  
Subnets & DHCP [49](#)  
Supported Games and Software [70](#)  
Syslog [84](#)  
System commands [173](#)  
System Information [29](#)

---

## T

tab bar [27](#)  
Targeted Ad Insertion [171](#)  
Telnet [105](#)  
Telnet command [115](#)  
Test Web Access [78](#)  
TFTP server [108](#)  
Traceroute [78](#)  
Trivial File Transfer Protocol [107](#)  
Troubleshoot [77](#)  
Truncation [118](#)

## U

Update [82](#)  
Upstream QoS [220](#)  
User name [105](#)  
User password [105](#)

## V

View command [119](#)  
view config [115](#)  
Voice [54](#)  
Voice-over-IP [160](#)  
VoIP [160](#)

## W

weighted fair queue [219](#)  
WiFi-Key [45](#)  
Wireless [43](#)  
Wireless Security [45](#)





ARRIS® DSL Gateways

ARRIS Enterprises, Inc.  
600 North U.S. Highway 45  
Libertyville, Illinois 60048 USA  
Telephone: +1 847 523 5000

October 6, 2014



