



# Installation Guide

## Outdoor CPE

CPE210 / CPE220 / CPE510 / CPE520

# Contents

<b>Overview</b>	<b>01</b>
<b>Hardware Connection</b>	<b>04</b>
Site Consideration .....	04
Connection and Installation .....	06
Lightning & ESD Protection .....	07
<b>Software Configuration</b>	<b>09</b>
Logging into the PharOS .....	09
Configuration for Typical Applications .....	11
<b>Antenna Alignment</b>	<b>13</b>
<b>Specifications</b>	<b>14</b>
<b>FAQ</b>	<b>15</b>

# Overview

TP-Link's Pharos series outdoor CPEs are dedicated to outdoor wireless network solutions. This guide is applicable to products including CPE210, CPE220, CPE510 and CPE520.

## • Package Contents



Pharos CPE

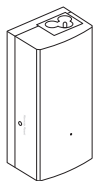

Passive PoE Adapter



Power Cord



Pole Mounting Straps



Installation Guide

## • LED Explanation

The following picture takes CPE520 as an example.

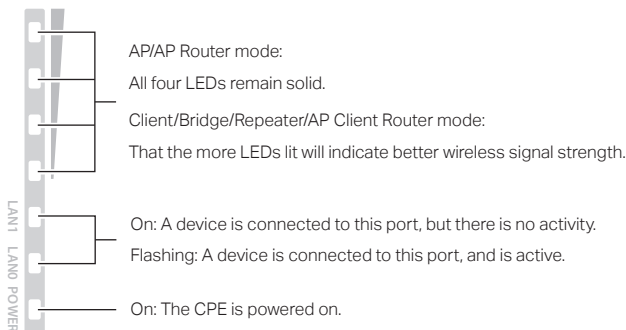

## • Panel Layout

Pharos CPE220/CPE520:

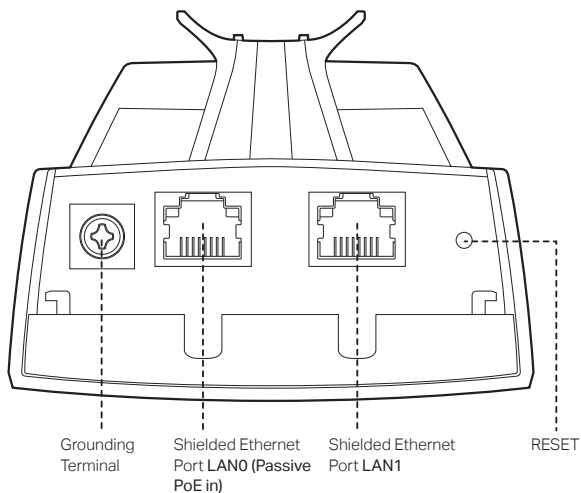

Pharos CPE210/CPE510:

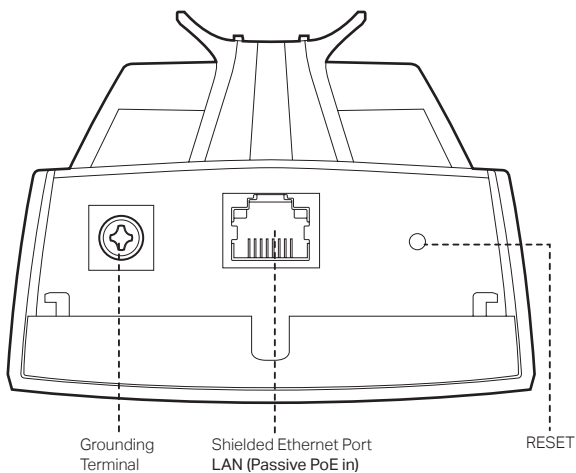

## Passive PoE Adapter:

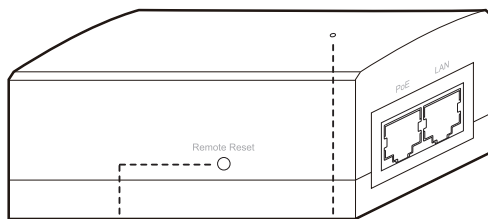

### Remote Reset

Press and hold for 8 seconds to reset the CPE to its factory defaults.

### Power LED

The Power LED is on when the passive PoE adapter is working normally.

# Hardware Connection

## 1. Site Consideration

- **Mounting Height**

Ensure a clear line of sight between the wireless devices for an optimum performance. An elevated location is recommended as obstacles like trees, buildings and large steel structures will weaken the wireless signal.

See 'Q2' in 'FAQ' for details about how to calculate the minimum mounting height of the devices.

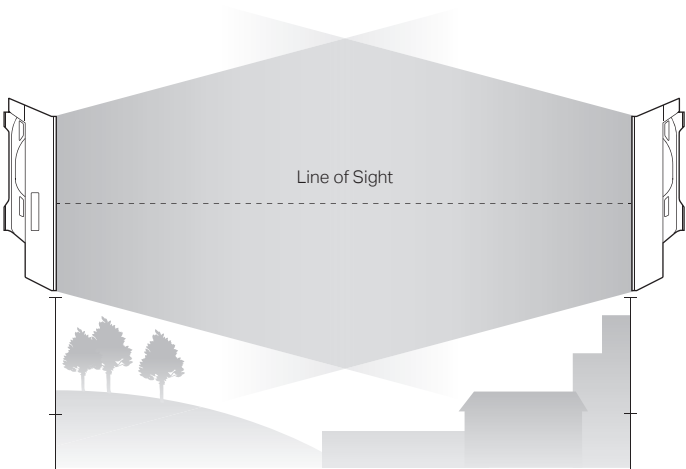

Side View

## • Orientation

Install the CPE devices with the front facing the intended signal receiving devices. You can orient the devices with the assistance of Google Maps, GPS and some landmarks according to the horizontal beamwidth listed below.

Models	CPE210	CPE220	CPE510	CPE520
Horizontal Beamwidth	65°	60°	45°	45°



## 2. Connection and Installation

Please connect and install the device as shown in the figure below. The following introduction takes CPE520 as an example.

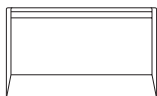
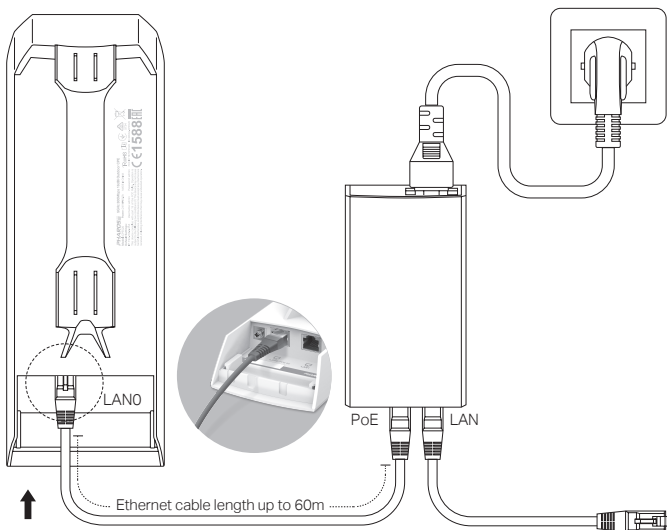

Slide to replace the cover of the CPE when all connections are finished.

You should prepare an adequate Ethernet cable to connect the CPE and the passive PoE adapter. Shielded CAT5e (or above) cable with ground wire is recommended (refer to the next section).

Connect to a computer, router or switch. (Depending on your intended usage and/or network topology.)

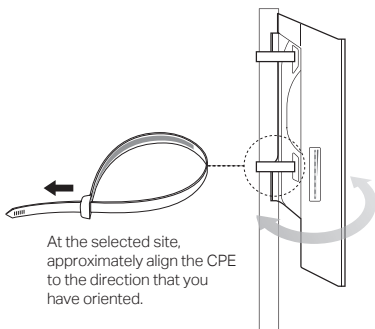



### 3. Lightning & ESD Protection

Proper grounding is extremely important for outdoor devices.

By using shielded CAT5e (or above) cable with ground wire for the connection and the provided PoE adapter (method ①), you can effectively eliminate ESD attacks. If you use the general CAT5e cable for the connection, then it is necessary to connect the grounding terminal of the CPE to earth ground through grounding cable (method ②).

The following introduction takes CPE520 as an example.

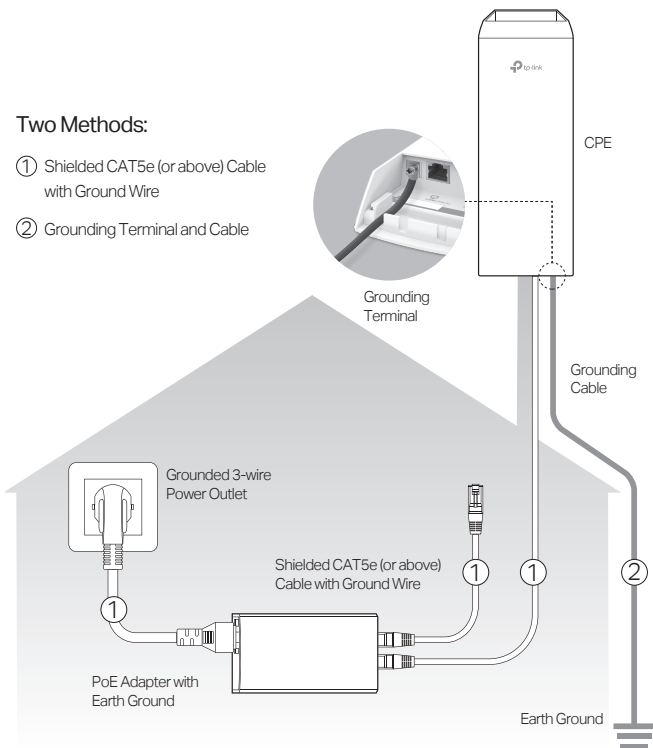

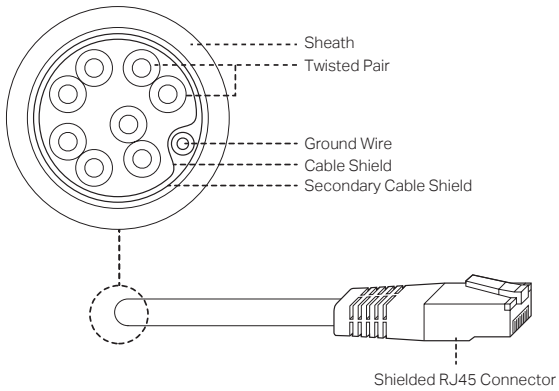

Shielded CAT5e (or above) Cable with Ground Wire

# Software Configuration

This chapter introduces the login to the PharOS Web Interface and the software configurations.

## 1. Logging into the PharOS

1. Before accessing the PharOS Web Interface, you need to assign a static IP address 192.168.0.X (X ranges between 2 and 253, e.g. 192.168.0.10) to your computer.

**General**

You can get IP settings assigned automatically if your network supports this capability. Otherwise, you need to ask your network administrator for the appropriate IP settings.

Obtain an IP address automatically

Use the following IP address:

IP address: 192 . 168 . 0 . 10

Subnet mask: 255 . 255 . 255 . 0

Default gateway: . . .

Obtain DNS server address automatically

Use the following DNS server addresses

Preferred DNS server: . . .

Alternate DNS server: . . .

Validate settings upon exit

Advanced...

OK Cancel

2. Open a web browser, type `http://192.168.0.254` into the address field and press **Enter** (Windows) or **return** (Mac). It is recommended to use the latest version of Google Chrome, Firefox or Safari.

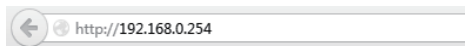

3. Enter **admin** for both **User Name** and **Password**. Read and agree the terms of use, then click **Login**.
4. Change the default User Name and Password to protect your CPE. Let's start configuring the CPE.



For subsequent logins, use the new username and password.

## 2. Configuration for Typical Applications

The typical topology is as follows. A wireless bridge is built between two locations that are far from each other. Follow the instructions below to configure the Access Point and the Client.

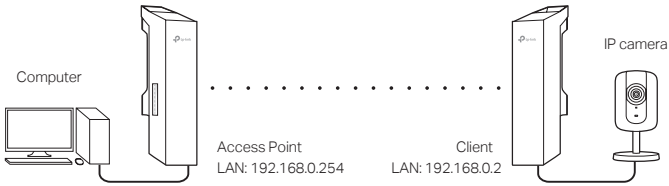

### Configure the Access Point (AP)

1. Log in to PharOS and go to the Quick Setup page.
2. Operation Mode: Select **Access Point** and click **Next**.
3. LAN Settings: Click **Next**.
4. Wireless AP Settings:
  - a. Create a new SSID (Network name) for your wireless network.
  - b. Select **WPA-PSK/WPA2-PSK** for the Security method and create a PSK Password to protect your AP.
  - c. Enter the distance between the Access Point and the Client into the Distance Setting field.
  - d. Select the **MAXstream** checkbox (Refer to Q3 in FAQ for details about MAXstream), and click **Next**.
5. Finish: Verify your settings and click **Finish** to complete the configuration.

### Configure the Client

1. Log in to PharOS and go to the Quick Setup page.
2. Operation Mode: Select **Client** and click **Next**.

3. LAN Settings: Change the IP Address to 192.168.0.X (X ranges between 2 and 253), the same subnet with the access point, and click **Next**.
4. Wireless Client Settings:
  - a. Click **Survey** and select the SSID of the Access Point in the AP list, then click **Connect**.
  - b. Select **WPA-PSK/WPA2-PSK** from the Security option, enter the same PSK password and distance value of the Access Point, then click **Next**.
5. Finish: Verify your settings and click **Finish** to complete the configuration.

# Antenna Alignment

In order to get the best performance, you can precisely align the direction of the CPE with the assistance of Wireless Signal Quality on STATUS page of the PharOS Web Interface.

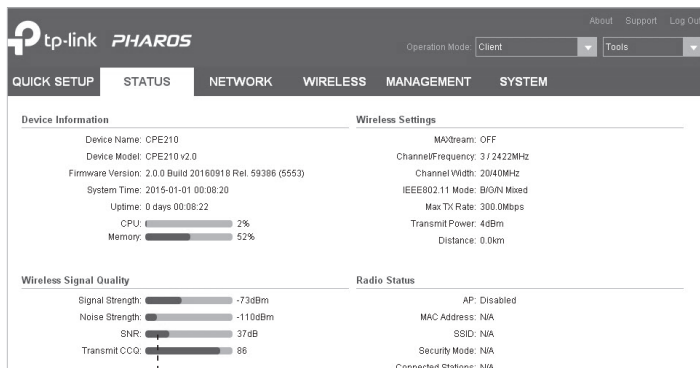

Adjust the direction of the CPE until the device reaches the highest SNR.

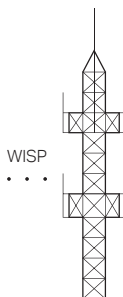
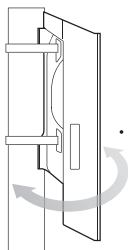
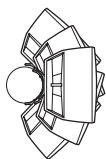

# Specifications

HARDWARE FEATURES				
Dimensions	CPE520/CPE220: 275.83*79*60.3mm CPE510/CPE210: 224.34*79*60.3mm			
Interface	CPE520/CPE220	CPE510/CPE210		
	LAN0: 10/100Mbps Ethernet Port(PoE IN) LAN1: 10/100Mbps Ethernet Port	LAN: 10/100Mbps Ethernet Port(PoE IN)		
	GND: Grounding Terminal for Lightning Protection RESET: Button to restore the device to Factory Default			
Power Supply	24V Passive PoE Adapter Included			
ESD Protection <sup>1</sup>	15kV			
Lightning Protection <sup>1</sup>	Up to 6kV			
Operating Temperature	-30 °C to 70 °C (-22 °F to 158 °F )			
Operating Humidity	10% to 90 %			
Certification	CE, FCC, RoHS, IPX5			
WIRELESS FEATURES				
Models	CPE210	CPE220	CPE510	CPE520
Antenna Gain	9dBi	12dBi	13dBi	16dBi
Horizontal Beamwidth/Elevation Beamwidth <sup>2</sup>	65°/ 35°	60°/ 30°	45°/ 30°	45°/ 30°
802.11 Standards	11b/g/n	11b/g/n	11a/n	11a/n

Note:

1. Estimation is based on copper grounding cable and shielded CAT5e cable with ground wire.
2. Beamwidth values may vary throughout operating frequency.



# FAQ

## Q1. How to restore the CPE to its factory default settings?

With the CPE powered on, press and hold the RESET button on the CPE or the Remote Reset button on the passive PoE adapter for about 8 seconds until the Wireless Signal Strength LEDs flash.

### Method 1:

The following picture takes CPE520 as an example.

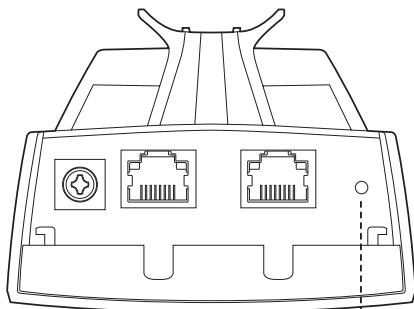

**RESET Button**

Press & hold for about 8 seconds

### Method 2:

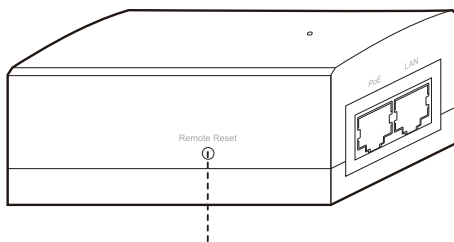

**Remote Reset Button**

Press & hold for about 8 seconds

## Q2. How to calculate the minimum mounting height of the devices?

In order to maximize the received signal strength of the devices, installers need to minimize the effect of the out-of-phase signals, which is caused by obstacles in the path between the transmitter and the receiver. Fresnel Zone is a usual method to calculate this path, as shown in the formula and the figure below.

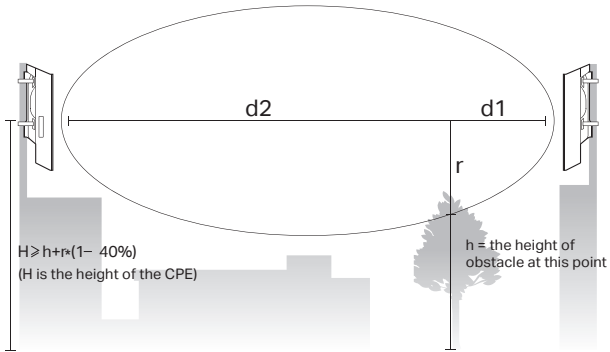

$$r = \sqrt{\frac{d_1 \times d_2}{d_1 + d_2} \cdot \frac{c}{f}}$$

where,

$r$  = Fresnel zone radius in meters

$c = 3 \times 10^8$  m/s, speed of light

$f$  = operating frequency of the devices in Hz

$d_1$  &  $d_2$  = the distances between the point and the devices in meters

For example, assume  $d_1$  is 2km,  $d_2$  is 8km, and  $f$  is 2.4GHz, then  $r$  would be 14.142m. Considering a toleration of 40%, allowable radius would be 8.485m. Assume  $h$  is 10m, then the result of the minimum mounting height based on this point would be 18.485m. Similarly, calculate the results based on all the points where there are obstacles, and the maximum value would be the final result.

For more information, please refer to:

[http://en.wikipedia.org/wiki/Fresnel\\_zone](http://en.wikipedia.org/wiki/Fresnel_zone)

### Q3. What is Pharos MAXstream?

Pharos MAXstream is a proprietary protocol developed on the basis of Time Division Multiple Access (TDMA) by TP-Link.

The MAXstream technology has the following advantages:

- Eliminates hidden node collisions & improves channel efficiency.
- Lower latency, higher throughput, larger network capacity & more stability.
- Improves the QoS for video, voice and sound data stream.

By dividing the timing of transmission into different time slots, MAXstream allows the Pharos devices to transmit in rapid succession, one after another, each using its own time slot to transmit and receive their own frames, which greatly reduces the chance of collision.

Pharos MAXstream is a non-standard Wi-Fi protocol that is only compatible with TP-Link's Pharos series products. Please notice that you will not be able to connect other Wi-Fi devices to an AP with MAXstream enabled.

### Q4. How can I use Spectrum Analysis to find the appropriate channel for the devices?

1. Log in to PharOS, click **Spectrum Analysis** in the tools drop-down list, a window will pop up to remind you that all wireless connections will be lost during spectrum analysis. Click **Yes** to continue to the Spectrum Analysis page.

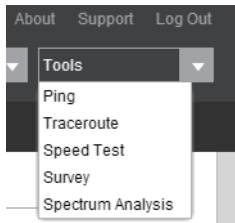

2. Click **Start**, the PharOS will begin to analyze the power of frequency. Observe the curves for a period of time, and then click **Stop**. Note that the relatively low and continuous part of the

average curve indicates less radio noise. Here, we use the figure below as an example.

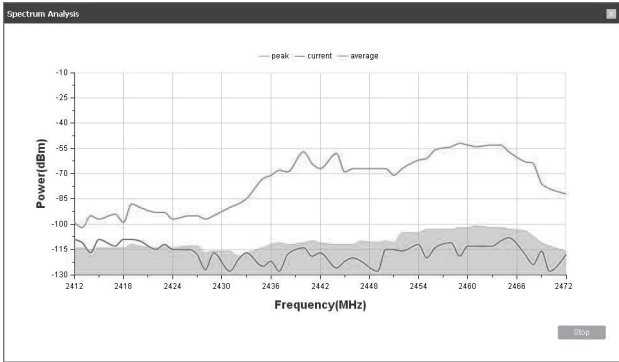

⚠ CPE510 and CPE520 have a select box of Frequency Range at the top-left corner. Select the required range and then click Start.

When choosing channel/frequency, you should avoid the spectrum with large radio noise. In this example, the recommended channel/frequency is 1/2412MHz.

# FCC STATEMENT

This equipment has been tested and found to comply with the limits for a Class A digital device, pursuant to part 15 of the FCC Rules. These limits are designed to provide reasonable protection against harmful interference when the equipment is operated in a commercial environment. This equipment generates, uses, and can radiate radio frequency energy and, if not installed and used in accordance with the instruction manual, may cause harmful interference to radio communications. Operation of this equipment in a residential area is likely to cause harmful interference in which case the user will be required to correct the interference at his own expense.

This device complies with part 15 of the FCC Rules. Operation is subject to the following two conditions:

- 1) This device may not cause harmful interference.
- 2) This device must accept any interference received, including interference that may cause undesired operation.

Any changes or modifications not expressly approved by the party responsible for compliance could void the user's authority to operate the equipment.

Note: The manufacturer is not responsible for any radio or TV interference caused by unauthorized modifications to this equipment. Such modifications could void the user's authority to operate the equipment.

## FCC RF Radiation Exposure Statement:

This equipment complies with FCC RF radiation exposure limits set forth for an uncontrolled environment. This device and its antenna must not be co-located or operating in conjunction with any other antenna or transmitter.

"To comply with FCC RF exposure compliance requirements, this grant is applicable to only Mobile Configurations. The antennas used for this transmitter must be installed to provide a separation distance of at least 22 cm from all persons and must not be co-located or operating in conjunction with any other antenna or transmitter."

## CE Mark Warning

### RF Exposure Information

This device meets the EU requirements (1999/5/EC Article 3.1a) on the limitation of exposure of the general public to electromagnetic fields by way of health protection.

The device complies with RF specifications when the device used at 20 cm from your body.

# CE 1588

This is a Class A product. In a domestic environment, this product may cause radio interference, in which case the user may be required to take adequate measures.

# Canadian Compliance Statement

This device complies with Industry Canada license-exempt RSSs. Operation is subject to the following two conditions:

- 1) This device may not cause interference, and
- 2) This device must accept any interference, including interference that may cause undesired operation of the device.

Le présent appareil est conforme aux CNR d'Industrie Canada applicables aux appareils radio exempts de licence. L'exploitation est autorisée aux deux conditions suivantes :

- 1) l'appareil ne doit pas produire de brouillage;
- 2) l'utilisateur de l'appareil doit accepter tout brouillage radioélectrique subi, même si le brouillage est susceptible d'en compromettre le fonctionnement.

# Industry Canada Statement

CAN ICES-3 (A)/NMB-3(A)



This product can be used in the following countries:

AT / BE / BG / CH / CY / CZ / DE / DK / EE / ES / FI / FR / GB / GR / HR / HU  
/ IE / IS / IT / LI / LT / LV / MT / NL / NO / PL / PT / RO / SE / SI / SK

# Safety Information

- When product has power button, the power button is one of the way to shut off the product; when there is no power button, the only way to completely shut off power is to disconnect the product or the power adapter from the power source.
- Don't disassemble the product, or make repairs yourself. You run the risk of electric shock and voiding the limited warranty. If you need service, please contact us.
- Avoid water and wet locations.



Use only power supplies which are provided by manufacturer and in the original packing of this product. If you have any questions, please don't hesitate to contact us.

# NCC Notice & BSMI Notice

注意！

依據 低功率電波輻射性電機管理辦法

第十二條 經型式認證合格之低功率射頻電機，非經許可，公司、商號或使用者均不得擅自變更頻率、加大功率或變更原設計之特性或功能。

第十四條 低功率射頻電機之使用不得影響飛航安全及干擾合法通信；經發現有干擾現象時，應立即停用，並改善至無干擾時方得繼續使用。前項合法通信，指依電信規定作業之無線電信。低功率射頻電機需忍受合法通信或工業、科學以及醫療用電波輻射性電機設備之干擾。

#### 安全諮詢及注意事項

- 請使用原裝電源供應器或只能按照本產品注明的電源類型使用本產品。
- 清潔本產品之前請先拔掉電源線。請勿使用液體、噴霧清潔劑或濕布進行清潔。
- 注意防潮，請勿將水或其他液體潑灑到本產品上。
- 插槽與開口供通風使用，以確保本產品的操作可靠並防止過熱，請勿堵塞或覆蓋開口。
- 請勿將本產品置放於靠近熱源的地方。除非有正常的通風，否則不可放在密閉位置中。
- 請不要私自打開機殼，不要嘗試自行維修本產品，請由授權的專業人士進行此項工作。

此為甲類資訊技術設備，于居住環境中使用時，可能會造成射頻擾動，在此種情況下，使用者會被要求採取某些適當的對策。



Продукт сертифіковано згідно с правилами системи УкрСЕПРО на відповідність вимогам нормативних документів та вимогам, що передбачені чинними законодавчими актами України.

Website: <http://www.tp-link.com> Tel: +86 755 26504400 E-mail: [support@tp-link.com](mailto:support@tp-link.com)

©2016 TP-Link 7106506831 REV2.0.0