

ASUS™

WL-HDD2.5

(For 802.11g Wireless Clients)

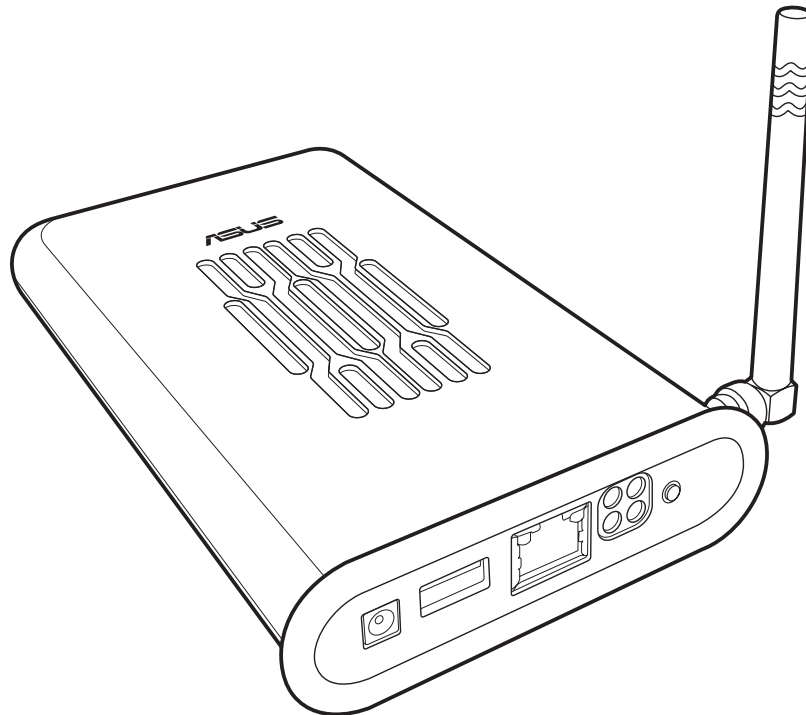

User's Manual

Preface

About this manual

This manual helps you install, set up and configure the ASUS WL-HDD2.5. Please preserve this manual for ready reference and use it to familiarize yourself with the product.

Copyright information

No part of this manual, including the products and software described in it, may be reproduced, transmitted, transcribed, stored in a retrieval system, or translated into any language in any form or by any means, except documentation kept by the purchaser for backup purposes, without the express written permission of ASUSTeK COMPUTER INC. (“ASUS”).

ASUS PROVIDES THIS MANUAL “AS IS” WITHOUT WARRANTY OF ANY KIND, EITHER EXPRESS OR IMPLIED, INCLUDING BUT NOT LIMITED TO THE IMPLIED WARRANTIES OR CONDITIONS OF MERCHANTABILITY OR FITNESS FOR A PARTICULAR PURPOSE. IN NO EVENT SHALL ASUS, ITS DIRECTORS, OFFICERS, EMPLOYEES OR AGENTS BE LIABLE FOR ANY INDIRECT, SPECIAL, INCIDENTAL, OR CONSEQUENTIAL DAMAGES (INCLUDING DAMAGES FOR LOSS OF PROFITS, LOSS OF BUSINESS, LOSS OF USE OR DATA, INTERRUPTION OF BUSINESS AND THE LIKE), EVEN IF ASUS HAS BEEN ADVISED OF THE POSSIBILITY OF SUCH DAMAGES ARISING FROM ANY DEFECT OR ERROR IN THIS MANUAL OR PRODUCT.

Product warranty or service will not be extended if: (1) the product is repaired, modified or altered, unless such repair, modification of alteration is authorized in writing by ASUS; or (2) the serial number of the product is defaced or missing.

Products and corporate names appearing in this manual may or may not be registered trademarks or copyrights of their respective companies, and are used only for identification or explanation and to the owners’ benefit, without intent to infringe.

SPECIFICATIONS AND INFORMATION CONTAINED IN THIS MANUAL ARE FURNISHED FOR INFORMATIONAL USE ONLY, AND ARE SUBJECT TO CHANGE AT ANY TIME WITHOUT NOTICE, AND SHOULD NOT BE CONSTRUED AS A COMMITMENT BY ASUS. ASUS ASSUMES NO RESPONSIBILITY OR LIABILITY FOR ANY ERRORS OR INACCURACIES THAT MAY APPEAR IN THIS MANUAL, INCLUDING THE PRODUCTS AND SOFTWARE DESCRIBED IN IT.

Copyright © 2004 ASUSTeK COMPUTER INC. All Rights Reserved.

Product Name: ASUS WL-HDD2.5

Manual Revision: E1666

Release Date: May 2004

Regulatory information

Federal Communications Commission Statement

This device complies with Part 15 of the FCC Rules. Operation is subject to the following conditions:

- This device may not cause harmful interference; and
- This device must accept any interference received, including interference that may cause undesired operation.

This equipment has been tested and found to comply with the limits for a class B digital device, pursuant to Part 15 of the Federal Communications Commission (FCC) rules. These limits are designed to provide reasonable protection against harmful interference in a residential installation. This equipment generates, uses, and can radiate radio frequency energy and, if not installed and used in accordance with the instructions, may cause harmful interference to radio communications. However, there is no guarantee that interference will not occur in a particular installation. If this equipment does cause harmful interference to radio or television reception, which can be determined by turning the equipment off and on, the user is encouraged to try to correct the interference by one or more of the following measures:

- Reorient or relocate the receiving antenna.
- Increase the separation between the equipment and receiver.
- Connect the equipment into an outlet on a circuit different from that to which the receiver is connected.
- Consult the dealer or an experienced radio/TV technician for help.

WARNING! The use of a shielded-type power cord is required in order to meet FCC emission limits and to prevent interference to the nearby radio and television reception. It is essential that only the supplied power cord be used. Use only shielded cables to connect I/O devices to this equipment. You are cautioned that changes or modifications not expressly approved by the party responsible for compliance could void your authority to operate the equipment.

Reprinted from the Code of Federal Regulations #47, part 15.193, 1993. Washington DC: Office of the Federal Register, National Archives and Records Administration, U.S. Government Printing Office.

Preface

CE conformity statement

The CE symbol indicates compliance of this equipment to the EMC Directive and the Low Voltage Directive of the European Union. These markings indicate that this system meets the following technical standards:

EN 55022 — “Limits and Methods of Measurement of Radio Interference Characteristics of Information Technology Equipment.”

EN 55024 — “Information technology equipment - Immunity characteristics - Limits and methods of measurement.”

EN 61000-3-2 — “Electromagnetic compatibility (EMC) - Part 3: Limits - Section 2: Limits for harmonic current emissions (Equipment input current up to and including 16 A per phase).”

EN 61000-3-3 — “Electromagnetic compatibility (EMC) -Part 3: Limits - Section 3: Limitation of voltage fluctuations and flicker in low-voltage supply systems for equipment with rated current up to and including 16 A.”

EN 60950 — “Safety of Information Technology Equipment.”

NOTE: EN 55022 emissions requirements provide for two classifications:

- Class A is for typical commercial areas.
- Class B is for typical domestic areas.

To determine which classification applies to your computer, examine the CE registration label located on the back panel of the device. If the label indicates a Class A rating, the following warning applies to your device:

RF INTERFERENCE WARNING: This is a Class A product. In a domestic environment this product may cause radio frequency (RF) interference, in which case the user may be required to take adequate measures. This device is classified for use in a typical Class A domestic environment.

Safety information

to be provided by the client

Customer service information

ASUSTeK COMPUTER INC. (Asia-Pacific)

Address: 150 Li-Te Road, Peitou, Taipei, Taiwan 112
General Tel: +886-2-2894-3447
General Fax: +886-2-2894-3449
Web Site: www.asus.com.tw

Technical Support

MB/Others (Tel): +886-2-2890-7121 (English)
Notebook (Tel): +886-2-2890-7122 (English)
Desktop/Server (Tel): +886-2-2890-7123 (English)
Support Fax: +886-2-2890-7698

ASUS COMPUTER INTERNATIONAL (America)

Address: 44370 Nobel Drive, Fremont, CA 94538, USA
General Fax: +1-502-933-8713
General E-mail: tmdl@asus.com
Web Site: usa.asus.com

Technical Support

Support Fax: +1-502-933-8713
General Support: +1-502-995-0883
Notebook Support: +1-510-739-3777 x5110
Support E-mail: tsd@asus.com

ASUS COMPUTER GmbH (Germany and Austria)

Address: Harkortstr. 25, 40880 Ratingen, BRD, Germany
General E-mail: sales@asuscom.de (for marketing requests only)
General Fax: +49-2102-9599-31
Web Site: www.asuscom.de

Technical Support

Components: +49-2102-9599-0
Notebook PC: +49-2102-9599-10
Support Fax: +49-2102-9599-11
Support E-mail: www.asuscom.de/support (for online support)

ASUSTeK COMPUTER (Middle East and North Africa)

Address: P.O. Box 64133, Dubai, U.A.E.
General Tel: +9714-283-1774
General Fax: +9714-283-1775

Table of Contents

Chapter 1 Introduction 1

Overview.....	1
Features.....	2
System Requirements	3
Power Requirements.....	3
Package List.....	3
Hardware Components	4
Ports and Buttons.....	4
Status Indicators	5
Wireless Performance	6
Site Topography	6
Range	6
Site Surveys	7
Roaming Between ASUS APs.....	7
Roaming Guidelines	8

Chapter 2 Getting Started 9

Setting up the ASUS WL-HDD2.5.....	9
Hardware Installation	9
Location Tips.....	12
Making Connections.....	13
AP Mode	13
Network Storage Mode	14
Connecting Power.....	15
Configuring the Wireless Client.....	16
TCP/IP Settings	16
SSID Settings.....	19
Using the HDD	20
Accessing the HDD	20
Searching for the Device.....	20
Locating the Device Manually.....	23

Using Internet Explorer.....	25
Hard Drive Pre-scan Function	28
Formatting the Hard Disk	28
Setting up Permissions.....	30
Editing the User List	31
Editing the Shared Nodes List	32
Applying the permissions	34
Sharing Files	35
Transferring Data from External Flash Memory	41
Auto-copy Function.....	41
Locating the Copied Files on the HDD	42
Shutting down the ASUS WL-HDD2.5.....	43

Chapter 3	Software Configuration	44
------------------	-------------------------------	-----------

Connecting to the Web Interface	44
Wired Ethernet Connection	44
Wireless Connection.....	44
Configuring the ASUS WL-HDD2.5	45
Wireless	45
Interface	46
Bridge.....	50
Access Control	52
Advanced	53
Client Mode	55
IP Config.....	58
LAN	58
DHCP server	59
Storage Setting.....	60
Shared Nodes	61
Disk Tool	63
System Setting	64
Change Password	64
Firmware Upgrade	65
Factory Default	66
Status and Log	66

Status.....	67
Wireless.....	68
DHCP Leases.....	68

Chapter 4	Troubleshooting	69
------------------	------------------------	-----------

Chapter 5	Appendix	70
------------------	-----------------	-----------

Specifications.....	70
---------------------	----

1. Introduction

Overview

Thank you for purchasing the ASUS WL-HDD2.5. This device is a wireless local area network (WLAN) hard disk drive (HDD) with additional Access Point (AP) functionality. It is designed to be fully compliant with the IEEE 802.11g standard and provides data transfer at 54 Mbps using the OFDM (orthogonal frequency division multiplexing) technology. It is also backward compliant with 802.11b standards and can be adapted for wired environments for data storage.

Wireless LANs are complementary extensions to existing wired LANs, offering mobility while maintaining continuous network connectivity to both corporate and home Intranets. They add a new level of convenience for LAN users. PC users stay connected to the network anywhere throughout a building without being bound by LAN cables. This is accomplished through the Access Point functionality of the ASUS WL-HDD2.5. The device also has the additional advantage of providing network storage with its HDD. This allows you to share information and storage capacity through the WLAN and use the hard disk like a public wireless folder. The large storage capacity of the hard disk and a high speed data transfer of 54 Mbps makes the ASUS WL-HDD2.5 a very useful tool to share music and video files. The ASUS WL-HDD2.5 also supports automatic copying of files from a flash memory disk to the hard disk.

Features

The ASUS WL-HDD2.5 has the following useful features:

- 54 Mbps high speed WLAN access
 - Maximum available speed of 54 Mbps over the 2.4 GHz frequency band
 - Compatible with existing 802.11b WLAN environments
 - Auto fallback algorithm to select transmission rate
- Secure wireless connectivity
 - AP mode: 64/128 bit WEP, WPA
 - Client mode: 64/128 bit WEP
- Standard IDE device support
 - Uses Ultra DMA 100 IDE controller
 - Adapted for 2.5-inch slim hard disk drives
- Real time clock support with battery backup to synchronize the network time.
- Auto copy function to copy data from an external flash memory disk through USB
- Hard disk pre-scan to scan hard disk functionality at startup
- Windows-based utility to set up WLAN and HDD data access
- Wireless profile enabling connectivity for home or office environments
- HDD access using Network Neighborhood in Windows or Samba in Linux
- UPnP (Universal Plug and Play) feature (upgradeable)
- Firmware upgrade function using Ethernet or WLAN

System Requirements

To begin using the ASUS WL-HDD2.5, your system must have the following minimum requirements:

- An Ethernet (10BaseT or 10/100BaseT) adapter for wired client
- At least one 802.11g (54Mbps) or one 802.11b (11Mbps) wireless adapter for wireless mobile clients
- TCP/IP and an Internet browser installed

Power Requirements

The ASUS WL-HDD2.5 requires power from an external power supply. Your package ships with a 5V, 3A power adapter. Use only the power adapter provided for safe operation.

Package List

Your package contains the following items:

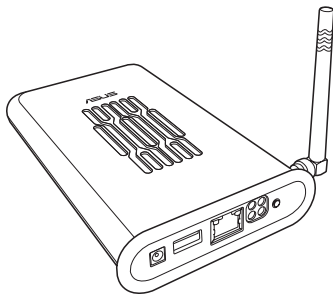

ASUS WL-HDD2.5

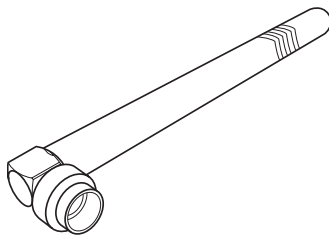

2.4 GHz dipole antenna

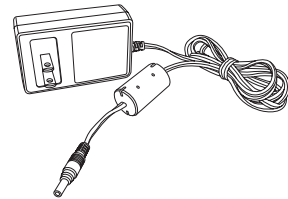

Power adapter (5 Volts DC, 3 Amp)

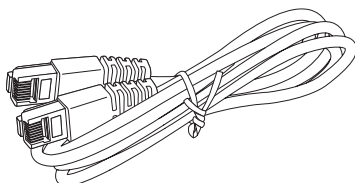

RJ-45 Ethernet cable (straight-through)

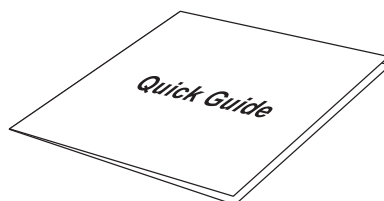

Quick start guide

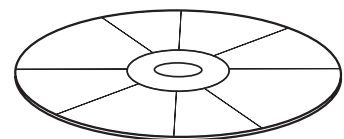

Support CD (utilities and user's manual)

Hardware Components

This section gives you a tour of the different ports and status indicators of the ASUS WL-HDD2.5. Refer to this section when installing and operating your device.

Ports and Buttons

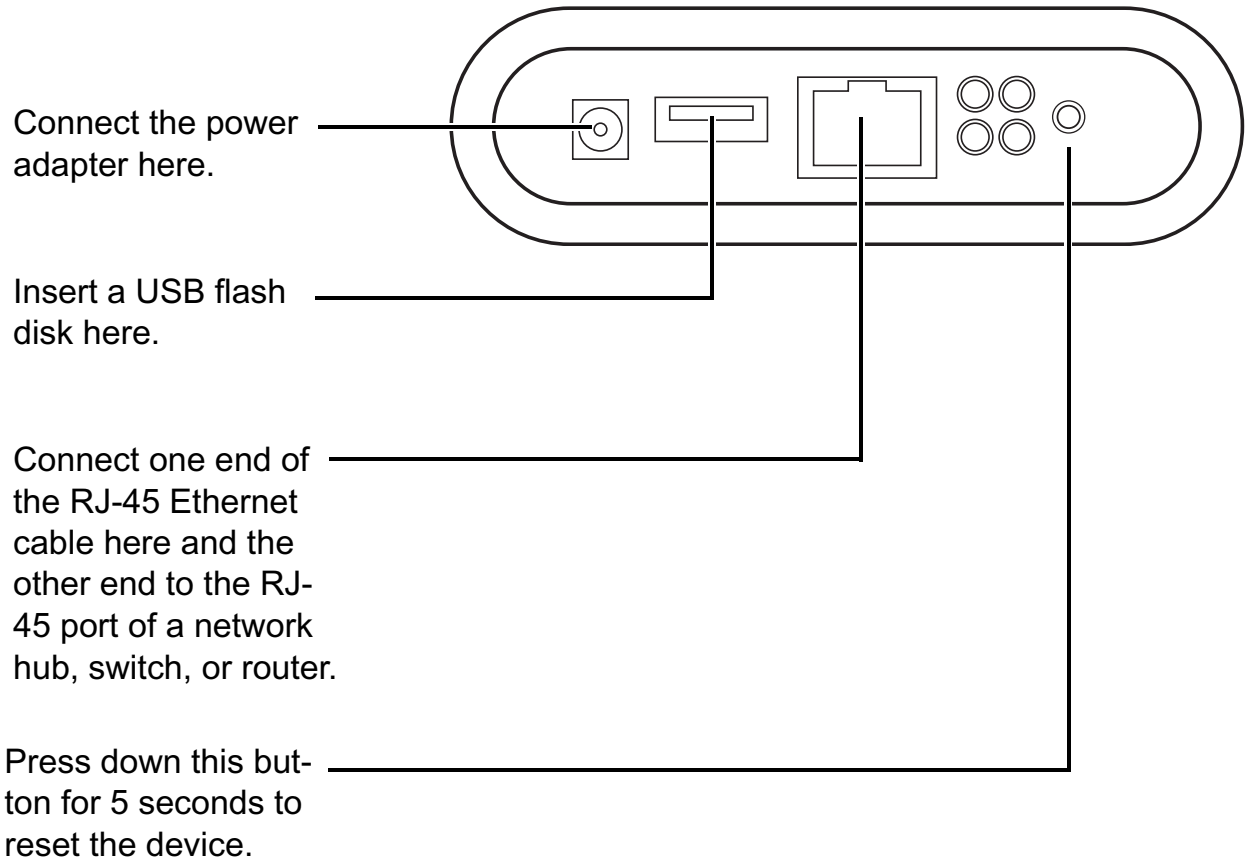

Status Indicators

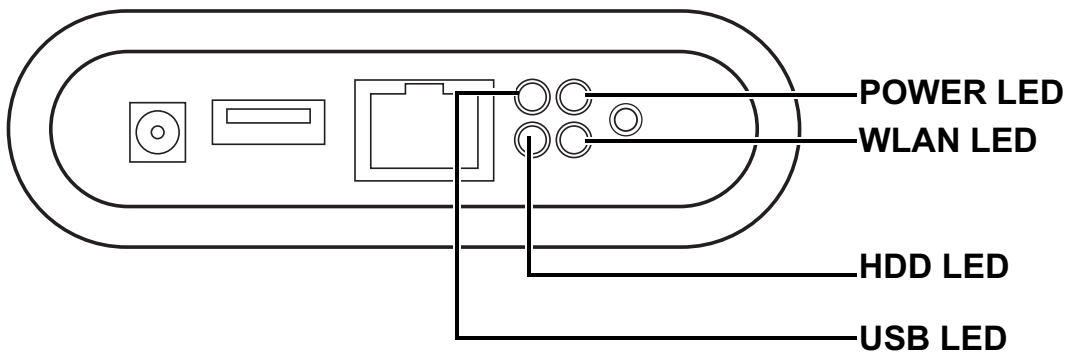

LED	Status	Indication
USB LED	Off	No USB device found
	Blinking (fast)	Copying from the USB device to the HDD
	Blinking (slow)	Partition 1 of the HDD is full
	On	USB device found
HDD LED	Off	Normal state
	Blinking	HDD is being accessed
WLAN LED	On	Normal state
	Blinking	Wireless packets are being transmitted or received
POWER LED	On	Power adapter is plugged in and the device is powered on
	Blinking (slow)	File system on the HDD is inconsistent

Wireless Performance

This section provides a few ideas to help you improve the performance of your WLAN.

Site Topography

For optimal performance, locate wireless mobile clients and the ASUS WL-HDD2.5 away from transformers, heavy-duty motors, fluorescent lights, microwave ovens, refrigerators, and other industrial equipment. Signal loss can occur when metal or concrete walls or floors block transmission. Locate the ASUS WL-HDD2.5 in open areas or add more devices (APs) as needed to improve coverage.

Microwave ovens operate in the same frequency band as the ASUS WL-HDD2.5. Therefore, if you use a microwave oven within range of your device, you may notice network performance degradation. However, your microwave oven and ASUS WL-HDD2.5 will continue to function.

Range

Every environment is unique with different obstacles, barriers, materials, and so on. Therefore, it is difficult to determine the exact range of your WLAN without testing in the specific environment. However, you can follow some of the guidelines described in this section to estimate the range of your network.

Radio signals may be reflected by some obstacles or absorbed by others depending on their construction. For example, with two 802.11b radios, you may achieve clear reception over a distance of up to 1000 feet in open spaces, with the two devices being in line of sight (meaning they have no obstacles in a straight line between them). However, the same two units may only achieve up to 300 feet of range when used indoors.

By default, the ASUS WL-HDD2.5 automatically adjusts the data rate to maintain a usable signal connection. Therefore, a client that is close to the ASUS WL-HDD2.5 may operate at higher speeds while a client that is on the fringe of coverage may operate at lower speeds.

You can configure the data rates used by the ASUS WL-HDD2.5 to improve the performance. However, if you limit the range of data rates available to the ASUS WL-HDD2.5, you may reduce the effective wireless range of the WLAN coverage.

Site Surveys

A site survey (utility provided with ASUS WLAN cards) analyzes the installation environment and provides users with recommendations for equipment and its placement. The optimum placement differs depending on the ASUS AP design and specifications.

Roaming Between ASUS APs

If there are multiple ASUS APs on the network, then a wireless mobile client may seamlessly roam from one ASUS AP to another.

Each ASUS AP creates its own wireless cell or coverage area. This is also known as a Basic Service Set (BSS). Any wireless mobile client can communicate with a particular ASUS AP if it is within the ASUS AP's coverage area.

If the cells of multiple ASUS APs overlap, then the wireless mobile client may switch from one ASUS AP to another as it travels throughout the building. During the hand-off from one ASUS AP to another, the wireless mobile client maintains an uninterrupted connection to the network. This is known as "roaming."

Multiple ASUS APs connected to a common Ethernet network form an Extended Service Set (ESS). All members of an Extended Service Set are configured with an ID, known as the SSID or ESSID. Wireless mobile clients must be configured with the same SSID as the ASUS APs on the network; a client can only roam between ASUS APs that share the same SSID.

Roaming Guidelines

- An ASUS WLAN card can only roam between APs of the same type.
- All ASUS APs must have the same SSID.
- All ASUS WLAN cards must have the same SSID as the APs that they will roam between.
- If WEP encryption is enabled, then all ASUS APs and client adapters must use the same encryption level and WEP Key(s) to communicate.
- ASUS APs' cells must overlap to ensure that there are no gaps in coverage and to ensure that the roaming client will always have a connection available.
- ASUS APs that use the same Channel should be installed as far away from each other as possible to reduce potential interference.
- It is strongly recommended that you perform a site survey using the utility provided with the ASUS WLAN card to determine the best location for each ASUS AP in the building.

2. Getting Started

This chapter provides important information about installing and connecting your ASUS WL-HDD2.5. Read these instructions carefully to set up your device correctly.

Setting up the ASUS WL-HDD2.5

Refer to this section to learn about installing and configuring the ASUS WL-HDD2.5.

Hardware Installation

Follow these steps to insert the hard disk and assemble the device before using it.



Warning: The ASUS WL-HDD2.5 is not hot-swappable. Make sure that it is turned off and not connected to the power outlet when performing the following assembly procedure.

1. Remove the screws from the bottom.

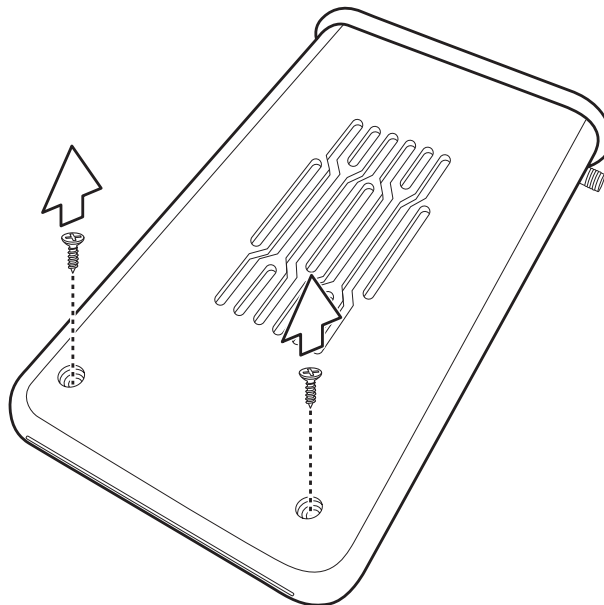

-
2. Remove the front cover and slide out the internal circuit board.

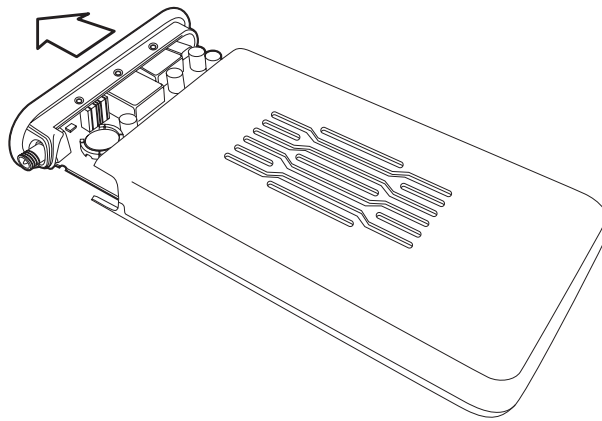

3. Insert the hard drive into the slot. Make sure that the hard drive connecting pins and the connector are properly aligned for a stable connection.

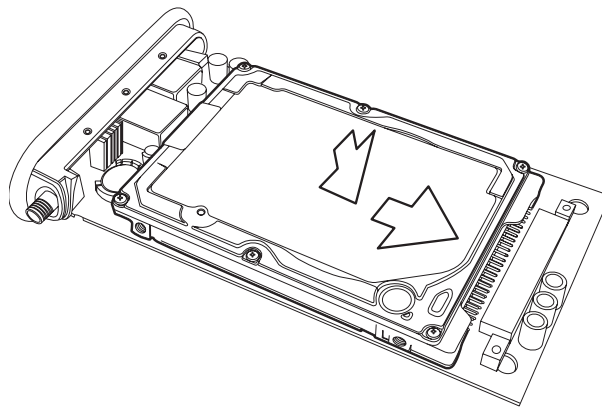

4. Insert the circuit board back inside the outer shell and replace the front cover.

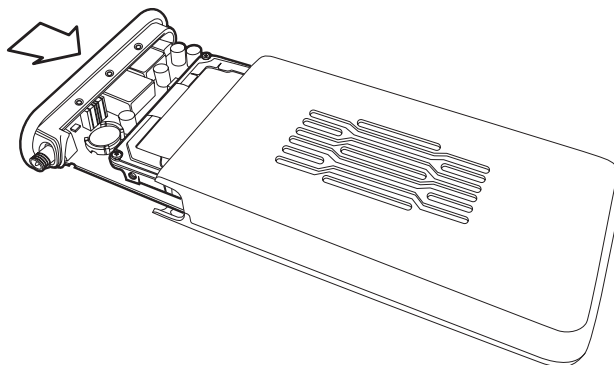

5. Replace the screws.

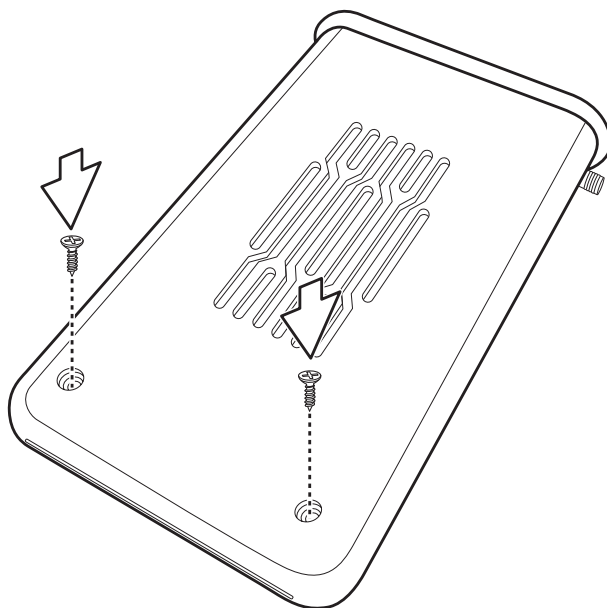

6. Attach the external antenna for improved performance.

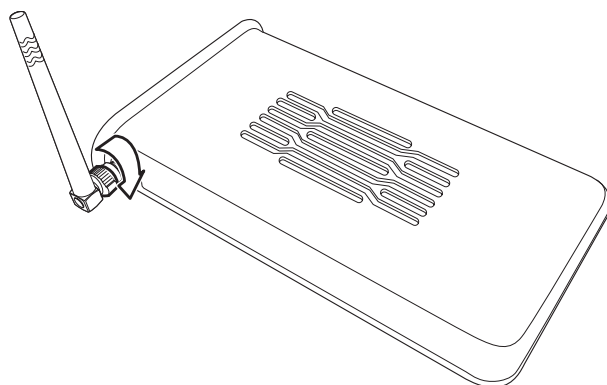

Location Tips

Determine the best location for the device while keeping in mind the following considerations:

- The length of the Ethernet cable that connects the device to the network must not exceed 100 meters.
- For standard placement, try to place the device on a flat, sturdy surface as far from the ground as possible, such as on top of a desk or bookcase, keeping clear of metal obstructions and away from direct sunlight.
- For external antenna mounting, install the external antennas so that they are clear of obstructions; refer to the documentation that came with the antennas for mounting and installation instructions.
- Try to centrally locate the device and its antenna so that it will provide coverage and access to its HDD to all of the wireless mobile devices in the area.
- Use only the power supply that came with this unit. Other power supplies may fit but the voltage and power may not be compatible.



Note: It is the responsibility of the installer and users of the ASUS WL-HDD2.5 to guarantee that the antenna is operated at least 20 centimeters from any person. This is necessary to ensure that the product is operated in accordance with the RF Guidelines for Human Exposure which have been adopted by the Federal Communications Commission.

Making Connections

You can use your ASUS WL-HDD2.5 as an Access Point or as a wireless network storage device in an existing WLAN. When the ASUS WL-HDD2.5 is turned on, it searches for other existing Access Points in its vicinity. If no other AP is found, it acts as an AP, while at the same time allowing access to its HDD. If an existing WLAN and AP is found in the vicinity, it acts as a wireless shared hard disk that can be accessed by other wireless clients in the WLAN.

AP Mode

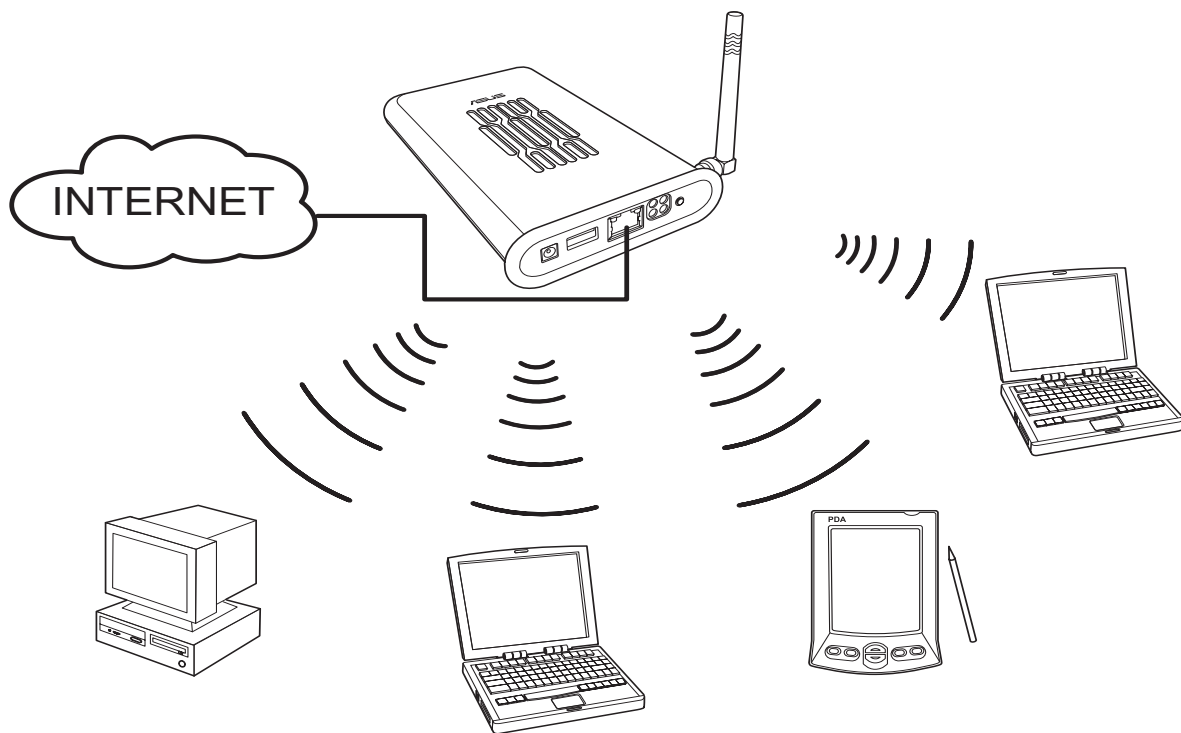

In order to use the ASUS WL-HDD2.5 as an AP, it has to be connected to a network hub for Internet access. Attach one end of the RJ-45 Ethernet cable to the ASUS WL-HDD2.5 and attach the other end to the RJ-45 port of a network hub, switch, router, or patch panel (represented by the INTERNET connection in the illustration).

Network Storage Mode

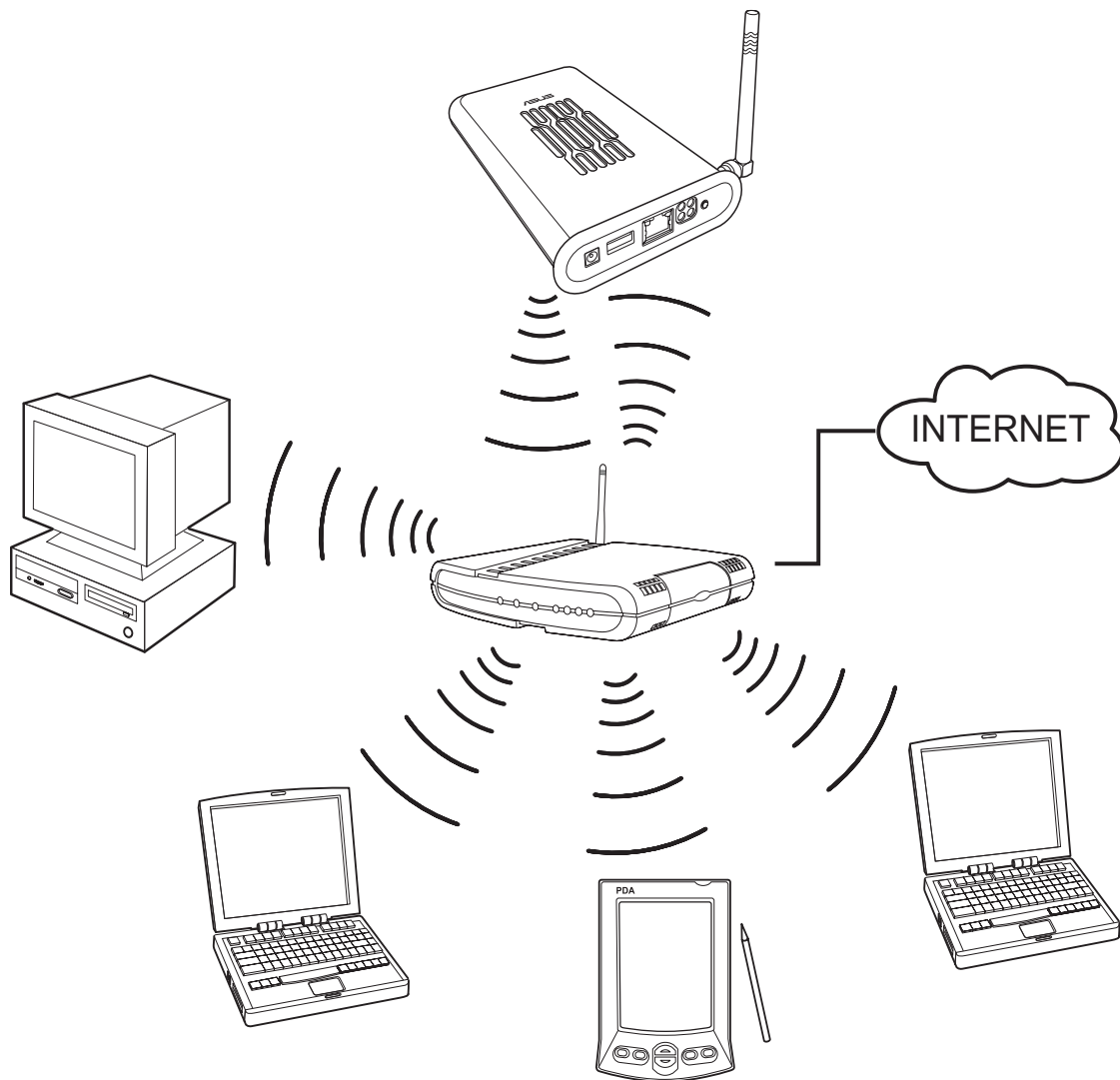

To use the ASUS WL-HDD2.5 as a WLAN storage device in an existing network, no network cable connections to the device are required. The wireless network consisting of an AP and one or more wireless clients, uses the ASUS WL-HDD2.5 as a shared network hard drive. The clients can read or write data from the device as required.

Connecting Power

Attach one end of the AC power adapter, included in the product package, to the power jack on the device and the other end to a power outlet. The POWER LED lights up when the unit is powered ON.

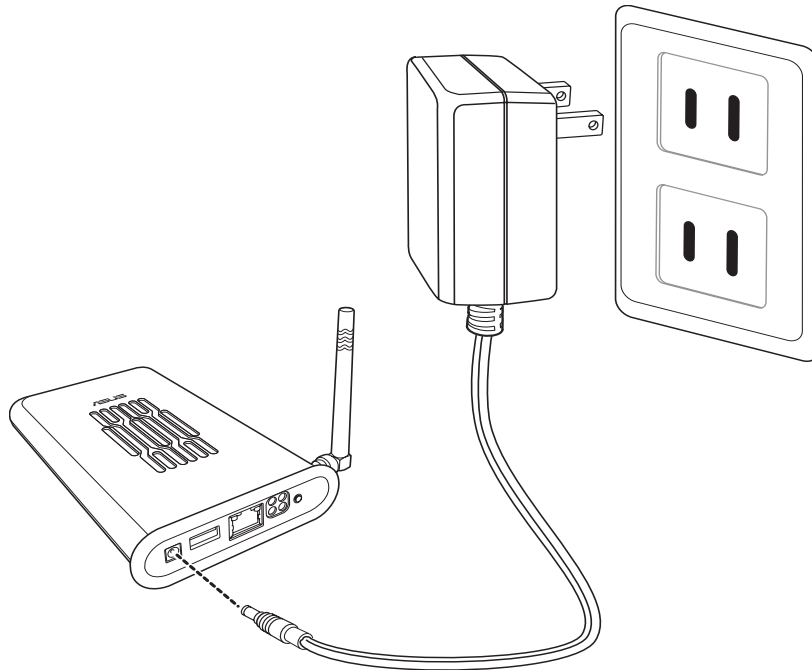

Warnings:

- Use the product only with the power adapter supplied in the product package. Using another power supply may damage the device.
 - To shut down the ASUS WL-HDD2.5, click the **Shutdown** button on the web manager. This prevents damage to the hard disk. Unplug the power cord only after shutting down the device. See “Shutting down the ASUS WL-HDD2.5” on page 43 for details.
-

Configuring the Wireless Client

TCP/IP Settings

In order to access the shared HDD of the ASUS WL-HDD2.5 or to use the device as an AP, you may need to configure the TCP/IP settings. The TCP/IP settings should be on the IP subnet of the ASUS WL-HDD2.5.



Notes:

- Change the TCP/IP settings only if the wireless network does not support automatic IP addresses or if there is a problem operating the device. If you are not sure about the settings, use the default settings where the client obtains the IP address automatically.
- Changing TCP/IP settings may require rebooting your PC (wireless client). When rebooting, the ASUS WL-HDD2.5 should be switched ON and in the ready state.

The following are the default IP settings of the ASUS WL-HDD2.5:

- IP address 192.168.1.1
- Subnet Mask 255.255.255.0.

If you set your computer's (wireless client) IP manually, it needs to be on the same segment as the ASUS WL-HDD2.5. To set the TCP/IP settings, use the **Network and Dialup Connections** wizard to create a new LAN connection and configure its TCP/IP settings as follows:

-
1. Right-click the **My Network Places** icon on the Desktop of your PC and select **Properties**.

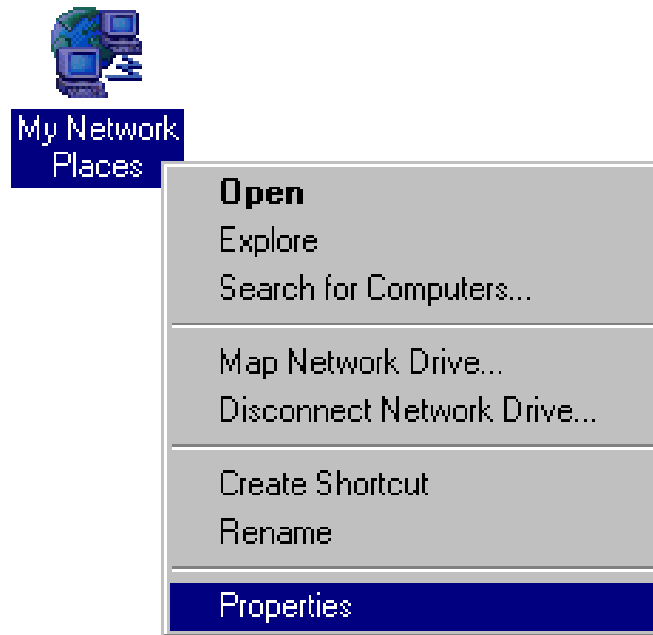

2. In the **Network and Dialup Connections** window displayed, right-click the **Local Area Connection** that you created and select **Properties**.

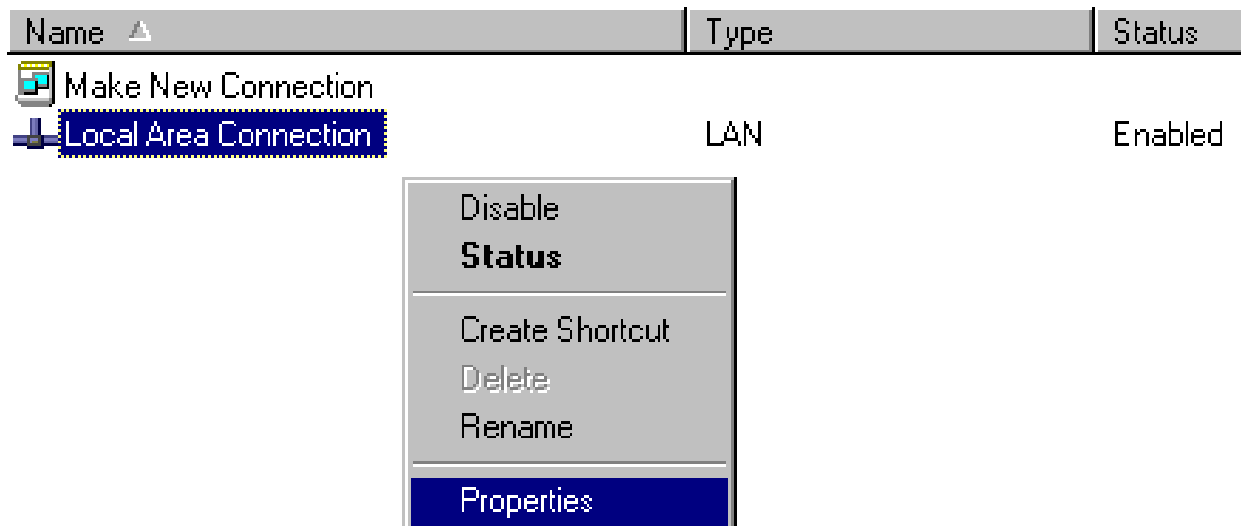

3. On the **General** tab, select **Internet Protocol (TCP/IP)**, and click **Properties**.

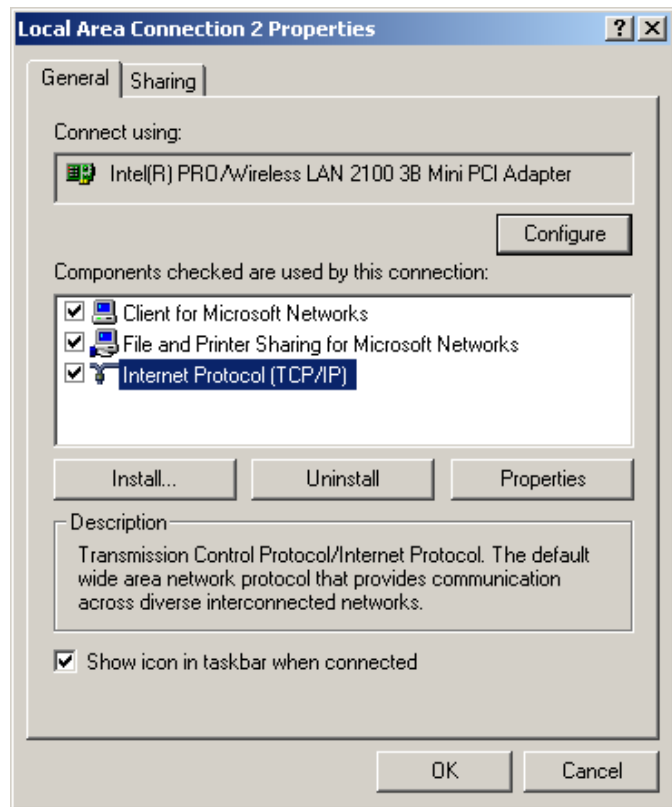

4. To set the TCP/IP address manually, click **Use the following IP address:**, then type the **IP address** and **Subnet mask** as follows:

- IP address
192.168.1.xxx (xxx can be any number between 2 and 254 that is not used by another device)
- Subnet Mask
255.255.255.0 (same as the ASUS WL-HDD2.5)

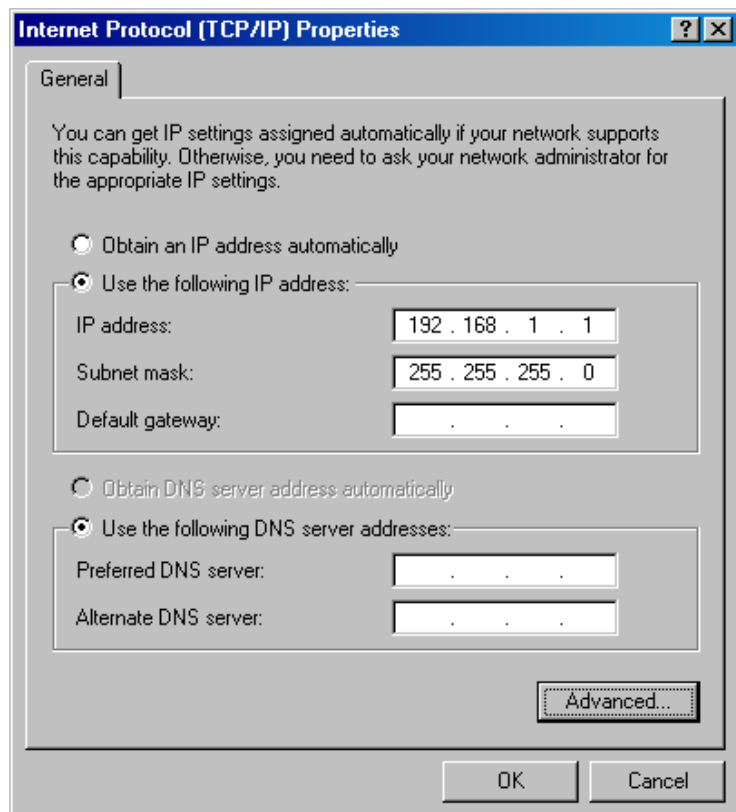

Note: The screens shown here are from a PC running Windows 2000. They may be slightly different for Windows XP.

SSID Settings

The SSID or the network name of the WLAN adapter must be configured correctly for proper operation. Click the **LAN** icon under **Network and Dialup Connections** and right-click to view its **Properties**. Click **Configure** under the **General** tab. Then select the **Wireless Network** tab. Make sure that the **Network Name** is set to **WL-HDD** and click **OK**.

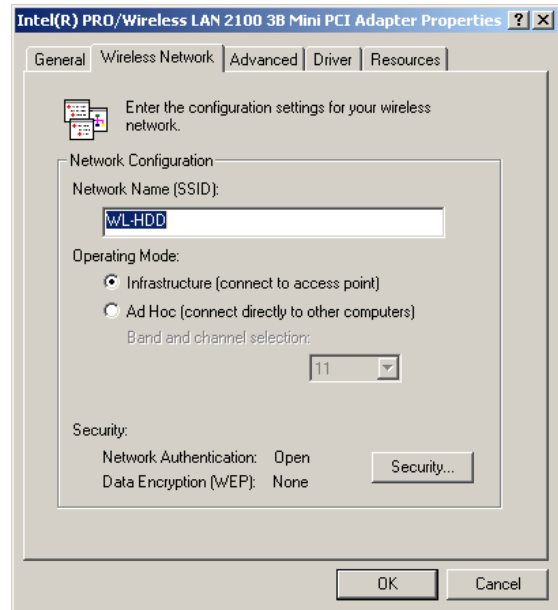

Notes:

- Disable WEP and set the SSID to **default** for any existing wireless LAN device connected to your computer.
 - The procedure described here may be slightly different for various wireless adapter utilities. Refer to the documentation for your wireless client (notebook or PDA) as well as that for the wireless adapter for specific instructions.
-

Using the HDD

Now that you have installed the ASUS WL-HDD2.5 and connected it as required, you are ready to start using the hard drive as a network storage device as described in the following sections.

Accessing the HDD

You can access the hard drive in the following three ways:

Searching for the Device

The easiest method to locate the hard disk from the network is to search for all computers on the network and then locate the hard drive as follows:

1. Open **Windows Explorer**. Then click the **My Network Places** icon.

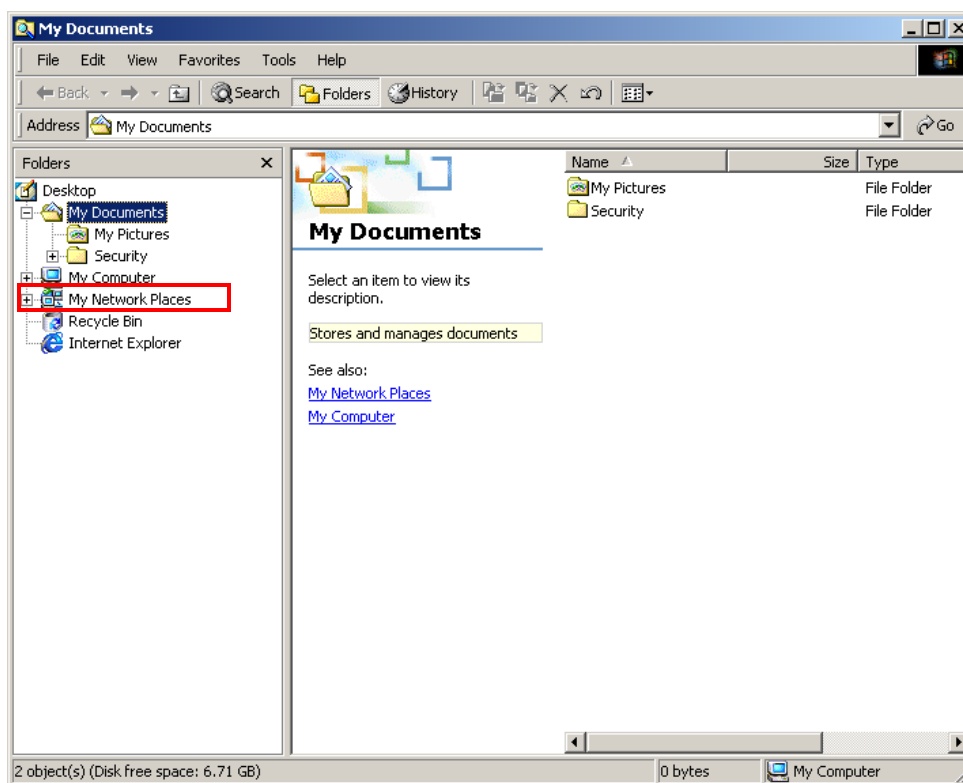

2. Double-click **Entire Network**.

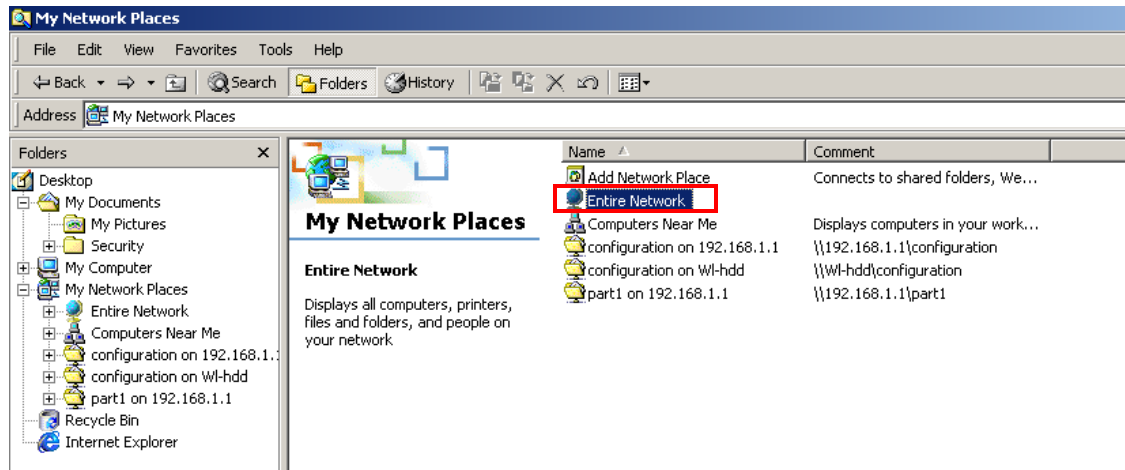

3. Click **Search for computers** to start searching for the ASUS WL-HDD2.5.

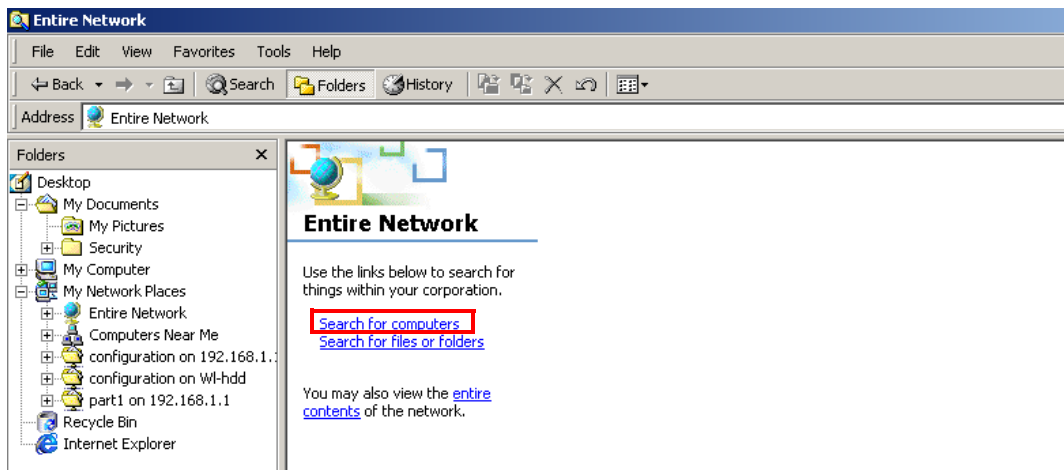

- The search window opens. Type the device name (WL-HDD) in the search field. Then click **Search Now**.

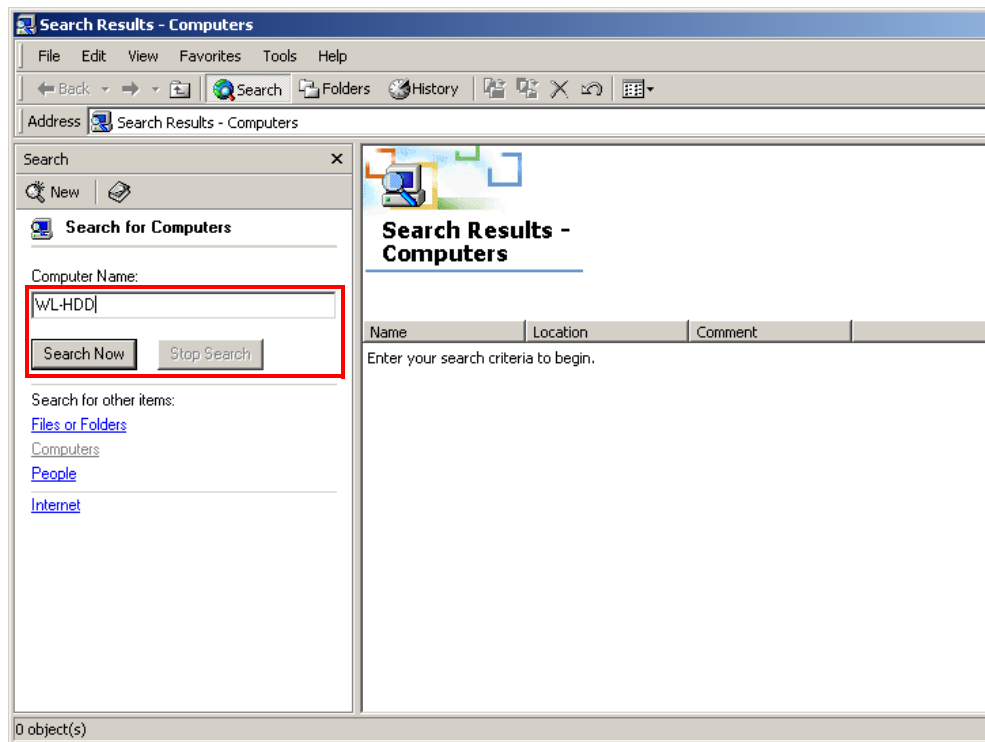

- The search results pane shows the **WL-hdd** icon. Double-click the icon to view the contents of the hard disk.

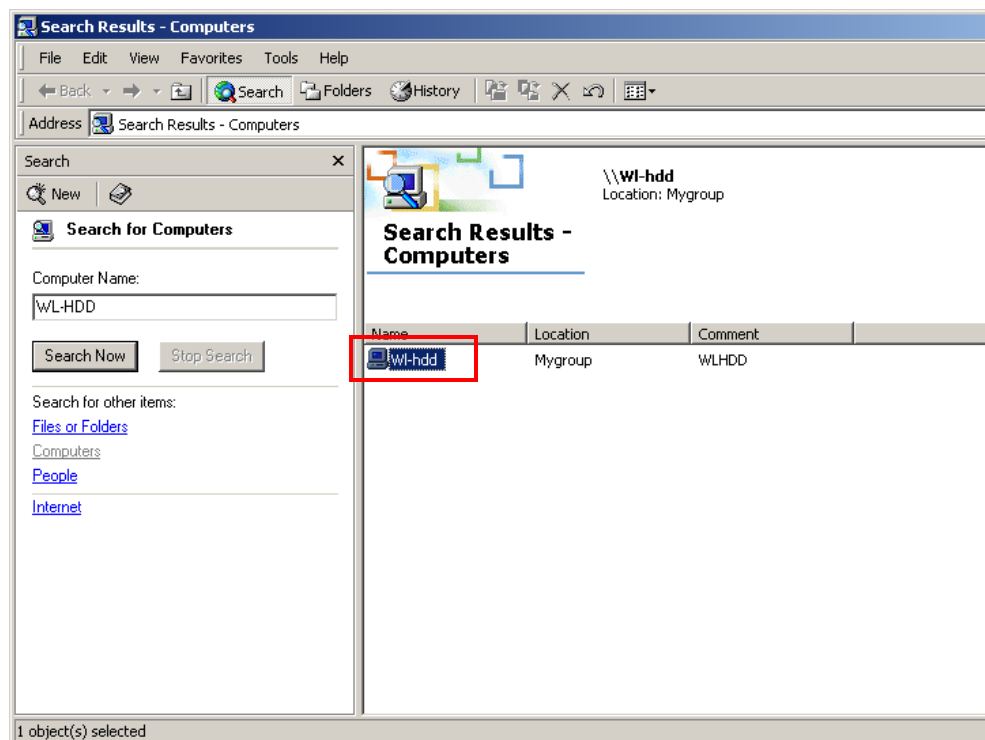

The hard disk shows the configuration folder and the partitions (**part1**, **part2**, etc.) on the HDD. You can set the access permissions for the hard disk drive using the configuration utility described in Chapter 3 (see “Shared Nodes” on page 61).

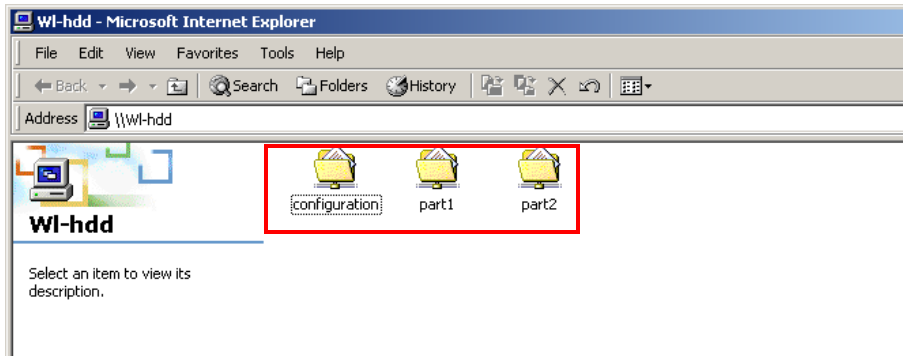

Locating the Device Manually

Follow this procedure to search for the ASUS WL-HDD2.5 manually by browsing the contents of the entire network:

1. Open **Windows Explorer**. Then click the **My Network Places** icon.

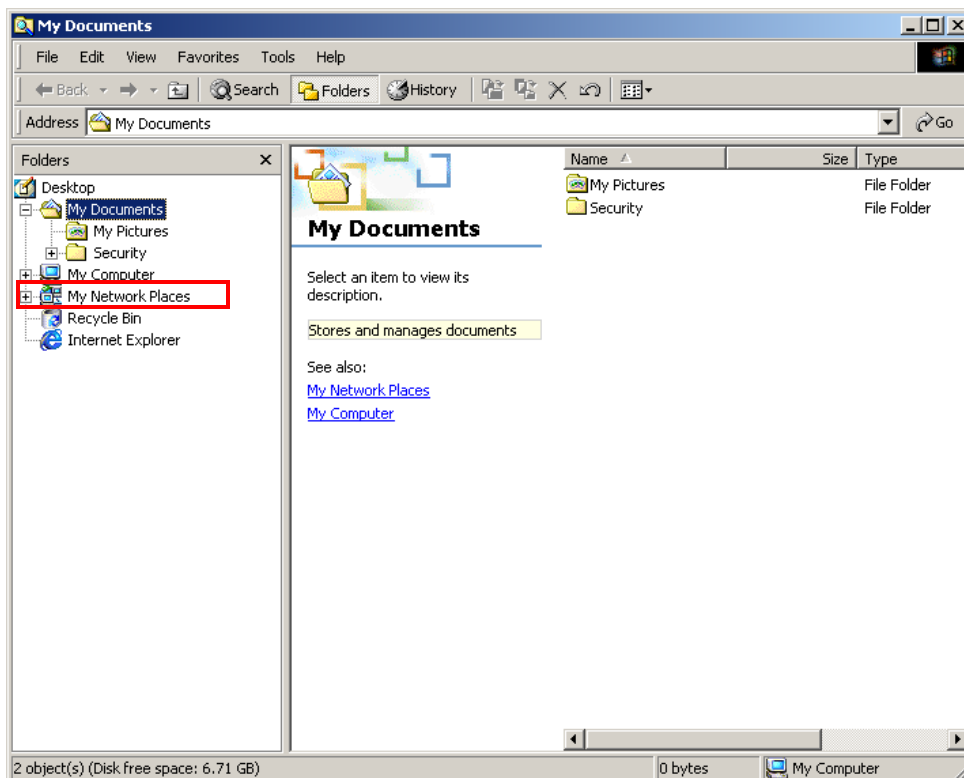

2. Double-click **Entire Network**.

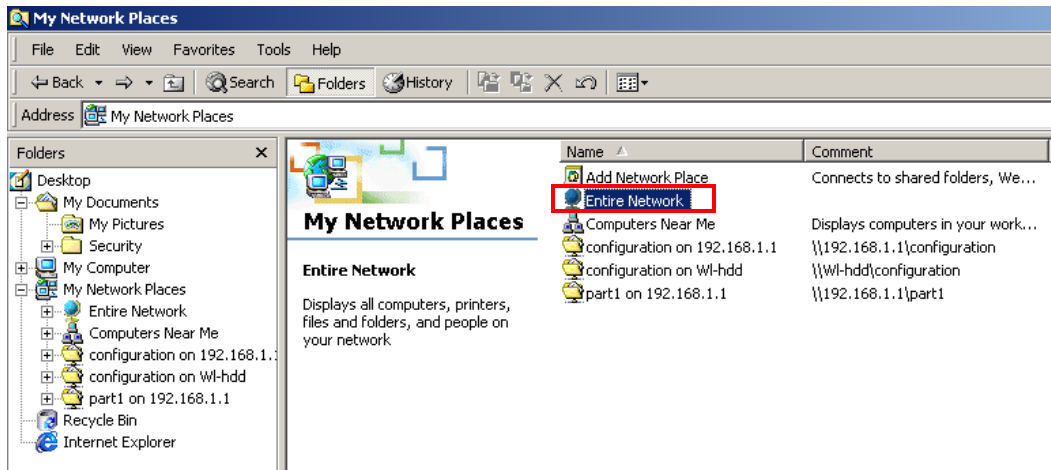

3. Click **entire contents** to view the components of the network.

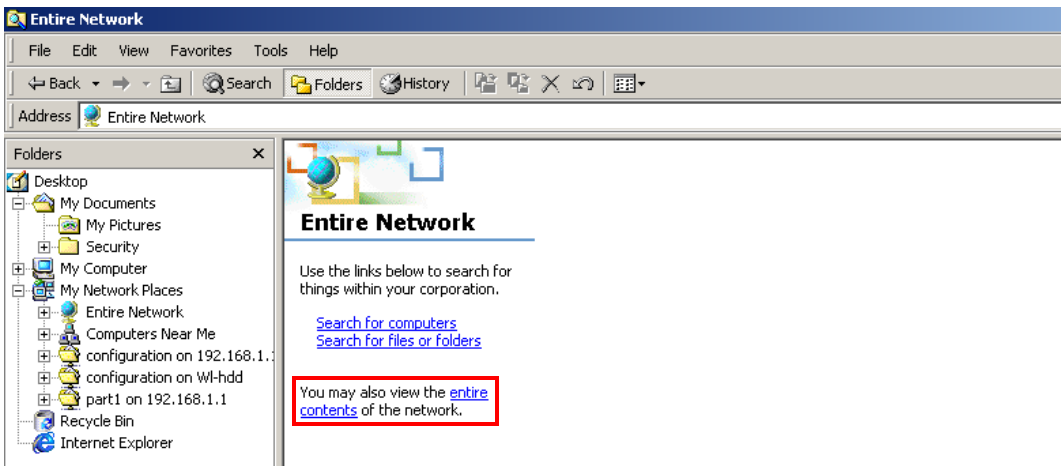

4. Double-click the **Microsoft Windows Network** icon.

5. Search through the various network components displayed in the list until you locate the **Wl-hdd** device. Double-click the **Wl-hdd** icon to view the contents of the hard disk.

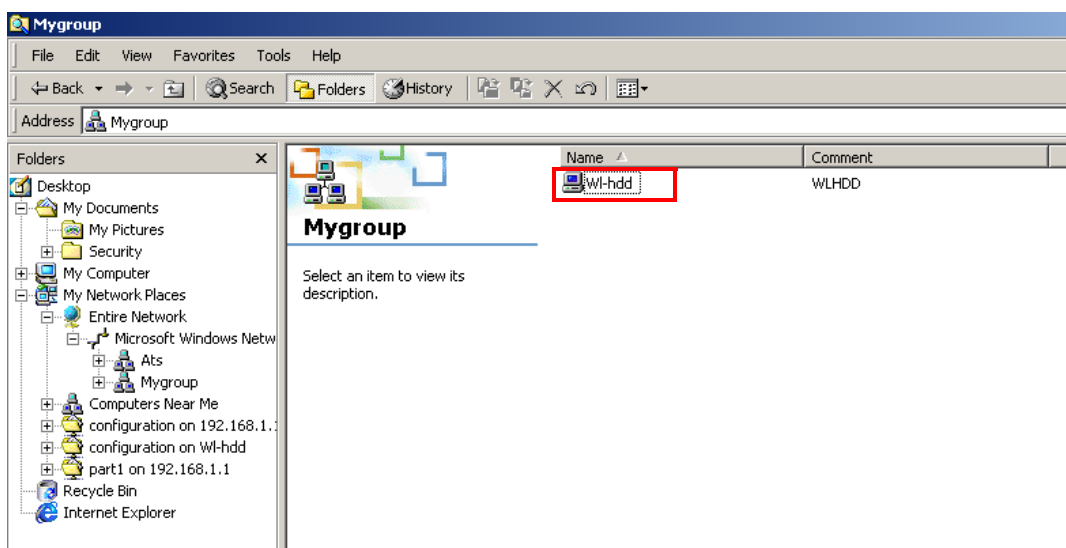

The hard disk shows the configuration folder and the partitions (**part1**, **part2**, etc.) on the HDD. The access permissions for the hard disk drive can be set using the configuration utility described in Chapter 3 (see “Shared Nodes” on page 61).

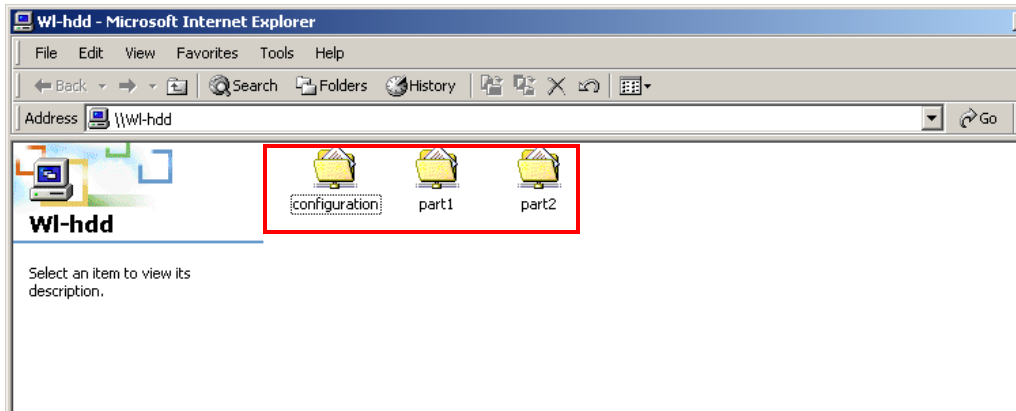

Note: If the WL-HDD folder contents displays only the configuration folder and not the hard disk partitions, this may be because the hard disk drive is not formatted. See “Formatting the Hard Disk” on page 28 to learn how to format the disk.

Using Internet Explorer

To access the HDD of the ASUS WL-HDD2.5 from a wireless client using Internet Explorer, do the following:

1. Open the WLAN adapter utility installed on your wireless client and scan for all available networks within range of your wireless adapter. Refer to the user’s manual accompanying the utility for specific instructions about how to scan for networks.
2. The network list shows the WL-HDD network. Click the WL-HDD icon and press connect if your wireless client is not connected to the device.

-
3. Start **Internet Explorer**. Type in **http://192.168.1.1** in the **Address** box, then click **Go**.

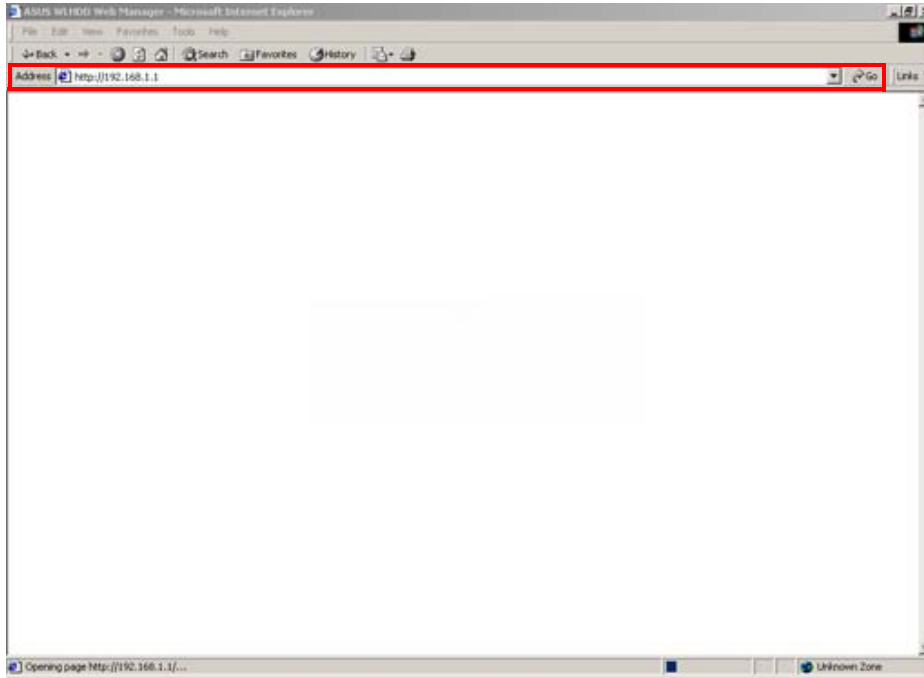

Note: If you have Windows XP running on your wireless client, the ASUS WL-HDD2.5 icon pops up in the notification area on the taskbar when connected.

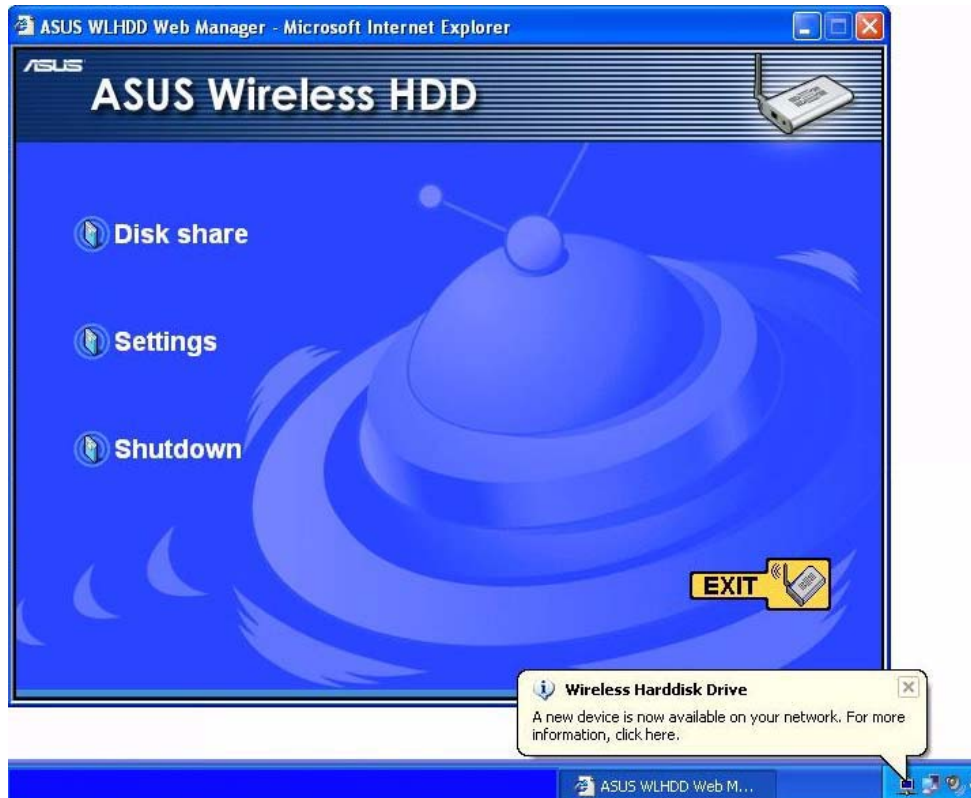

-
4. The ASUS WL-HDD2.5 web manager opens. Click **Disk share** to view the contents of the hard disk.

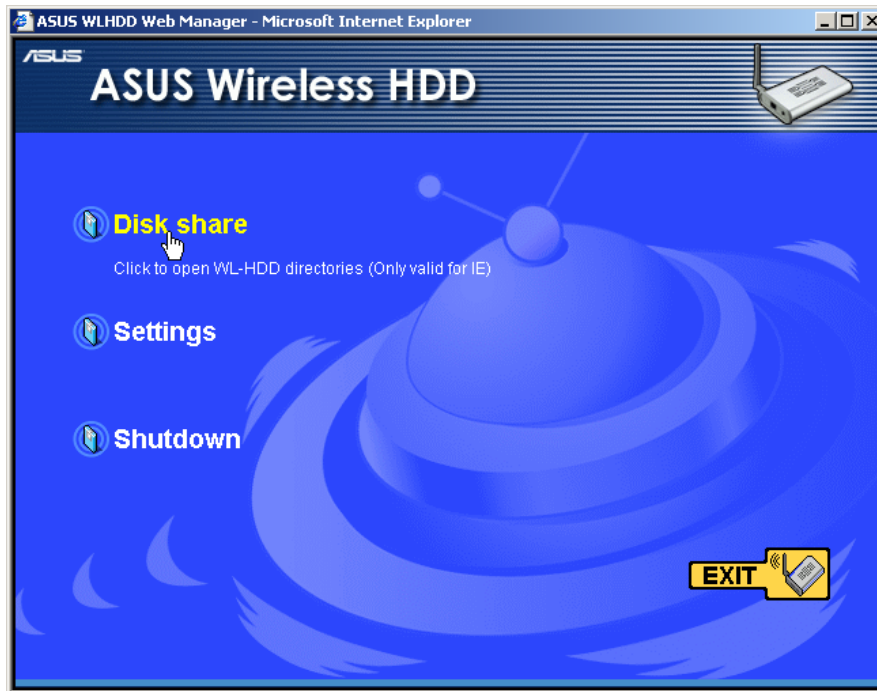

The hard disk shows the **configuration** folder and the partitions (**part1**, **part2**, etc.) on the HDD. The access permissions for the hard disk drive can be set using the configuration utility described in Chapter 3 (see “Shared Nodes” on page 61).

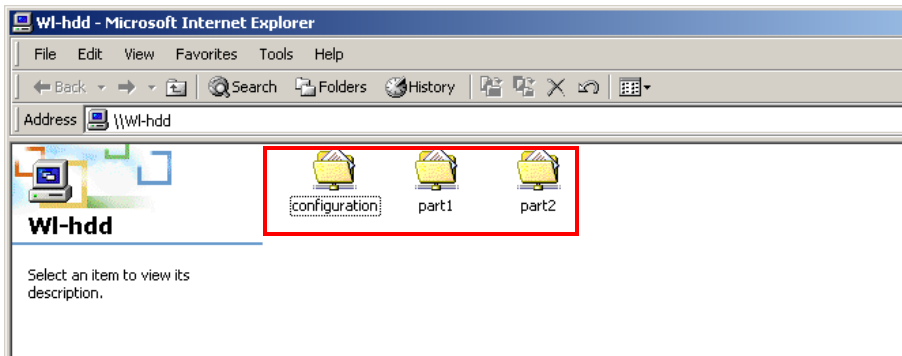

Note: If the WL-HDD folder contents displays only the configuration folder and not the hard disk partitions, this may be because the hard disk drive is not formatted. See “Formatting the Hard Disk” on page 28 to learn how to format the disk.

Hard Drive Pre-scan Function

When the ASUS WL-HDD2.5 is first turned on, it performs a pre-scan of the hard disk drive to ensure that it is functioning correctly and does not have any corrupt data. If the hard drive is not working, has not been formatted, or has been corrupted, a message is displayed on the screen asking you to format the hard disk.



Note: We recommend that you format the hard disk at least once before using it.

Formatting the Hard Disk

To format the hard disk, do the following:

1. The pre-scan function detects the unformatted disk and prompts you to start formatting. Click **OK**.



2. The **Disk Tool** from the **Storage Setting** menu opens in your browser. This tool formats the hard disk and creates up to four (4) partitions. Specify the size of the partitions in megabytes and click **Apply** to start formatting.

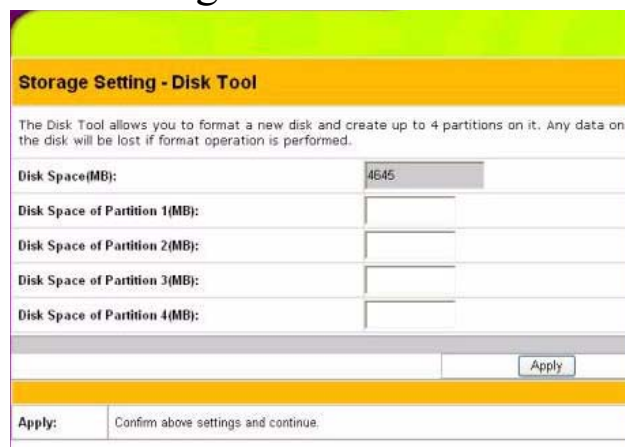

3. A message is displayed on the screen to warn you that formatting will erase all data on the disk. Click **OK** to continue.

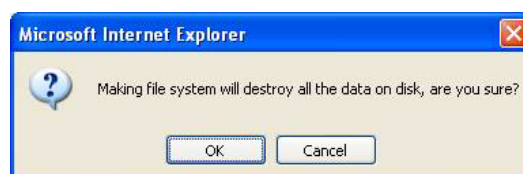

-
4. Formatting of the hard disk begins and the browser window displays the formatting status.

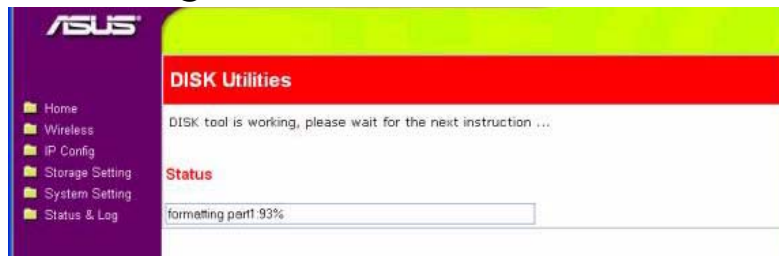

5. After formatting is completed, you are asked to restart the system. Click **Save&Restart** to restart the system.



6. The browser window displays the status while the ASUS WL-HDD2.5 restarts. Wait till the screen is refreshed before using the system.



Note: If you view the disk status using the software configuration tool and if the disk is corrupted (see "Status" on page 67), the following information is displayed.

Status & Log - Status	
System Time:	Tue, 6 Jul 2004 02:00:30 UTC-07:00 <input type="button" value="Sync"/>
Disk	
Model Name:	IC25N020ATMR04-0
Size of Partitions(MegaBytes):	10001;9075;free: 1
Status:	File system inconsistency
Action:	<input type="button" value="File System Check"/>
LAN Interface	
IP Address:	192.168.1.1
Subnet Mask:	255.255.255.0
Default Gateway	
<input type="button" value="Refresh"/>	

Setting up Permissions

You can set up the hard drive permissions so that only the specified users can access it and write data to hard drive. This is a useful feature so as to limit the data that is put on the network storage.

1. Open the ASUS WL-HDD2.5 web manager as described in “Using Internet Explorer” on page 25. Then click **Settings** to configure the settings.

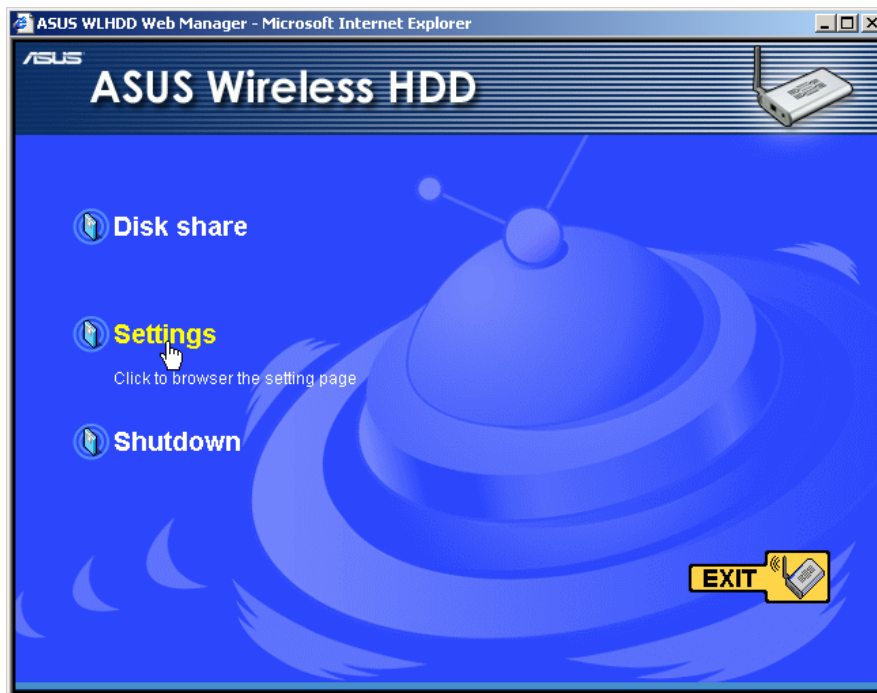

2. Type the default **User name** (admin) and **Password** (admin) in the dialog box.

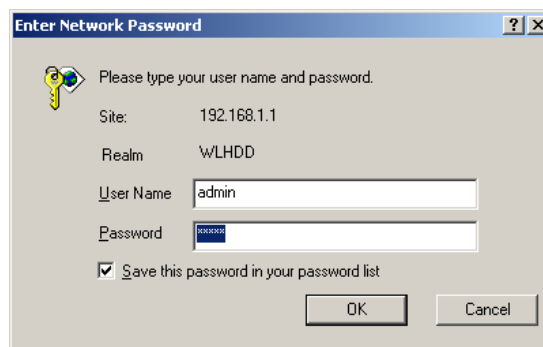

3. The ASUS WL-HDD2.5 configuration web interface is displayed. Click the **Storage Setting** icon in the left pane to display the hard disk settings. Refer to the next two sections to learn how to edit the user and shared file lists.

Editing the User List

The user list is a list of people who are allowed to access to the ASUS WL-HDD2.5. You can add users and their passwords to the list and you can also specify how many users are allowed simultaneous access to the hard drive for optimum performance. To add users to the user list, do the following:

1. Under the **User List** on the **Storage Setting - Shared Nodes** page, type the desired **User Name** and **Password**. Click **Add** to add the user to the list.

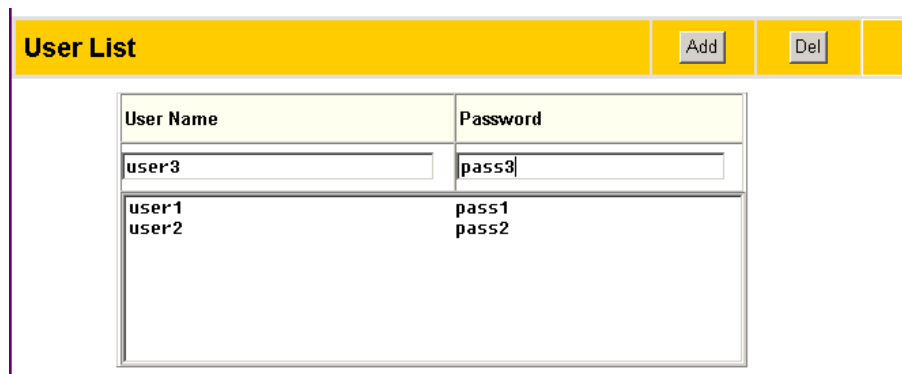

The screenshot shows a web interface titled "User List" with a yellow header bar. To the right of the header are two buttons: "Add" and "Del". Below the header is a table with two columns: "User Name" and "Password". The table contains three rows of data:

User Name	Password
user3	pass3
user1	pass1
user2	pass2

2. Select a **User Name** from the list, then click **Del** to delete the user from the list.
3. Click **Apply** to apply the changes or **Finish** to save the changes and restart the device.

Editing the Shared Nodes List

The shared nodes list is a list of all the folders and partitions on the ASUS WL-HDD2.5 showing the sharing and writing permissions for each node. You can specify which folder or partition is shared and which can be written to. To modify the shared nodes list, do the following:

1. Under the **Shared Nodes List** on the **Storage Setting - Shared Nodes** page, scroll to select the desired folder or partition from the **Folders and Partitions** drop-down box.

Shared Nodes List				
		Add	Del	Edit
Folders and Partitions	part1/USBpart001			
Path	Shared Name	Shared	Write	
part1/USBpart001	USBpart001	<input checked="" type="checkbox"/>	<input checked="" type="checkbox"/>	
part2/	part2	on	on	

2. Type the desired name in the **Shared Name** field. This is the name by which users can access a specific folder or partition using their wireless clients and even map them as logical drives if needed.
3. Click the **Shared** check box to enable the folder or partition to be shared between all users.
4. Click the **Write** check box to enable all users to write data to the folder or partition.
5. Click **Add** to add the folder or partition to the shared nodes list.
6. Select a folder or partition from the list, then click **Del** to delete it from the list.

-
7. Select a folder or partition from the list and click **Edit** to modify permissions for the user in user list.

Storage Setting - Access Right	
Shared Path	part1/music
Shared Name	music
Comment	
Guest	Guest <input checked="" type="checkbox"/> Share <input type="checkbox"/> Write
User Account 1:	user2 <input checked="" type="checkbox"/> Share <input type="checkbox"/> Write
User Account 2:	user1 <input checked="" type="checkbox"/> Share <input type="checkbox"/> Write
User Account 3:	administrator <input checked="" type="checkbox"/> Share <input checked="" type="checkbox"/> Write
User Account 4:	None <input type="checkbox"/> Share <input type="checkbox"/> Write
User Account 5:	None <input type="checkbox"/> Share <input type="checkbox"/> Write
User Account 6:	None <input type="checkbox"/> Share <input type="checkbox"/> Write
<input type="button" value="Apply"/>	
Apply:	Confirm above settings and continue.

- The **Access Right** screen is displayed. Type in the **Shared Name** and any **Comments** if required. Set the user permissions for the **Guest** account and up to six user accounts. Select the appropriate user account names from the drop-down box and check the **Share** and **Write** check boxes to enable sharing and writing to the folder. Click **Apply** to apply the changes to the access rights to the folder.
8. Click **Apply** to apply the changes or **Finish** to save the changes and restart the device.

Applying the permissions

After adding users who can access the hard drive and setting up access rights for the hard drive's partitions and folders, use the **Network Neighborhood Mode** option to apply the permissions. Scroll to select **Apply rules in shared node list** from the field and click **Finish** to save the changes and restart the system.

Storage Setting - Shared Nodes

Network Neighborhood Mode:	<div style="border: 1px solid gray; padding: 2px;"> Apply rules in shared node list ▼ Disable Share all partitions in disk Apply rules in shared node list Login to first partition ▼ </div>
Work Group:	<input type="text"/>
FTP Mode:	<input type="text"/>
Maximum Login User:	<input type="text" value="6"/>

Shared Nodes List

Folders and Partitions	<input type="text" value="part1/"/>		
Path	Shared Name	Shared	Write
<input type="text"/>	<input type="text"/>	<input type="checkbox"/>	<input type="checkbox"/>
part2/ part1/USBpart001 part1/music part1/movies	part2 USBpart001 music movies	on on on on	on

User List

User Name	Password
<input type="text"/>	<input type="text"/>
user2 user1 administrator	pass2 pass1 add

Restore:	Clear the above settings and restore the settings in effect.
Finish:	Confirm all settings and restart WLHDD now.
Apply:	Confirm above settings and continue.

Sharing Files

The ASUS WL-HDD2.5 is primarily designed to help you share data, music, video, or other files over the wireless LAN. You can set up this device in your house, office, or dormitory, such that anyone can access media files from it using a wireless connection.

To share files from the ASUS WL-HDD2.5 that has been set up as your network storage drive, do the following:

1. Connect to the wireless network through your wireless client and access the ASUS WL-HDD2.5 as described in “Accessing the HDD” on page 20.
2. Type a valid user name and password to access data.
3. In order to share data from the ASUS WL-HDD2.5, you must access the HDD using a valid user name. See “Editing the User List” on page 31 for more details about creating users. Only the folders and partitions that have been shared will be visible to you. For instance, in this example, only the second partition (**part2**) and the **movies**, **music**, and **USBpart001** folders have been shared. When you login as a user, only these items will be displayed on the hard drive. However, if you log in as admin, you can see all the contents of the hard drive including the other partitions.

Logging in as ‘user’

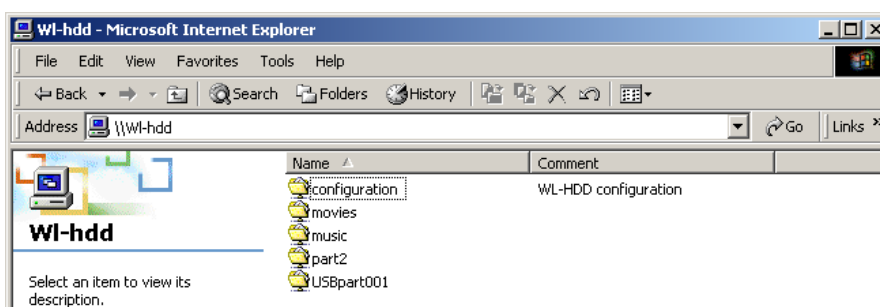

Logging in as ‘admin’

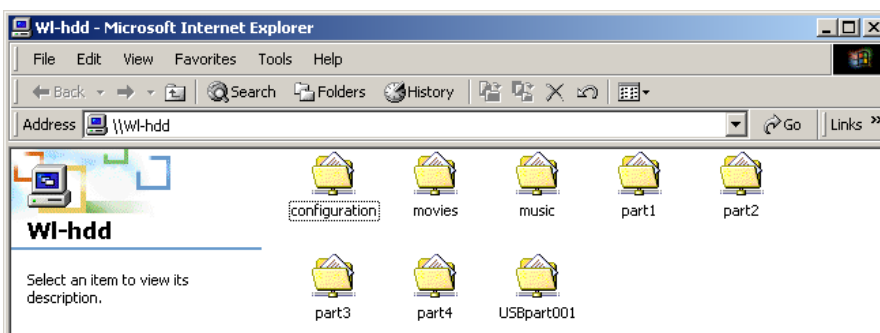

-
4. If you want to copy any data to the hard drive, the destination folder or partition must be write-enabled. Make sure that the access rights (see “Editing the Shared Nodes List” on page 32) are set to **Share – on** and **Write – on** and then copy data to the drive. If the write permissions are not set and you try to copy data to a folder, the following error message will be displayed.

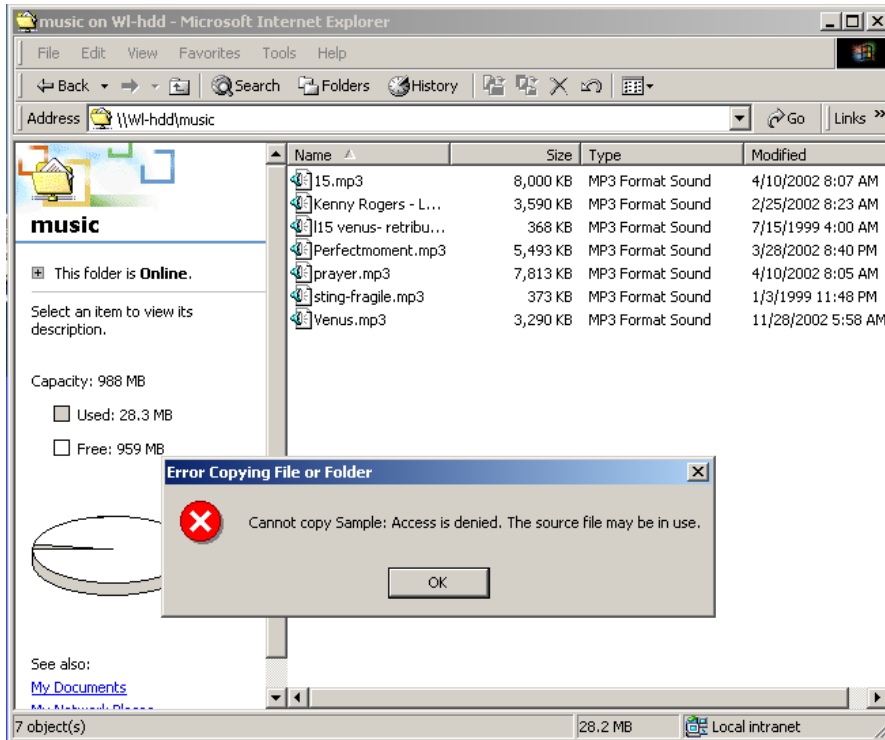

To download files from the ASUS WL-HDD2.5:

Locate the files that you wish to download and then copy them to your local drive as needed. Note that you can only access folders that have been shared by the administrator; see “Editing the Shared Nodes List” on page 32. You can also search for the desired folders using the **Shared Name** as the search criteria. For instance, to search for music files stored on the **music** folder on the first partition (**part1**) on the ASUS WL-HDD2.5, do the following:

1. Locate the **music** folder on the hard disk drive.

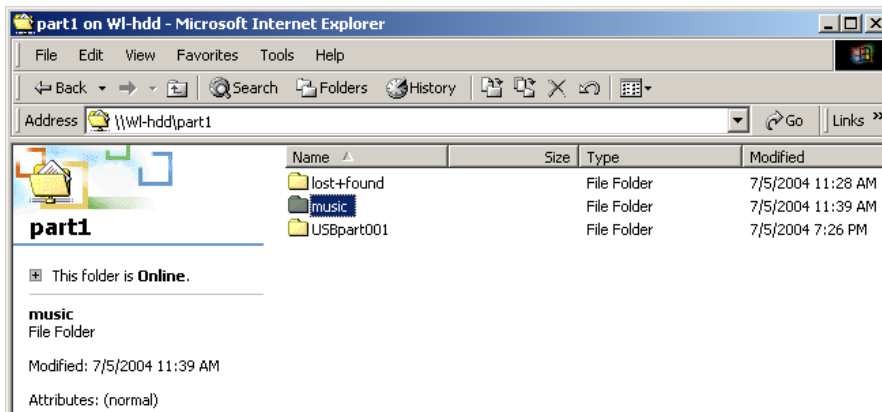

2. Double-click the folder icon to view its contents.

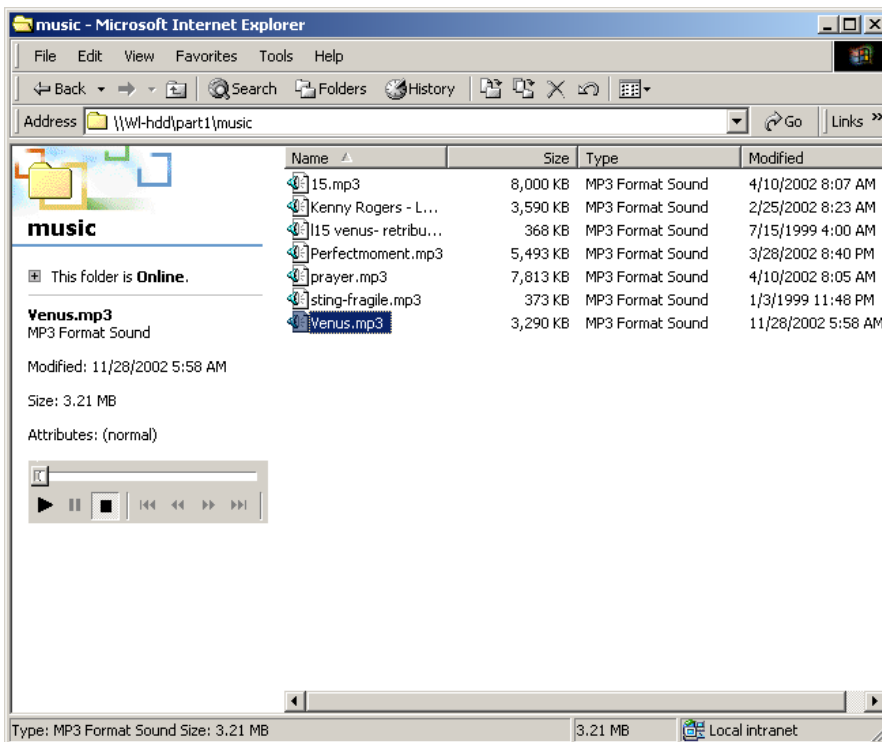

3. Right-click the file(s) that you want to download to your local drive, to view the context menu. Select **Copy** from the context menu.

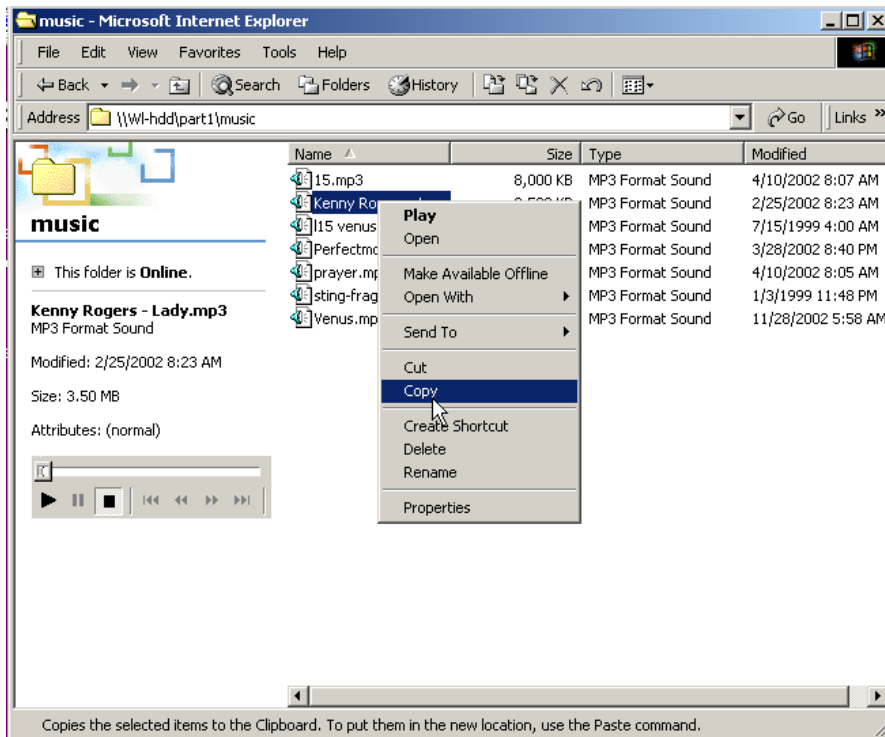

4. Using Windows Explorer, navigate to the location on your local drive where you want to download the selected file. Right-click to view the context menu and select **Paste** to download the music file.

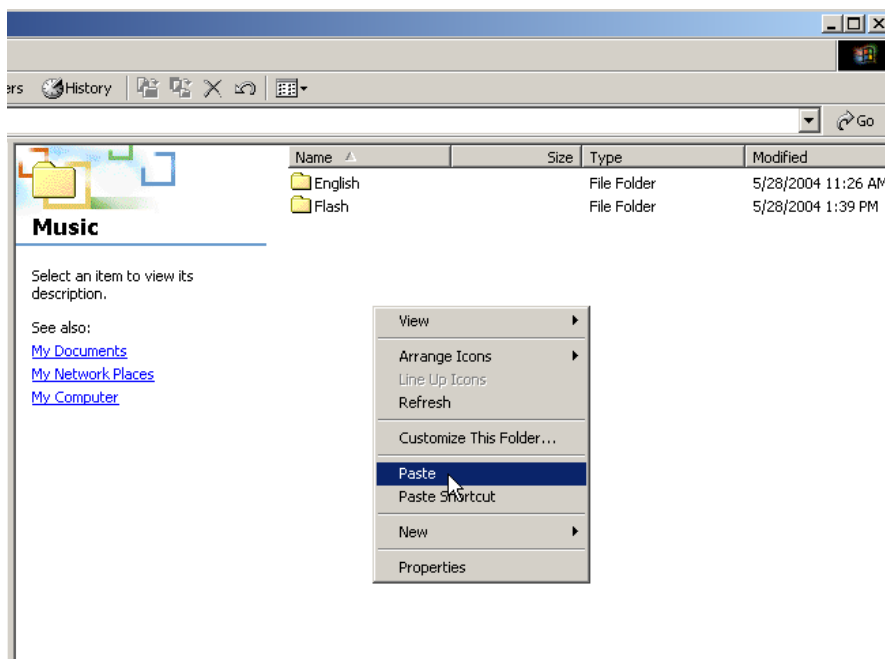

To directly play media files from the ASUS WL-HDD2.5:

You can also play back a music, video or other media file directly from the ASUS WL-HDD2.5 without downloading it to your local drive. The client treats the media file as a shared network file and opens it using the appropriate application. For instance, to play back a music file from the **music** folder on the first partition (**part1**), do the following:

1. Locate the **music** folder on the hard disk drive.

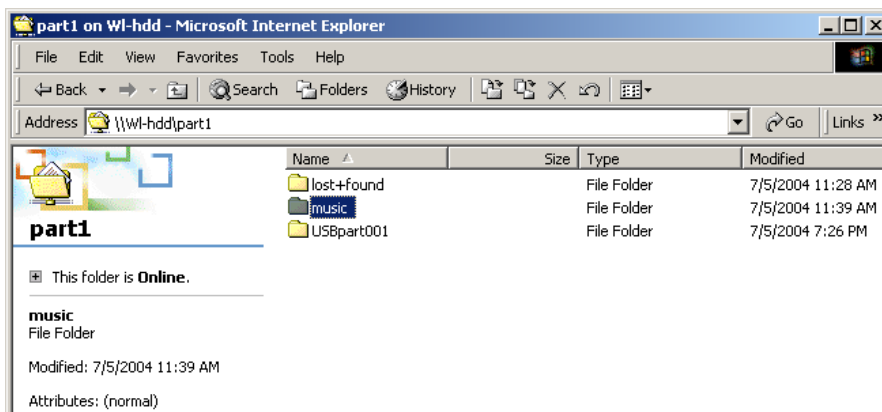

2. Double-click the folder icon to view its contents.

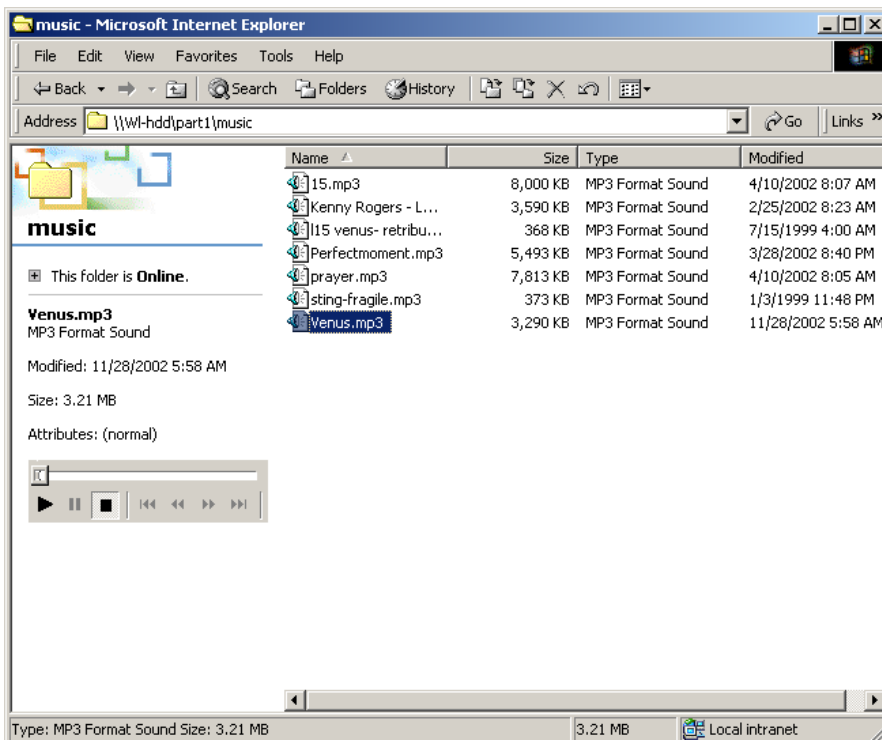

3. Select the music file that you want to play and double-click it to start playing it with the default application (in this case, Windows Media Player). Alternatively, for Windows media files, click the **Play** button in the left pane to start playback.

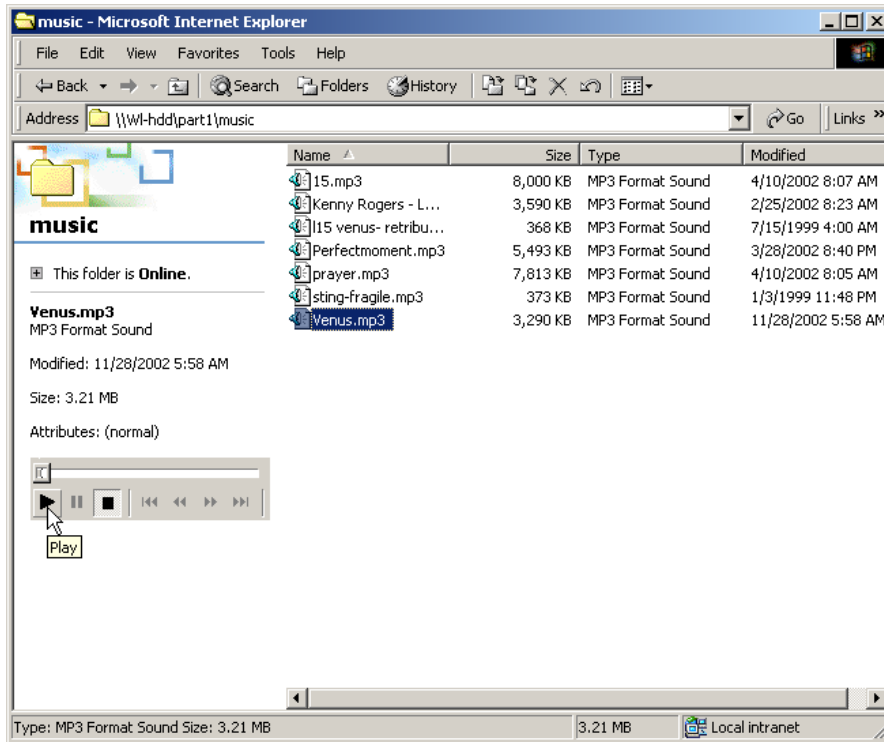

Transferring Data from External Flash Memory

The ASUS WL-HDD2.5 supports USB flash disks or external flash memory cards through a USB connection to enable you to transfer data. The device copies data automatically from the flash memory to the hard disk when inserted into the USB slot.

Auto-copy Function

To transfer data automatically from the flash memory, connect the USB flash memory disk to the USB port of the ASUS WL-HDD2.5. Alternatively, to transfer the contents of other types of flash memory cards such as CF, SD, MMC, and so on, insert the card into an external card reader (not supplied) and connect it to the USB port using a USB cable.

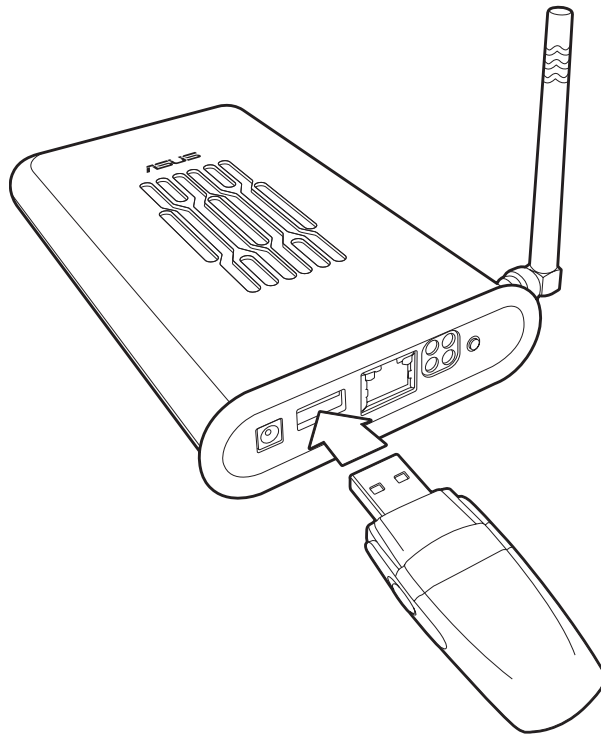

The device copies the contents of the memory disk automatically to the hard disk. The USB light blinks quickly when copying data.

The data from the USB flash memory is copied to a folder named **USBpartxxx**, where xxx is a number from 001 to 999 indicating the order in which the data was transferred.



Notes:

- When copying data automatically from a flash disk, the first partition – **part1** – is used first. All the data is copied as long as there is free space in the first partition.
 - If you remove the flash disk from the ASUS WL-HDD2.5 and insert it again, the data is copied again to the hard disk in a new folder with the folder name incremented by 1. For instance, if the first time the data was copied under **USBpart005**, then after removing and inserting the disk, the data is copied again to a new folder named **USBpart006**.
-

Locating the Copied Files on the HDD

To view the data transferred to the hard disk from your flash memory, double-click the hard drive partition (**part1**) icon (see “Accessing the HDD” on page 20 for more details). The contents of the flash memory are stored under the **USBpartxxx** folder (where xxx is a number from 001 to 999 indicating the order in which the data was transferred).

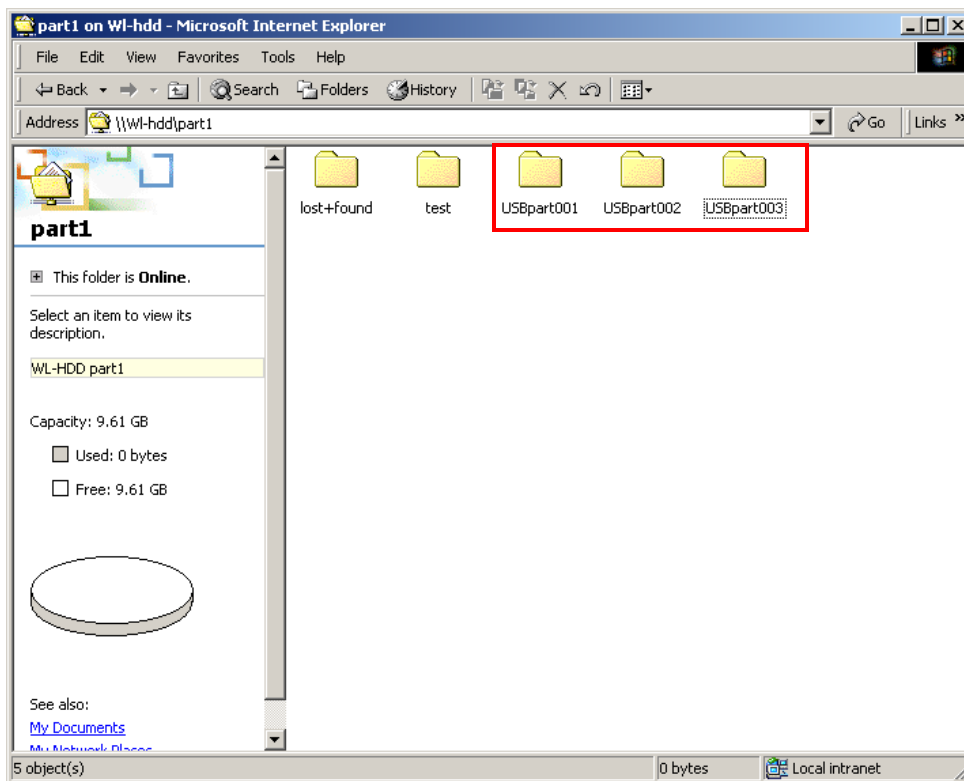

Shutting down the ASUS WL-HDD2.5

Use the web manager tool to shut down the ASUS WL-HDD2.5 after using it to prevent damage to the hard disk and loss of data. To shut down the system, do the following:

1. Click **Shutdown** in the web manager window.

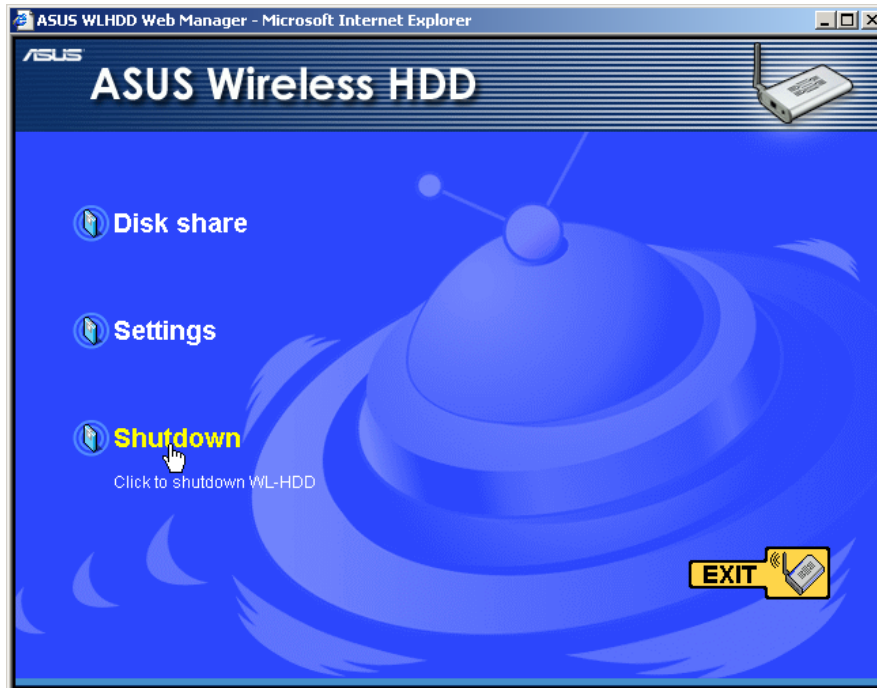

2. The device shuts down and the following message is displayed.

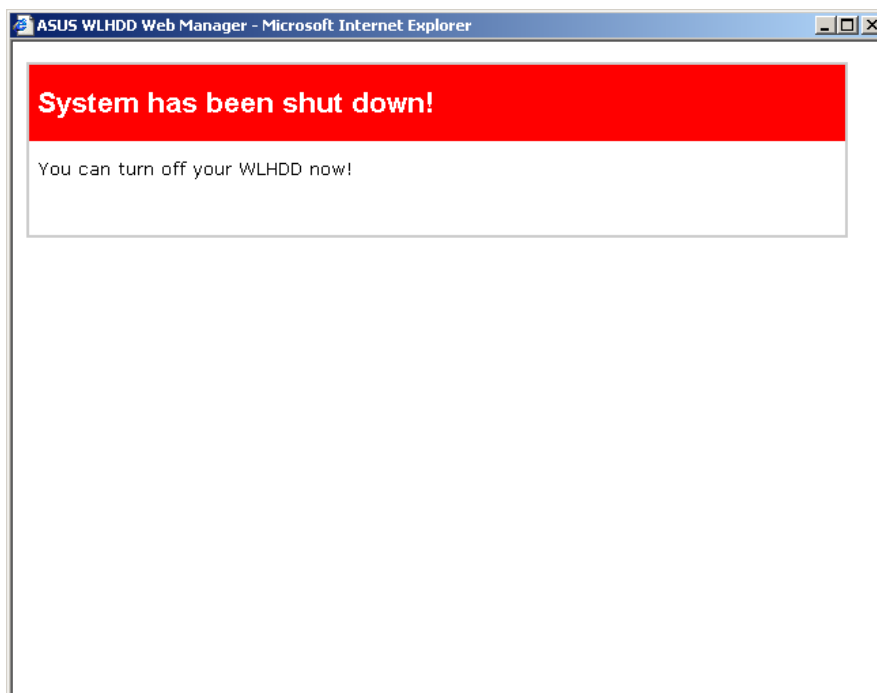

3. Disconnect the power cord and shut down the system safely.

3. Software Configuration

The ASUS WL-HDD2.5 can be configured to meet various usage scenarios. Some of the factory default settings may suit your usage; however, others may need to be changed.

Configuring the ASUS WL-HDD2.5 is done through a web browser. You need a PC connected to the ASUS WL-HDD2.5 (either directly or through a hub, with a wired or wireless connection) The web browser acts as a configuration terminal. For the wireless connection, you need an IEEE 802.11g/b compatible device, e.g. an ASUS WLAN Card, installed in your portable computer.

Connecting to the Web Interface

Wired Ethernet Connection

Besides using a network hub, you can also connect a LAN cable from your computer to the ASUS WL-HDD2.5 using either a straight or crossover cable because the device has auto-crossover capability.

Wireless Connection

If you are using a portable computer with a wireless adapter, you can connect to the ASUS WLAN Web Manager without a wired Ethernet connection. Just make sure your TCP/IP settings are configured correctly as described in “TCP/IP Settings” on page 16.

To configure the ASUS WL-HDD2.5, start your browser, type in the IP address of the device (192.168.1.1) in the **Address** box and click **Go**. The ASUS WL-HDD2.5 web manager opens. Click **Settings** to configure the device settings. A window pops up, prompting you to enter the User name and Password in order to log in. The factory default values are **admin** and **admin** for User name and Password. Click **OK** after typing in the required values.



Configuring the ASUS WL-HDD2.5

After logging in, the Wireless Hard Drive home page opens. Links to the various parameters that can be adjusted are shown in the left panel. Click a link to configure the ASUS WL-HDD2.5 as desired. Click **Restore** to clear the changes you have made and restore the previous settings. Click **Finish** to confirm all your settings and restart the ASUS WL-HDD2.5. Click **Apply** to confirm your settings and continue without restarting the device. The following sections describe the various configuration settings.



Wireless

Click the **Wireless** option on the left panel to display its submenus. The wireless menu enables you to configure the wireless interface of the ASUS WL-HDD2.5, to configure its bridge settings, to set up access blocks or bypass, and to enable the ASUS WL-HDD2.5 to act as an AP if no other AP is detected in its vicinity.

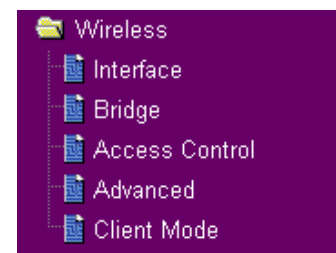

Interface

Wireless - Interface	
Region:	All ▾
SSID:	WL-HDD
Channel:	Auto ▾
Data Rate(Mbps):	Auto ▾
54g Mode:	Auto ▾ <input type="checkbox"/> 54g Protection
Authentication Method:	Open System or Shared Key ▾
Encryption:	None ▾
Passphrase:	██
WEP Key 1 (10 or 26 hex digits):	██
WEP Key 2 (10 or 26 hex digits):	██
WEP Key 3 (10 or 26 hex digits):	██
WEP Key 4 (10 or 26 hex digits):	██
Default Key:	Key1 ▾
Hide SSID:	<input type="radio"/> Yes <input checked="" type="radio"/> No
Basic Rate Set:	Default ▾
WPA Re-key Timer:	0
<input type="button" value="Restore"/> <input type="button" value="Finish"/> <input type="button" value="Apply"/>	
Restore:	Clear the above settings and restore the settings in effect.
Finish:	Confirm all settings and restart WLHDD now.
Apply:	Confirm above settings and continue.

The Interface submenu has the following options:

Region: Scroll through this drop-down box to select the appropriate region where you are located.

SSID: The SSID is an identification string of up to 32 ASCII characters unique to every AP. The SSID is also referred to as the “ESSID” or “Extended Service Set ID.” By default, the SSID is set to

“WL-HDD”. All the wireless clients in the vicinity must have the same SSID in order to use the ASUS WL-HDD2.5. This field is also used as the device name when you are looking for the ASUS WL-HDD2.5 through the Windows Network Neighborhood function.

Channel: The 802.11g and 802.11b specification supports up to 14 overlapping channels for radio communication. Choose an appropriate channel for the operating radio frequencies or choose **Auto** to select a channel automatically. The available channels change according to the **Region** selected.

Data Rate (Mbps): This field allows you to specify the transmission rate. Select **Auto** to maximize performance.

54g Mode: This field indicates the 802.11g interface mode. Selecting **Auto** allows both 802.11g and 802.11b clients to connect to the ASUS WL-HDD2.5. Selecting **54g Only** maximizes performance, but prevents 802.11b clients from connecting to the device. If **54g Protection** is checked, G-Mode protection of 802.11g traffic is enabled automatically in the presence of 802.11b traffic.

Authentication Method: This field enables you to set different authentication methods for determining various encryption schemes. The relationship between Authentication Method, Encryption, Passphrase and WEP Keys is listed in the following table:

Relationship among keys:

Authentication Method	Encryption	Passphrase	WEP Key 1~4
Open System or Shared Key	None	Not required	Not required
	WEP-64 bits	1~64 characters	10 hex digits
	WEP-128 bits	1~64 characters	26 hex digits
Shared Key	WEP-64 bits	1~64 characters	10 hex digits
	WEP-128 bits	1~64 characters	26 hex digits
WPA-PSK	TKIP only	8~63 characters	Not required
	AES only	8~63 characters	Not required

Encryption: If the **Open System** or **Shared Key** or **Shared Key** authentication method is used, WEP (Wired Equivalent Privacy) encryption is applied. If the **WPA-PSK** method is used, a newly proposed **TKIP** or **AES** encryption in WPA is applied.

Enabling WEP can protect your data from eavesdroppers. If you do not need this feature, select **None** to skip the following setting. The ASUS WL-HDD2.5 supports both 64-bit and 128-bit encryption using the WEP algorithm. Select the type of encryption you want to use (64 or 128 bit) and configure one to four WEP Keys. The **128-bit** method is more secure than the **64-bit** method.

64/128 bits versus 40/104 bits: You may be confused about configuring WEP encryption, especially when using multiple wireless LAN products from different vendors. There are two levels of WEP Encryption: 64 bits and 128 bits. 64-bit WEP and 40-bit WEP are the same encryption method and can inter-operate in the wireless network. This lower level of WEP encryption uses a 40 bit (10 hex digits [0~9, a~f, and A~F]) as a “secret key” (set by user), and a 24 bit “initialization vector” (not under user control). This together makes 64 bits (40 + 24). Some vendors refer to this level of WEP as 40 bits and others refer to this as 64 bits. Asus WLAN products use the term 64 bits when referring to this lower level of encryption. Secondly, 104 bit WEP and 128 bit WEP are the same encryption method and can inter-operate in the wireless network. This higher level of WEP encryption uses 104 bits (26 hex digits) as a “secret key” (set by user), and a 24 bit “initialization vector” (not under user control). This together makes 128 bits (104 + 24). Some vendors refer to this level of WEP as 104 bits and others refer to this as 128 bits. ASUS WLAN products use the term 128 bits when referring to this higher level of encryption.

Passphrase: If you select **TKIP only** or **AES only** as the Encryption method, this field will be used as a password for the encryption process. A password with 8 to 63 characters is required. If you select **WEP-64 bits** or **WEP-128 bits** as the Encryption method, this field will be used to generate four WEP keys automatically. A WEP key is either 10 or 26 hexadecimal digits based on whether you select 64 bit

or 128 bit in the WEP pull-down menu. Type a combination of up to 64 letters, numbers, or symbols in this field, which will be used to generate the four WEP keys. If you want to type in the keys manually, leave this field blank. The Asus WLAN family of products uses the same algorithm to generate the keys so that all the products can use the same WEP key.



Note: This function saves users from having to remember their passwords and is compatible for all ASUS WLAN products. However, this is not as secure as the manual assignment of the keys.

WEP Key: At most four WEP keys can be set. A WEP key is either 10 or 26 hexadecimal digits (0~9, a~f, and A~F) based on whether you select 64 bit or 128 bit in the WEP pull-down menu. The ASUS WL-HDD2.5 and ALL of its wireless clients **MUST** have the same default key.

Default Key: The Default Key field lets you specify which of the four encryption keys you use to transmit data on your wireless LAN. As long as the ASUS WL-HDD2.5 or a wireless mobile client with which you are communicating has the same key in the same position, you can use any of the keys as the default key. If the ASUS WL-HDD2.5 and ALL of its wireless clients use the same four WEP keys, select **key rotation** to maximize security. Otherwise, choose one key in common as the default key.

Hide SSID : By default, **No** is selected so that wireless mobile users can see your ASUS WL-HDD2.5's SSID and join the network. If **Yes** is selected, your ASUS WL-HDD2.5 will not show in site surveys by wireless mobile clients and they will have to manually enter your device's SSID. If you want to restrict access to your ASUS WL-HDD2.5, this is a simple way to do it.

Basic Rate Set: This field indicates the basic rates that wireless clients must support. Use **1 & 2 Mbps** only when backward compatibility is needed for some older wireless LAN cards with a maximum bit rate of 2 Mbps.

WPA Re-key Timer: This field specifies the time interval after which the WPA group key is changed in seconds. **0** means no periodic key-change is required.

Bridge

Wireless - Bridge

Wireless bridge (also known as Wireless Distribution System or WDS) function allows you to connect to one or many APs through wireless.



AP Mode:	AP Only ▾
Channel:	Auto ▾
Connect to APs in Remote Bridge List?	<input type="radio"/> Yes <input checked="" type="radio"/> No
Allow anonymous?	<input type="radio"/> Yes <input checked="" type="radio"/> No

Remote Bridge List
Add
Del

MAC Address

Restore
Finish
Apply

Restore:	Clear the above settings and restore the settings in effect.
Finish:	Confirm all settings and restart WLHDD now.
Apply:	Confirm above settings and continue.

The bridge or WDS (Wireless Distribution System) enables you to connect to one or many APs through a wireless connection. Choose an AP mode and configure the WDS settings as follows:

AP Mode: AP Mode configures the ASUS WL-HDD2.5 for a specific purpose. By default, the device is set to serve as an Access Point (**AP only**) where a wireless mobile client can connect wirelessly to a wired Ethernet network. Choose **WDS only** for communicating with other APs. **Hybrid** allows you to use the device both as an AP as well as a wireless bridge.

Channel: All the Access Points in a Wireless Bridge mode must be set to the same channel. The channel is set to 1 for WDS and Hybrid AP modes.

Connect to APs in Remote Bridge List (Yes/No): Select **Yes** to connect to access points in the remote bridge list.

Allow anonymous? (Yes/No): Select **Yes** to allow users without accounts to connect to the AP.



Note: If **Connect to APs in Remote Bridge List** and **Allow Anonymous** are both set to **No**, it means that this AP will not connect with other APs and therefore the AP mode setting is set automatically to **AP Only**.

Remote Bridge List: Use the remote bridge list to set up the MAC addresses of the devices in the wireless bridge. Enter the MAC address of the target APs in order to designate partners for your device. Click **Add** to add the address or click **Del** to delete a selected address.

Access Control

Wireless - Access Control

Access Control allows you to block the access from certain wireless stations or to bypass access from certain wireless stations only. In Accept mode, WLHDD will only accept wireless access from stations with MAC address in the control list. In Reject mode, WLHDD will reject wireless access from stations with MAC address in the control list.

MAC Access Mode:

Access Control List

MAC Address
<input type="text"/>
<input type="text"/>
<input type="text"/>
<input type="text"/>
<input type="text"/>

Restore:	Clear the above settings and restore the settings in effect.
Finish:	Confirm all settings and restart WLHDD now.
Apply:	Confirm above settings and continue.

For additional security, the ASUS WL-HDD2.5 has the ability to only associate with or not associate with wireless mobile clients that have their MAC address specified in this menu. The Access Control menu enables you to block the access from certain wireless stations or to bypass access from certain wireless stations. The menu has the following options:

MAC Access Mode: The default setting of **Disable** allows any wireless mobile client to connect to this device. The **Accept** option only allows clients with their MAC addresses specified in the Access Control List, to connect to the device. The **Reject** option prevents devices with their MAC addresses specified in the Access Control List from connecting to this device.

Access Control List: To add a MAC address to the Access Control List, enter the 12 hexadecimal digits into the white box under **MAC Address** and click the **Add** button. The MAC address will be placed in the control list below. A total of 31 MAC addresses can be entered into this page. For optimum use, determine which will be the lesser value; addresses you wish to accept connections from, or addresses you wish to reject connections from. Then, choose the appropriate **MAC Access Mode**.

Advanced

Wireless - Advanced	
This section allows you to set up additional parameters for wireless. But default values are recommended.	
Fragmentation Threshold:	<input type="text" value="2346"/>
RTS Threshold:	<input type="text" value="2347"/>
DTIM Interval:	<input type="text" value="3"/>
Beacon Interval:	<input type="text" value="100"/>
Enable Frame Bursting?	<input type="radio"/> Yes <input checked="" type="radio"/> No
<input type="button" value="Restore"/> <input type="button" value="Finish"/> <input type="button" value="Apply"/>	
Restore:	Clear the above settings and restore the settings in effect.
Finish:	Confirm all settings and restart WLHDD now.
Apply:	Confirm above settings and continue.

The Advanced menu allows you to set up additional settings for the ASUS WL-HDD2.5. However, it is recommended that you use the default values for correct operation.

Fragmentation Threshold (256~2346): Fragmentation is used to divide 802.11 frames into smaller pieces (fragments) that are sent separately to the destination. The use of fragmentation can increase the reliability of frame transmissions. This field allows you to enable fragmentation by setting a specific packet size threshold. The default value (2346) is recommended.

RTS Threshold (0~2347): The RTS/CTS (Request to Send/Clear to Send) function is used to minimize collisions among wireless stations. If you enable RTS/CTS, it will refrain from sending a data frame until another RTS/CTS handshake in the air is completed. This field allows you to enable RTS/CTS by setting a specific packet size threshold. Default value 2347 is recommended.

DTIM Interval (1~255): DTIM (Delivery Traffic Indication Message) is a kind of wireless message used to inform clients in Power Saving Mode when to wake up to receive broadcast and multicast messages. This field indicates the time interval in multiples of the Beacon Interval that the system broadcasts DTIMs for clients in Power Saving Mode. The default value (3) is recommended.

Beacon Interval (1~65535): This field indicates the time interval in milliseconds after which the system broadcast packet, called beacon, is sent to synchronize the wireless network. The default value (100 milliseconds) is recommended.

Enable Frame Bursting? This field allows you to enable frame-bursting mode to improve performance with wireless clients that also support frame bursting.

Client Mode

Wireless - Client Mode				
Wireless Client mode allows you to connect to AP through wireless.				
Become an AP if no AP can be connected?	<input checked="" type="radio"/> Yes <input type="radio"/> No			
Client Mode:	Disabled ▾			
Preferred AP	None ▾			
Profile List				
<input type="button" value="Add"/> <input type="button" value="Del"/> <input type="button" value="Edit"/>				
<table border="1"><thead><tr><th>SSID</th></tr></thead><tbody><tr><td><input type="text"/></td></tr><tr><td><input type="text"/></td></tr></tbody></table>		SSID	<input type="text"/>	<input type="text"/>
SSID				
<input type="text"/>				
<input type="text"/>				
<input type="button" value="Restore"/> <input type="button" value="Finish"/> <input type="button" value="Apply"/>				
Restore:	Clear the above settings and restore the settings in effect.			
Finish:	Confirm all settings and restart WLHDD now.			
Apply:	Confirm above settings and continue.			

This menu page enables you to connect to the AP using a wireless connection and has the following options:

Become an AP if no AP can be connected? Click **Yes** to enable the ASUS WL-HDD2.5 to be an Access Point in a wireless network, if no other AP is detected.

Client Mode: Select **Disabled** if you do not want to connect to other APs in the network. Select **Connect to AP in profiles** to enable the device to connect to the APs specified in the Profile List.

Preferred AP: Scroll through this drop-down box to specify which AP (from the Profile List) should be given preference when connecting to other APs.

Profile List: Use this option to add the SSIDs of other APs in the WLAN, to which the ASUS WL-HDD2.5 connects. Type the SSID of the AP under the **SSID** field, then click **Add** to add it to the Profile List. Select an existing AP SSID, then click **Del** to remove it from the list and disable connection to it. Select an existing AP SSID and click **Edit** to modify its connection parameters as follows:

Wireless - Client Mode	
SSID	<input type="text" value="3com1"/>
Channel	<input type="text" value="Auto"/>
Network Type	<input type="text" value="Infra Structure"/>
Authentication Method	<input type="text" value="Open System"/>
Encryption Type	<input type="text" value="None"/>
Passphrase	<input type="password"/>
WEP Key 1	<input type="password"/>
WEP Key 2	<input type="password"/>
WEP Key 3	<input type="password"/>
WEP Key 4	<input type="password"/>
Default Key	<input type="text" value="Key1"/>
<input type="button" value="Apply"/>	
Apply:	Confirm above settings and continue.

SSID: Type the SSID of the AP in this field.

Channel: Scroll through this drop-down box to specify the channel for this AP. Auto is the default option.

Network Type: Specify if the network consists of other APs by selecting the **Infrastructure** option or choose **Ad Hoc** if the network consists of direct connections between computers.

Authentication Method: This option enables you to set the authentication method for various encryption schemes for the selected AP. Choose **Open System** or **Shared Key** depending on the AP's encryption system. The authentication method for the AP should be the same as that chosen for the ASUS WL-HDD2.5 (see "Authentication Method" on page 47).

Encryption Method: Select WEP - 64 bits or WEP - 128 bits for the encryption method to protect your data by encrypting it. The encryption scheme for the AP should be the same as that chosen for the ASUS WL-HDD2.5 (see "Encryption" on page 48).

Passphrase: Type in the passphrase that will be used to create one to four WEP encryption keys. A password with 8 to 63 characters is required. If you leave this field blank, the WEP keys are randomly generated.

WEP Keys (1 ~ 4): The WEP keys are generated randomly or based on your passphrase. A WEP key is either 10 or 26 hexadecimal digits (0~9, a~f, and A~F) based on whether you select 64 bit or 128 bit in the WEP pull-down menu.

Default Key: The Default Key field lets you specify which of the four encryption keys you use to transmit data on your wireless LAN. The selected AP and ALL of its wireless clients MUST have the same default key.

IP Config

Click the **IP Config** option on the left panel to display its submenus. The IP Config submenus provide options for your LAN and DHCP settings as described in the following sections.

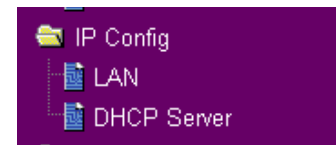

LAN

IP Config - LAN	
LAN IP Setting	
Get IP Automatically?	<input type="radio"/> Yes <input checked="" type="radio"/> No
IP Address:	<input type="text" value="192.168.1.1"/>
Subnet Mask:	<input type="text" value="255.255.255.0"/>
Default Gateway:	<input type="text"/>
Restore Finish Apply	
Restore:	Clear the above settings and restore the settings in effect.
Finish:	Confirm all settings and restart WLHDD now.
Apply:	Confirm above settings and continue.

The LAN menu page has the following settings:

Get IP Automatically: Select **Yes** (default) or **No** to get an IP address automatically from a DHCP server.

If you select **Yes**, this means that the ASUS WL-HDD2.5 will send out a DHCP request during bootup. If you have a DHCP (Dynamic Host Configuration Protocol) server on the network, set this option so that the ASUS WL-HDD2.5 can receive an automatic IP address and subnet mask assignment. The DHCP server automatically assigns the ASUS WL-HDD2.5 an IP address when it is powered up. To determine what settings have been assigned to the ASUS WL-HDD2.5, check the Status page (see “Status” on page 67).

If you select **No**, the ASUS WL-HDD2.5 accepts a static IP address. You can manually configure the IP address and subnet mask in this case. Enter an IP address and a subnet mask in the field provided to assign the ASUS WL-HDD2.5 a static IP address. If you don't know your Gateway setting, leave it empty (not 0.0.0.0).

DHCP server

IP Config - DHCP Server	
WLHDD supports up to 253 IP addresses for your local network. The IP address of a local machine can be assigned manually by the network administrator or obtained automatically from WLHDD if the DHCP server is enabled. This DHCP Server is useful while you use WLHDD as a standalone device. But, if you want to use WLHDD in your network with other DHCP server, please disable this function.	
Enable the DHCP Server Automatically?	<input checked="" type="radio"/> Yes <input type="radio"/> No
Domain Name:	<input type="text"/>
IP Pool Starting Address:	<input type="text" value="192.168.1.100"/>
IP Pool Ending Address:	<input type="text" value="192.168.1.150"/>
Lease Time:	<input type="text" value="86400"/>
<input type="button" value="Restore"/> <input type="button" value="Finish"/> <input type="button" value="Apply"/>	
Restore:	Clear the above settings and restore the settings in effect.
Finish:	Confirm all settings and restart WLHDD now.
Apply:	Confirm above settings and continue.

The ASUS WL-HDD2.5 is set up to be a DHCP server by default. This enables it to support up to 254 IP addresses on the WLAN. The IP address for a wireless client can be designated by the network administrator or can be assigned by the ASUS WL-HDD2.5 automatically. The following options are available on this page:

Enable the DHCP Server Automatically: Select **Yes** to enable the DHCP server and **No** to disable it automatically.

Domain Name: Type a domain name that will be used by the DHCP clients.

IP Pool Starting Address: Type the IP address of the first device in the group of DHCP clients. Make sure that it is on the same subnet mask as the ASUS WL-HDD2.5.

IP Pool Ending Address: Type the IP address of the last device in the group of DHCP clients. Make sure that it is on the same subnet mask as the ASUS WL-HDD2.5.

Lease Time: Type in the period of time over which a DHCP client can lease an IP address.

Storage Setting

Click the **Storage Setting** option on the left panel to display its submenus. The Storage Setting menus enable you to configure the various parameters of the HDD that is shared on the WLAN. Refer to the following sections for more details.

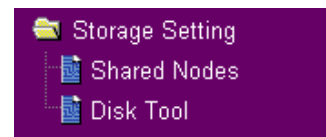

Shared Nodes

Storage Setting - Shared Nodes

Network Neighborhood Mode:	Share all partitions in disk ▾
Work Group:	Mygroup
FTP Mode:	Login to first partition ▾
Maximum Login User:	6

Shared Nodes List

Folders and Partitions	part1/ ▾		
Path	Shared Name	Shared	Write
part1/	part1	<input type="checkbox"/>	<input type="checkbox"/>
part2/ part1/USBpart001	part2 music	on on	on

User List

User Name	Password
<input type="text"/>	<input type="text"/>
user1	pass1
user2	pass2

Restore: Clear the above settings and restore the settings in effect.

Finish: Confirm all settings and restart WLHDD now.

Apply: Confirm above settings and continue.

The Shared Nodes menu page enables you to set the sharing rights and privileges for the shared partitions on the HDD of the ASUS WL-HDD2.5. The following options are available:

Network Neighborhood Mode: Select the default setting of **Share all partitions on disk** to enable sharing of all partitions on the disk.

Work Group: Specify the name of the work group to which the device belongs. The default is **Mygroup**.

FTP Mode: Select the FTP Mode to specify which partitions is the default when used by FTP clients for logging in.

Maximum Login User: Specify the maximum number of users that can log in to access the HDD and its partitions. The default is 6.

Shared Nodes List: This option enables you set up the various partitions on the HDD. The partitions are all Linux partitions. Enter in the path for a folder or partition to be shared under **Path**. Type in a name for the partition under **Shared Name** that will be used by wireless clients when accessing the HDD. Click the **Shared** check box to enable sharing of the selected folder. Click the **Write** check box to enable writing access of the selected folder. Click **Add** to create the partition. To edit the properties of an existing partition, scroll through the **Folders and Partitions** drop-down box to choose a partition for making changes. Make the changes desired, then click **Edit** to save your changes. Click **Del** after selecting a partition to delete it.

User List: You can specify which users can access your HDD by creating a user list. Type in a name under **User Name** and its password under **Password**. Only the users specified in this list will be able to access the HDD. Click **Add** to add the user and **Del** to delete a selected user in the list.

Disk Tool

Storage Setting - Disk Tool	
The Disk Tool allows you to format a new disk and create up to 4 partitions on it. Any data on the disk will be lost if format operation is performed.	
Disk Space(MB):	<input type="text" value="19077"/>
Disk Space of Partition 1(MB):	<input type="text"/>
Disk Space of Partition 2(MB):	<input type="text"/>
Disk Space of Partition 3(MB):	<input type="text"/>
Disk Space of Partition 4(MB):	<input type="text"/>
<input type="button" value="Apply"/>	

The Disk Tool enables you to specify the sizes of the partitions on the HDD. You can create up to 4 partitions on the HDD. The total disk space is specified in the **Disk Space** field. Enter the size in MB for each of the desired partitions in the **Disk Space of Partition x** (where x goes from 1 through 4) fields.



Warnings:

- Any data on the hard disk will be lost after creating new partitions. Make sure that the data is backed up before using this tool.
- The hard disk is formatted using Linux partitions (EXT2). It cannot be connected directly to a Windows system without reformatting. Reformatting will erase all your data.



Note: We recommend that you format the hard disk at least once before using it.

System Setting

Click the **System Setting** option on the left panel to display its submenus. This set of menus enables you to make changes to the system parameters of the ASUS WL-HDD2.5. You can change the password, upgrade the firmware from a file provided by Asus, or restore the device to its default factory settings using this set of menus.

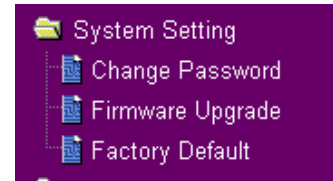

Change Password

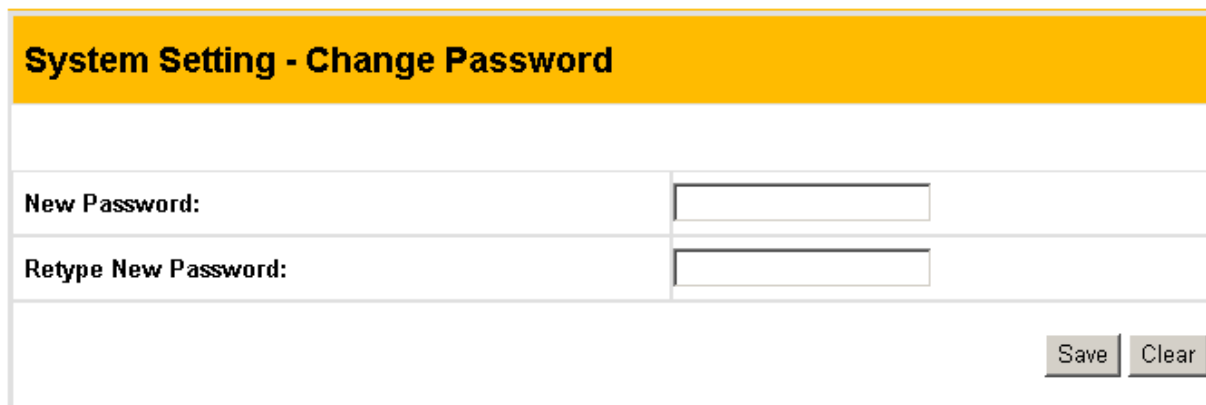
A screenshot of a web form titled 'System Setting - Change Password'. The form has a yellow header bar with the title. Below the header are two input fields: 'New Password:' and 'Retype New Password:'. At the bottom right of the form are two buttons: 'Save' and 'Clear'.

The Change Password menu allows you to change the system password of the ASUS WL-HDD2.5. (The default password is **admin**.) To change the password, enter the new password in the **New Password** field and enter it again for confirmation in the **Retype New Password** field. Click **Save** to confirm your changes. You can enter any password between 1-16 characters long (cannot be left blank). If you forget the password at any time, you can use the Factory Default menu (see “Factory Default” on page 66) to restore the password to its default (**admin**) value.



Note: The password is case sensitive.

Firmware Upgrade

System Setting - Firmware Upgrade

Follow instructions listed below:

1. Check if any new version of firmware is available on ASUS website.
2. Download a proper version to your local machine.
3. Specify the path of and name of the downloaded file in the "New Firmware File".
4. Click "Upload" to upload the file to WLHDD. It spends about 10 seconds.
5. After receiving a correct firmware file, WLHDD will automatically start the upgrade process. It takes a few time to finish the process and then the system will reboot.

Product ID:	<input type="text" value="WLHDD"/>
Firmware Version:	<input type="text" value="1.1.2.0"/>
New Firmware File:	<input type="text"/> <input type="button" value="Browse..."/>
	<input type="button" value="Upload"/>

Note:

1. For a configuration parameter existing both in the old and new firmware, its setting will be kept during the upgrade process.
2. In case the upgrade process fails, WLHDD will enter an emergent mode automatically. The LED signals at the front of WLHDD will indicate such situation. Use the Firmware Restoration utility on the CD to do system recovery.

The Firmware Upgrade menu enables you to upload new firmware upgrades to the ASUS WL-HDD2.5. Follow the instructions on the screen to upgrade the firmware. The menu page displays the device name under **Product ID** and the current Flash Code (Firmware) version installed in the device under **Firmware Version**. Periodically, a new Flash Code is available for the ASUS 802.11g APs on ASUS's Web site. Click **Browse** to specify the location of the new firmware file provided by the manufacturer. Click **Upload** to start uploading.



Note: The firmware upgrade takes approximately 80 seconds. The device reboots after the upload is complete. When the firmware upgrade is completed, you will be directed to the home page menu automatically.

Factory Default

System Setting - Factory Default

Click the **Restore** button to clear all settings and restore the factory defaults. Then, wait for the home gateway to reboot.

Restore

Use this menu to restore the ASUS WL-HDD2.5 to its default factory settings. Click the **Restore** button to clear all settings and restore the factory defaults. The device reboots after this function.



Note: You can also clear all settings and restore factory default values by pressing and holding down the Reset button for 5 seconds.

Status and Log

Click the **Status and Log** option on the left panel to display its submenus. These submenus enable you to view the status and a log report of the ASUS WL-HDD2.5. Various system parameters are displayed on the Status page.

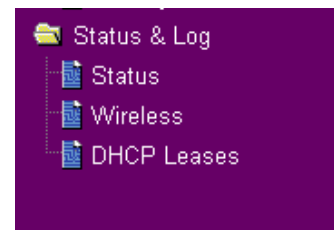

Status

Status & Log - Status	
System Time:	Mon, 13 Mar 1922 14:30:56 UTC-00:00 <input type="button" value="Sync"/>
Disk	
Model Name:	IC25N020ATMR04-0
Size of Partitions(MegaBytes):	10001;9075;free: 1
Status:	File system ready
Action:	<input type="button" value="File System Check"/>
LAN Interface	
IP Address:	192.168.1.1
Subnet Mask:	255.255.255.0
Default Gateway	
<input type="button" value="Refresh"/>	

The Status submenu displays the following settings:

System Time: This field displays the current system time of the ASUS WL-HDD2.5. Click **Sync** to synchronize the system with that of your wireless client.

Disk: The disk properties of the HDD are displayed in this part of the menu page. The **Model Name**, **Size of Partitions** in megabytes along with the number of free partitions, and File System **Status** are shown. Click **File System Check** under **Action** to check the status of the file system. This verifies that the file system on the HDD is intact and not corrupt. The screen displays the status while the file system is being checked.

DISK Utilities
DISK tool is working, please wait for the next instruction ...
Status
checking part1 pass:1: 29%

LAN Interface: The LAN Interface displays the **IP Address**, **Subnet Mask**, and **Default Gateway** (if any) for the ASUS WL-HDD2.5.

Wireless

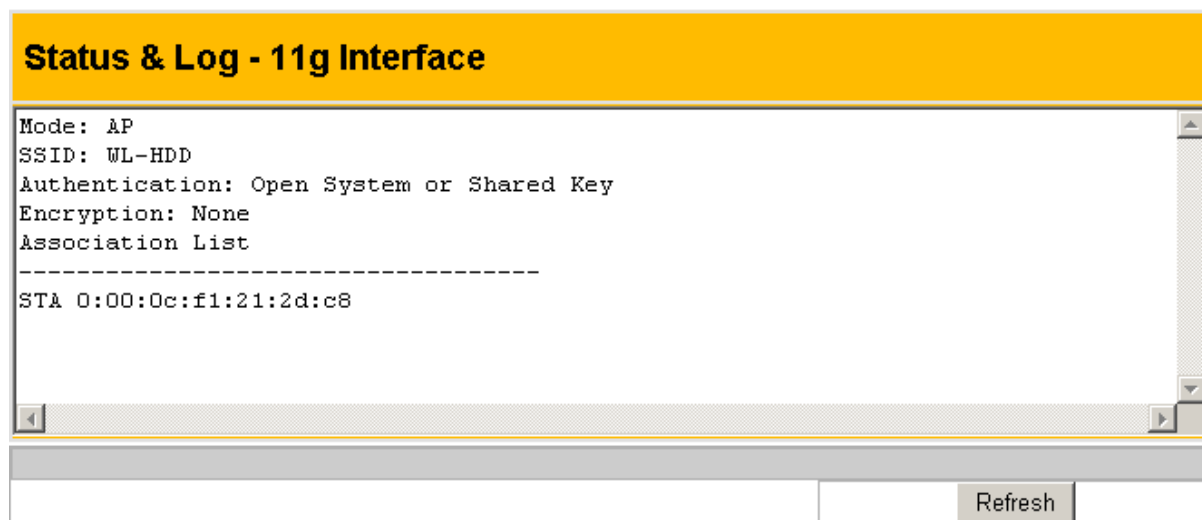

The Wireless submenu (11g Interface) displays a log of activities performed on the device. Any settings changed are displayed in this log file.

DHCP Leases

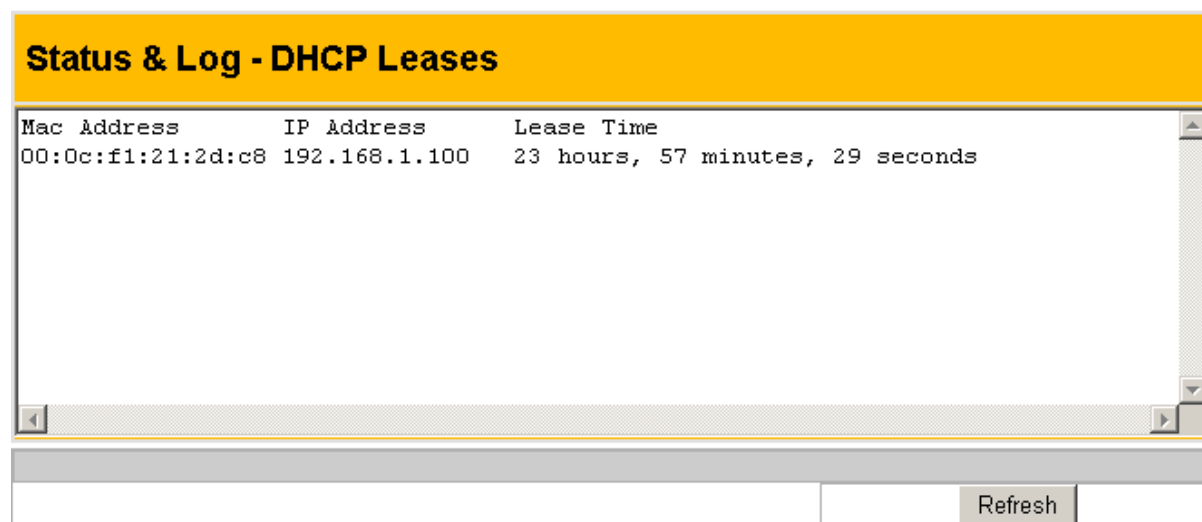

The DHCP Leases log file shows a list of devices (clients) that access the ASUS WL-HDD2.5 when DHCP is enabled. The MAC address of each device, along with its IP address and lease time are displayed in this log file.

4. Troubleshooting

Refer to the following tips to resolve any problems that you may encounter when using the ASUS WL-HDD2.5.

1. The ASUS WL-HDD2.5 cannot be found using the **Search for computer** technique.
 - Use the **Device Discovery** tool of the wireless utility on your wireless client to search for the WL-HDD. If the WL-HDD is found with a different subnet mask from your client, set the IP of your client to the same subnet.
 - If the ASUS WL-HDD2.5 is not found using **Device Discovery**, please check your network connection.
2. Only the **Configuration** folder found on the WL-HDD.
 - Check if the hard disk drive is mounted correctly on the ASUS WL-HDD2.5.
 - Check if the hard disk drive is formatted.
 - Check if the partitions and folders are shared using the **Shared Nodes** utility (see “Shared Nodes” on page 61).
3. Shared folders cannot be accessed using Windows 98 or Windows Me.
 - If you use Windows 98 or Windows Me to access the shared folders that are protected by username and password, you can only view the contents of the folder which uses the same username and password pair as your wireless client.

5. Appendix

Specifications

LAN Ethernet port	Support	Ethernet and 802.3 with maximum bit rate 10/100 Mbps and auto cross-over function (MDI/MDI-X)
	Connector	1 x RJ-45 for 10/100BaseT
Antenna	Support	2 (One internal inverted-F PCB antenna and one external dipole antenna)
	Connector	Reverse-SMA antenna connector
LED	<ul style="list-style-type: none">• Power x 1• HDD access x 1• Wireless activity x 1• USB copy x 1• LAN port x 2 (Ethernet Link/Activity with 10/100 Mbps)	
USB	USB 1.1	
RTC	Supports real time clock	
Reset button	Push for 5 seconds to restore factory settings.	
Hard disk drive	2.5-inch slim attachable hard drive	
IDE controller	<ul style="list-style-type: none">• Ultra DMA 100• Conforms to ATA-5 specifications	
DC power adapter	<ul style="list-style-type: none">• AC input: 100V~240V (50~60 Hz)• DC output: 5V with maximum 3A current	
Emissions	CE mark, FCC Part 15	
Size	180 mm x 90 mm x 25 mm	
Weight	200g	
Operating frequency	2.4 - 2.5 GHz	
Spreading	OFDM and DSSS	
Modulation	OFDM, CCK, DQPSK, DBPSK	
Data rate	<ul style="list-style-type: none">• 802.11g: 6, 9, 12, 18, 24, 26, 54 Mbps• 802.11b: 1, 2, 5.5, 11 Mbps	

Operation channels	11 for North America, 14 for Japan, 13 for Europe, 3 for non-overlapping	
Range	<ul style="list-style-type: none"> Indoor 130 ft. (40m), outdoor (Line-of-Sight) 300 ft. (100m) at 11 Mbps. Indoor 80 ft. (25m), outdoor (Line-of-Sight) 200 ft. (60m) at 54 Mbps. 	
Output power	<ul style="list-style-type: none"> 802.11g: 13 ~ 16 dBm (at normal temperature range) 802.11b: 13 ~ 15 dBm (at normal temperature range) 	
Encryption	64/128 bit WEP, WPA-PSK, WPA	
Network protocols	<ul style="list-style-type: none"> HTTP server UPnP (upgradeable) DHCP client TCP/IP Samba server FTP server DHCP server 	
Web server	<ul style="list-style-type: none"> HTTP based Dynamic or static address 	
Utilities	<ul style="list-style-type: none"> Device discovery Firmware restoration: Restore the firmware while system enters rescue mode. 	
Management	Web-based configuration	<ul style="list-style-type: none"> Internet Explorer 6 or later Netscape Navigator 6 or later Other Java-enabled browsers
	System settings	<ul style="list-style-type: none"> Server name Workgroup (upgradeable) Time zone and current time DHCP and static IP Auto IP
	Folder access	<ul style="list-style-type: none"> Shared Password setting Read or Read and Write
	System tools	<ul style="list-style-type: none"> Reboot Shutdown Format Scan disk Firmware upgrade

HDD functionality and limitations

Supported file systems

FAT, FAT32, NTFS (read-only), EXT2, EXT3

Supported disk size

Less than 40GB

Supported file size

Less than 2GB

System tool

- File system check for EXT2 only
- Format and partition for EXT2 only

Supported USB flash

USB flash identified as USB mass storage. External power is required for USB hard disk.
