



DG-WM2005SI

300Mbps CEILING MOUNT ACCESS POINT

User Manual

V1.0

2014-05-14

As our products undergo continuous development the specifications are subject to change without prior notice

Table of contents

1. INTRODUCTION	6
1.1 PACKAGE CONTENTS.....	6
1.2 HARDWARE INSTALLATION.....	8
1.2.1 WARNING	8
1.2.2 SYSTEM REQUIREMENTS.....	8
1.2.3 Hardware Configuration	10
1.2.4 Mounting on the Ceiling / Wall.....	11
1.2.5 LED Indicators.....	13
1.2.6 Button Definition	15
2.1 EASY SETUP VIA WEB UI	19
2.2 USE WEC BUTTON TO SETUP WIRELESS PROFILES	23
2.2.1 One Master and several isolated Slaves.....	23
2.2.2 One Master and a series of connected Slaves	25
3 MAKING CONFIGURATIONS.....	28
3.1 BASIC NETWORK.....	30
3.1.1 Ethernet LAN.....	30
3.1.2 Wireless.....	31
3.1.2.1 Wireless Setup	32
3.1.2.1.1 AP Only Mode	32
3.1.2.1.2 WDS Hybrid Mode.....	36
3.1.2.1.3 WDS Only Mode.....	40
3.1.2.1.4 Universal Repeater Mode.....	43
3.1.3 Advanced Wireless Setup	45
3.1.3.1 Advanced RF Module1/Wireless Settings	45
3.1.4 IPv6	47
3.2 ADVANCED NETWORK	48
3.2.1 Firewall	49
3.2.1.1 MAC Address Control.....	49
3.2.2 Management	50
3.2.2.1 UPNP	50
3.2.2.2 SNMP.....	51

3.3 SYSTEM.....	53
3.3.1 System Information	54
3.3.2 System Status	54
3.3.2.1 Web Log.....	54
3.3.2.2 Syslog	55
3.3.2.3 Email Alert.....	55
3.3.3 System Tools	56
3.3.3.1 Change Password.....	56
3.3.3.2 FW Upgrade.....	57
3.3.3.3 System Time	58
3.3.3.4 Others	59
3.3.4 MMI.....	60
3.3.4.1 Web UI	60
4 TROUBLESHOOTING	61
APPENDIX A. ASSIGNING A STATIC IP IN WINDOWS PC.....	65

COPYRIGHT

Copyright 2014 by Smartlink Network Systems Ltd. All rights reserved. No part of this publication may be reproduced, transmitted, transcribed, stored in a retrieval system, or translated into any language or computer language, in any form or by any means, electronic, mechanical, magnetic, optical, chemical, manual or otherwise, without the prior written permission of this company.

This company makes no representations or warranties, either expressed or implied, with respect to the contents hereof and specifically disclaims any warranties, merchantability or fitness for any particular purpose. Any software described in this manual is sold or licensed "as is". Should the programs prove defective following their purchase, the buyer (and not this company, its distributor, or its dealer) assumes the entire cost of all necessary servicing, repair, and any incidental or consequential damages resulting from any defect in the software. Further, this company reserves the right to revise this publication and to make changes from time to time in the contents thereof without obligation to notify any person of such revision or changes.

Trademarks:

DIGISOL™ is a trademark of Smartlink Network Systems Ltd. All other trademarks are the property of the respective manufacturers.

FCC Interference Statement

This equipment has been tested and found to comply with the limits for a Class B digital device pursuant to Part 15 of the FCC Rules. These limits are designed to provide reasonable protection against radio interference in a commercial environment. This equipment can generate, use and radiate radio frequency energy and, if not installed and used in accordance with the instructions in this manual, may cause harmful interference to radio communications. Operation of this equipment in a residential area is likely to cause interference, in which case the user, at his own expense, will be required to take whatever measures are necessary to correct the interference.

CE Declaration of Conformity

This equipment complies with the requirements relating to electromagnetic compatibility, EN 55022/A1 Class B.

1. Introduction

Congratulations on your purchase of this outstanding product: APC772-001 WiFi 2.4G N 300 Ceiling Access Point are designed for small- and medium-sized businesses to extend the existing wired networks and has the ability to operate in different modes and can be used in a wide variety of wireless applications like AP, Point-to-Point. Universal



Repeater Mode not only has an easier setup method, but also provides better performance and compatibility to creates a virtually larger wireless network infrastructure by linking up other access points.

Support Multiple-SSID capability to use one Physical AP to simultaneously emulate 8 APs with different ESSIDs by separate their packets via VLAN technology.

1.1 Package Contents

Before using this access point, please check if there is anything missing in the package, and contact your dealer of purchase to claim for missing items:

- Ceiling Access Point
- DC 12V Power Adapter
- Patch Cord
- Installation Guide CD

Items	Description	Contents	Quantity
1	WiFi 2.4G N300 Ceiling AP		1 No.
2	Power Adapter		1 No.

3	RJ45 Cable		1 No.
4	Installation Guide CD		1 No.

1.2 Hardware Installation

1.2.1 WARNING



Attention

- Do not use the product in high humidity or high temperatures.
- Do not use the same power source for the Product as other equipment. Only use the power adapter that comes with the package. Using a different voltage rating power adaptor may damage the device.
- Do not open or repair the case yourself. If the Product is too hot, turn off the power immediately and have it repaired at a qualified service center.
- Place the Product on a stable surface and avoid using this product and all accessories outdoors.

1.2.2 SYSTEM REQUIREMENTS

Network Requirements	<ul style="list-style-type: none"> • An Ethernet-based Cable or DSL modem • IEEE 802.11n or 802.11b, g wireless clients • 10/100 Ethernet
Web-based Configuration Utility Requirements	<p>Computer with the following:</p> <ul style="list-style-type: none"> • Windows®, Macintosh, or Linux-based operating system • An installed Ethernet adapter <p>Browser Requirements:</p> <ul style="list-style-type: none"> • Internet Explorer 6.0 or higher • Chrome 2.0 or higher • Firefox 3.0 or higher • Safari 3.0 or higher (with Java 1.3.1 or

	higher) Windows® Users: Make sure you have the latest version of Java installed. Visit www.java.com to download the latest version.
CD Installation Wizard Requirements	Computer with the following: <ul style="list-style-type: none">• Windows® 7, Vista®, or XP with Service Pack 2• An installed Ethernet adapter• CD-ROM drive

1.2.3 Hardware Configuration

Rear View:

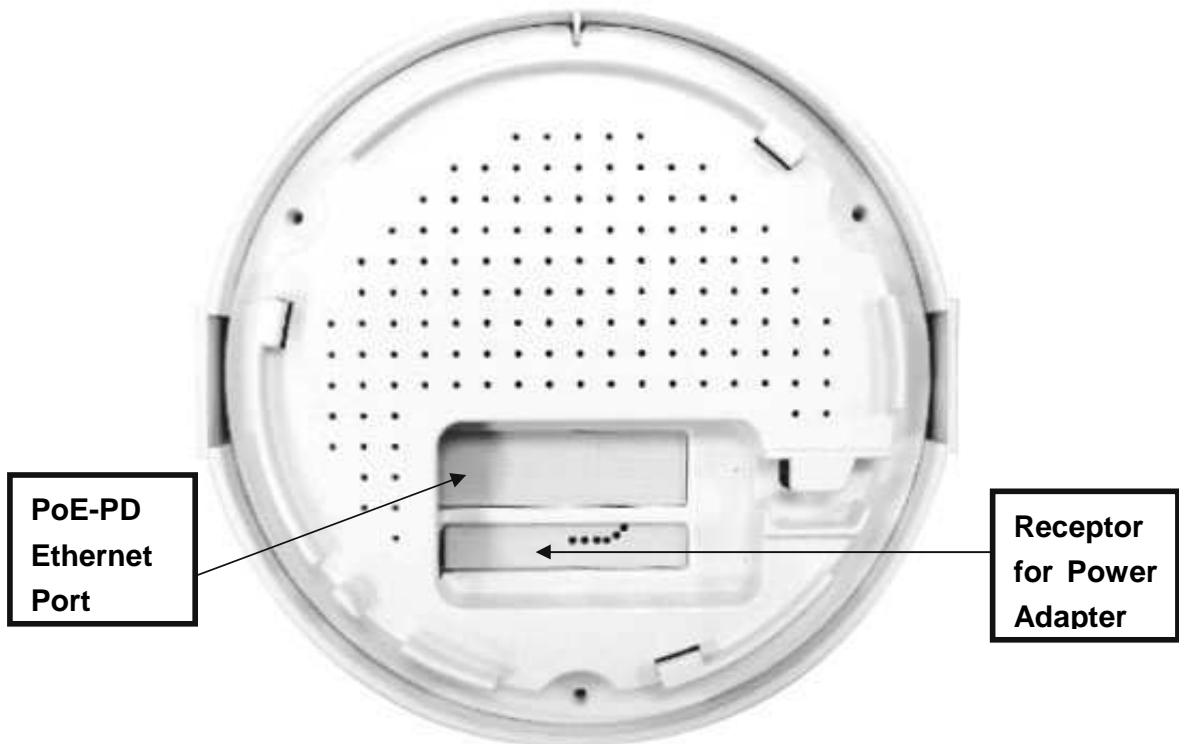

1.2.4 Mounting on the Ceiling / Wall

This device is designed for easily mounted on the ceiling or wall with a simple mount bracket. Before mounting it to the expected location, please make proper configuration for the device setting and run the PoE Ethernet cable to the location in advance.

The following illustrations show you how to mount this device on the ceiling / wall.

	Description	Illustration
A	Drill 2 holes for wall plugs. Self-tapping screws (Diameter : 3mm) If you run the cable above the ceiling (invisible cabling), you have to drill another big hole (about 10~20 mm diameter) to pull out the cable for connecting to the device.	
B	Screw the mounting bracket on the ceiling / wall.	

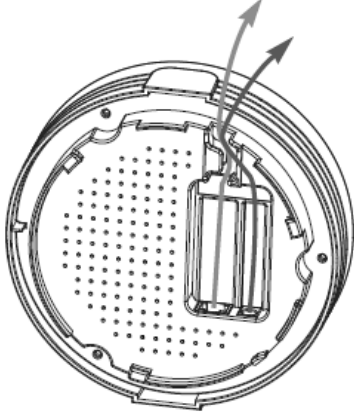
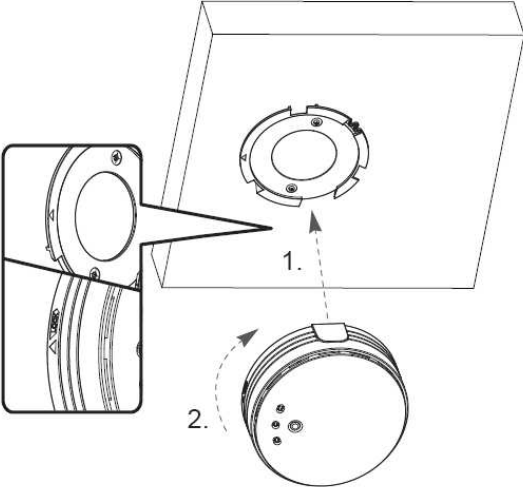
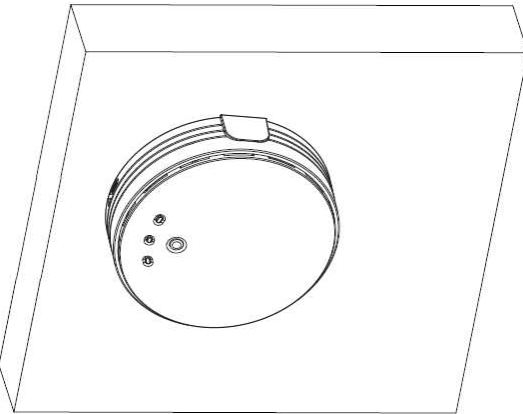
C	<p>Plug-in the cable (Ethernet cable, Power cord) to the connectors in the button side. Run the cables upward to proper location.</p>	
D	<p>Attached this device to mounting bracket by rotating it clock wisely to click into place.</p>	
E	<p>Installation completed.</p>	

1.2.5 LED Indicators



LED	Description
Status	When the device is booted up and ready: When WEC/Reset is triggered (with button pressed): Status LED flashes at different rate according button-pressed duration. Stage 1 (1 ~ 5 sec) : Flash very fast Stage 2 (6 ~ 10 sec) : Flash twice per second Stage 3 (11~15 sec) : Flash once per second Stage 4 (16~30 sec) : Solid Green OFF: The device is powered off.
WiFi	Green LED : Device is in Master Mode Amber LED: Device is in Slave Mode LED flash: data packet transferred. LED in fast flash per second during 2min: WPS PBC status OFF: Wireless Radio is disabled. LED in slow flash or Flash Green and Amber Alternately : Wireless Connection doesn't establish. LED in Solid: Wireless Connection established successfully.
LAN	OFF: No Ethernet connection.

	<p>Solid Green: Ethernet connection is linked up.</p>
--	---

	<p>Flash Green: Data packet is transferred over the Ethernet link.</p>
--	--

1.2.6 Button Definition

There is one multi-function push button “WEC/Reset” in this device. According to different button pressed duration, the device will take specific reaction. For ease of interacting with the device, you can also check the Status and WiFi LED to determine when to release the button. The Reset/WEC button’s behavior is defined below:

Function	Button	Description
Easy Configuration (Master to Slave)	WEC/Reset (Press 3 sec)	<p>There are two alternative AP modes defined for the device to operate with WEC (Wireless Easy Connection) feature. One is Master Mode (by default), and the other is Slave Mode.</p> <p>Please manually configure the Wireless Setting for the Master AP through web UI first, and also prepare a Slave AP that already been set to Slave Mode.</p> <p>Press the WEC/Reset button of the Master AP for 1~3 seconds, release it to trigger the WEC process. Then, WiFi Green LED flashes fast.</p> <p>Press the WEC/Reset button of the Slave AP for 1~3 seconds, release it to trigger the WEC process. Then, WiFi Amber LED flashes fast.</p> <p>Note: The Slave AP must be an un-configured one, if it has already been paired and configured before, please reset its Slave configuration first.</p> <p>After a few seconds (normally about 30~60 seconds). The Master and Slave APs can be paired automatically, and auto-duplicates the VAP1 wireless setting of the Master AP as that of the Slave AP.</p> <p>(If there is something wrong during paring the two devices, the process will be finished in 2 minutes.)</p> <p>Once the easy configuration process completed, the Status LED will be recovered to its original behavior (prior to you triggered it). And the WiFi LED will be Solid when Slave AP is connected to the network.</p>

Easy Configuration (Slave to Slave)	WEC/Reset (Press 3 sec)	<p>Besides the above “Master to Slave” configuration, the easy configuration process also supports “Slave to Slave” configuration.</p> <p>Press the WEC/Reset button of the first Slave AP (say Slave1 that has been paired and configured) for 1~3 seconds, release it to trigger the WEC process. Then, the WiFi LED flashes fast.</p> <p>Press the WEC/Reset button of the second Slave AP (say Slave2 that is an un-configured Slave AP) for 1~3 seconds, release it to trigger the WEC process. Then, the WiFi LED flashes fast.</p> <p>After a few seconds (normally about 30~60 seconds). The Slave1 and Slave2 APs can be paired automatically, and auto-duplicates the wireless setting of the Slave1 as that of the Slave2.</p> <p>(If there is something wrong during paring the two devices, the process will be finished in 2 minutes.)</p> <p>Once the easy configuration process completed, the Status LED will be recovered to its original behavior (prior to you triggered it).</p>
AP Mode Toggling	WEC/Reset (Press 8 sec)	<p>There are two alternative AP modes defined for the device to operate with WEC (Wireless Easy Connection) feature. One is Master Mode (by default), and the other is Slave Mode.</p> <p>To change the AP mode from one to the other, you have to:</p> <p>Press the WEC/Reset button for 6~10 seconds, and then release it.</p> <p>The WiFi LED becomes OFF in 3 ~ 5 seconds, After about 20 ~ 25 seconds, the WiFi LED will be lit ON again to indicate that the AP Mode is changed.</p> <p>It takes about 36 seconds to change (toggle) the AP Mode completely.</p> <p>WiFi Green LED : Device is in Master Mode WiFi Amber LED: Device is in Slave Mode</p>

Reset Slave AP Configuration	WEC/Reset (Press 13 sec)	<p>Press the WEC/Reset button for about 11~15 seconds and release it.</p> <p>The Slave AP will be marked as an un-configured device, so that it can be paired with another Master or configured Slave AP later.</p> <p>For Master AP, there is no effect on this button behavior.</p>
Reset to Default	WEC/Reset (Press 20 sec)	<p>Press the Reset/WEC button for about 20 seconds till the Status LED becomes solid Green to indicate that the reset to default function is triggered. Release the button.</p> <p>Then, the device will reboot automatically and apply the factory default settings as well.</p> <p>It takes about 2 minutes to finish the reset to factory default operation.</p>

2. Getting Started

Before you can install this product to designated location and make it operate properly, you have to configure the device setting to fit in your network environment.

Hardware Preparation:

- a. Connect an Ethernet cable between this device and the computer that you will operate to set up the device.
- b. Power on the device via connecting the power adaptor DC Plug to the DC Jack of this device and plug in the power adaptor to an electrical outlet.

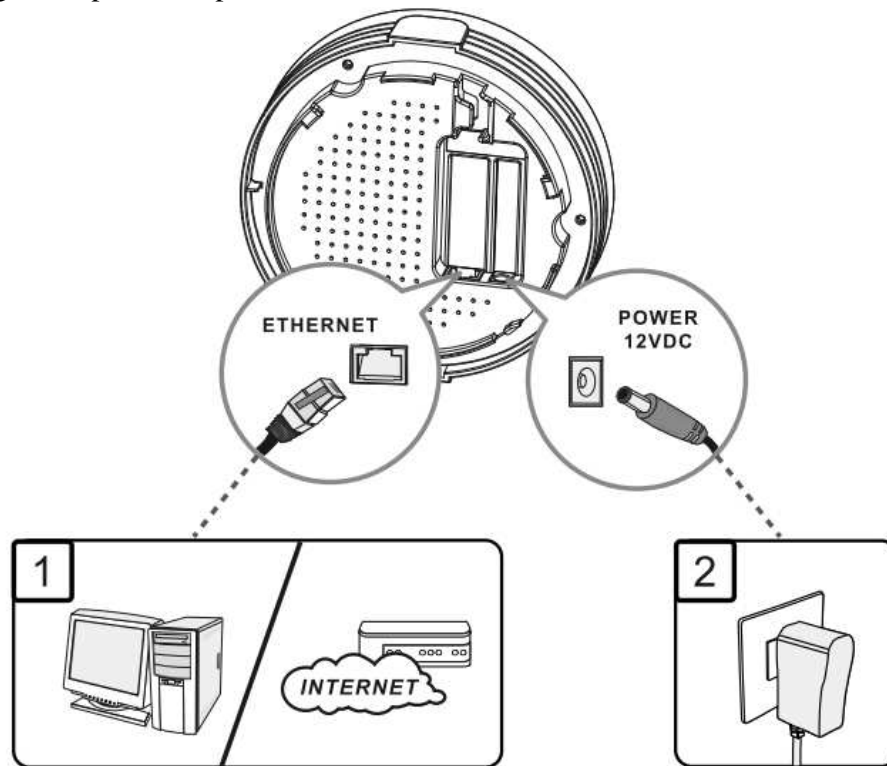

Software Preparation:

Most computers are connecting to a local network with dynamic IP (DHCP) setting. To access the web UI of the device, you have to change your computer's TCP/IPv4 settings into a static IP setting for the Ethernet Interface. You can refer to Appendix A for how to assign a Static IP address you your computer.

The device's default IP address is 192.168.123.50, and your computer must be assigned with a 192.168.123.x IP address to get access to the device.

Referring to Appendix A, and set the TCP/IPv4 address of your computer to 192.168.123.25, and subnet mask to 255.255.255.0.



After applying this setting, you can now access to the web UI for configuring the device.

2.1 Easy Setup via Web UI

You can browse web UI to configure the device. Firstly you need to launch the Setup Wizard browser first and then the Setup Wizard will guide you step-by-step to finish the basic setup process.

Activate the setup wizard:

Type in the IP Address (**http://192.168.123.50**)

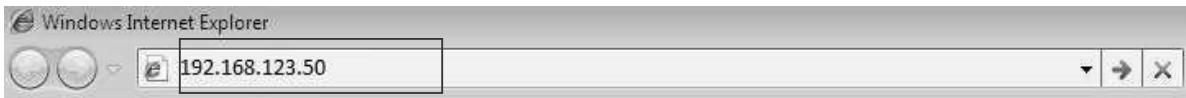

Type the default password “admin” in the system authentication fields, and then click ‘login’ button.

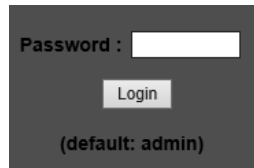

Select your language.



Select “**Wizard**” for basic settings in a simple way.

Or, you can go to **Basic Network / Advanced Network / Applications / System** to setup the configuration by your own selection.



Press “Next” to start the Setup Wizard.



Configure with the Setup Wizard

Step 1

You can change the password of administrator here.

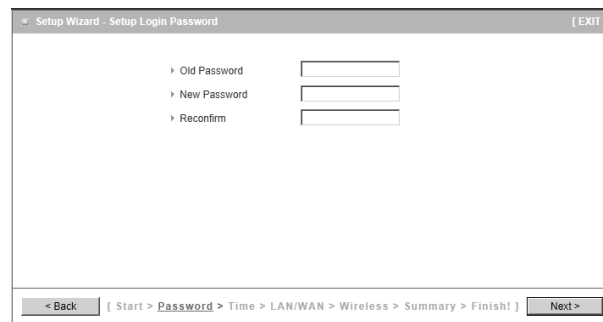

Step 2

LAN IP Address.

You have to change the IP address of this device according to your network configuration.



Step 3-1

Wireless settings.

You can specify the Wireless setting for VAP1.

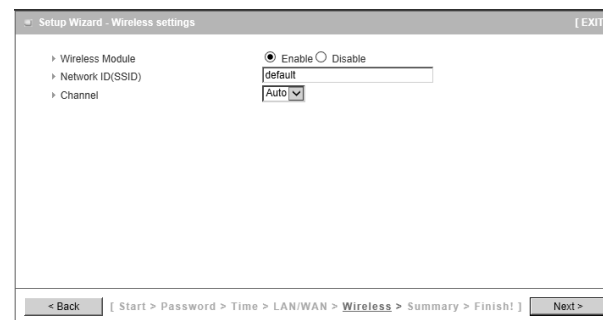

Step 3-2

Wireless settings.

Specify VAP1' s wireless authentication and encryption.

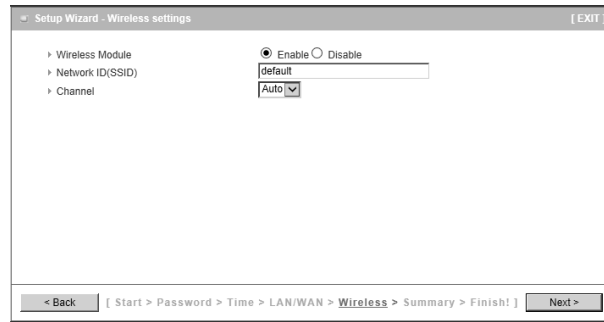

Step 4

Check the information again.

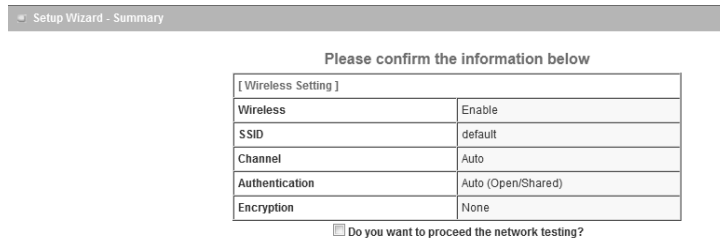

Step 5

System is applying the setting.

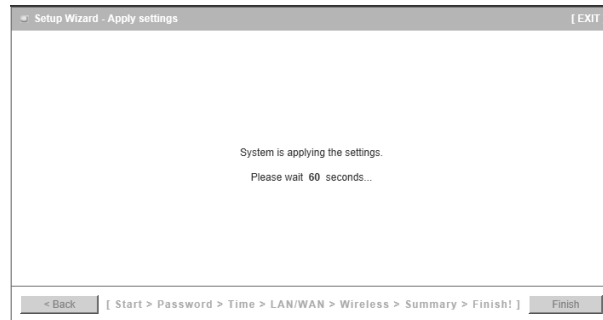

Step 6

Click finish to complete it.

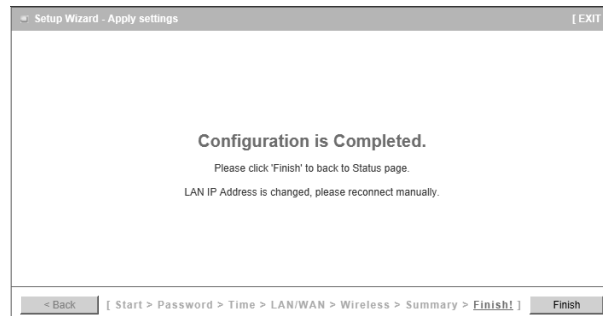

2.2 Use WEC Button to Setup Wireless Profiles

WEC (Wireless Easy Connection) is an easy configuration feature that is similar to well-known WPS function. It can be used to duplicate one device's wireless configuration to the other AP devices from the same manufacture by clicking one button for both devices.

There are two alternative AP modes defined for the device to operate with WEC (Wireless Easy Connection) feature. One is the Master Mode (by default), and the other is the Slave Mode. Before starting to use WEC to configure your AP devices, you have to learn how to identify and set the device in the Master Mode, or the Slave Mode (As stated in Section 1.2.4 and 1.2.5).

2.2.1 One Master and several isolated Slaves

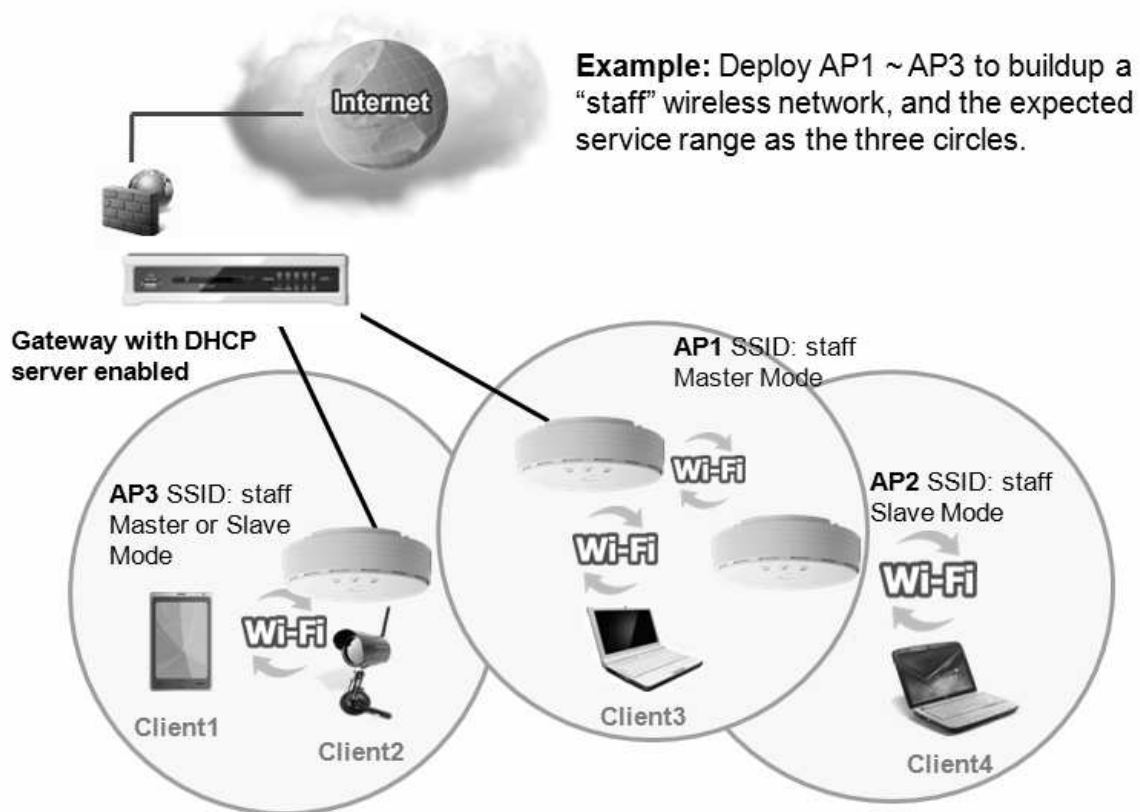

As illustrated in above figure, how to configure the three APs (AP1, AP2, AP3) to build up the “staff” wireless network? You can follow the procedure bellow:

Step	Button	Description
1	Set AP1 in Master Mode, and configure it via web UI.	<ol style="list-style-type: none"> 1. Make sure AP1 is in Master Mode (WiFi LED should be “Green” color, if not, you have to toggle its AP mode via pressing the WEC button for 9~10 seconds) 2. Login in to AP1 web UI and configure the wireless settings as what you want (LAN IP, SSID, encryption key, etc.).
2	Set AP2 and AP3 in Slave Mode.	<ol style="list-style-type: none"> 1. Make sure AP2 / AP3 is in Slave Mode (WiFi LED should be “Amber” color, if not, you have to toggle its AP mode via pressing the WEC button for 9~10 seconds)
3	Easy configure AP2 via WEC.	<p>Master to Slave WEC:</p> <ol style="list-style-type: none"> 1. Trigger AP1 into WEC configuration process via pressing the WEC button for 3 second. 2. Trigger AP2 into WEC configuration process via pressing the WEC button for 3 second. 3. It takes 30 ~ 60 seconds for the device to finish the WEC configuration process.
4	Easy configure AP3 via WEC.	<p>Master to Slave WEC:</p> <ol style="list-style-type: none"> 1. Trigger AP1 into WEC configuration process via pressing the WEC button for 3 second. 2. Trigger AP3 into WEC configuration process via pressing the WEC button for 3 second. 3. It takes 30 ~ 60 seconds for the device to finish the WEC configuration process.
5	Mount the devices AP1, AP2, and AP3 to expected locations.	<ol style="list-style-type: none"> 1. Install AP1 to its location first and verify its wireless network connectivity with a client device (Client3). 2. Install AP2 to its location and verify its wireless network connectivity with a client device (Client4) at the location beyond the service range of AP1. <p>Besides, You can also check the AP2’s WiFi LED, it should be “Solid Amber” if AP2 already connected a</p>

		<p>Master AP AP1.</p> <p>3. Install AP3 to its location and verify its wireless network connectivity with a client device (Client1) at the location beyond the service range of AP1.</p> <p>In this case, AP3 is located out of the service range of AP1, you don't have to check AP3's WiFi LED, but you have to connect the AP3 with an Ethernet cable to the gateway.</p>
--	--	--

2.2.2 One Master and a series of connected Slaves

This device also support universal repeater function, you can easily extend the wireless network with a series repeaters that are wireless concatenated to build up the wireless network without running Ethernet cables to each repeater.

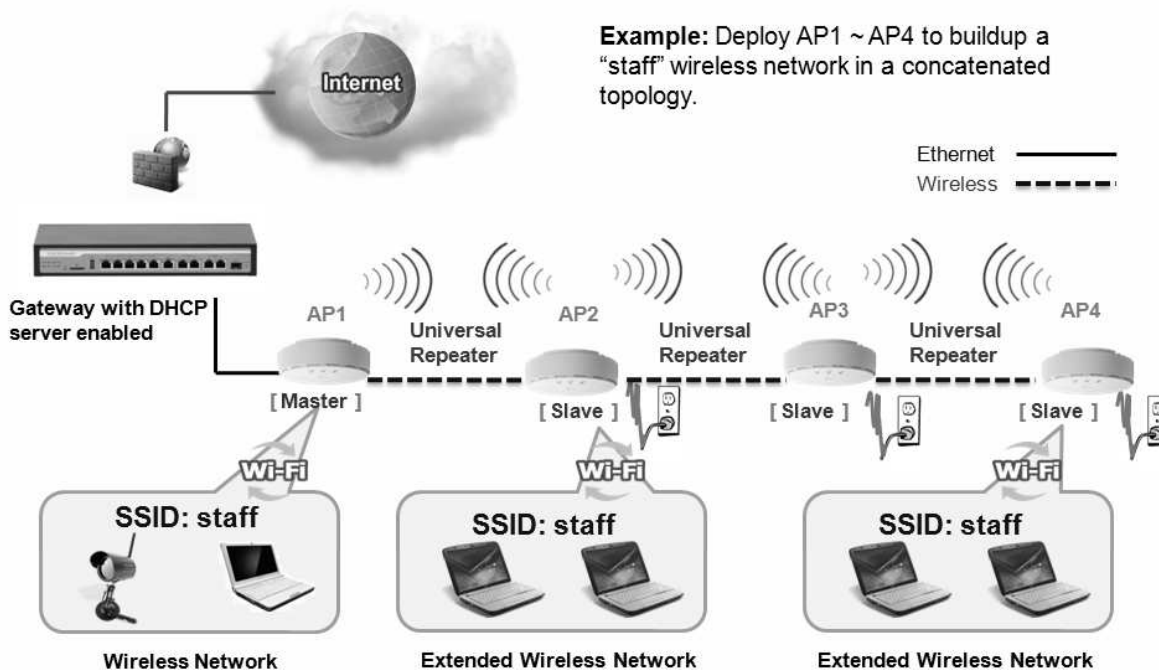

As illustrated in above figure, if you intend to deploy 4 APs (AP1 ~ AP4) to create a "Staff" wireless network, you can follow the procedure below:

Step	Button	Description
1	Set AP1 in Master Mode, and configure it via web UI.	Make sure AP1 is in Master Mode (WiFi LED should be “Green” color, if not, you have to toggle its AP mode via pressing the WEC button for 8 seconds) Login in to AP1 web UI and configure the wireless settings as what you want (LAN IP, SSID, encryption key, etc..).
2	Set AP2, AP3, AP4 in Slave Mode.	Make sure AP2 / AP3 / AP4 is in Slave Mode (WiFi LED should be “Amber” color, if not, you have to toggle its AP mode via pressing the WEC button for 8 seconds)
3	Easy configure AP2 via WEC.	Master to Slave WEC: Trigger AP1 into WEC configuration process via pressing the WEC button for 3 second. Trigger AP2 into WEC configuration process via pressing the WEC button for 3 second. It takes 30 ~ 60 seconds for the device to finish the WEC configuration process.
4	Easy configure AP3 via WEC.	Slave to Slave WEC: Trigger AP2 into WEC configuration process via pressing the WEC button for 3 second. Trigger AP3 into WEC configuration process via pressing the WEC button for 3 second. It takes 30 ~ 60 seconds for the device to finish the WEC configuration process.
5	Easy configure AP4 via WEC.	Slave to Slave WEC: Trigger AP3 into WEC configuration process via pressing the WEC button for 3 second. Trigger AP4 into WEC configuration process via pressing the WEC button for 3 second. It takes 30 ~ 60 seconds for the device to finish the WEC configuration process.
6	Mount the devices AP1, AP2, AP3, and AP4 to	Install AP1 to its location first and verify its wireless network connectivity with a client device.

	expected locations.	<p>Install AP2 to its location and verify its wireless network connectivity with a client device at the location beyond the service range of AP1.</p> <p>Besides, You can also check the AP2' s WiFi LED, it should be "Solid Amber" if AP2 already connected a Master AP AP1.</p> <p>Install AP3 to its location and verify its wireless network connectivity with a client device at the location beyond the service range of AP2.</p> <p>Besides, You can also check the AP3' s WiFi LED, it should be "Solid Amber" if AP3 already connected AP2.</p> <p>Install AP4 to its location and verify its wireless network connectivity with a client device at the location beyond the service range of AP3.</p> <p>Besides, You can also check the AP4' s WiFi LED, it should be "Solid Amber" if AP4 already connected AP3.</p>
--	---------------------	--

Although such wireless repeater function is available, there are limitations for such topology.

First, the available bandwidth for AP2 ~ AP4 will be decayed due to it is connected to it peer AP wirelessly. It depends on the data rate and environment. Besides, if one of the AP, say AP2, is disconnected, the APs behind it will be disconnected as well. Such topology needs more maintenance effort to keep the whole wireless network connectivity.

If Ethernet cable is reachable, connecting each AP to an Ethernet Uplink is recommended. Above WEC configuration process is also suitable for running Ethernet cables to AP2 ~ AP4 to get a better wireless network..

3 Making Configurations

Whenever you want to configure your network or this device, you can access the Configuration Menu by opening the web-browser and typing in the IP Address of the device. The default IP Address is: 192.168.123.50. In the configuration section you may want to check the connection status of this device, to do Basic or Advanced Network setup or to check the system status. These task buttons can be easily found in the cover page of the UI (User Interface).



Enter the default username and password “**admin**” in the System Password and then click ‘**login**’ button.

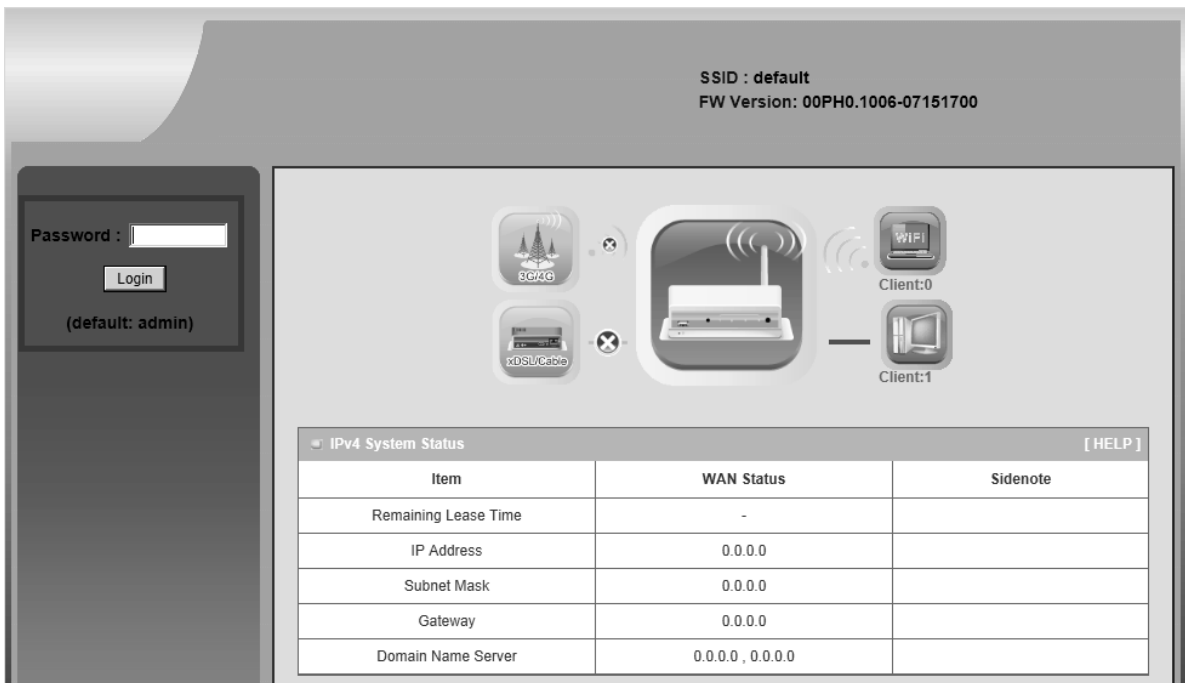

SSID : default
FW Version: 00PH0.1006-07151700

Password :
Login
(default: admin)

3G/4G
xDSL/Cable
WiFi
Client:0
Client:1

IPv4 System Status [HELP]		
Item	WAN Status	Sidenote
Remaining Lease Time	-	
IP Address	0.0.0.0	
Subnet Mask	0.0.0.0	
Gateway	0.0.0.0	
Domain Name Server	0.0.0.0 , 0.0.0.0	

Afterwards, you can go Wizard, Basic Network, Advanced Network, Application or System respectively on left hand side of web page.

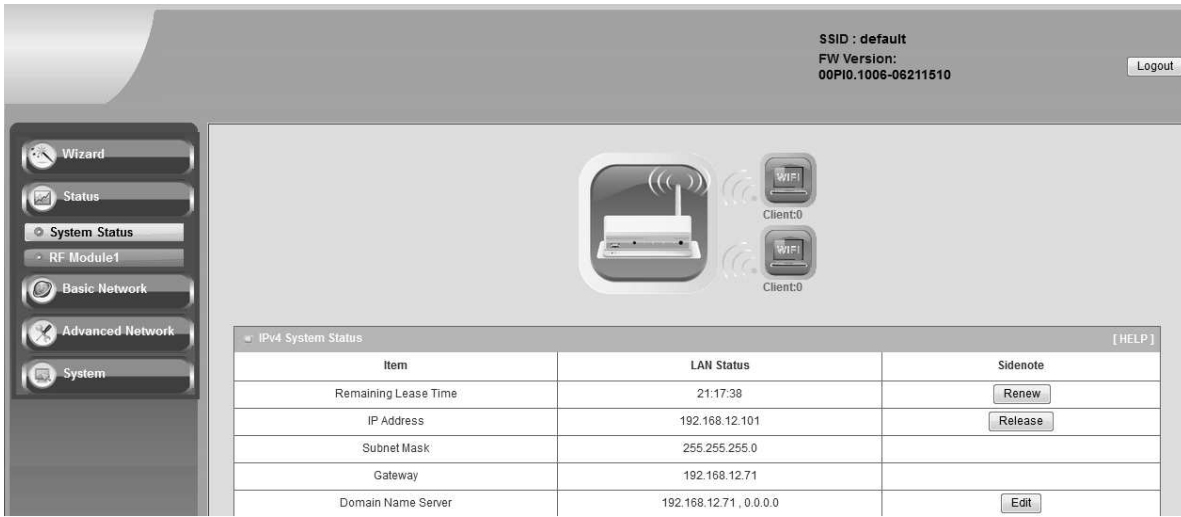

Note: You can see the Connection Status screen below after you logged in.

Wireless Status AP 1		
Item	WLAN Status	Sidenote
Wireless mode	Enable	(B/G/N Mixed)
SSID	default	<input type="button" value="Edit"/>
Channel	Auto	
Security	Auto	(None)
MAC address	00:50:18:00:07:F0	

Wireless Status AP 2		
Item	WLAN Status	Sidenote
Wireless mode	Enable	(B/G/N Mixed)
SSID	default	<input type="button" value="Edit"/>
Channel	Auto	
Security	Open	(None)
MAC address	00:50:18:00:06:F0	

Note : You can see all the status of this device in the 'Status' main menu section.

3.1 Basic Network

You can enter Basic Network for Ethernet LAN, Wireless and IPv6 settings in this web page.

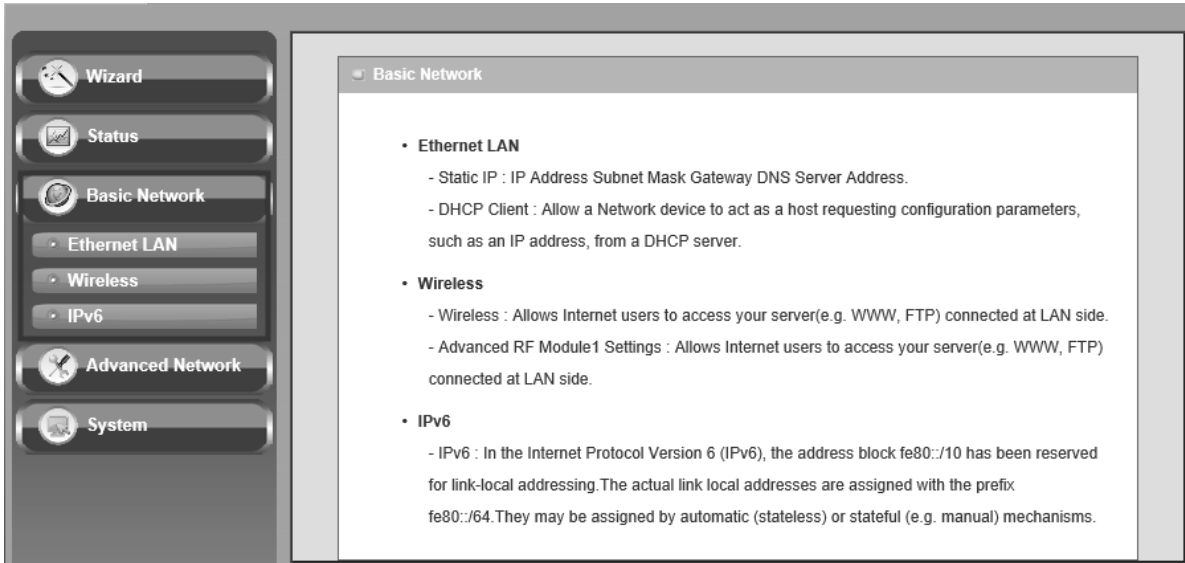

3.1.1 Ethernet LAN

The screenshot shows the 'Ethernet LAN' configuration page. The main content area is titled 'Ethernet LAN' and contains a section for 'Device Network Type' with the following table:

Item	Setting
▶ Device Network Type	<input checked="" type="radio"/> Static <input type="radio"/> DHCP
▶ LAN IP Address	<input type="text" value="192.168.123.50"/>
▶ Subnet Mask	<input type="text" value="255.255.255.0"/> ▼
▶ Gateway	<input type="text"/>
▶ Primary DNS	<input type="text"/>
▶ Secondary DNS	<input type="text"/>

At the bottom of the configuration area are 'Save' and 'Undo' buttons.

1. Device Network Type: This device supports two network types for connecting to your local network.

Static IP: Allow a device to act as a Static host. If you need Static host and please entry IP Address.

DHCP: Allow a device to act as a host requesting configuration parameters, such as an IP address from a DHCP server.

Note: Please check if there is DHCP server in your Network, first.

2. LAN IP Address, Subnet Mask, Gateway, Primary / Secondary DNS: If you selected the Static IP network type for this device, you have to further specify the LAN IP Address, Subnet mask, Gateway, and optional Primary / Secondary DNS settings for well connecting to your local network.

3.1.2 Wireless

Wireless settings allow you to set the WLAN (wireless LAN) configuration items. When the wireless configuration is done, your wireless network is ready for supporting your local WiFi devices such as your laptop PC, wireless printer and some portable devices.

The screenshot shows a web interface for configuring wireless settings. On the left is a navigation menu with options: Wizard, Status, Basic Network (Ethernet LAN, **Wireless**, IPv6), Advanced Network, and System. The main content area is titled 'Advanced RF Module1 Settings' and contains a 'Wireless Setting' table. At the bottom of the table are buttons for 'Save', 'Undo', 'WPS Setup...', and 'Wireless Client List...'.

Item	Setting
Wireless Module	<input checked="" type="checkbox"/> Enable
Wireless Operation Mode	WDS Hybrid Mode
Lazy Mode	<input checked="" type="checkbox"/> Enable
Green AP	<input type="checkbox"/> Enable
AP Number	AP 1 <input checked="" type="checkbox"/> Enable
Network ID(SSID)	default
SSID Broadcast	<input checked="" type="checkbox"/> Enable
VLAN ID	<input type="checkbox"/> Enable 3 (3~4094)
Max Supported Stations	<input type="checkbox"/> Enable (1~16)
Channel	Auto
Wireless Mode	B/G/N mixed
Bandwidth	Auto
Authentication	Open
802.1X	<input type="checkbox"/> Enable
Encryption	None

The embedded RF Module/Wireless is a IEEE 802.11b/g/n compliant 2.4GHz Wireless Module.

3.1.2.1 Wireless Setup

There are several wireless operation modes provided by this device. They are: “AP Only Mode”, “WDS Hybrid Mode”, “WDS Only Mode”, and “Universal Repeater Mode”. You can choose the expected mode and configure the device manually.

Besides manually configuration the devices to be deployed one by one, you can also configure your devices via the simple WEC configuration approach as stated in last Chapter. By default, the Master AP is set to the WDS-hybrid Mode, and the Slave APs are set to the Universal Repeater mode. You just have to manually configure the Master AP via the web UI configuration, and use the WEC process for the rest Slave APs.

3.1.2.1.1 AP Only Mode

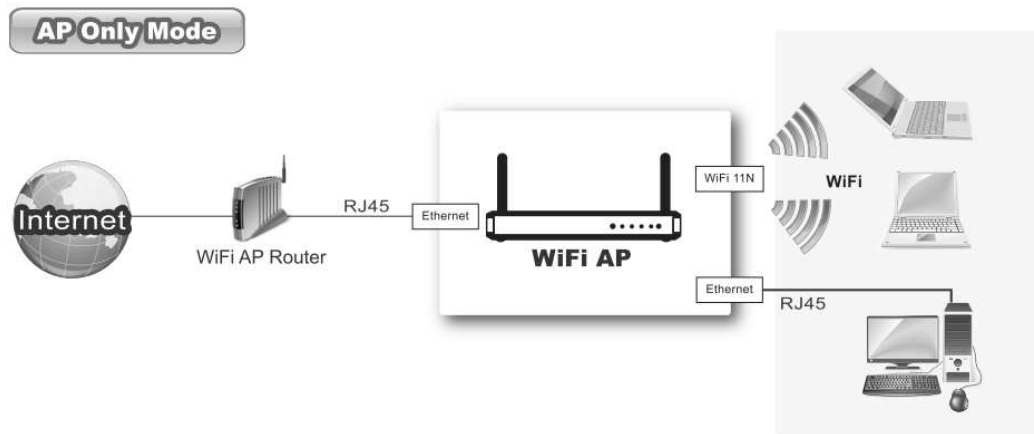

When acting as an access point, this device connects all the wireless stations to a wired network.

RF Module1
Advanced RF Module1 Settings

Wireless Setting
[HELP]

Item	Setting
Wireless Module	<input checked="" type="checkbox"/> Enable
Wireless Operation Mode	AP Only Mode ▼
Green AP	<input type="checkbox"/> Enable
AP Number	AP 1 ▼ <input checked="" type="checkbox"/> Enable
Network ID(SSID)	default
SSID Broadcast	<input checked="" type="checkbox"/> Enable
VLAN ID	<input type="checkbox"/> Enable 3 (3~4094)
Max Supported Stations	<input type="checkbox"/> Enable (1~16)
Channel	Auto ▼
Wireless Mode	B/G/N mixed ▼
Bandwidth	Auto ▼
Authentication	Open ▼
802.1X	<input type="checkbox"/> Enable
Encryption	None ▼

1. **Wireless Module:** Enable the wireless function.
2. **Wireless Operation Mode:** Choose “AP Only Mode” from the list.
3. **Green AP:** Enable the Green AP function to reduce the power consumption when there is no wireless traffic.
4. **AP Number:** This device supports up to 8 SSIDs at the same time for you to manage your wireless networks. You can select AP1 ~ AP8 and configure each wireless network individually.
5. **Network ID (SSID):** Network ID is used for identifying a Wireless LAN. Client stations can roam freely over this device and other Access Points that have the same Network ID. The factory default SSID is “default”, you can change it to a meaningful identifier for the wireless users to easy find it out.
6. **SSID Broadcast:** By default, the SSID Broadcast setting is “Enable”, and the device will broadcast beacons that have some information, including SSID, to the air, so that wireless clients can know how many AP devices by scanning the network. Therefore, if this setting is configured as “Disable”, you can hide the wireless network from been

scanned by wireless clients. Those who know the SSID can manually specify the SSID on their client device to connect the hidden wireless network.

7. **VLAN ID:** This device supports mapping of a SSID to a certain VLAN ID to separate workgroups across wireless and wired domains. By default, it is not enabled. If you enabled this function, you have to specify a VLAN ID for the wireless network.
8. **Max Supported Stations:** You can specify the number of maximum stations that can associate to the SSID simultaneously.
9. **Channel:** The radio channel number. The permissible channels depend on the Regulatory Domain. The factory default setting is auto channel selection. It's recommended to choose a channel that is not used in your environment to reduce radio interference
10. **Wireless Mode:** The RF1 module supports 802.11b/g/n modes. You can also choose "N only", "G/N mixed" or "B/G/N mixed". The factory default setting is "B/G/N mixed".
11. **Bandwidth:** The default setting for Bandwidth is "Auto". You can change it to "20MHz" with care if some clients are suffering from the connectivity problem in higher bandwidth setting.
12. **Authentication & Encryption:** You may select one of the following authentications to secure your wireless network: Open (include 802.1x), Shared, Auto, WPA-PSK, WPA, WPA2-PSK, WPA2, WPA-PSK/WPA2-PSK, or WPA /WPA2.

- **Open**

Open system authentication simply consists of two communications. The first is an authentication request by the client that contains the station ID (typically the MAC address). This is followed by an authentication response from the AP containing a success or failure message. An example of when a failure may occur is if the client's MAC address is explicitly excluded in the AP's configuration.

In this mode you can also enable the 802.1x feature if you have another RADIUS server for user authentication. You need to input IP address, port, shared key of RADIUS server here.

▶ 802.1X	<input checked="" type="checkbox"/> Enable
▶ RADIUS Server IP	0.0.0.0
▶ RADIUS port	1812
▶ RADIUS Shared Key	

In this mode, you can only choose “None” or “WEP” in the encryption field.

- **Shared**

Shared key authentication relies on the fact that both stations taking part in the authentication process have the same "shared" key or passphrase. The shared key is manually set on both the client station and the AP. Three types of shared key authentication are available today for home or small office WLAN environments.

- **Auto**

The gateway will select appropriate authentication method (Open or Shared) according to the WiFi client's request automatically.

- **WPA-PSK**

Select Encryption mode and enter the Pre-share Key. You can fill in 64 hexadecimal (0, 1, 2...8, 9, A, B...F) digits, or 8 to 63 ASCII characters as the pre-share key.

- **WPA**

Select Encryption mode and enter RADIUS Server related information. You have to specify the IP address, and port number for the RADIUS Server, and then fill in 64 hexadecimal (0, 1, 2...8, 9, A, B...F) digits, or 8 to 63 ASCII characters as the shared key. The key value is shared by the RADIUS server and this router. This key value must be consistent with the key value in the RADIUS server. The available encryption modes are “TKIP”, “AES”, or “TKIP/AES”.

- **WPA2-PSK**

Select Encryption mode and enter the Pre-share Key. You can fill in 64 hexadecimal (0, 1, 2...8, 9, A, B...F) digits, or 8 to 63 ASCII characters as the pre-share key.

- **WPA2**

Select Encryption mode and enter RADIUS Server related information. You have to specify the IP address, and port number for the RADIUS Server, and then fill in 64 hexadecimal (0, 1, 2...8, 9, A, B...F) digits, or 8 to 63 ASCII characters as the shared key. The key value is shared by the RADIUS server and this router. This key value must be consistent with the key value in the RADIUS server. The available encryption modes are “TKIP”, “AES”, or “TKIP/AES”.

- **WPA-PSK/WPA2-PSK**

Select Encryption mode and enter the Pre-share Key. You can fill in 64 hexadecimal (0, 1, 2...8, 9, A, B...F) digits, or 8 to 63 ASCII characters as the pre-share key.

- **WPA/WPA2**

If some of wireless clients can only support WPA, but most of them can support WPA2. You can choose this option to support both of them. Select Encryption mode and enter RADIUS Server related information. You have to specify the IP address,

and port number for the RADIUS Server, and then fill in 64 hexadecimal (0, 1, 2...8, 9, A, B...F) digits, or 8 to 63 ASCII characters as the shared key. The key value is shared by the RADIUS server and this router. This key value must be consistent with the key value in the RADIUS server.

Afterwards, click on **“Save”** to store your settings or click **“Undo”** to give up the changes.

3.1.2.1.2 WDS Hybrid Mode

This mode makes device act as a wireless bridge but also have AP function. While acting as a wireless Bridge, Wireless Router 1 and Wireless Router 2 can communicate with each other through wireless interface (with WDS). Thus All Stations can communicate each other and are able to access Internet if Wireless Router 1 has the Internet connection.

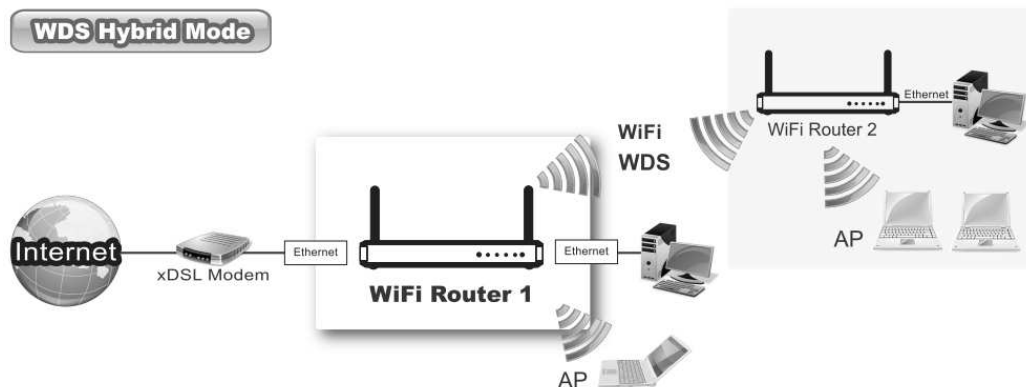

RF Module1
Advanced RF Module1 Settings

Wireless Setting
[HELP]

Item	Setting
Wireless Module	<input checked="" type="checkbox"/> Enable
Wireless Operation Mode	WDS Hybrid Mode ▼
Lazy Mode	<input checked="" type="checkbox"/> Enable
Green AP	<input type="checkbox"/> Enable
AP Number	AP 1 ▼ <input checked="" type="checkbox"/> Enable
Network ID(SSID)	default
SSID Broadcast	<input checked="" type="checkbox"/> Enable
VLAN ID	<input type="checkbox"/> Enable <input type="text" value="3"/> (3~4094)
Max Supported Stations	<input type="checkbox"/> Enable <input type="text" value=""/> (1~16)
Channel	Auto ▼
Wireless Mode	B/G/N mixed ▼
Bandwidth	Auto ▼
Authentication	Open ▼
802.1X	<input type="checkbox"/> Enable
Encryption	None ▼

1. **Lazy Mode:** This device support the Lazy Mode to automatically learn the MAC address of WDS peers, you don't have to input other peer AP's MAC address. However, not all the APs can be set to enable the Lazy mode simultaneously; at least there must be one AP with all the WDS peers' MAC address filled.
2. **Green AP:** Enable the Green AP function to reduce the power consumption when there is no wireless traffic.
3. **AP Number:** This device supports up to 8 SSIDs at the same time for you to manage your wireless networks. You can select AP1 ~ AP8 and configure each wireless network individually.
4. **Network ID (SSID):** Network ID is used for identifying a Wireless LAN. Client stations can roam freely over this device and other Access Points that have the same Network ID. The factory default SSID is "default", you can change it to a meaningful identifier for the wireless users to easy find it out.
5. **SSID Broadcast:** By default, the SSID Broadcast setting is "Enable", and the device will broadcast beacons that have some information, including SSID, to the air, so that wireless

- clients can know how many AP devices by scanning the network. Therefore, if this setting is configured as “Disable”, you can hide the wireless network from been scanned by wireless clients. Those who know the SSID can manually specify the SSID on their client device to connect the hidden wireless network.
6. **VLAN ID:** This device supports mapping of a SSID to a certain VLAN ID to separate workgroups across wireless and wired domains. By default, it is not enables. If you enabled this function, you have to specify a VLAN ID for the wireless network.
 7. **Max Supported Stations:** You can specify the number of maximum stations that can associate to the SSID simultaneously.
 8. **Channel:** The radio channel number. The permissible channels depend on the Regulatory Domain. The factory default setting is auto channel selection. It’s recommended to choose a channel that is not used in your environment to reduce radio interference
 9. **Wireless Mode:** The RF1 module supports 802.11b/g/n modes. You can also choose “N only”, “G/N mixed” or “B/G/N mixed”. The factory default setting is “B/G/N mixed”.
 10. **Bandwidth:** The default setting for Bandwidth is “Auto”. You can change it to “20MHz” with care if some clients are suffering from the connectivity problem in higher bandwidth setting.
 11. **Authentication & Encryption:** You may select one of the following authentications to secure your wireless network: Open (include 802.1x), Shared, Auto, WPA-PSK, and WPA2-PSK.

- **Open**

Open system authentication simply consists of two communications. The first is an authentication request by the client that contains the station ID (typically the MAC address). This is followed by an authentication response from the AP containing a success or failure message. An example of when a failure may occur is if the client's MAC address is explicitly excluded in the AP’s configuration.

In this mode you can also enable the 802.1x feature if you have another RADIUS server for user authentication. You need to input IP address, port, shared key of RADIUS server here.

▶ 802.1X	<input checked="" type="checkbox"/> Enable
▶ RADIUS Server IP	0.0.0.0
▶ RADIUS port	1812
▶ RADIUS Shared Key	

In this mode, you can only choose “None” or “WEP” in the encryption field.

- **Shared**

Shared key authentication relies on the fact that both stations taking part in the authentication process have the same "shared" key or passphrase. The shared key is manually set on both the client station and the AP. Three types of shared key authentication are available today for home or small office WLAN environments.

- **Auto**

The gateway will select appropriate authentication method (Open or Shared) according to the WiFi client's request automatically.

- **WPA-PSK**

Select Encryption mode and enter the Pre-share Key. You can fill in 64 hexadecimal (0, 1, 2...8, 9, A, B...F) digits, or 8 to 63 ASCII characters as the pre-share key.

- **WPA2-PSK**

Select Encryption mode and enter the Pre-share Key. You can fill in 64 hexadecimal (0, 1, 2...8, 9, A, B...F) digits, or 8 to 63 ASCII characters as the pre-share key.

12. **Remote AP MAC 1 ~ Remote AP MAC 4:** If you do not enable the Lazy mode, you have to enter the wireless MAC address for each WDS peer one by one.

Afterwards, click on “Save” to store your settings or click “Undo” to give up the changes.

3.1.2.1.3 WDS Only Mode

WDS (Wireless Distributed System) function let APs acts as a wireless LAN bridge. All stations associated with WDS APs could see each other and roam through APs without changing WiFi configurations. You can use this feature to build up a large wireless network in a large space like airports, hotels and schools etc.

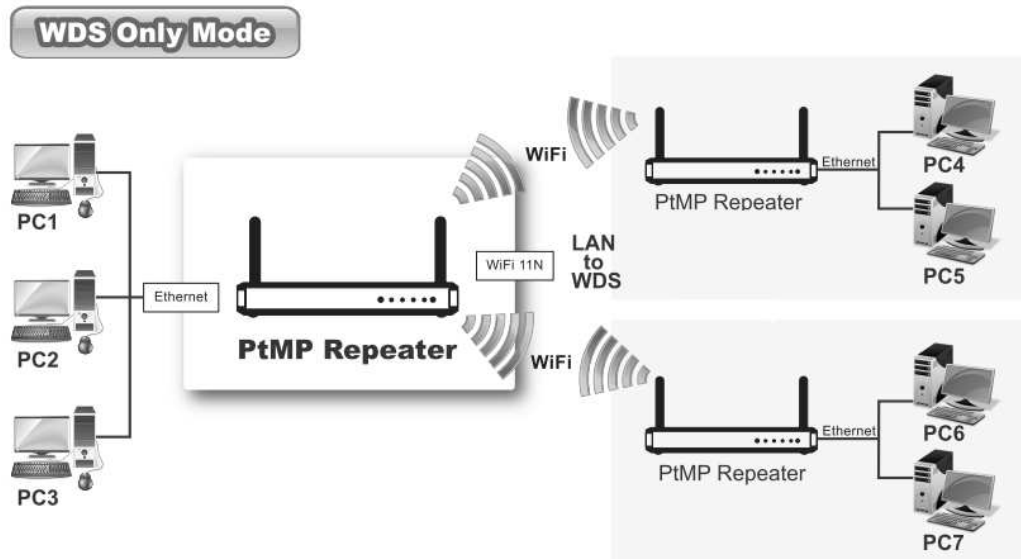

RF Module1 > Advanced RF Module1 Settings	
Wireless Setting [HELP]	
Item	Setting
Wireless Module	<input checked="" type="checkbox"/> Enable
Wireless Operation Mode	WDS Only Mode ▾
Green AP	<input type="checkbox"/> Enable
Channel	Auto ▾
Authentication	Open ▾
Encryption	None ▾
Scan Remote AP's MAC List	Scan
Remote AP MAC 1	<input type="text"/>
Remote AP MAC 2	<input type="text"/>
Remote AP MAC 3	<input type="text"/>
Remote AP MAC 4	<input type="text"/>
<input type="button" value="Save"/> <input type="button" value="Undo"/>	

1. **Lazy Mode:** This device support the Lazy Mode to automatically learn the MAC address of WDS peers, you don't have to input other peer AP's MAC address. However, not all the APs can be set to enable the Lazy mode simultaneously; at least there must be one AP with all the WDS peers' MAC address filled.
2. **Green AP:** Enable the Green AP function to reduce the power consumption when there is no wireless traffic.
3. **Channel:** The radio channel number. The permissible channels depend on the Regulatory Domain. The factory default setting is auto channel selection. It's recommended to choose a channel that is not used in your environment to reduce radio interference
4. **Wireless Mode:** The RF1 module supports 802.11b/g/n modes. You can also choose "N only", "G/N mixed" or "B/G/N mixed". The factory default setting is "B/G/N mixed".
5. **Bandwidth:** The default setting for Bandwidth is "Auto". You can change it to "20MHz" with care if some clients are suffering from the connectivity problem in higher bandwidth setting.
6. **Authentication & Encryption:** You may select one of the following authentications to secure your wireless network: Open (include 802.1x), Shared, Auto, WPA-PSK, and WPA2-PSK.
 - **Open**

Open system authentication simply consists of two communications. The first is an

authentication request by the client that contains the station ID (typically the MAC address). This is followed by an authentication response from the AP containing a success or failure message. An example of when a failure may occur is if the client's MAC address is explicitly excluded in the AP's configuration.

In this mode you can also enable the 802.1x feature if you have another RADIUS server for user authentication. You need to input IP address, port, shared key of RADIUS server here.

▶ 802.1X	<input checked="" type="checkbox"/> Enable
▶ RADIUS Server IP	0.0.0.0
▶ RADIUS port	1812
▶ RADIUS Shared Key	

In this mode, you can only choose “None” or “WEP” in the encryption field.

- **Shared**

Shared key authentication relies on the fact that both stations taking part in the authentication process have the same "shared" key or passphrase. The shared key is manually set on both the client station and the AP. Three types of shared key authentication are available today for home or small office WLAN environments.

- **Auto**

The gateway will select appropriate authentication method (Open or Shared) according to the WiFi client's request automatically.

- **WPA-PSK**

Select Encryption mode and enter the Pre-share Key. You can fill in 64 hexadecimal (0, 1, 2...8, 9, A, B...F) digits, or 8 to 63 ASCII characters as the pre-share key.

- **WPA2-PSK**

Select Encryption mode and enter the Pre-share Key. You can fill in 64 hexadecimal (0, 1, 2...8, 9, A, B...F) digits, or 8 to 63 ASCII characters as the pre-share key.

7. **Remote AP MAC 1 ~ Remote AP MAC 4:** If you do not enable the Lazy mode, you have to enter the wireless MAC address for each WDS peer one by one.

Afterwards, click on “**Save**” to store your settings or click “**Undo**” to give up the changes.

3.1.2.1.4 Universal Repeater Mode

Universal Repeater is a technology used to extend wireless coverage. It provides the function to act as Adapter (Client) and AP at the same time and can use this function to connect to a Root AP and use AP (SSID name must be the same as that of Root AP) function to service all wireless stations within its coverage. All the stations within the coverage of this access point can be bridged to the Root AP.

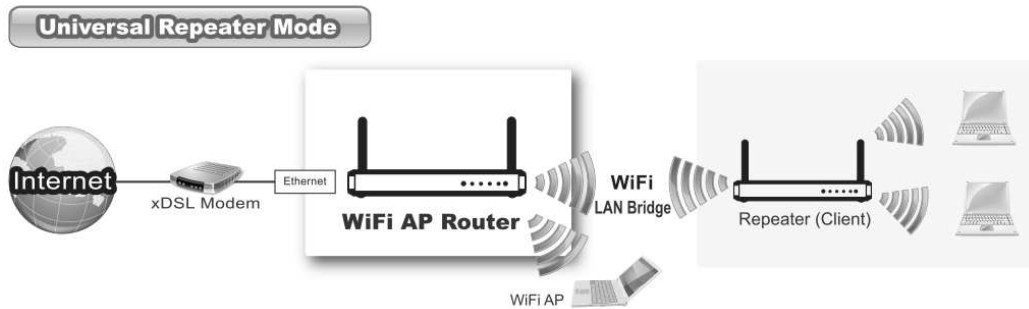

RF Module1
Advanced RF Module1 Settings

Wireless Setting
[HELP]

Item	Setting
Wireless Module	<input checked="" type="checkbox"/> Enable
Wireless Operation Mode	Universal Repeater
Green AP	<input type="checkbox"/> Enable
Network ID(SSID)	default
Destination AP MAC	
SSID Broadcast	<input checked="" type="checkbox"/> Enable
VLAN ID	<input type="checkbox"/> Enable 3 (3~4094)
Max Supported Stations	<input type="checkbox"/> Enable (1~16)
Channel	Auto
Bandwidth	Auto
Authentication	Open
Encryption	None

Save
Undo
WPS Setup...
Wireless Client List...
Scan

1. **Green AP:** Enable the Green AP function to reduce the power consumption when there is no wireless traffic.
2. **Network ID (SSID):** Network ID is used for identifying a Wireless LAN. Client stations can roam freely over this device and other Access Points that have the same Network ID. The factory default SSID is “default”, you have to change it to the same SSID of the peer AP to be associated under the Universal Repeater Mode.
3. **Destination AP MAC:** Besides to have the same SSID of the peer AP to be associated under the Universal Repeater mode, you also have to specify the MAC address of the peer AP to avoid making wrong connection with other AP that has the same SSID.
4. **SSID Broadcast:** By default, the SSID Broadcast setting is “Enable”, and the device will broadcast beacons that have some information, including SSID, to the air, so that wireless clients can know how many AP devices by scanning the network. Therefore, if this setting is configured as “Disable”, you can hide the wireless network from been scanned by wireless clients. Those who know the SSID can manually specify the SSID on their client device to connect the hidden wireless network.
5. **VLAN ID:** This device supports mapping of a SSID to a certain VLAN ID to separate the work groups across wireless and wired domains. By default, it is not enables. If you enabled this function, you have to specify a VLAN ID for the wireless network.
6. **Max Supported Stations:** You can specify the number of maximum stations that can associate to the SSID simultaneously.
7. **Channel:** The radio channel number. The permissible channels depend on the Regulatory Domain. The factory default setting is auto channel selection. It’s recommended to choose a channel that is not used in your environment to reduce radio interference
8. **Bandwidth:** The default setting for Bandwidth is “Auto”. You can change it to “20MHz” with care if some clients are suffering from the connectivity problem in higher bandwidth setting.
9. **Authentication & Encryption:** You may select one of the following authentications to secure your wireless network: Open, Shared, Auto, WPA-PSK, and WPA2-PSK.

Afterwards, click on “**Save**” to store your settings or click “**Undo**” to give up the changes.

3.1.3 Advanced Wireless Setup

This device provides advanced wireless setup for professional user to optimize the wireless performance under the specific installation environment.

3.1.3.1 Advanced RF Module1/Wireless Settings

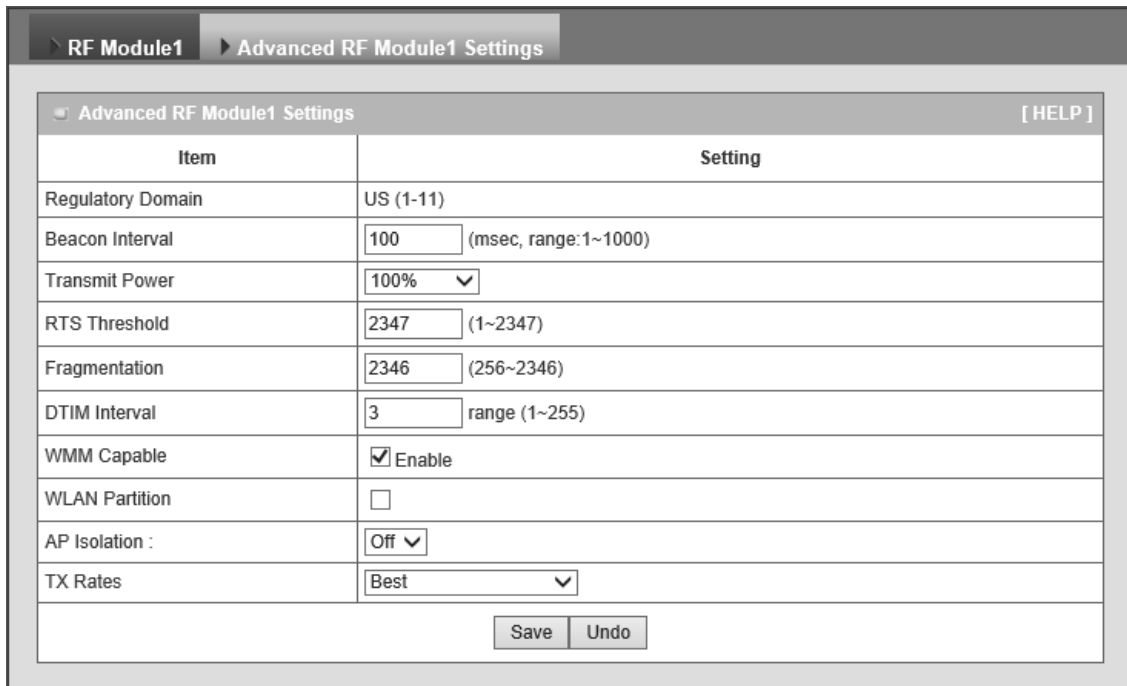

Item	Setting
Regulatory Domain	US (1-11)
Beacon Interval	100 (msec, range:1~1000)
Transmit Power	100%
RTS Threshold	2347 (1~2347)
Fragmentation	2346 (256~2346)
DTIM Interval	3 range (1~255)
WMM Capable	<input checked="" type="checkbox"/> Enable
WLAN Partition	<input type="checkbox"/>
AP Isolation :	Off
TX Rates	Best

- 1. Beacon interval:** Beacons are packets sent by a wireless router to synchronize wireless devices.
- 2. Transmit Power:** Normally the wireless transmission power operates at 100% out power specification of this device. You can lower down the power ratio to prevent transmissions from reaching beyond your corporate/home office or designated wireless area.
- 3. RTS Threshold:** If an excessive number of wireless packet collision occurred, the wireless performance will be affected. It can be improved by adjusting the RTS/CTS (Request to Send/Clear to Send) threshold value.
- 4. Fragmentation:** Wireless frames can be divided into smaller units (fragments) to improve performance in the presence of RF interference and at the limits of RF coverage.
- 5. DTIM interval:** A DTIM is a countdown informing clients of the next window for listening to broadcast and multicast messages. When the wireless router has buffered

broadcast or multicast messages for associated clients, it sends the next DTIM with a DTIM Interval value.

6. **WMM Capable:** WMM can help control latency and jitter when transmitting multimedia content over a wireless connection.
7. **WLAN Partition:** You can check the WLAN Partition function to separate the wireless clients associated to the same VAP. The wireless clients can't communicate each other, but they can access the internet and other Ethernet LAN devices
8. **AP Isolation:** If you enabled multiple VAPs in this device, you can further decide whether the wireless clients associated to different VAPs can access to each other or not. When you enabled the AP Isolation function, Each VAP is isolated to the others consequently.
9. **TX Rate:** For WiFi transmit rate, you can choose "Best" for auto-adjustment according to WiFi signal quality in your environment, or you can fix it in certain TX rate. Please note the WiFi connection may be dropped if you fix at a higher data rate but in a noisy (poor RF signal quality) environment.

Afterwards, click on "**Save**" to store your settings or click "**Undo**" to give up the changes.

3.1.4 IPv6

The growth of the Internet has created a need for more addresses than are possible with IPv4. **IPv6 (Internet Protocol version 6)** is a version of the Internet Protocol (IP) intended to succeed IPv4, which is the protocol currently used to direct almost all Internet traffic. IPv6 also implements additional features not present in IPv4. It simplifies aspects of address assignment (stateless address auto-configuration), network renumbering and router announcements when changing Internet connectivity providers.

This device supports IPv6, it works as a IPv6 bridge, you can use it to build a IPv6 network.

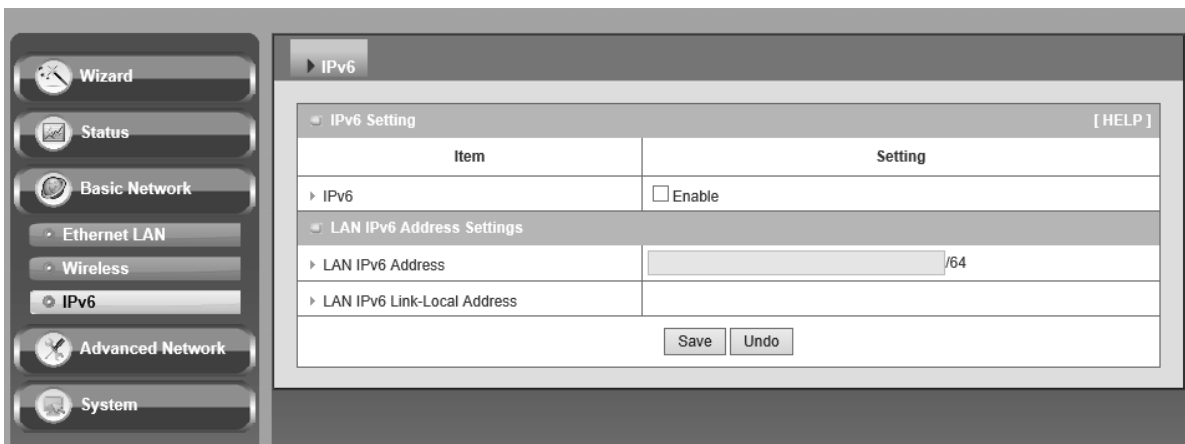

- 1. LAN IPv6 address settings:** Please enter “LAN IPv6 address” and ignore the “LAN IPv6 Link-Local address”.

“2001:0db8:85a3:0000:0000:8a2e:0370:7334”

3.2 Advanced Network

This device also supports other advanced network features for you to further manage the device. You can finish the configuration for Firewall, and Management in this section.

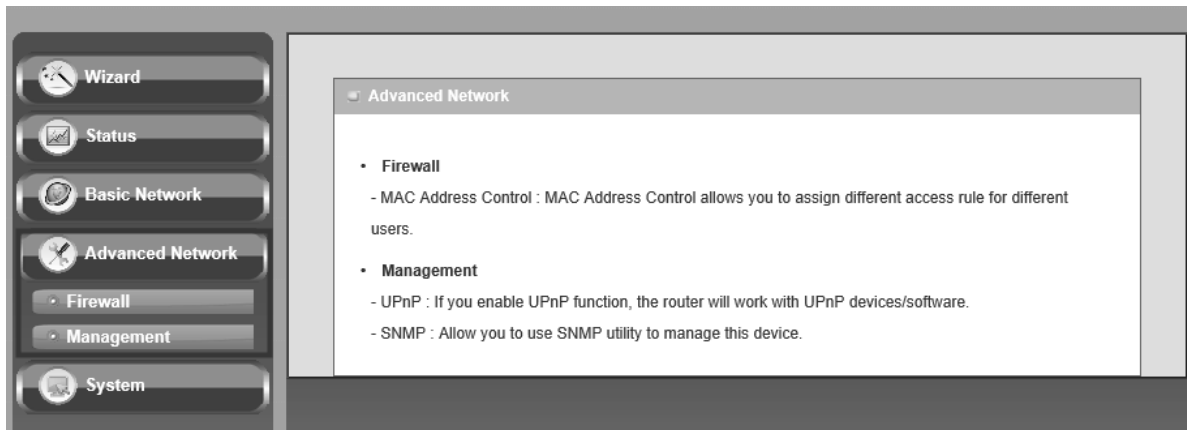

3.2.1 Firewall

3.2.1.1 MAC Address Control

MAC Address Control allows you to assign different access right for different users and to assign a specific IP address to a certain MAC address.

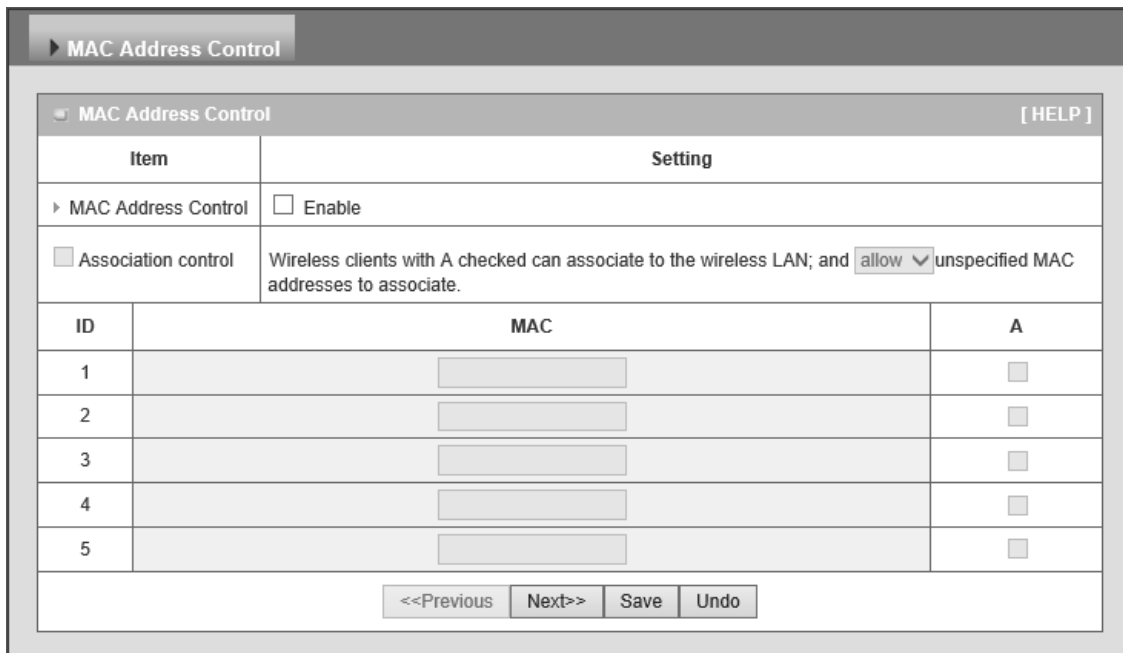

MAC Address Control [HELP]		
Item	Setting	
▶ MAC Address Control	<input type="checkbox"/> Enable	
<input type="checkbox"/> Association control	Wireless clients with A checked can associate to the wireless LAN; and <input type="button" value="allow"/> unspecified MAC addresses to associate.	
ID	MAC	A
1	<input type="text"/>	<input type="checkbox"/>
2	<input type="text"/>	<input type="checkbox"/>
3	<input type="text"/>	<input type="checkbox"/>
4	<input type="text"/>	<input type="checkbox"/>
5	<input type="text"/>	<input type="checkbox"/>

1. **MAC Address Control:** Check “Enable” to enable the “MAC Address Control”. All of the settings in this page will take effect only when “Enable” is checked.
2. **Association control:** Check "Association control" to enable the control of which wireless client can associate to the wireless LAN. If a client is denied to associate to the wireless LAN, it means the client can't send or receive any data via this device. Choose "allow" or "deny" to allow or deny the clients, whose MAC addresses are not in the "Control table", to associate to the wireless LAN.

Afterwards, click on “Save” to store your settings or click “Undo” to give up the changes.

3.2.2 Management

3.2.2.1 UPnP

UPnP Internet Gateway Device (IGD) Standardized Device Control Protocol is a NAT port mapping protocol and is supported by some Network device. It is a common communication protocol of automatically configuring port forwarding. Applications using peer-to-peer networks, multiplayer gaming, and remote assistance programs need a way to communicate through home and business gateways. Without IGD one has to manually configure the gateway to allow traffic through, a process which is error prone and time consuming

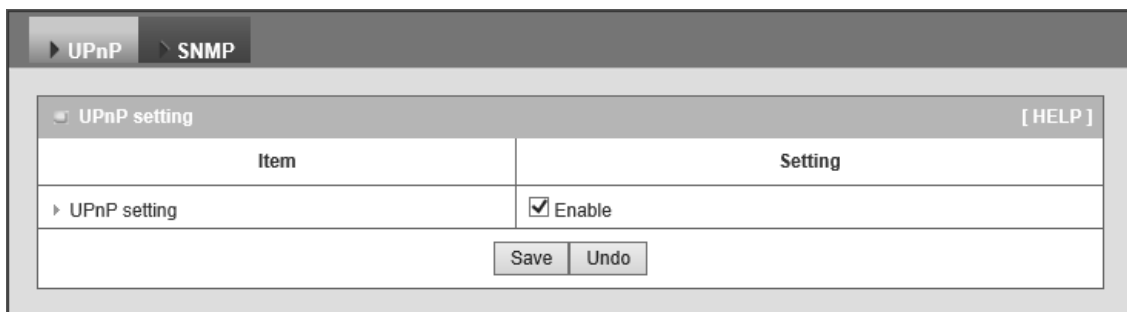

The screenshot shows a web management interface for UPnP settings. At the top, there are tabs for 'UPnP' and 'SNMP'. Below the tabs, there is a section titled 'UPnP setting' with a '[HELP]' link. A table with two columns, 'Item' and 'Setting', is displayed. The table contains one row: 'UPnP setting' with a checked checkbox and the text 'Enable'. At the bottom of the table, there are 'Save' and 'Undo' buttons.

Item	Setting
UPnP setting	<input checked="" type="checkbox"/> Enable

This device supports the UPnP Internet Gateway Device (IGD) feature. By default, it is enabled.

3.2.2.2 SNMP

In brief, SNMP, the Simple Network Management Protocol, is a protocol designed to give a user the capability to remotely manage a computer network by polling and setting terminal values and monitoring network events.

UPnP ▶ SNMP	
SNMP Setting [HELP]	
Item	Setting
▶ Enable SNMP	<input checked="" type="checkbox"/> Local
▶ SNMP Version	<input checked="" type="checkbox"/> v1 <input checked="" type="checkbox"/> v2c <input type="checkbox"/> v3
▶ Get Community	<input type="text" value="public"/>
▶ Set Community	<input type="text" value="private"/>
SNMP Setting	
▶ User 1	<input type="checkbox"/> Enable
▶ SNMPv3 Settings: User 1	<input checked="" type="radio"/> Read <input type="radio"/> Read/Write
▶ User 1 AUTH Mode	<input checked="" type="radio"/> MD5 <input type="radio"/> SHA
▶ User 1 Privacy Mode	<input type="radio"/> noAuthNoPriv <input checked="" type="radio"/> authNoPriv <input type="radio"/> authPriv
▶ Username 1	<input type="text"/>
▶ Password 1(len>=8)	<input type="text"/>
▶ User 1 Priv Key	<input type="text"/>

SNMP Setting	
▶ User 2	<input type="checkbox"/> Enable
▶ SNMPv3 Settings: User 2	<input checked="" type="radio"/> Read <input type="radio"/> Read/Write
▶ User 2 AUTH Mode	<input checked="" type="radio"/> MD5 <input type="radio"/> SHA
▶ User 2 Privacy Mode	<input type="radio"/> noAuthNoPriv <input checked="" type="radio"/> authNoPriv <input type="radio"/> authPriv
▶ Username 2	<input type="text"/>
▶ Password 2(len>=8)	<input type="text"/>
▶ User 2 Priv Key	<input type="text"/>
IP	
▶ IP 1	<input type="text"/>
▶ IP 2	<input type="text"/>
▶ IP 3	<input type="text"/>
▶ IP 4	<input type="text"/>
<input type="button" value="Save"/> <input type="button" value="Undo"/>	

1. **Enable SNMP:** Enable this Function.
2. **SNMP Version:** Supports SNMP V1, V2c, and V3.
3. **Get Community:** The community of GetRequest that this device will respond. This is a text password mechanism that is used to weakly authenticate queries to agents of managed network devices.
4. **Set Community:** The community of SetRequest that this device will accept.
5. **SNMPv3 Settings: User 1/2:** This device supports up to two SNMP management accounts. You can specify the account permission as “Read” or “Read/Write” respectively.
6. **User 1/2 AUTH Mode:** Select MD5 or SHA as the method of password encryption for the specified level of access, or to disable authentication.
7. **User 1/2 Privacy Mode:** You can configure the SNMP privacy mode. There are three modes for you to choose: “noAuthNoPriv” for both authentication and private key are not required, “authNoPriv” for no private key required, and “authPriv” for both authentication and private key required.
8. **Username 1/2:** Use this field to identify the user name for the specified level of access.
9. **Password 1/2:** Use this field to set the password for the specified level of access.
10. **User 1/2 Priv Key:** Use this field to define the encryption key for the specified level of access.
11. **IP (Trap Event Receiver) 1 ~ 4:** Enter the IP addresses or Domain Name of your SNMP Management PCs. You have to specify the IP address, so that the device can send SNMP

Trap message to the management PCs consequently.

Afterwards, click on “**Save**” to store your settings or click “**Undo**” to give up the changes.

3.3 System

In this section you can see system information, system logs, use system tools for system update and do service scheduling and system administration setting.

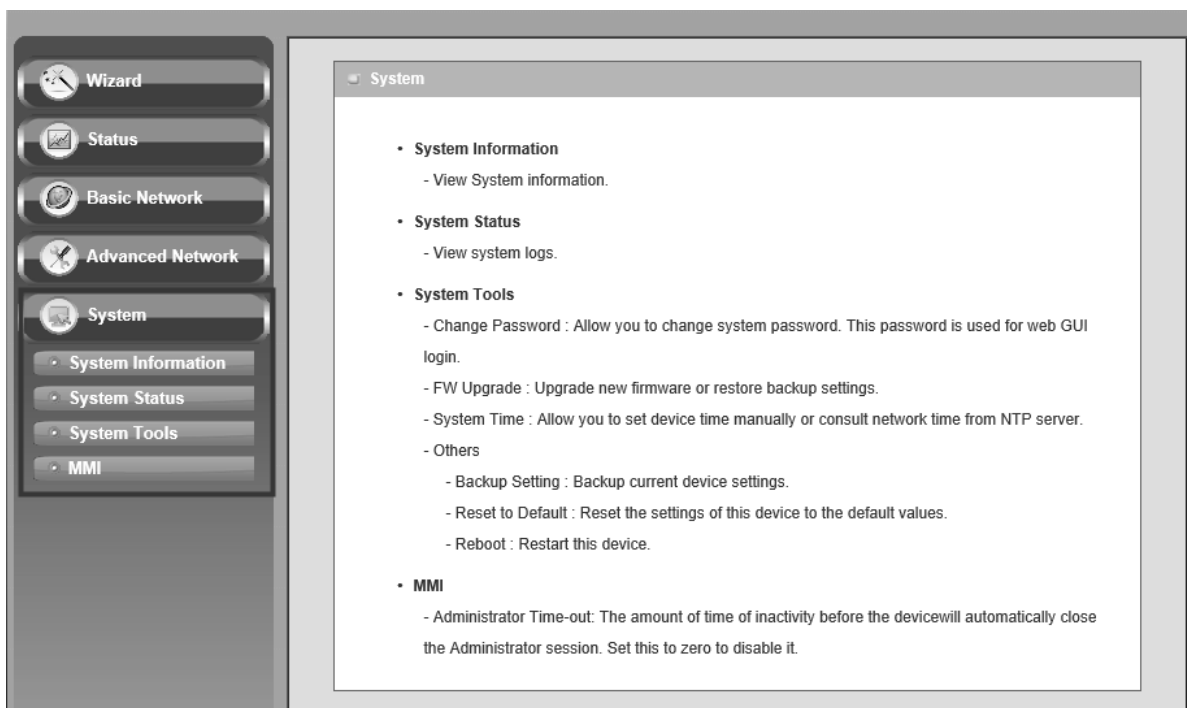

3.3.1 System Information

You can view the System Information in this page.

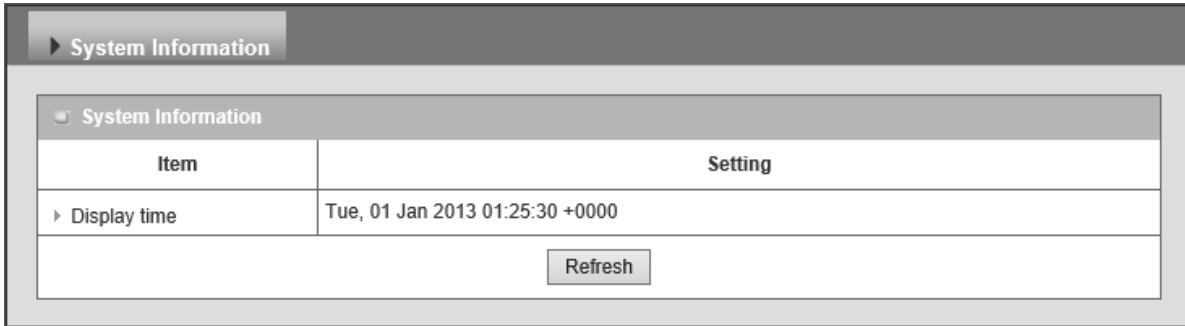

Item	Setting
Display time	Tue, 01 Jan 2013 01:25:30 +0000

Refresh

3.3.2 System Status

3.3.2.1 Web Log

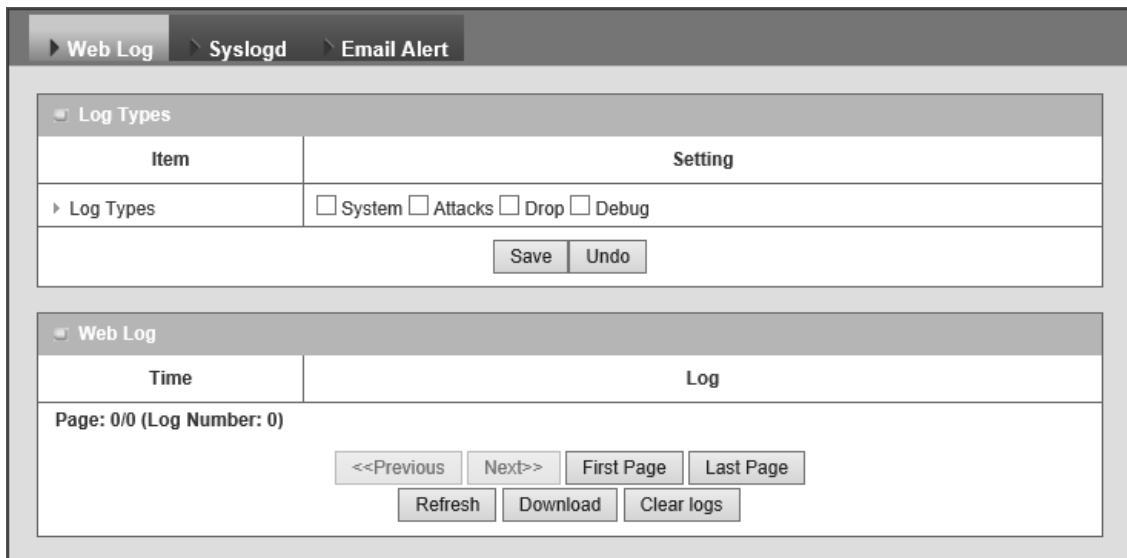

Item	Setting
Log Types	<input type="checkbox"/> System <input type="checkbox"/> Attacks <input type="checkbox"/> Drop <input type="checkbox"/> Debug

Save Undo

Time	Log
Page: 0/0 (Log Number: 0)	

<<Previous Next>> First Page Last Page
 Refresh Download Clear logs

1. **Log Types:** You can select the log types to be collected in the web log area. There are “System”, “Attacks”, “Drop”, and “Debug” types for you to select.
2. **Web Log:** You can browse, refresh, download, and clear the log messages.

3.3.2.2 Syslog

This device also can export system logs to specific destination by means of syslog (UDP) and SMTP(TCP). With enabled Syslog function, this device will send log to a certain host periodically. You need to install a syslog utility on a host to receive syslogs.

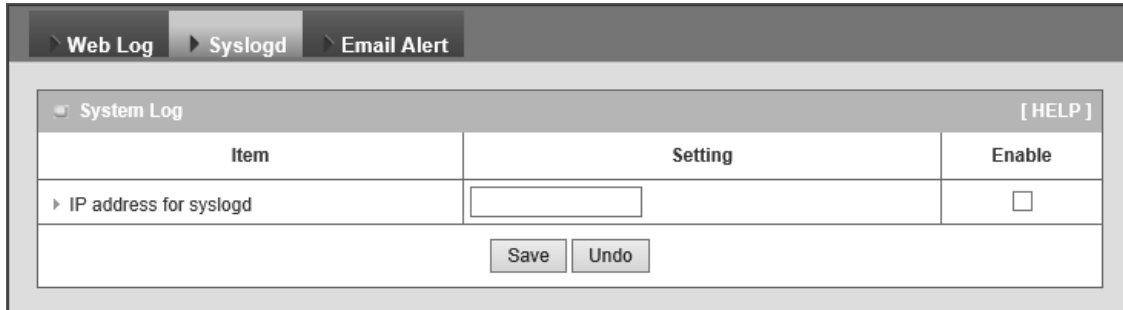

Item	Setting	Enable
▶ IP address for syslogd	<input type="text"/>	<input type="checkbox"/>

The items you have to setup include:

1. **IP Address for syslogd:** Host IP of destination where syslog will be sent to. Check **Enable** to enable this function.

3.3.2.3 Email Alert

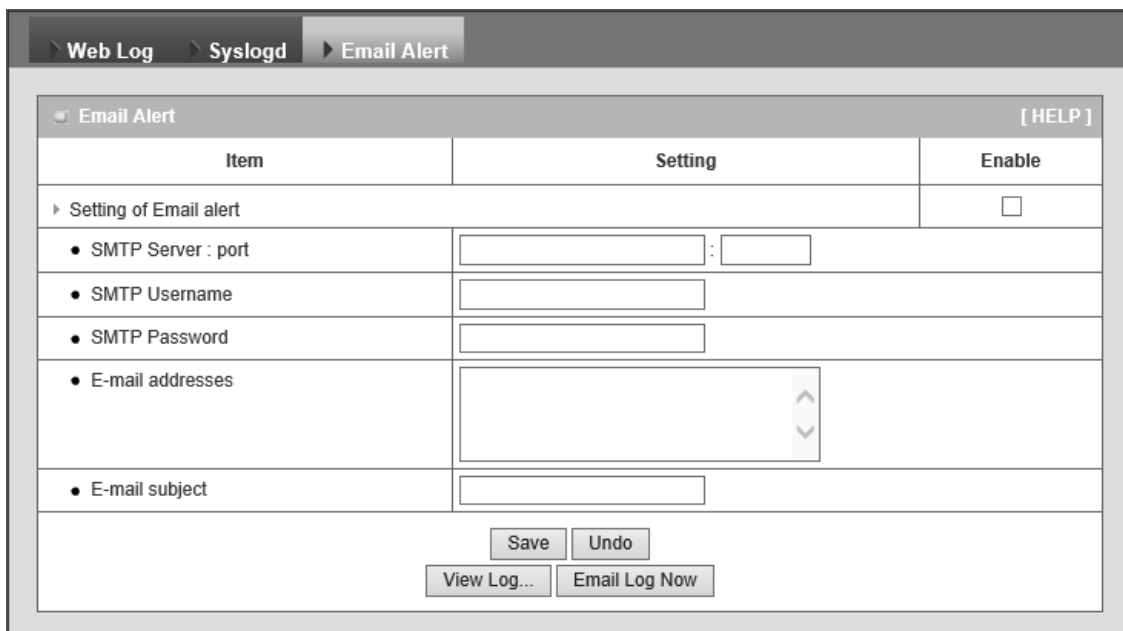

Item	Setting	Enable
▶ Setting of Email alert		<input type="checkbox"/>
• SMTP Server : port	<input type="text"/> : <input type="text"/>	
• SMTP Username	<input type="text"/>	
• SMTP Password	<input type="text"/>	
• E-mail addresses	<input type="text"/>	
• E-mail subject	<input type="text"/>	

This device can also export system logs via sending emails to specific recipients. The items you have to setup include:

1. **Setting of Email alert:** Check if you want to enable Email alert (send syslog via email).
2. **SMTP Server: Port:** Input the SMTP server IP and port, which are connected with ':'. If you do not specify port number, the default value is 25.
For example, "mail.your_url.com" or "192.168.1.100:26".
3. **SMTP Username:** Enter the Username offered by your ISP.
4. **SMTP Password:** Enter the password offered by your ISP.
5. **E-mail Addresses:** The recipients are the ones who will receive these logs. You can assign more than 1 recipient, using ';' or ',' to separate these email addresses.
6. **E-mail Subject:** The subject of email alert is optional.

Afterwards, click on “Save” to store your settings or click “Undo” to give up the changes.

3.3.3 System Tools

3.3.3.1 Change Password

You can change the System Password here. We **strongly** recommend you to change the system password for security reason. Click on “Save” to store your settings or click “Undo” to give up the changes.

Item	Setting
▶ Old Password	<input type="text"/>
▶ New Password	<input type="text"/>
▶ Reconfirm	<input type="text"/>

3.3.3.2 FW Upgrade

If new firmware is available, you can upgrade device firmware through the WEB GUI here.

Change Password | FW Upgrade | System Time | Others

Firmware Upgrade [HELP]

Firmware Filename

浏览...

Current firmware version is **00QL0.1004_02281700.**

Note! Do not interrupt the process or power off the unit when it is being upgraded.
When the process is done successfully, the unit will be restarted automatically.

Accept unofficial firmware.

Upgrade Cancel

Press “browse” button to indicate the file name of new firmware, and then press Upgrade button to start to upgrade new firmware on this device. If you want to upgrade a firmware which is from GPL policy, please check “Accept unofficial firmware”.

NOTE. PLEASE DO NOT TURN THE DEVICE OFF WHEN UPGRADE IS PROCEEDING.

3.3.3.3 System Time

If new firmware is available, you can upgrade device firmware through the WEB GUI here.

Item	Setting
▶ Time Zone	* Not yet configured! The default is GMT+00:00
▶ Auto-Synchronization	<input checked="" type="checkbox"/> Enable Time Server (RFC-868): Auto
▶ Daylight saving time	<input type="checkbox"/>
▶ Date And Time Manually	2014 / March / 11 (Year/Month/Day) 18 : 13 : 49 (Hour:Minute:Second)

Save Undo

Sync with Time Server Sync with my PC (Tuesday March 11, 2014 18:13:52)

1. **Time Zone:** Select a time zone where this device locates.
2. **Auto-Synchronization:** Check the “Enable” checkbox to enable this function. Besides, you can select a NTP time server to consult UTC time.
3. **Sync with Time Server:** Click on the button if you want to set Date and Time by NTP Protocol.
4. **Sync with my PC:** Click on the button if you want to set Date and Time using the PC’s Date and Time.

Afterwards, click on “**Save**” to store your settings or click “**Undo**” to give up the changes.

3.3.3.4 Others

In this section you can do system backup, reset to default, system reboot settings and ping test.

Change Password FW Upgrade System Time Others	
Others [HELP]	
Item	Setting
▶ Backup Setting	<input type="button" value="Backup"/>
▶ Reset to Default	<input type="button" value="Reset"/>
▶ Reboot	<input type="button" value="Reboot"/>
▶ Domain Name or IP address for Ping Test	<input type="text"/> <input type="button" value="Ping"/>
▶ Domain Name or IP address for Traceroute	<input type="text"/> <input type="button" value="Traceroute"/>

1. **Backup Setting:** You can backup your settings by clicking the “**Backup**” button and save it as a bin file. Once you want to restore these settings, please click Firmware Upgrade button and use the bin file you saved.
2. **Reset to Default:** You can also reset this device to factory default settings by clicking the “**Reset**” button.
3. **Reboot:** You can also reboot this device by clicking the “**Reboot**” button.
4. **Domain Name or IP address for Ping Test:** This allows you to configure an IP, and ping the device. You can ping a specific IP to test whether it is alive.
5. **Domain Name or IP address for Traceroute:** Traceroute is a network diagnostic tool for displaying the route (path) and measuring transit delays of packets across an IP network. Traceroute proceeds unless all (three) sent packets are lost more than twice, then the connection is lost and the route cannot be evaluated. Ping, on the other hand, only computes the final round-trip times from the destination point

3.3.4 MMI

3.3.4.1 Web UI

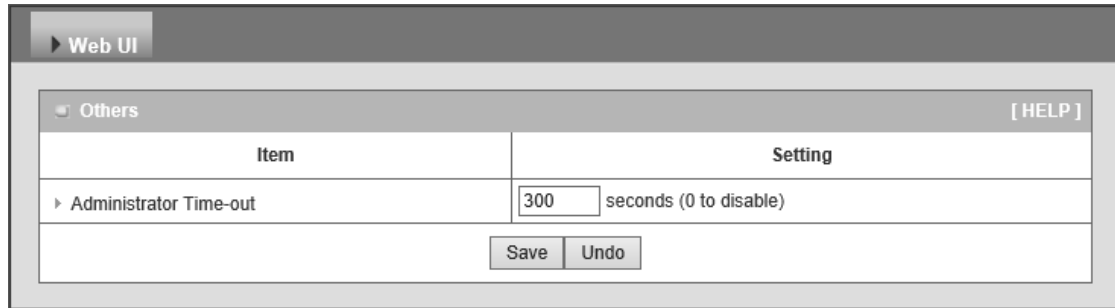

The screenshot shows a web interface for configuring settings. At the top, there is a tab labeled 'Web UI'. Below it, a section titled 'Others' contains a table with two columns: 'Item' and 'Setting'. The table has one row with the item 'Administrator Time-out' and a setting of '300 seconds (0 to disable)'. Below the table are 'Save' and 'Undo' buttons. A '[HELP]' link is located in the top right corner of the 'Others' section.

Item	Setting
▶ Administrator Time-out	<input type="text" value="300"/> seconds (0 to disable)

Save Undo

You can set UI administration time-out duration in this page. If the value is “0”, means the time-out is unlimited.

4 Troubleshooting

This Chapter provides solutions to problems for the installation and operation of the WiFi Concurrent N300 Business AP. You can refer to the following if you are having problems.

1 Why can't I configure the device even the cable is plugged and the LED is lit?

Do a **Ping test** to make sure that the WiFi Access Point is responding.

Note: It is recommended that you

Go to **Start > Run**.

1. Type **cmd**.

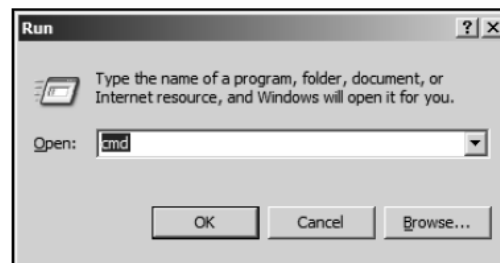

2. Press **OK**.
3. Type **ipconfig** to get the IP of default gateway.
4. Type **“ping 192.168.123.50”**. Assure that you ping the correct IP Address assigned to the WiFi Concurrent N300 Business AP. It will show four replies if you ping correctly.

```
Pinging 192.168.123.254 with 32 bytes of data:  
Reply from 192.168.123.50: bytes=32 time<1ms TTL=64  
Reply from 192.168.123.50: bytes=32 time<1ms TTL=64  
Reply from 192.168.123.50: bytes=32 time<1ms TTL=64  
Reply from 192.168.123.50: bytes=32 time<1ms TTL=64
```

Ensure that your Ethernet Adapter is working, and that all network drivers are installed

properly. Network adapter names will vary depending on your specific adapter. The installation steps listed below are applicable for all network adapters.

1. Go to **Start > Right click on “My Computer” > Properties**.
2. **Select the Hardware Tab**.
3. Click **Device Manager**.
4. Double-click on **“Network Adapters”**.
5. Right-click on **Wireless Card bus Adapter** or **your specific network adapter**.
6. Select **Properties** to ensure that all drivers are installed properly.
7. Look under **Device Status** to see if the device is working properly.
8. Click **“OK”**.

2 What can I do if my Ethernet connection does not work properly?

- A. Make sure the RJ45 cable connects with the device.
- B. Ensure that the setting on your Network Interface Card adapter is “Enabled”.
- C. If settings are correct, ensure that you are not using a crossover Ethernet cable, not all Network Interface Cards are MDI/MDIX compatible, and use a patch cable is recommended.
- D. If the connection still doesn't work properly, then you can reset it to default.

3 Something wrong with the wireless connection?

A. Can't setup a wireless connection?

- I. Ensure that the SSID and the encryption settings are exactly the same to the Clients.
- II. Move the WiFi Concurrent N300 Business AP and the wireless client into the same room, and then test the wireless connection.

- III. Disable all security settings such as **WEP**, and **MAC Address Control**.
- IV. Turn off the WiFi Concurrent N300 Business AP and the client, then restart it and then turn on the client again.
- V. Ensure that the LEDs are indicating normally. If not, make sure that the power and Ethernet cables are firmly connected.
- VI. Ensure that the IP Address, subnet mask, gateway and DNS settings are correctly entered for the network.
- VII. If you are using other wireless device, home security systems or ceiling fans, lights in your home, your wireless connection may degrade dramatically. Keep your product away from electrical devices that generate RF noise such as microwaves, monitors, electric motors...

B. What can I do if my wireless client can not access the Internet?

- I. Out of range: Put the device closer to your client.
- II. Wrong SSID or Encryption Key: Check the SSID or Encryption setting.
- III. Connect with wrong AP: Ensure that the client is connected with the correct Access Point.
 - i. **Right-click** on the **Local Area Connection icon** in the taskbar.
 - ii. Select **View Available Wireless Networks in Wireless Configure**. Ensure you have selected the correct available network.
 - iii. Reset the WiFi Concurrent N300 Business AP to default setting

C. Why does my wireless connection keep dropping?

- I. Antenna Orientation.
 - i. Try different antenna orientations for the WiFi Concurrent N300 Business AP.
 - ii. Try to keep the antenna at least 6 inches away from the wall or other objects.

- II. Try changing the channel on the WiFi Concurrent N300 Business AP, and your Access Point and Wireless adapter to a different channel to avoid interference.
- III. Keep your product away from electrical devices that generate RF noise, like microwaves, monitors, electric motors, etc.

4 What to do if I forgot my encryption key?

1. Go back to advanced setting to set up your Encryption key again.
2. Reset the WiFi Concurrent N300 Business AP to default setting

5 How to reset to default?

1. Ensure the WiFi Concurrent N300 Business AP is powered on
2. Find the **Reset** button on the right side
3. Press the **Reset** button for 8 seconds and then release.
4. After the WiFi Concurrent N300 Business AP reboots, it has back to the factory **default** settings.

Appendix A. Assigning a Static IP in Windows PC

When organizing your local network it's easier to assign each computer it's own IP address than using DHCP. Here we will take a look at doing it in XP, Windows 7, Windows 8 and Windows 8.1.

If you have a home network with several computes and devices, it's a good idea to assign each of them a specific address. If you use DHCP (*Dynamic Host Configuration Protocol*), each computer will request and be assigned an address every time it's booted up. When you have to do troubleshooting on your network, it's annoying going to each machine to figure out what IP they have.

Using Static IPs prevents address conflicts between devices and allows you to manage them more easily. Assigning IPs to Windows is essentially the same process, but getting to where you need to be varies between each version.

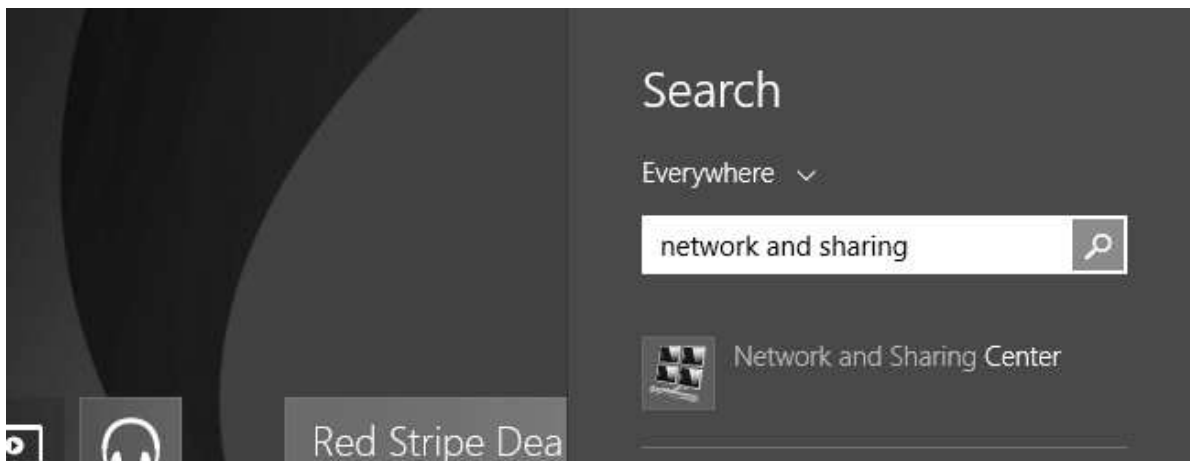

Windows 7 or Windows 8.x

To change the computer's IP address in Windows 7, type *network and sharing* into the Search box in the Start Menu and select Network and Sharing Center when it comes up. If you are in Windows 8.x it will be on the Start Screen itself, like the screenshot at the top of this article.



Then when the Network and Sharing Center opens, click on *Change adapter settings*. This will be the same on Windows 7 or 8.x.

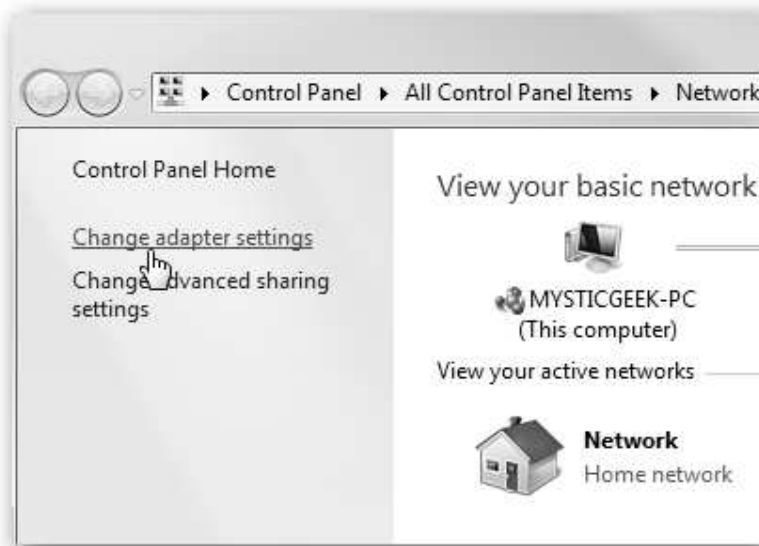

Right-click on your local adapter and select Properties.

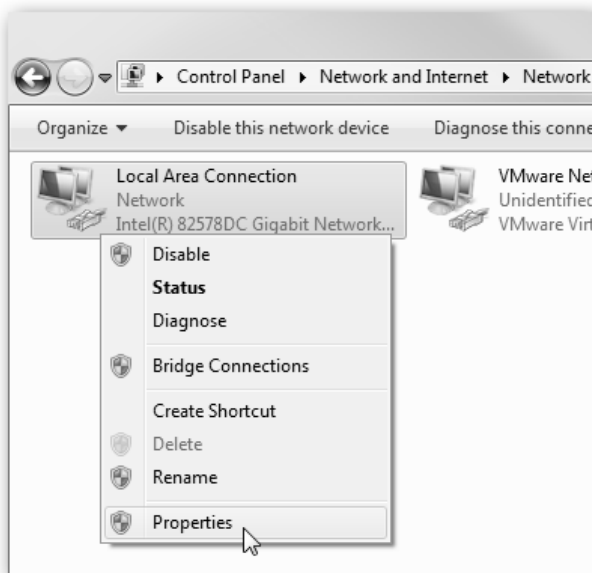

In the Local Area Connection Properties window highlight *Internet Protocol Version 4 (TCP/IPv4)* then click the Properties button.

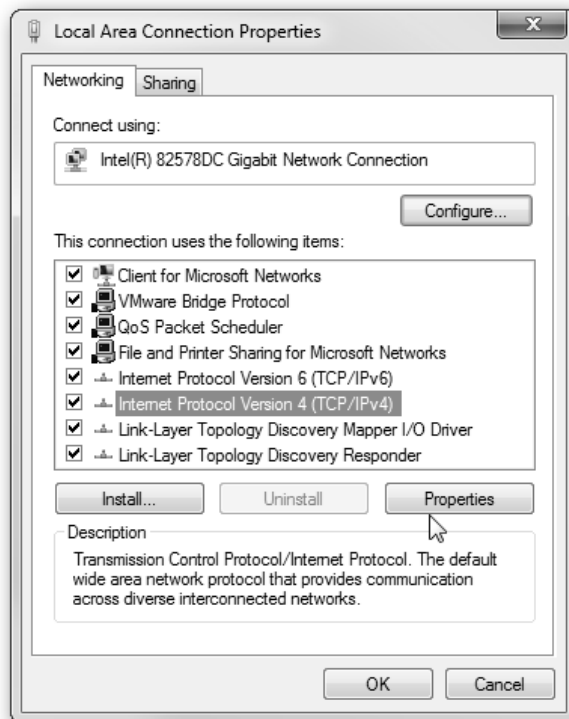

Now select the radio button *Use the following IP address* and enter in the correct IP, Subnet mask, and Default gateway that corresponds with your network setup. Then enter your Preferred and Alternate DNS server addresses. Here we're on a home network and using a simple Class C network configuration and Google DNS.

Check *Validate settings upon exit* so Windows can find any problems with the addresses you entered. When you're finished click OK.

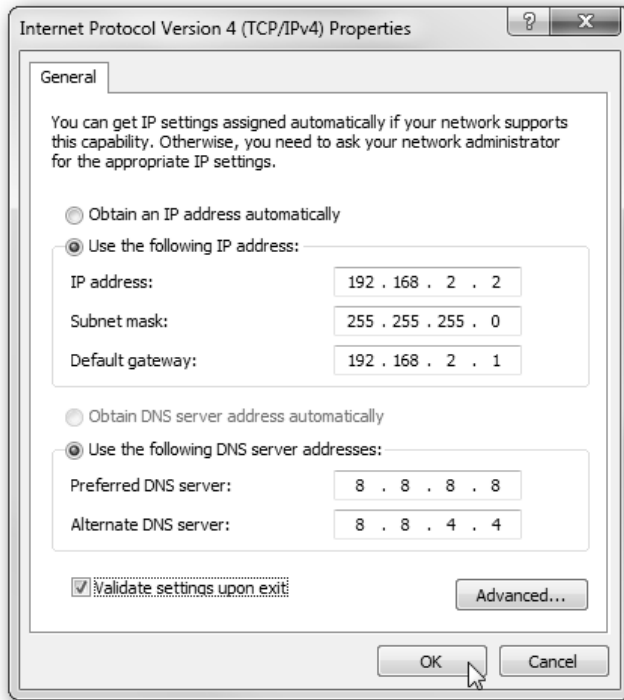

Now close out of the Local Area Connections Properties window.

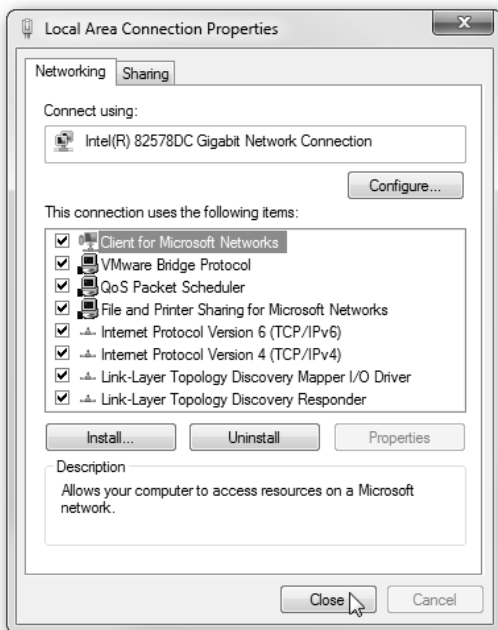

Windows 7 will run network diagnostics and verify the connection is good. Here we had no problems with it, but if you did, you could run the network troubleshooting wizard.

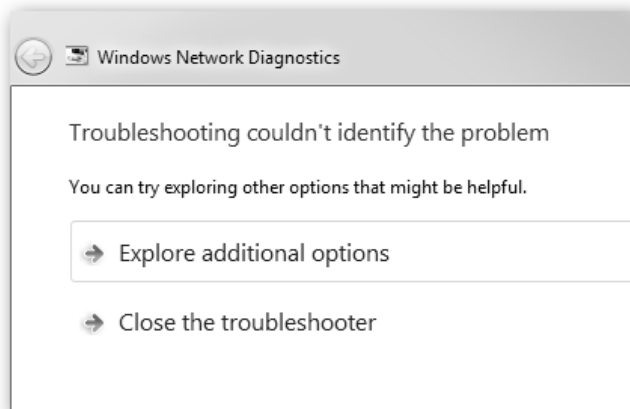

Now you can open the command prompt and do an *ipconfig* to see the network adapter settings have been successfully changed.

```
Windows IP Configuration

Ethernet adapter Local Area Connection:

    Connection-specific DNS Suffix . . . . . : 
    Link-local IPv6 Address . . . . . : fe80::11e3:1d23:a
    IPv4 Address. . . . . : 192.168.2.2
    Subnet Mask . . . . . : 255.255.255.0
    Default Gateway . . . . . : 192.168.2.1
```

Windows XP

In this example we're using XP SP3 Media Center Edition and changing the IP address of the Wireless adapter.

To set a Static IP in XP right-click on My Network Places and select Properties.



Right-click on the adapter you want to set the IP for and select Properties.

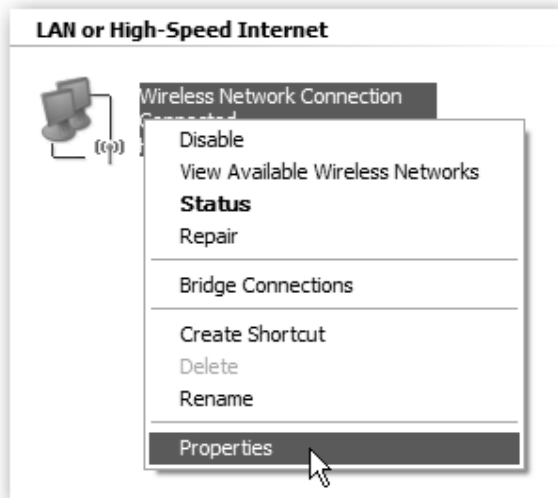

Highlight *Internet Protocol (TCP/IP)* and click the Properties button.

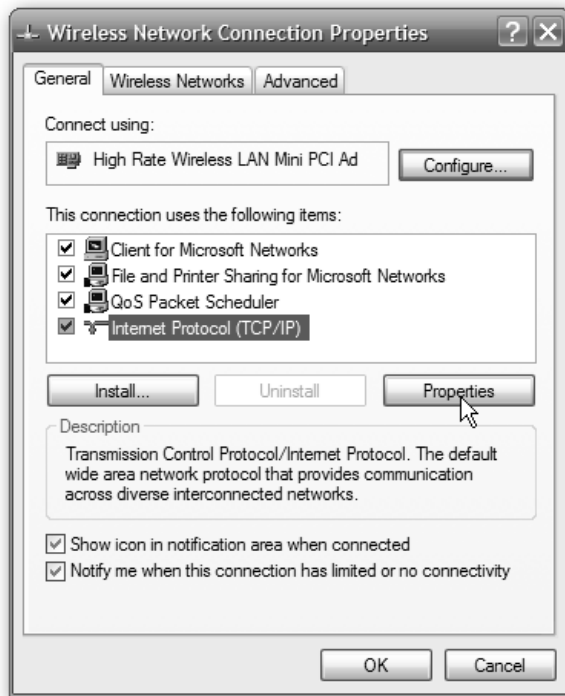

Now change the IP, Subnet mask, Default Gateway, and DNS Server Addresses. When you're finished click OK.

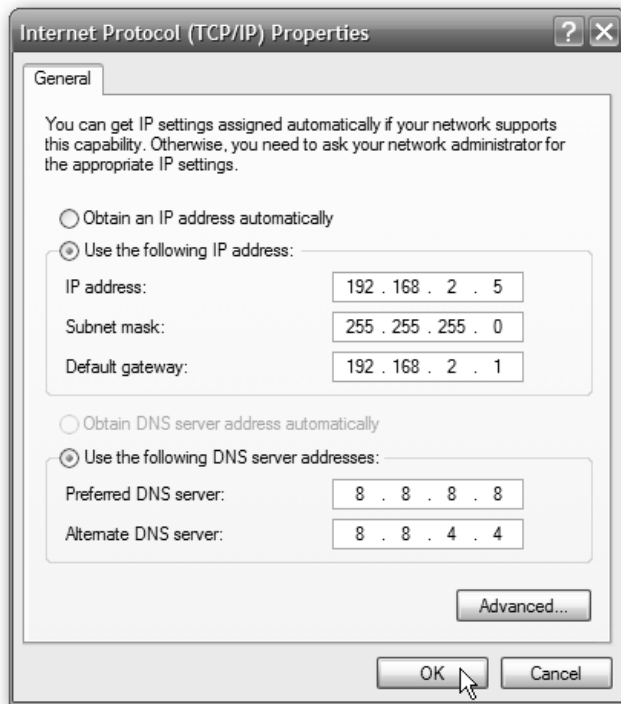

You will need to close out of the Network Connection Properties screen before the changes go into effect.

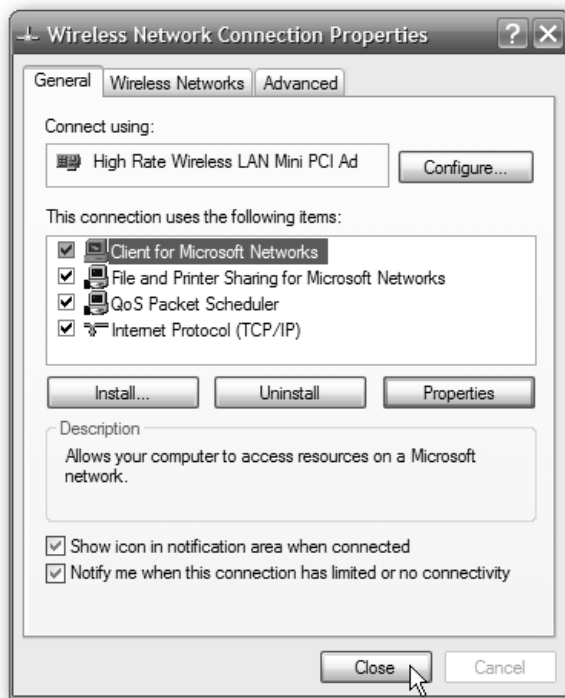

Again you can verify the settings by doing an *ipconfig* in the command prompt. In case you're not sure how to do this, click on Start then Run.

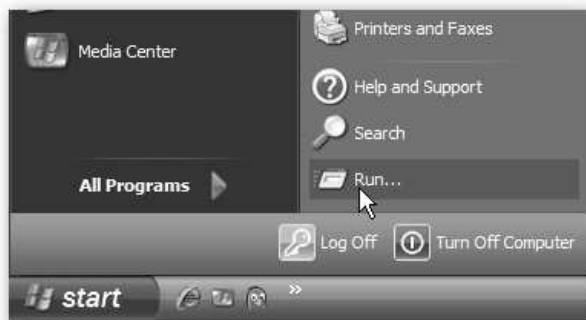

In the Run box type in *cmd* and click OK.

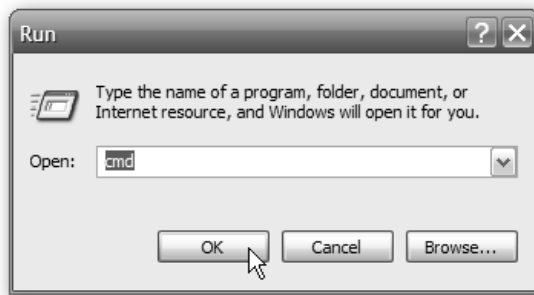

Then at the prompt type in *ipconfig* and hit Enter. This will show the IP address for the network adapter you changed.

```
C:\Documents and Settings\XP Geek>ipconfig
Windows IP Configuration

Ethernet adapter Wireless Network Connection:

    Connection-specific DNS Suffix  . : 
    IP Address . . . . . : 192.168.2.5
    Subnet Mask . . . . . : 255.255.255.0
    Default Gateway . . . . . : 192.168.2.1

C:\Documents and Settings\XP Geek>
```

If you have a small office or home network, assigning each computer a specific IP address makes it a lot easier to manage and troubleshoot network connection problems.

[Source: How to Assign a Static IP Address in Windows 7, 8, XP, or Vista; <http://www.howtogeek.com/howto/19249/how-to-assign-a-static-ip-address-in-xp-vista-or-windo-ws-7/>]

Warranty Information

Please refer www.digisol.com for warranty information in your region.