

AR-7286WnA / AR-7286WnB

User Manual

6-2013 / v1.0



COPYRIGHT

Copyright © Edimax Technology Co., Ltd. all rights reserved. No part of this publication may be reproduced, transmitted, transcribed, stored in a retrieval system, or translated into any language or computer language, in any form or by any means, electronic, mechanical, magnetic, optical, chemical, manual or otherwise, without the prior written permission from Edimax Technology Co., Ltd.

Edimax Technology Co., Ltd. makes no representations or warranties, either expressed or implied, with respect to the contents hereof and specifically disclaims any warranties, merchantability, or fitness for any particular purpose. Any software described in this manual is sold or licensed as is. Should the programs prove defective following their purchase, the buyer (and not this company, its distributor, or its dealer) assumes the entire cost of all necessary servicing, repair, and any incidental or consequential damages resulting from any defect in the software. Edimax Technology Co., Ltd. reserves the right to revise this publication and to make changes from time to time in the contents hereof without the obligation to notify any person of such revision or changes.

The product you have purchased and the setup screen may appear slightly different from those shown in this QIG. For more information about this product, please refer to the user manual on the CD-ROM. The software and specifications are subject to change without notice. Please visit our website www.edimax.com for updates. All brand and product names mentioned in this manual are trademarks and/or registered trademarks of their respective holders.

Edimax Technology Co., Ltd.

Add: No. 3, Wu-Chuan 3rd Rd., Wu-Ku Industrial Park, New Taipei City, Taiwan

Tel: +886-2-77396888

Email: sales@edimax.com.tw

Contents

1. PRODUCT INTRODUCTION	5
1.1. PACKAGE CONTENTS.....	5
1.2. SYSTEM REQUIREMENTS.....	5
1.3. SAFETY PRECAUTIONS	5
1.4. LED STATUS & BUTTON DEFINITIONS	6
1.5. FEATURES.....	9
2. HARDWARE INSTALLATION.....	10
3. IP ADDRESS SETTING	17
3.1. WINDOWS 8.....	17
3.2. WINDOWS 7.....	20
3.3. WINDOWS VISTA.....	21
3.4. WINDOWS XP.....	22
4. EZMAX SETUP WIZARD	24
4.1. SETUP WIZARD.....	24
4.2. INTERNET CONNECTION TYPE	29
4.2.1. PPoE/PPPoA.....	31
4.2.2. Bridge Mode	32
4.2.3. Dynamic IP Address.....	33
4.2.4. Static IP.....	34
4.3. FIRMWARE UPGRADE	35
5. WEB CONFIGURATION	37
5.1. ACCESSING THE ROUTER.....	37
5.2. STATUS.....	37
5.2.1. Device Info	37
5.2.2. System Log.....	38
5.2.3. Statistics.....	39
5.3. QUICK START	40
5.3.1. Auto setup by ISP list.....	42
5.3.2. Bridge Mode	43
5.3.3. Dynamic IP Address.....	44
5.3.4. PPPoE/PPPoA.....	45
5.4. INTERFACE SETUP.....	46
5.4.1. Internet.....	46
5.4.2. LAN.....	56

5.4.3. Wireless.....	60
5.5. ADVANCED SETUP.....	62
5.5.1. Firewall.....	63
5.5.2. Routing.....	63
5.5.3. NAT.....	64
5.5.4. QoS.....	68
5.5.5. VLAN.....	73
5.5.6. ADSL.....	75
5.6. ACCESS MANAGEMENT.....	76
5.6.1. ACL.....	76
5.6.2. Filter.....	77
5.6.3. SNMP.....	80
5.6.4. UPnP.....	81
5.6.5. DDNS.....	82
5.6.6. CWMP.....	82
5.7. MAINTENANCE.....	84
5.7.1. Administration.....	84
5.7.2. Time Zone.....	84
5.7.3. Firmware.....	85
5.7.4. SysRestart.....	86
5.7.5. Diagnostics.....	87
6. TROUBLE SHOOTING.....	88

Note: The images/screenshots used in this manual are for reference only – actual screens may vary according to firmware version. The contents of this manual are based on the most recent firmware version at the time of writing.

1. Product Introduction

1.1. Package Contents

Before you start using this product, please check if there is anything missing in the package and contact your dealer to claim the missing item(s):

- ADSL2+ router (AR-7286WnA or AR-7286WnB)
- 12V power adapter
- 1 meter RJ-45 Ethernet cable
- 1.8M RJ-11 telephone line x 2
- Quick installation guide
- CD containing setup wizard, user manual & multi-language QIG
- Splitter
- 5dBi antenna x 2

1.2. System Requirements

Recommended system requirements are as follows.

- A 10/100 base-T Ethernet card installed in your PC.
- A hub or Switch (connected to several PCs through one of the Ethernet interfaces on the device).
- Operating system: Windows 98 SE, Windows 2000, Windows ME, Windows XP, Windows 7, Windows 8.
- Internet Explorer V5.0 or higher, Netscape V4.0 or higher or Firefox 1.5 or higher.

1.3. Safety Precautions

Follow the following instructions to prevent the device from risks and damage caused by fire or electric power:

- Use volume labels to mark the type of power.
- Use the power adapter included within the package contents.
- Pay attention to the power load of the outlet or prolonged lines. An overburdened power outlet or damaged lines and plugs may cause an electric shock or fire. Check the power cords regularly. If you find any damage, replace it at once.
- Proper space left for heat dissipation is necessary to avoid damage caused by overheating to the device. The long and thin holes on the device are designed for heat dissipation to ensure that the device works normally. Do not cover these heat dissipation holes.

- Do not put this device close to heat sources or high temperatures. Keep the device out of direct sunshine.
- Do not put this device close to a place where it is damp or wet. Do not spill any fluid on this device.
- Do not connect this device to any PCs or electronic products, other than those which you are instructed or recommended to do so in the product's documentation, by our customer engineers or by your broadband provider – connecting to incorrect devices may cause a fire risk.
- Place this device on a stable surface.

1.4. LED Status & Button Definitions

Front Panel

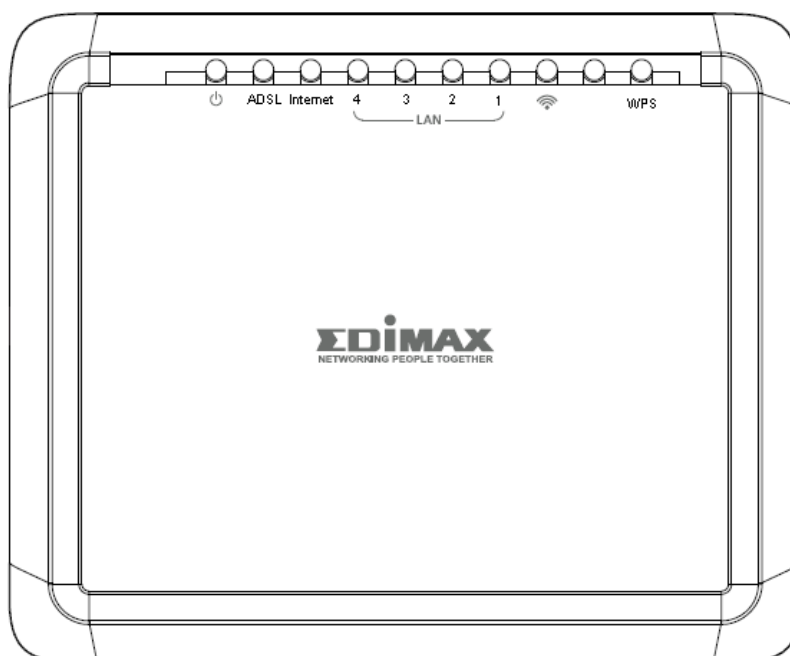

LED	Color	Status	Description
Power 	Green	On	ADSL2+ router is on.
		Off	ADSL2+ router is off.
	Red	On	ADSL broadband initial self-test failed or upgrading firmware.
ADSL	Green	On	ADSL line is synchronized and ready to use.
		Slow Flashing	ADSL synchronization failed (please refer to <i>Note i.</i> below)
		Quick Flashing	ADSL negotiation is in progress.

Internet	Green	On	Internet connected in router mode
		Flashing	Internet activity (transferring/receiving data) in router mode.
		Off	Device in bridged mode.
	Red	On	Internet not connected in router mode (Please refer to <i>Note ii.</i> below).
LAN1–4	Green	On	LAN port connected.
		Flashing	LAN activity (transferring/receiving data).
		Off	LAN port not connected.
WLAN 	Green	On	Successful WLAN connection.
		Flashing	WLAN activity (transferring/receiving data).
		Off	WLAN connection failed.
WPS	Green	Off	WPS is disabled.
		Flashing	WPS is enabled and waiting for client to negotiate.

 **Note i.**



If the ADSL LED is off, please check your Internet connection. Refer to A. Hardware Installation for more information about how to connect the router correctly. If all connections are correct, please contact your ISP to check if there is a problem with your Internet service.

ii.

If the Internet LED is red, please check your ADSL LED first. If the ADSL LED is off, refer to Note 1. If the green ADSL LED is ON, please check your Internet configuration. You may need to check with your ISP that your Internet is configured correctly.

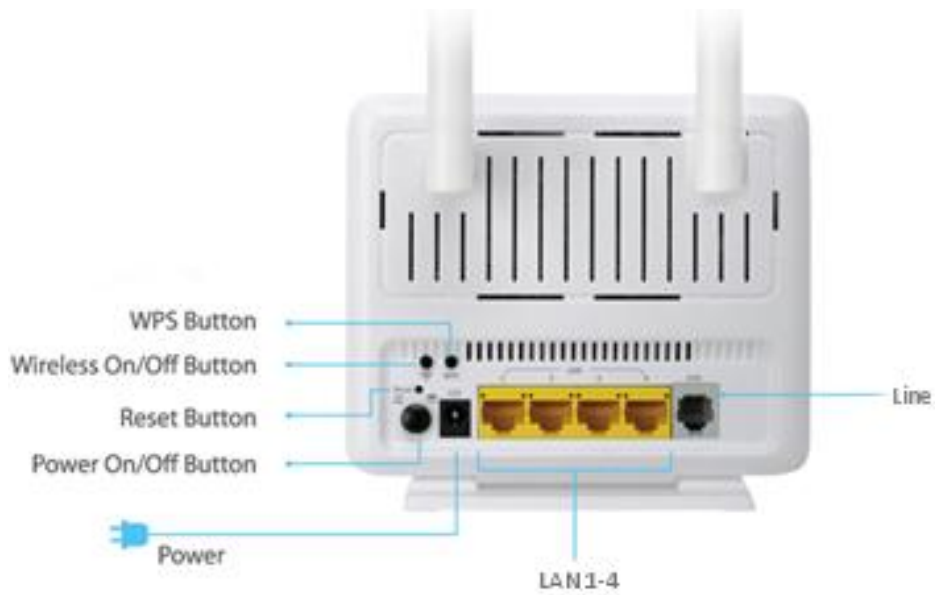
Rear Panel



Item	Description
Power On/Off Button 	Switches the router on or off.
Power	Power port for included 12V power adapter.
Wireless On/Off Button 	Switch the wireless signal on or off.
WPS Button	Activate WPS (Wi-Fi Protected Setup)
LAN 1–4	RJ-45 Ethernet ports 1–4.
Reset Button	Hold for less than 5 seconds to restart the device, and hold for more than 10 seconds to reset the device to factory default settings.
Line	RJ-11 port for standard telephone line.

1.5. Features

The device supports the following features:

- Various line modes
- External PPPoE dial-up access
- Internal PPPoE/PPPoA dial-up access
- 1483Bridged/1483Routed with dynamic ip or static ip
- Multiple PVCs (8 PVCs supported)
- DHCP server/relay
- Static route
- Network Address Translation(NAT)
- DMZ
- Virtual Server
- Universal plug and play (UPnP)
- Dynamic Domain Name Server(DDNS)
- One-level password and username
- Network Time Protocol(NTP)
- Firmware upgrading through Web, TFTP, or FTP
- Resetting to factory defaults through Reset button or Web
- Diagnostic test
- Web interface
- Telnet CLI
- IP/MAC/URL Filter
- Application layer service
- QOS
- Port binding

2. Hardware Installation

1. Connect the ADSL line.

Connect the line port of the router of the device to the modem interface of a splitter using a telephone cable. Connect a telephone to the Phone interface of the splitter using a telephone cable. Connect the Line interface of the splitter to your existing, incoming line.

The splitter has three interfaces:

- Line: Connect to a wall phone jack (RJ-11 jack).
- Modem: Connect to the ADSL jack of the device.
- Phone: Connect to a telephone set.

2. Connect the router to your LAN network.

Connect the LAN interface of the router to your PC, hub or switch using an Ethernet cable.

Note:

Use twisted-pair Ethernet cables to connect the router to a hub or switch.



3. Connect the power adapter to the router.

Plug one end of the power adapter into a wall outlet and connect the other end to the 12V interface of the device.

The following diagrams show how to correctly connect the router, PC, splitter and the telephone sets under two different configurations:



Configuration 1

0 shows the correct connection of the router, PC, splitter and the telephone sets, with no telephone set placed before the splitter.

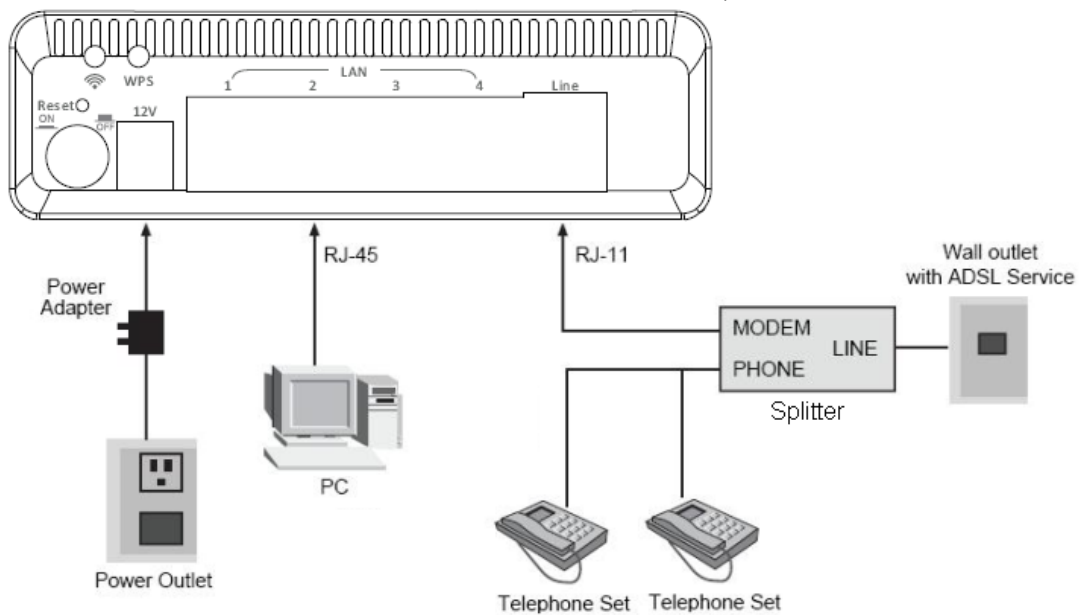

Figure 1 –Connection diagram
(Without connecting telephone sets before the splitter)

Configuration 2

0 shows the correct connection when a telephone set is installed before the splitter.

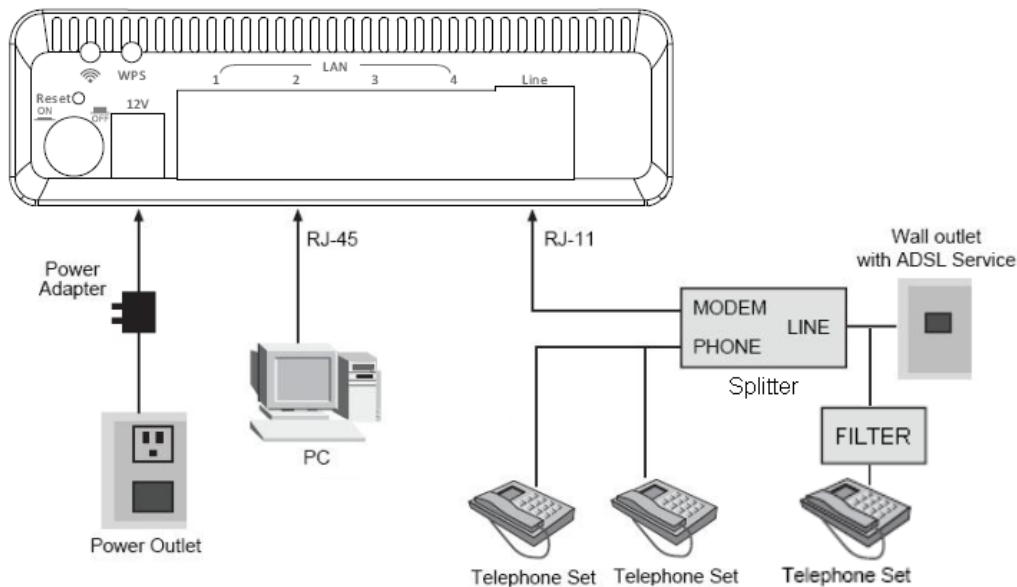

Figure 2 - Connection diagram
(Connecting a telephone set before the splitter)

Note:

When **Configuration 2** is used, the filter must be installed close to the telephone cable. Do not use the splitter to replace the filter.

Installing a telephone directly before the splitter may lead to failure of connection between the device and the central office, or failure of Internet access, or slow connection speed. If you really need to add a telephone set before the splitter, you must add a micro filter before a telephone set. Do not connect several telephones before the splitter or connect several telephones with the micro filter.

4. Check the ADSL LED status.

Please check the ADSL LED on the front panel. This light indicates the status of your ADSL broadband through your telephone line. If the light is on, you can continue setup. However if the light is flashing, there is no broadband line detected. Please call your Internet Service Provider (ISP) and inform them about the flashing ADSL light to resolve the issue.

5. Firewall settings.

Please turn off all personal firewalls before you continue the setup – firewalls can block communication between your PC and router.

Note: You must use the power adapter included in the package with the router, do NOT attempt to use a third-party power adapter.

6. PC LAN IP configuration.

Configure your PC's LAN settings to automatically obtain an IP address from the router by following the steps below:

1. Click **“Start”** and then select **“Control Panel”**.



2. Click **“Switch to Classic View”** in the top left to show additional setting icons.

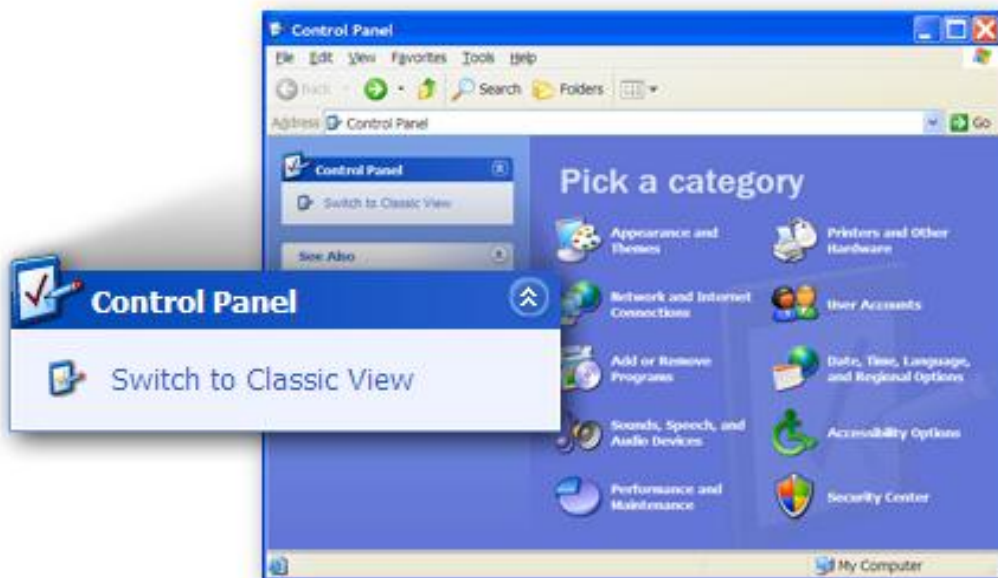

3. Locate the **“Network Connections”** icon and double-click to open network connection settings.



4. Select the **“Local Area Connection”** icon and right-click it to open the sub-menu, then select **“Properties”**.

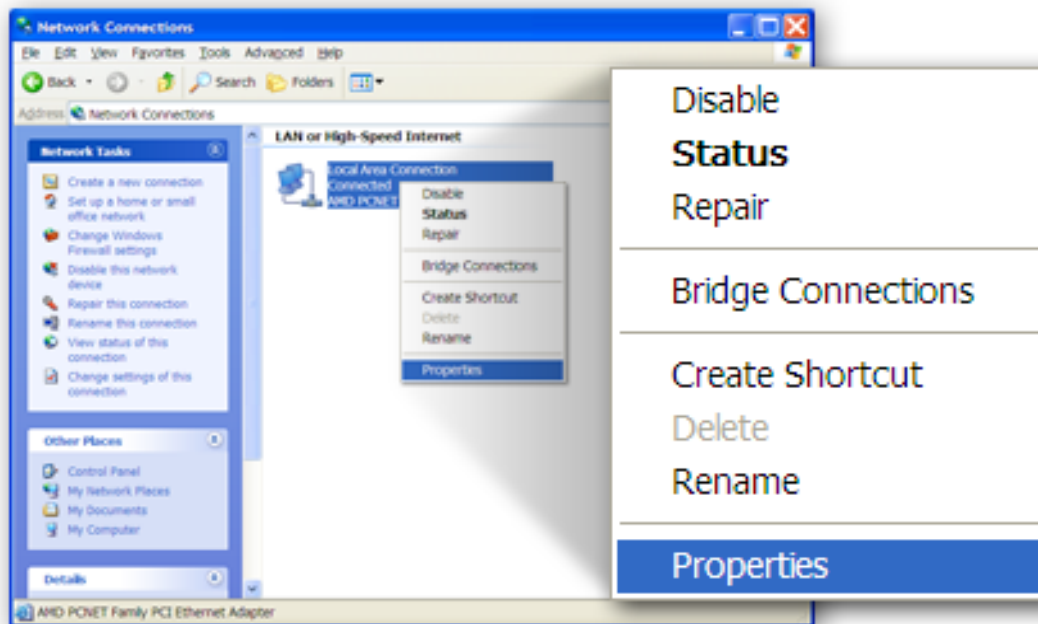

5. Select **“Internet Protocol (TCP/IP)”** and then click **“Properties”**

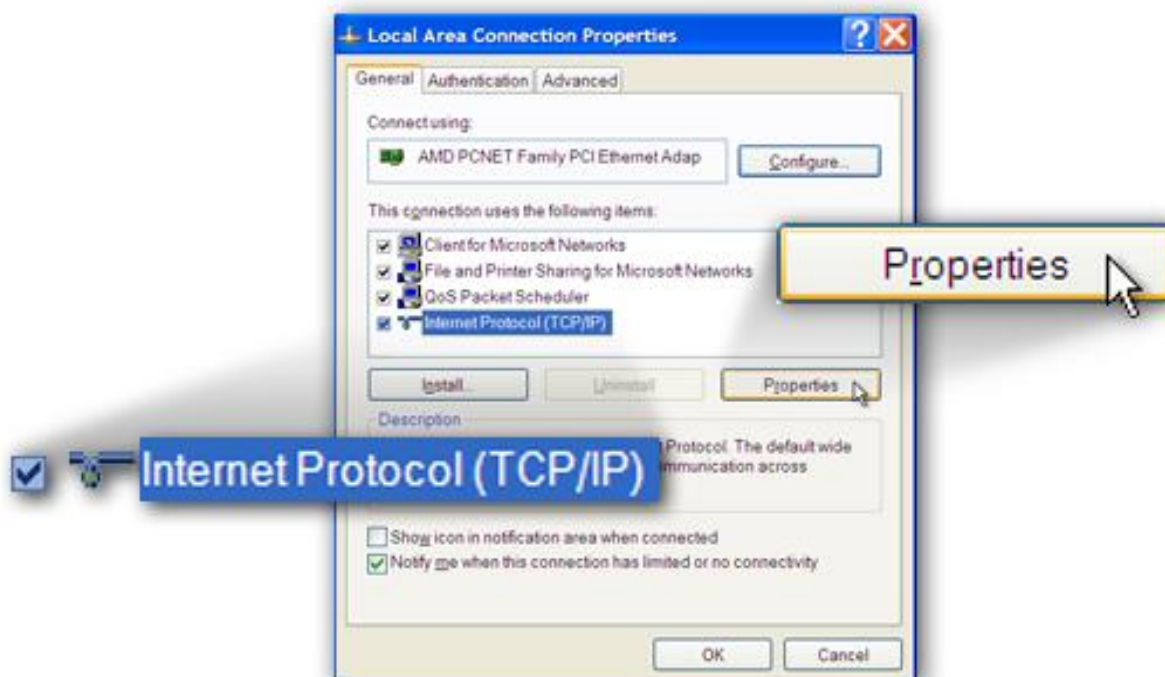

6. Ensure that **“Obtain an IP address automatically”** and **“Obtain DNS server address automatically”** are selected and then press **“OK”**.

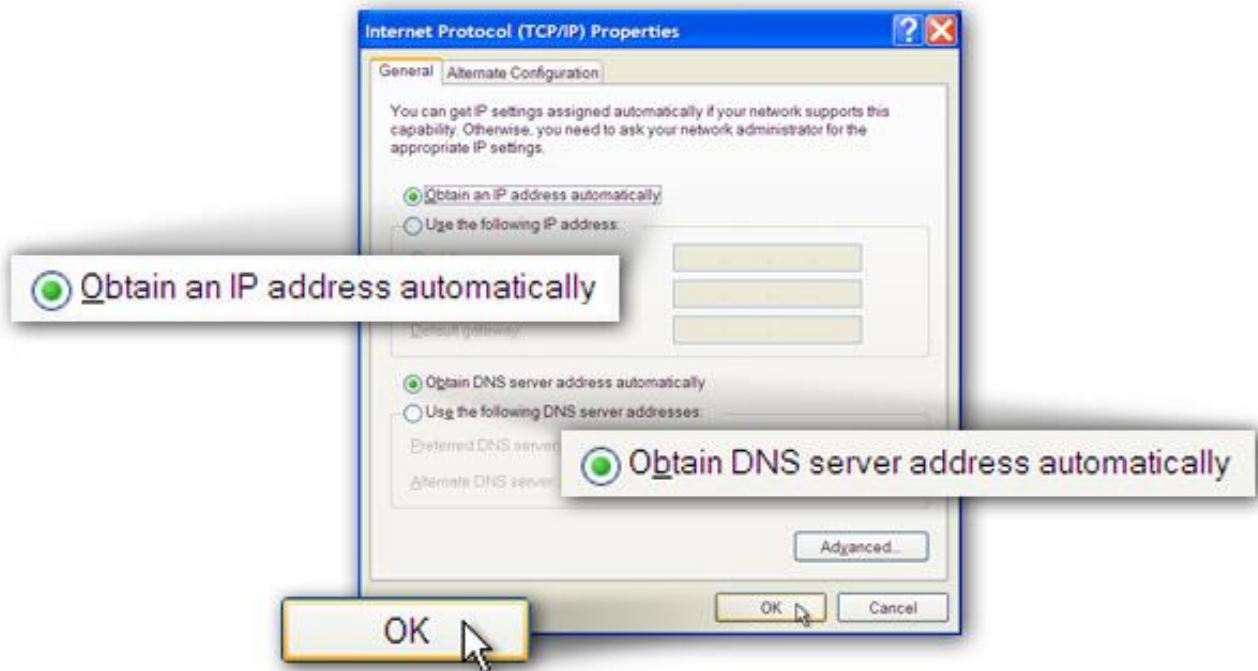

3. IP Address Setting

To use the router to access the Internet, the PCs in the network must have an Ethernet adapter installed and be connected to the router either directly or through a hub or switch. The TCP/IP protocol of each PC must be installed and the IP Address of each PC has to be set in the same subnet as the router.

The router's default IP Address is **192.168.2.1** and the subnet mask is **255.255.255.0**. PCs can be configured to obtain IP Address automatically through the DHCP Server of the router or a fixed IP Address in order to be in the same subnet as the router. By default, the DHCP Server of the router is enabled and will dispatch IP Address to PC from **192.168.2.100** to **192.168.2.200**. It is strongly recommended to set obtaining IP address automatically.

This section shows you how to configure your PC so that it can obtain an IP address automatically for either Windows 95/98/Me, 2000 or NT operating systems. For other operating systems (Macintosh, Sun, etc.), please follow the manual of the operating system. The following is a step-by-step illustration of how to configure your PC to obtain an IP address automatically for **Windows 8, Windows 7, Windows Vista and Windows XP**.

3.1. Windows 8

1. From the Windows 8 Start screen, you need to switch to desktop mode. Click the Desktop icon in the bottom left of the screen.

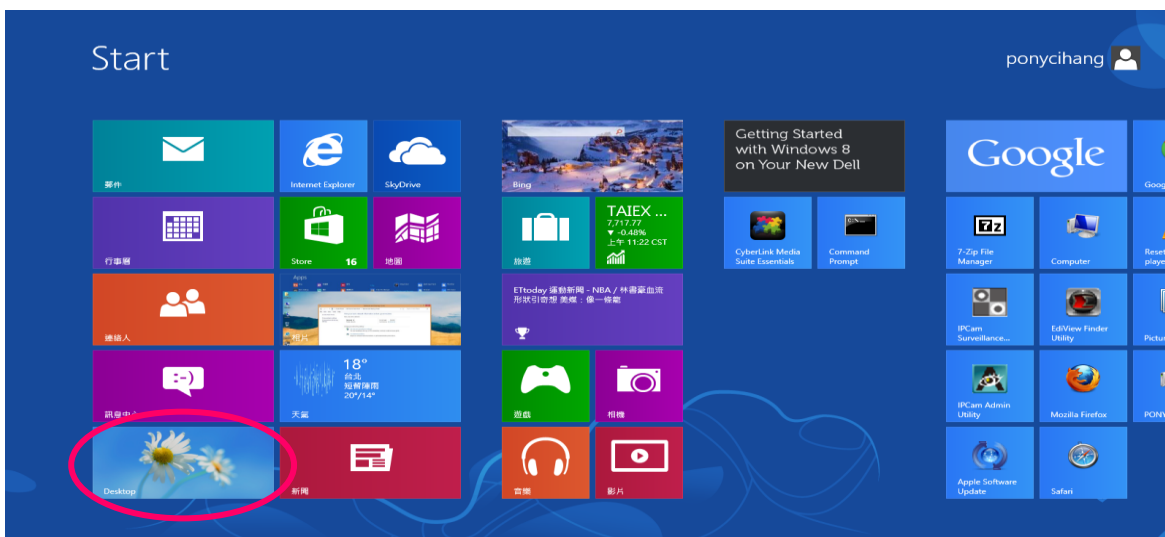

2. Click the Network icon  and then select Open Network and Sharing Center to open the Network and Sharing Center window.

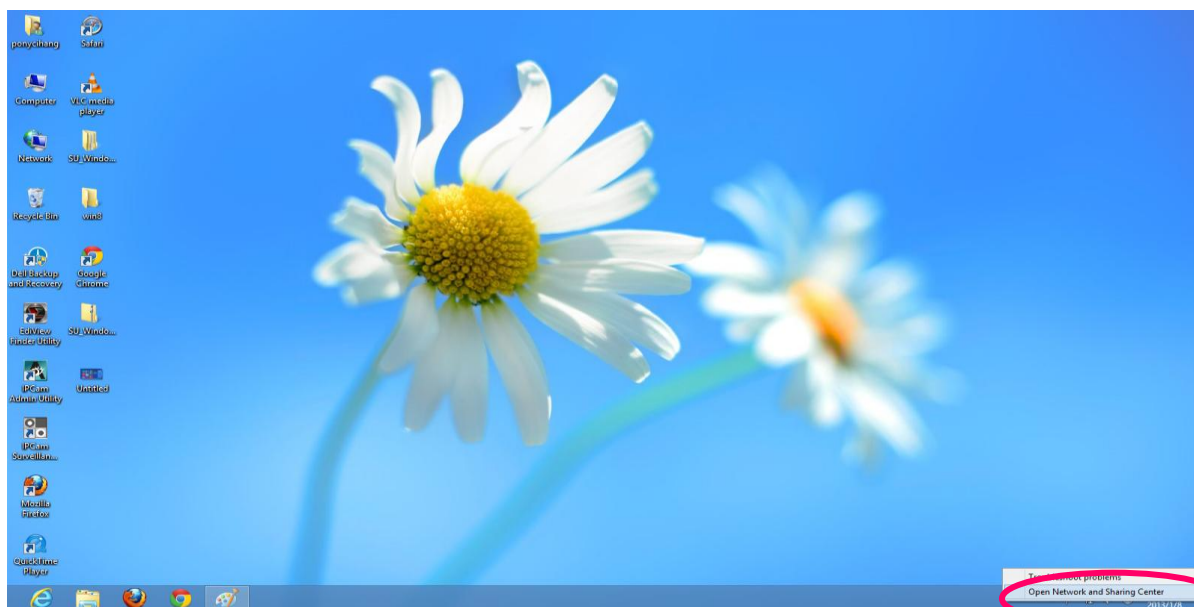

3. Click Ethernet to open the Ethernet Status window, and then select Properties. The Local Area Connection window will appear.

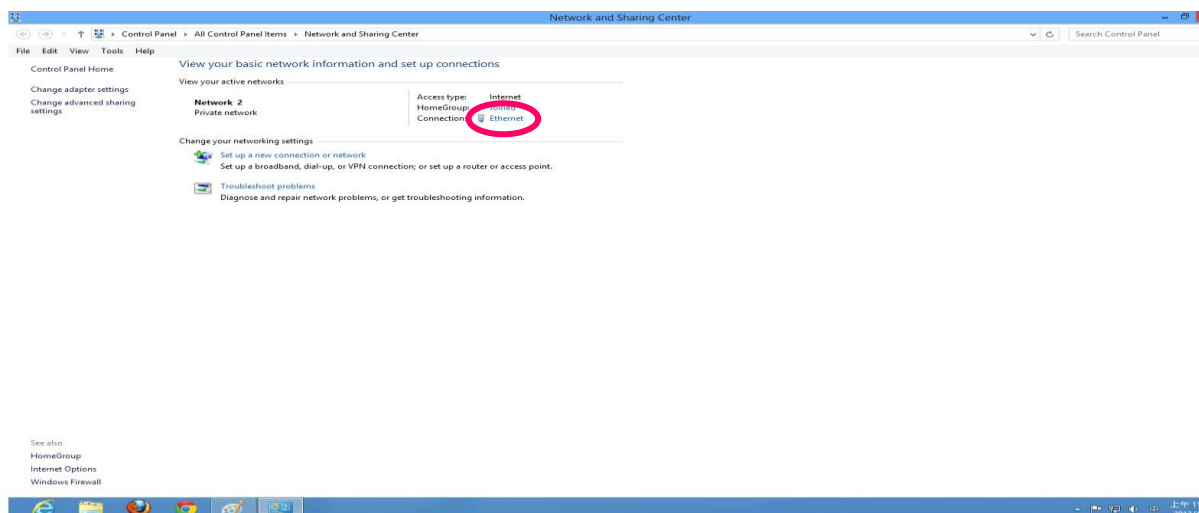

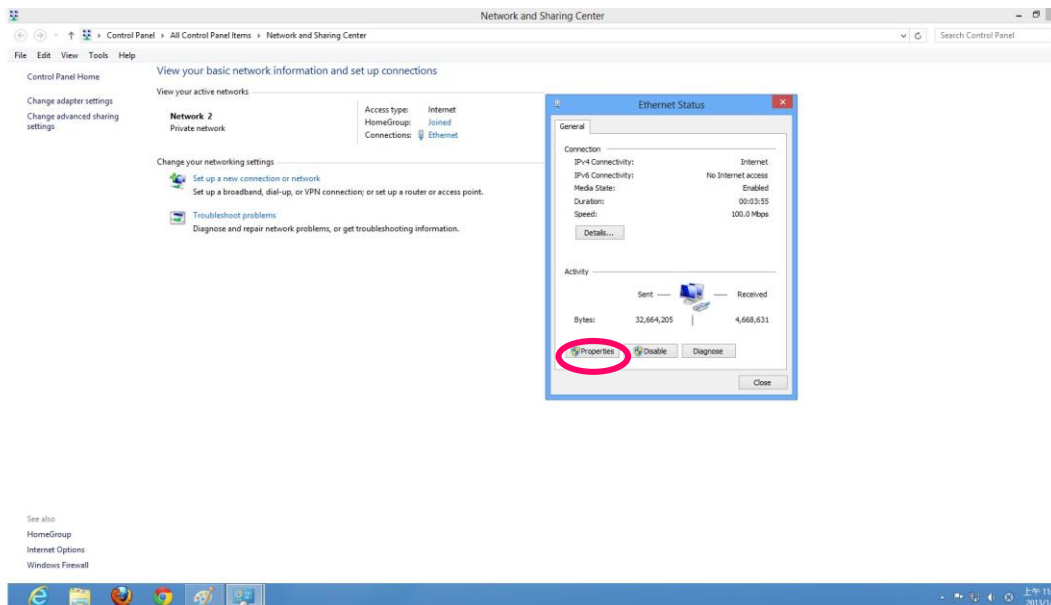

4. Check your list of Network Components. Select Internet Protocol Version 4 (TCP/IPv4) and click the Properties button.

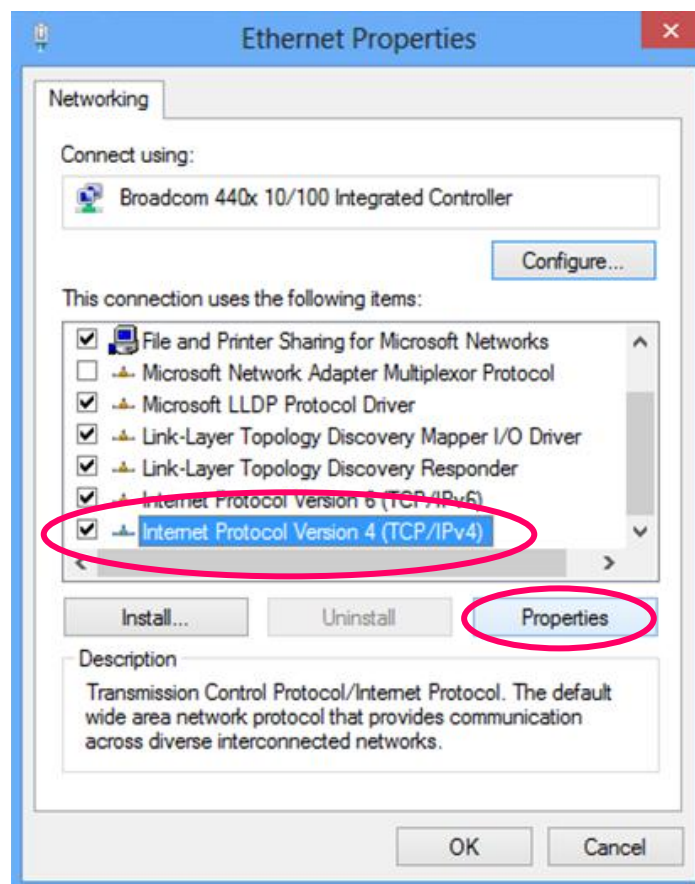

5. In the Internet Protocol Version 4 (TCP/IPv4) Properties window, select Obtain an IP address automatically and Obtain DNS server address automatically as shown on the following screen.

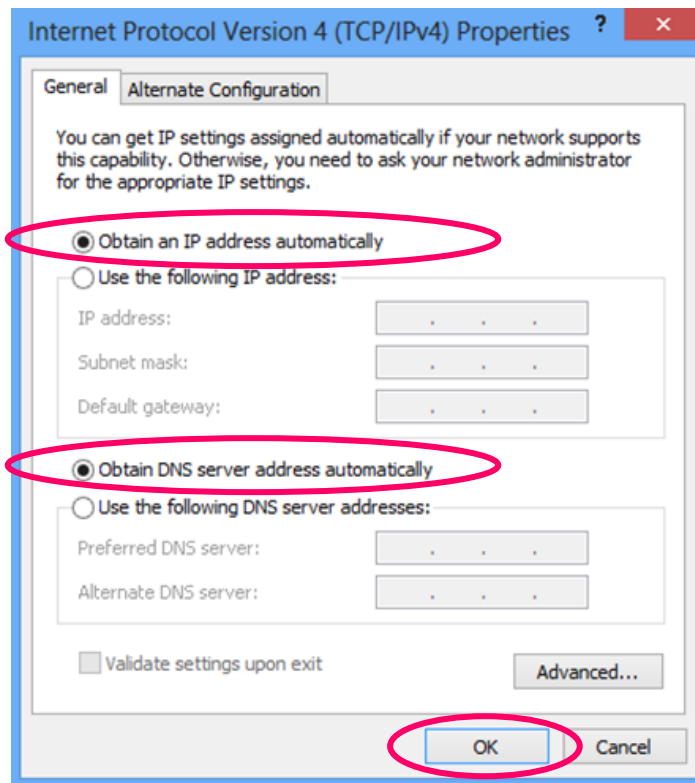

6. Click OK (shown above) to confirm the setting. Your PC will now obtain an IP address automatically from your router's DHCP server.

Note: Please make sure that the router's DHCP server is the only DHCP server available on your LAN.

3.2. Windows 7

1. Click the Start button and select Control Panel. Double click Network and Internet and click Network and Sharing Center, the Network and Sharing Center window will appear.
2. Click Change adapter settings and right click on the Local Area Connection icon and select Properties. The Local Area Connection window will appear.
3. Check your list of Network Components. You should see Internet Protocol Version 4 (TCP/IPv4) on your list. Select it and click the Properties button.

4. In the Internet Protocol Version 4 (TCP/IPv4) Properties window, select Obtain an IP address automatically and Obtain DNS server address automatically as shown on the following screen.

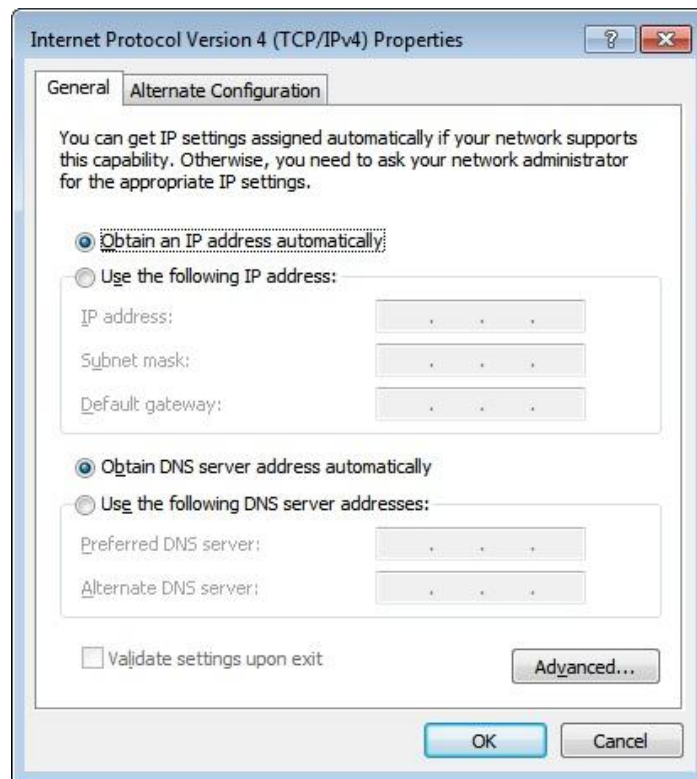

5. Click OK to confirm the setting. Your PC will now obtain an IP address automatically from your router's DHCP server.

Note: Please make sure that the router's DHCP server is the only DHCP server available on your LAN.

3.3. Windows Vista

1. Click the Start button and select Settings and then select Control Panel. Double click Network and Sharing Center, the Network and Sharing Center window will appear.
2. Click Manage network connections and right click on the Local Area Connection icon and select Properties. The Local Area Connection window will appear.

3. Check your list of Network Components. You should see Internet Protocol Version 4 (TCP/IPv4) on your list. Select it and click the Properties button.
4. In the Internet Protocol Version 4 (TCP/IPv4) Properties window, select Obtain an IP address automatically and Obtain DNS server address automatically as shown on the following screen.

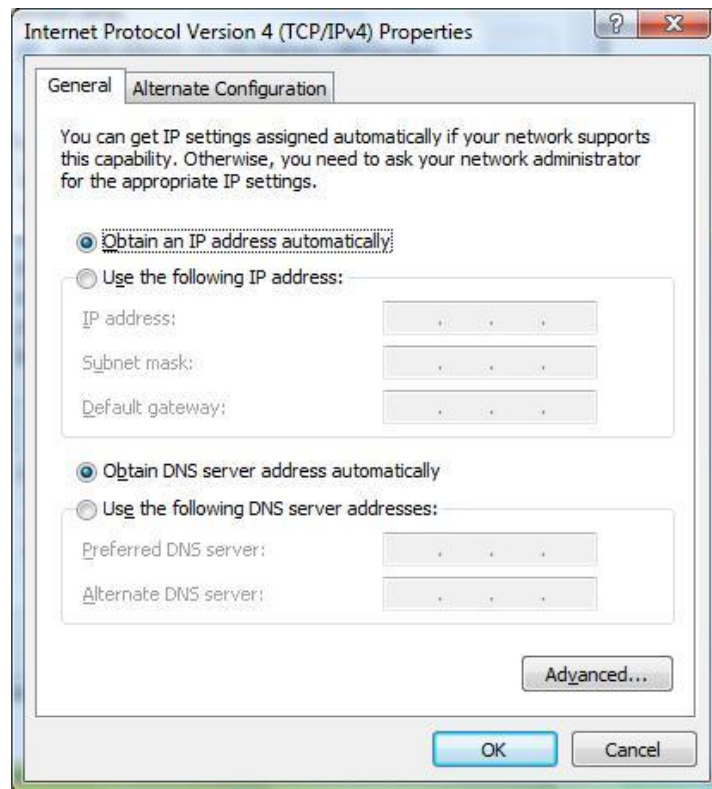

5. Click OK to confirm the setting. Your PC will now obtain an IP address automatically from your router's DHCP server.

Note: Please make sure that the router's DHCP server is the only DHCP server available on your LAN.

3.4. Windows XP

1. Click the Start button and select Control Panel and then double click Network Connections. The Network Connections window will appear.
2. Right click on the Local Area Connection icon and select Properties. The Local Area Connection window will appear.

3. Check your list of Network Components. You should see Internet Protocol [TCP/IP] on your list. Select it and click the Properties button.
4. In the Internet Protocol (TCP/IP) Properties window, select Obtain an IP address automatically and Obtain DNS server address automatically as shown on the following screen.

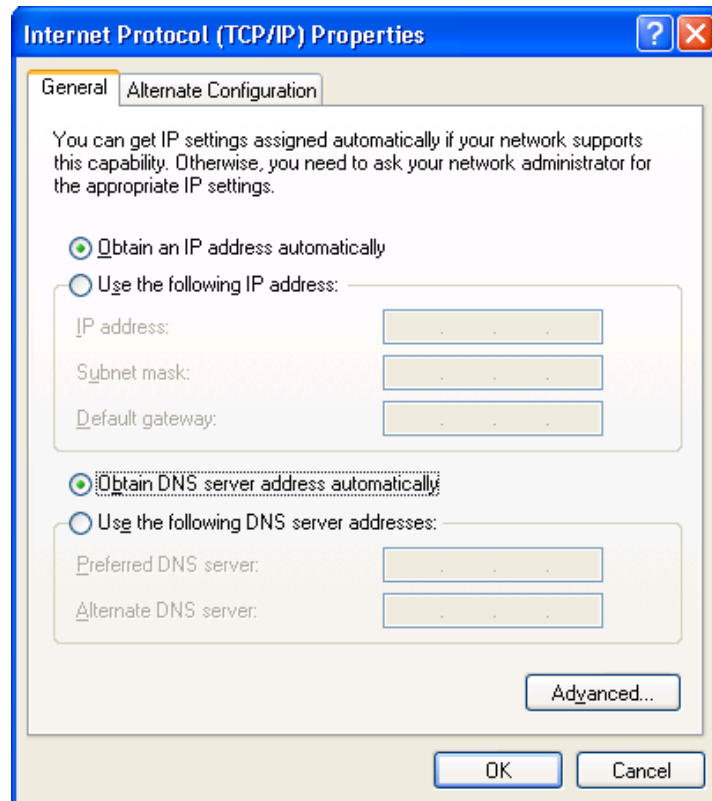

5. Click OK to confirm the setting. Your PC will now obtain an IP address automatically from your router's DHCP server.

Note: Please make sure that the router's DHCP server is the only DHCP server available on your LAN.

4. EZmax Setup Wizard

You can configure the router by running the setup wizard on the CD-ROM included in the package contents. The wizard enables you to configure your Internet connection, upgrade the firmware and change the router's password. Please follow the instructions below.

Alternatively, if you lose the CD-ROM or prefer a web based setup, you can login to the ADSL router using Internet Explorer, and configure the router from there using the web-based interface. Instructions for how to do so can be found in **5. Web Configuration**.

4.1. Setup Wizard

1. When you start the setup wizard, you will see the following screen. Please choose a language and follow the on screen instructions.

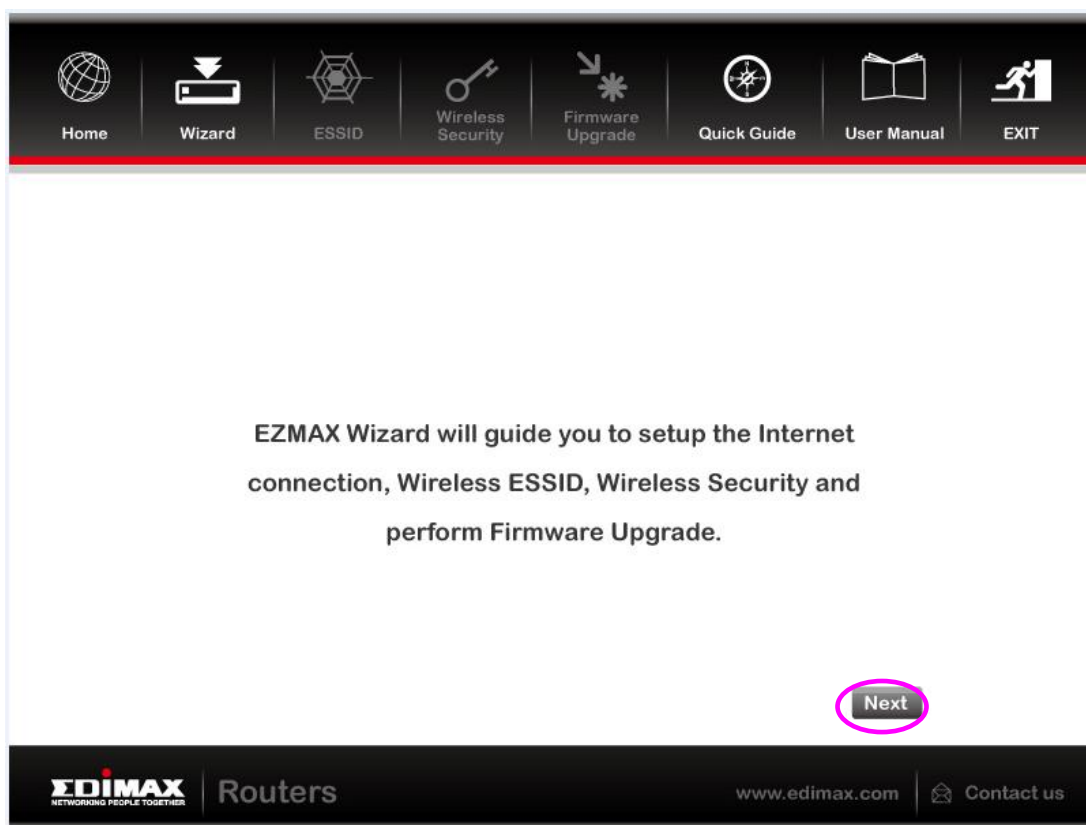

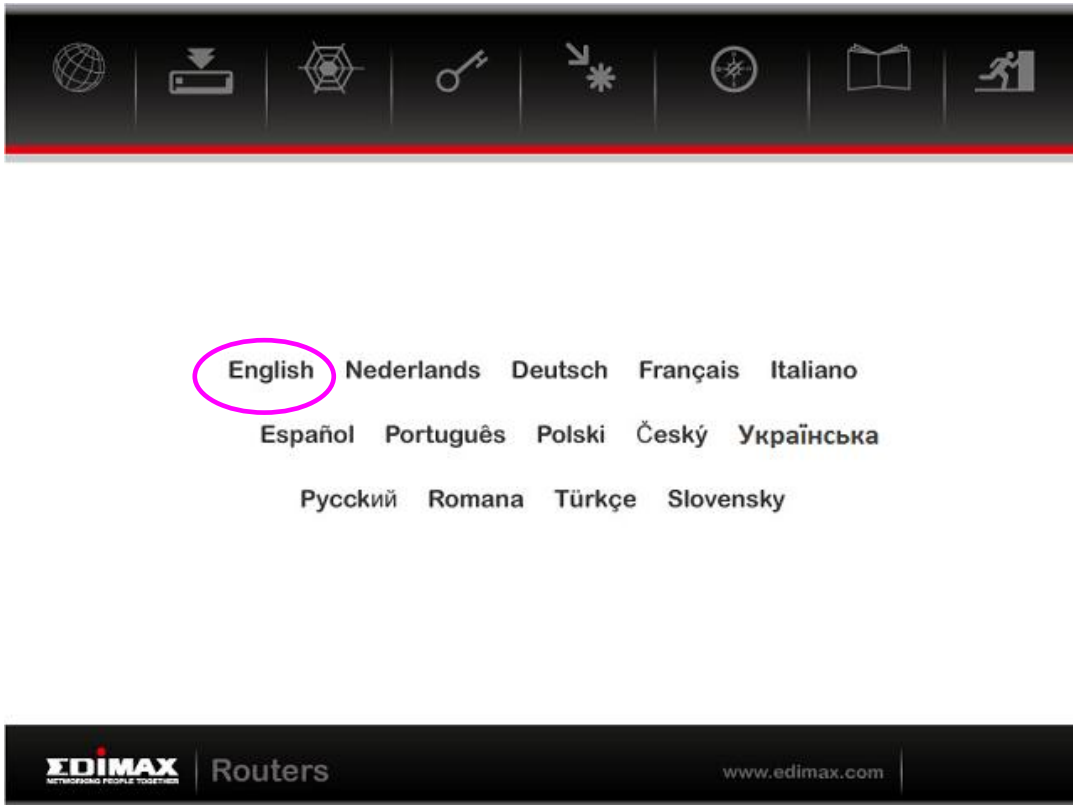

2. Please select your product.

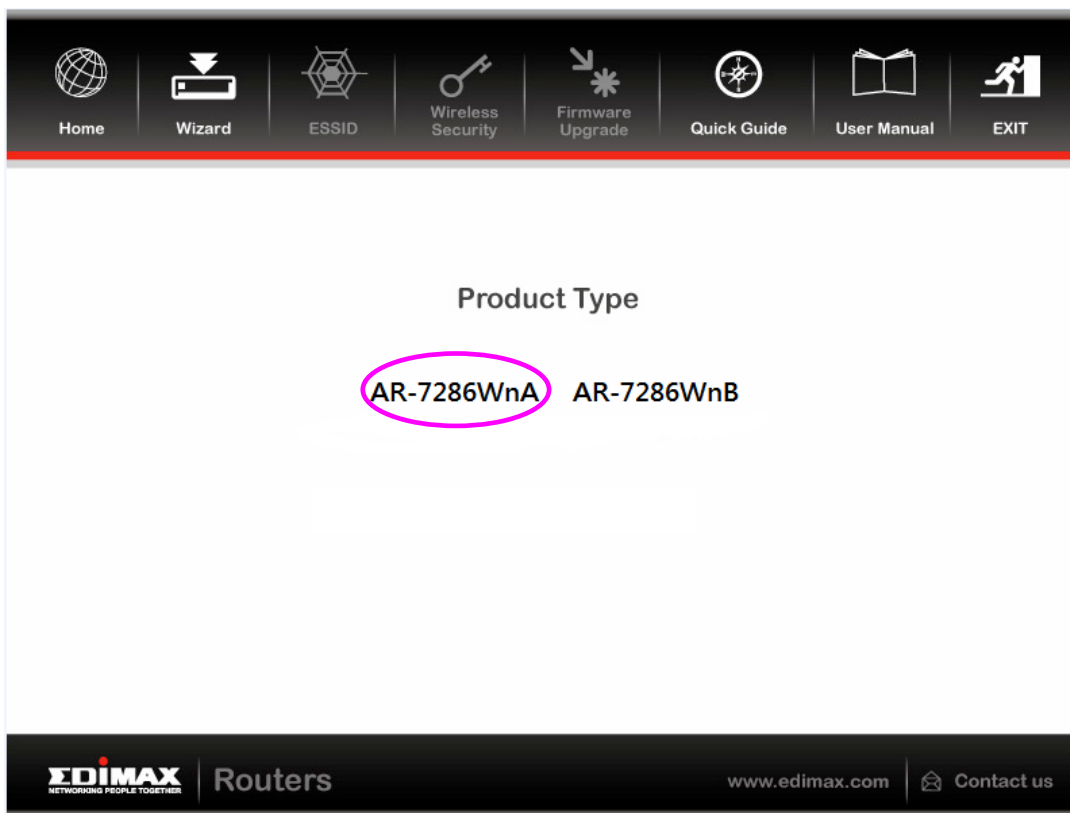

3. Please ensure all hardware is correctly installed. Check the box and click "Next".

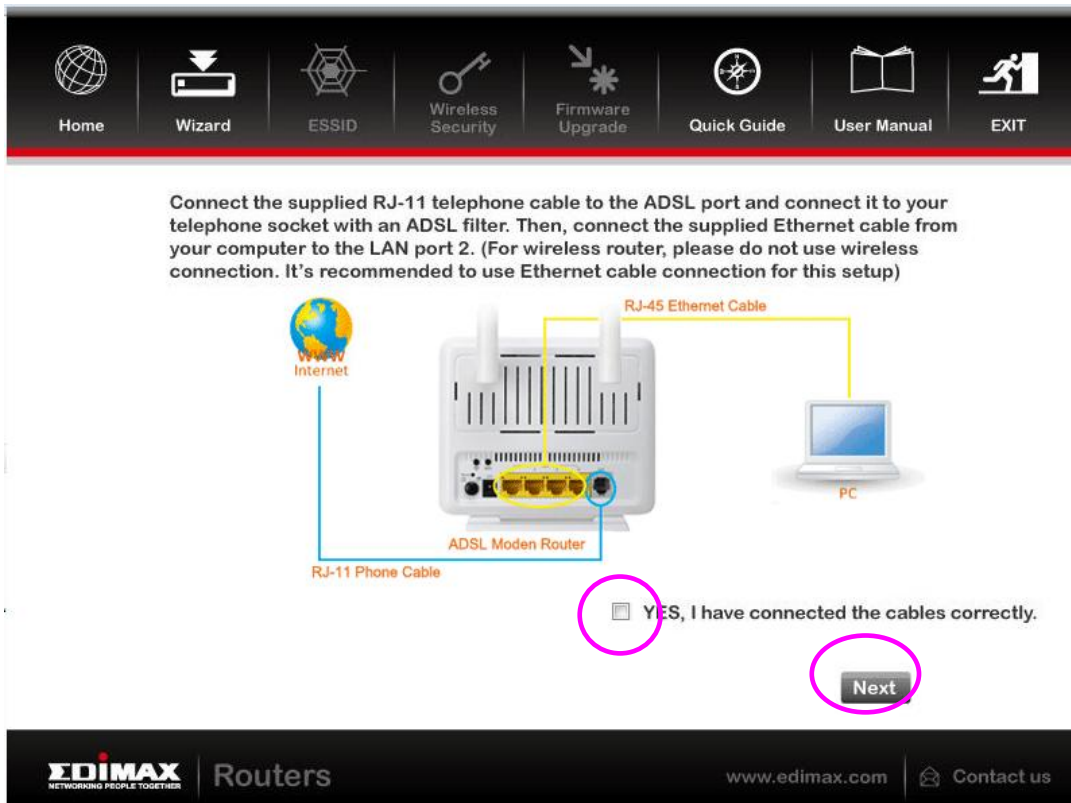
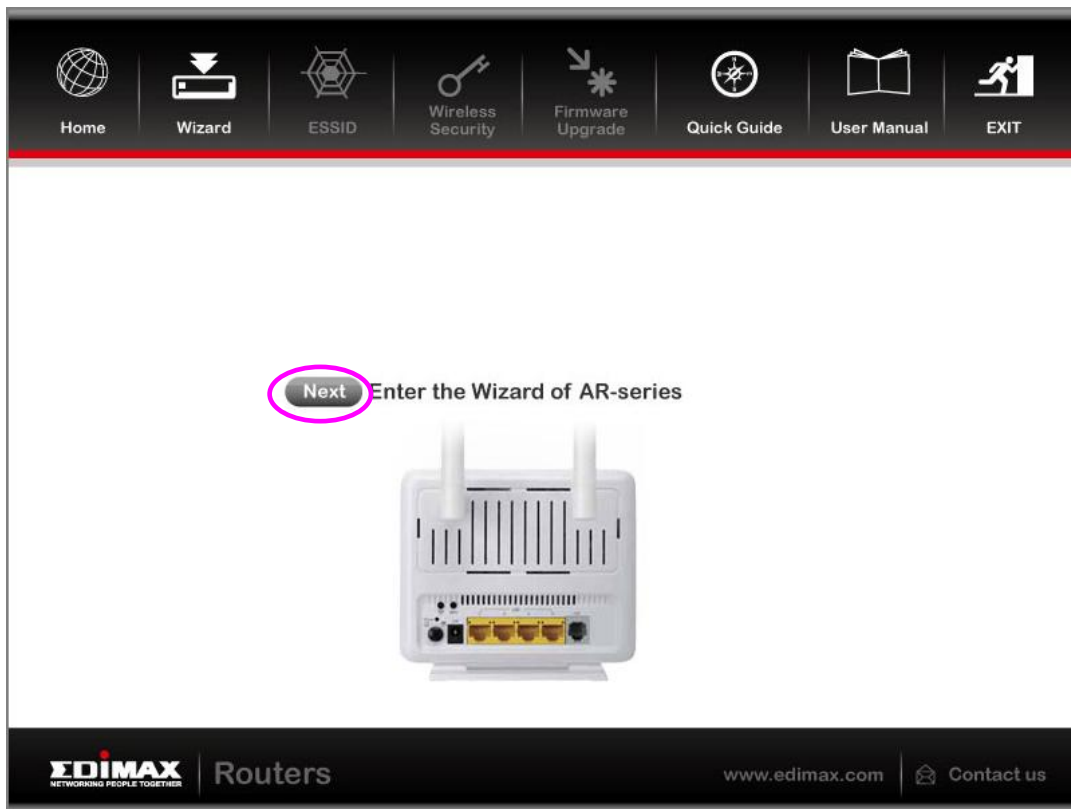

4. Select your country and ISP. If your ISP is not listed, select “Other” from the list and refer to **4.2. Internet Connection Type**.

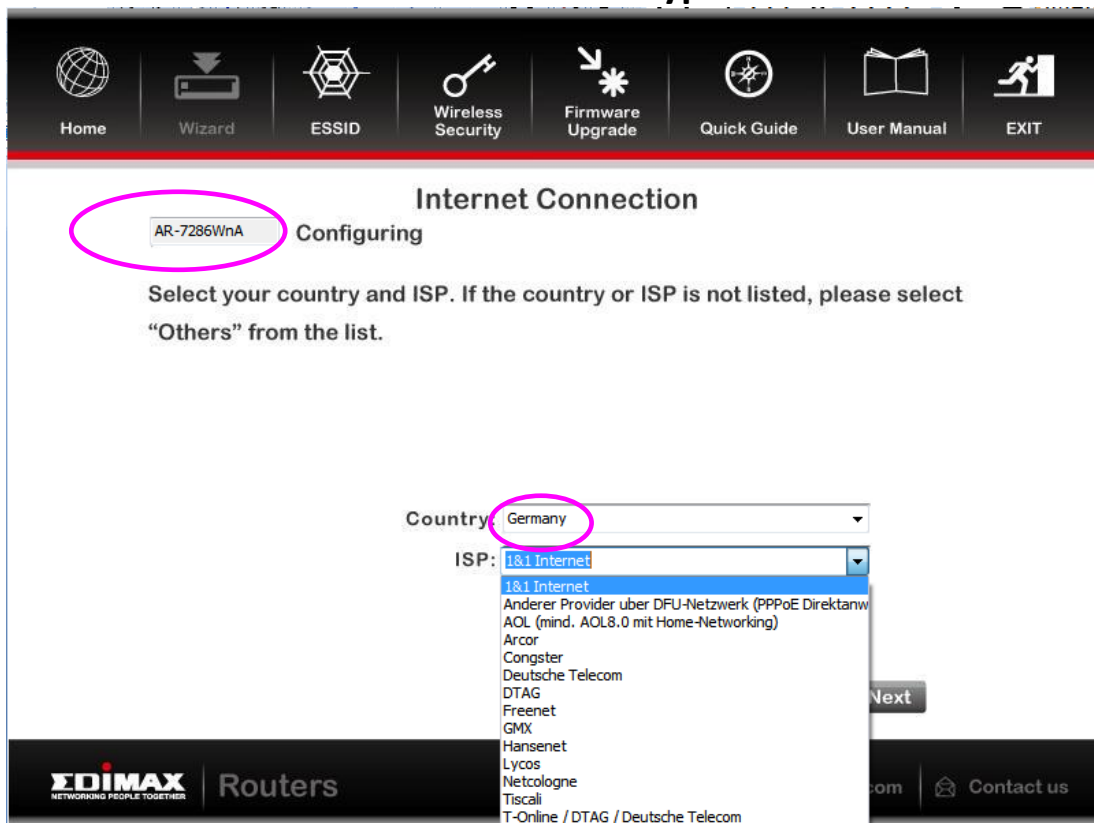

5. Enter your ISP’s username and password and click “Apply”. On the next screen, click “Apply” again.

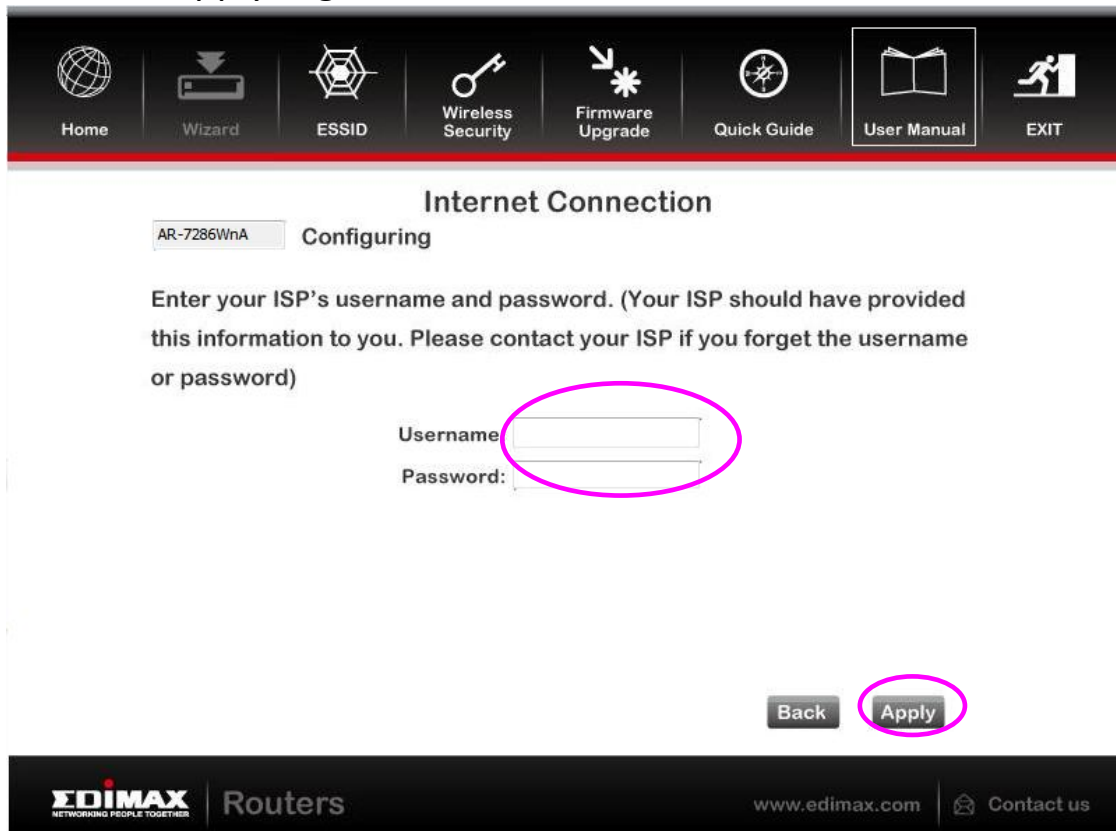

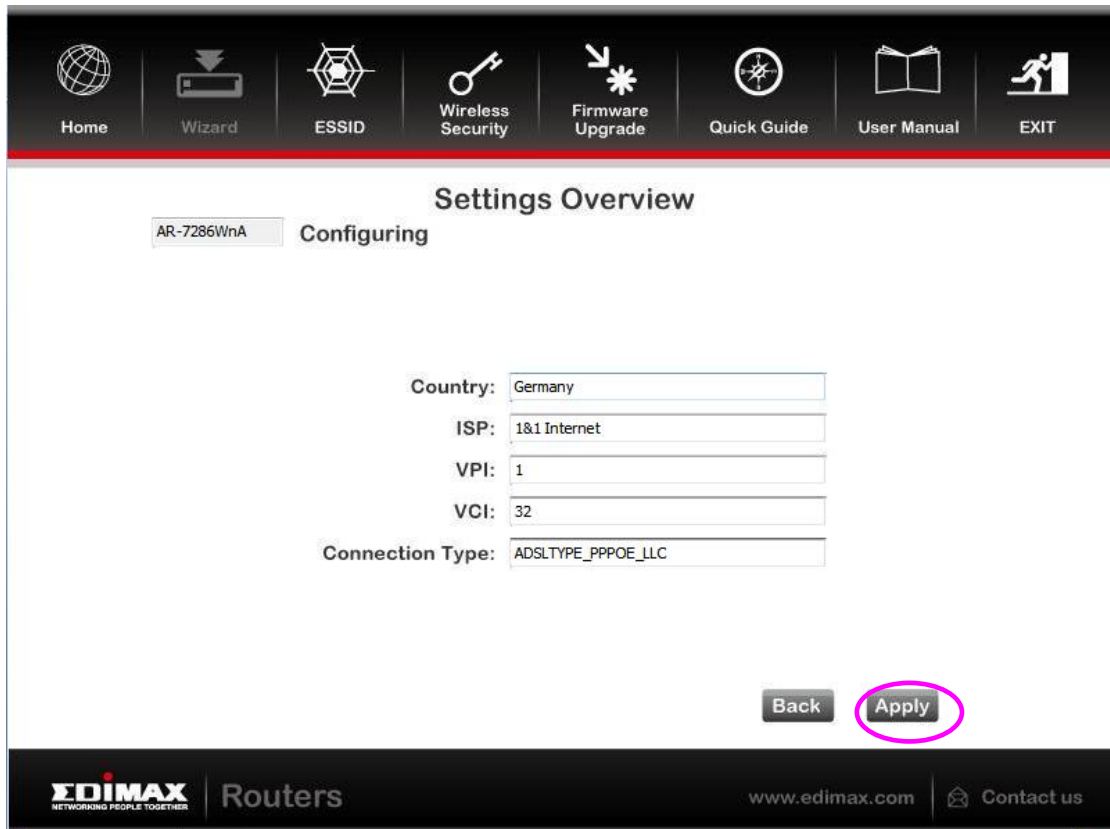

6. Please wait while the router connects to the Internet. When the router is connected successfully, you will see the screen below.

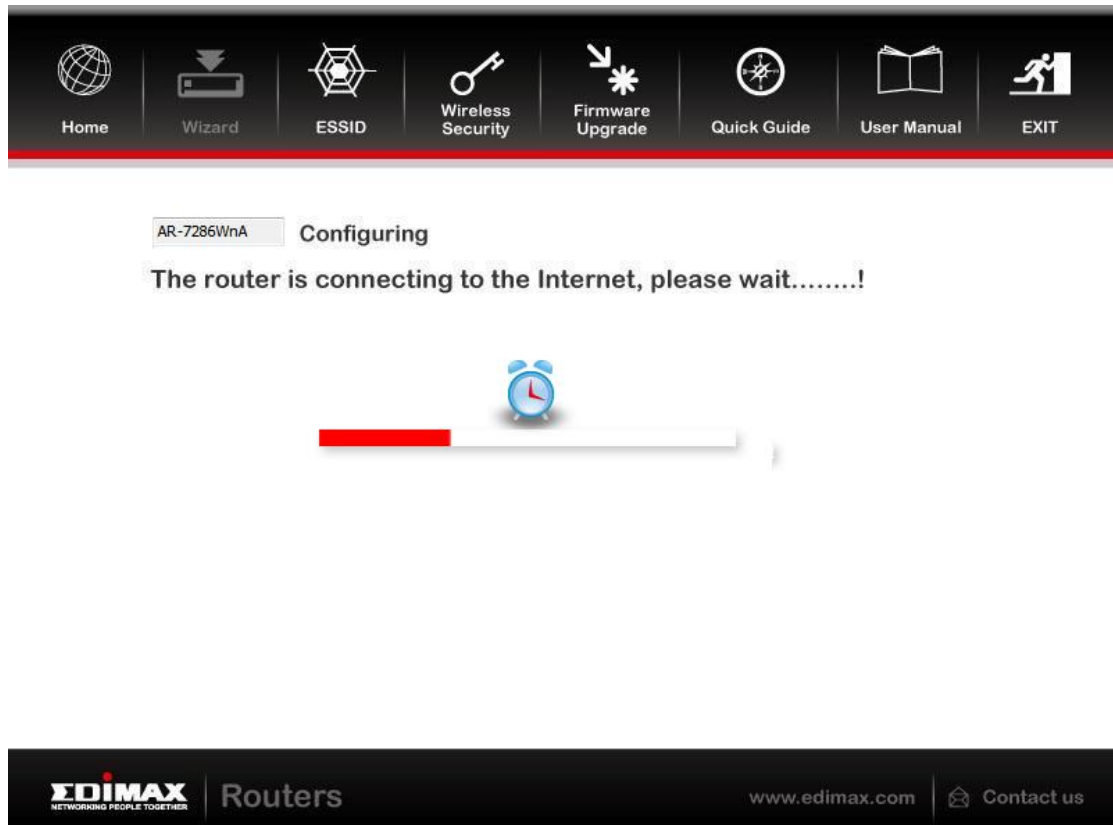

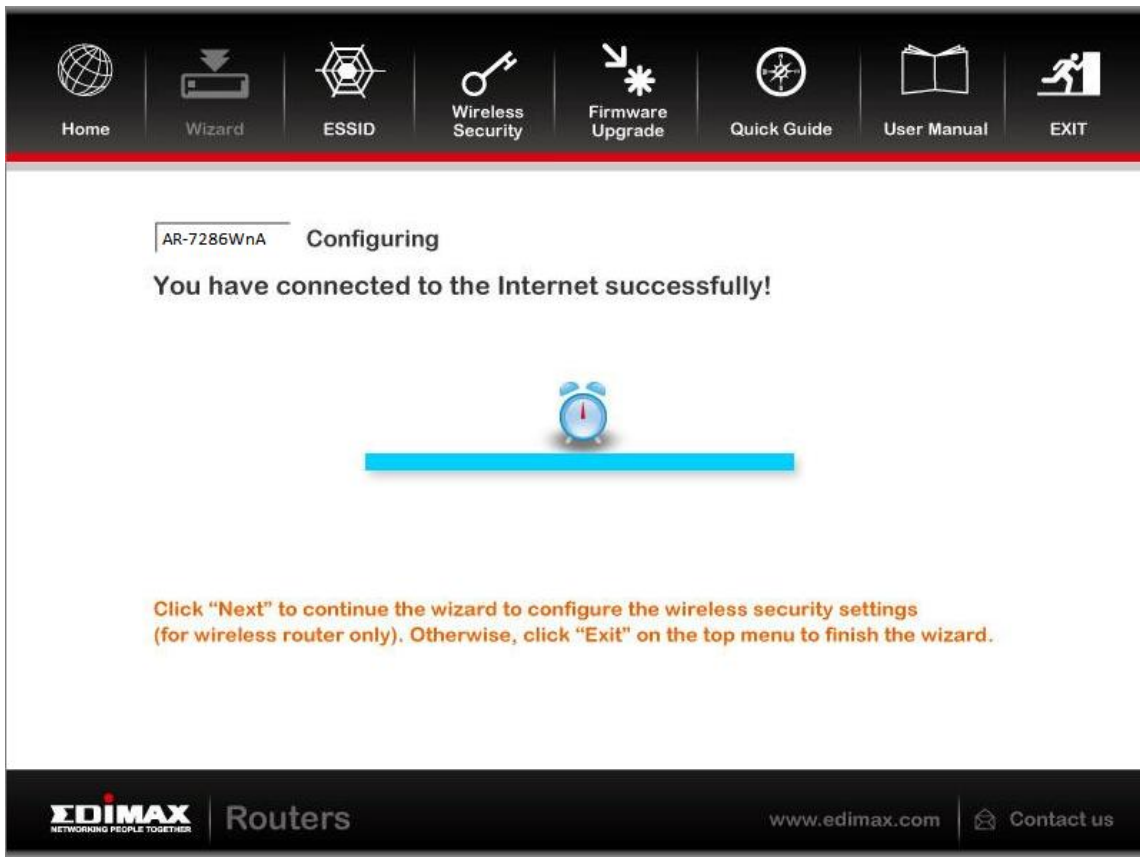

4.2. Internet Connection Type

If your country or ISP is not listed, please select "Other" from the list.

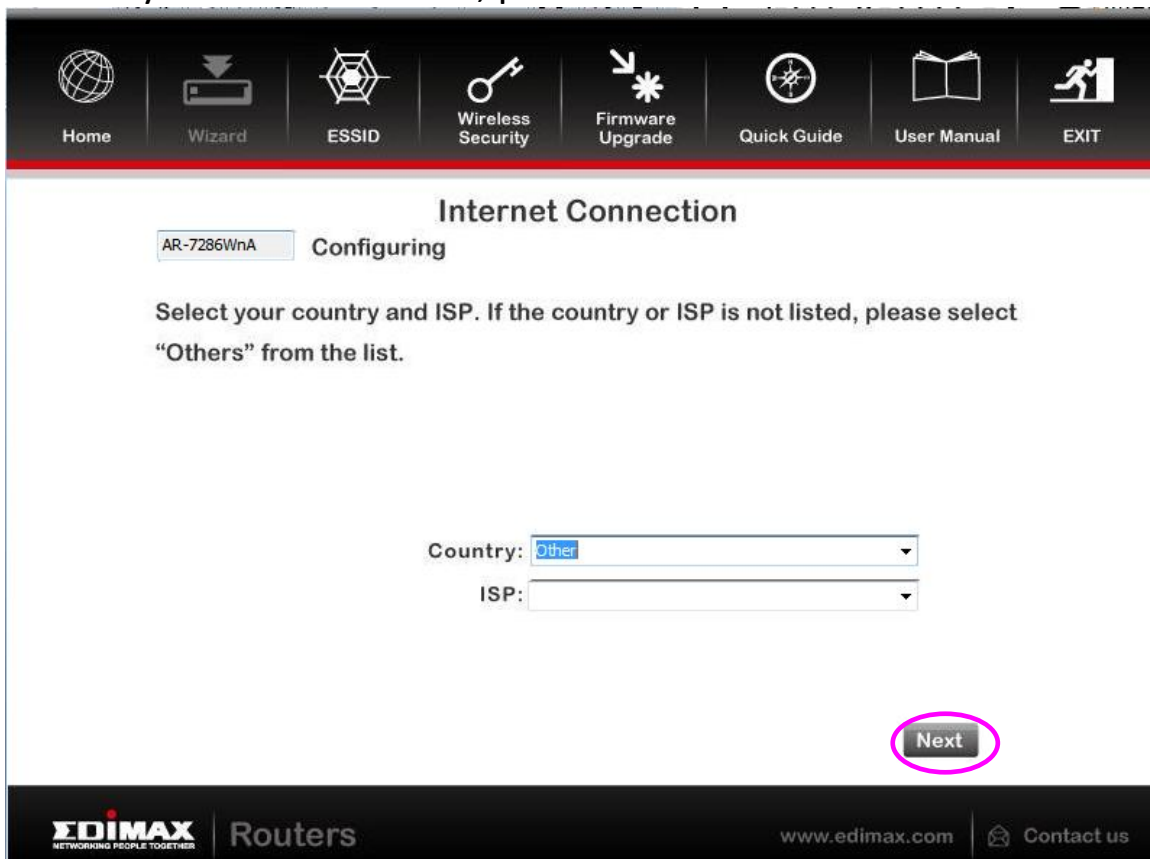

Then select your Internet connection type and click “Next”. If you are not sure, please contact your Internet Service Provider (ISP).

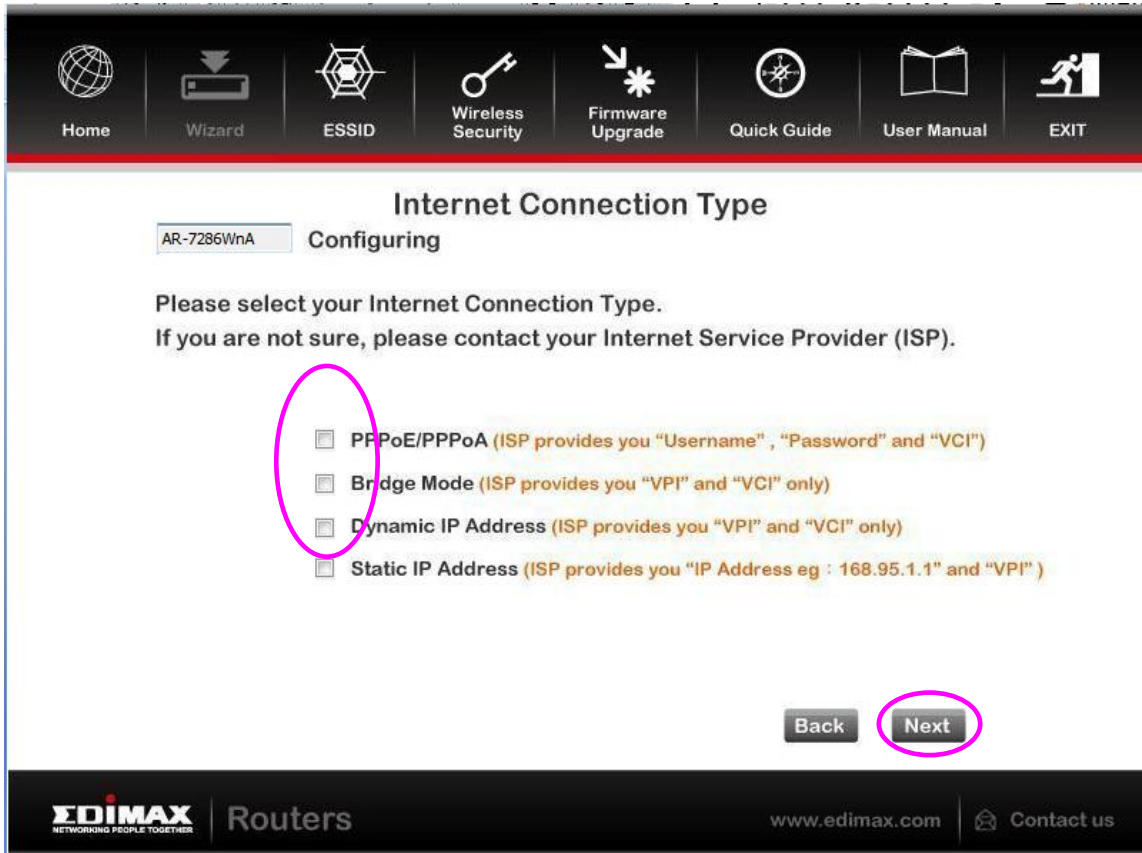

Depending on your selection, please refer to the appropriate chapter:

4.2.1. PPPoE/PPPoA

4.2.2. Bridge Mode

4.2.3. Dynamic IP Address

4.2.4. Static IP

Parameter	Description
PPPoE/PPPoA	PPPoE (PPP over Ethernet) and PPPoA (PPP over ATM) are common connection methods used for xDSL.
Bridge Mode	Bridge Mode is a common connection method used for xDSL modems.
Dynamic IP Address	Obtain an IP address automatically from your service provider.

Static IP Address Uses a static IP address. Your service provider gives a static IP address to access Internet services.

4.2.1. PPOE/PPPoA

Home Wizard ESSID Wireless Security Firmware Upgrade Quick Guide User Manual EXIT

PPPoE/PPPoA

AR-7286WnA Configuring

Enter your ISP's username and password. (Your ISP should have provided this information to you. Please contact your ISP if you forget the username or password)

User Name:

Password:

VPI: (0~255)

VCI: (32~65535)

Connection Type:

Back Apply

EDIMAX NETWORKING PEOPLE TOGETHER Routers www.edimax.com Contact us

Parameter	Description
User Name	Enter the username exactly as your ISP assigned.
Password	Enter the password that your ISP has assigned to you.
VPI	Virtual path identifier (VPI) is the virtual path between two points in an ATM network. Its valid value is in the range of 0 to 255. Enter the correct VPI provided by your ISP. By default, VPI is set to 8.
VCI	Virtual channel identifier (VCI) is the virtual channel

between two points in an ATM network. Its valid value is in the range of 32 to 65535 (0 to 31 is reserved for local management of ATM traffic). Enter the correct VCI provided by your ISP. By default, VCI is set to 35.

Connection type Please check with your ISP the method of multiplexing. In PPPoE/PPPoA mode, please select “PPPoE LLC”, “PPPoE VCMUX”, “PPPoA LLC” or “PPPoA VCMUX”.

4.2.2. Bridge Mode

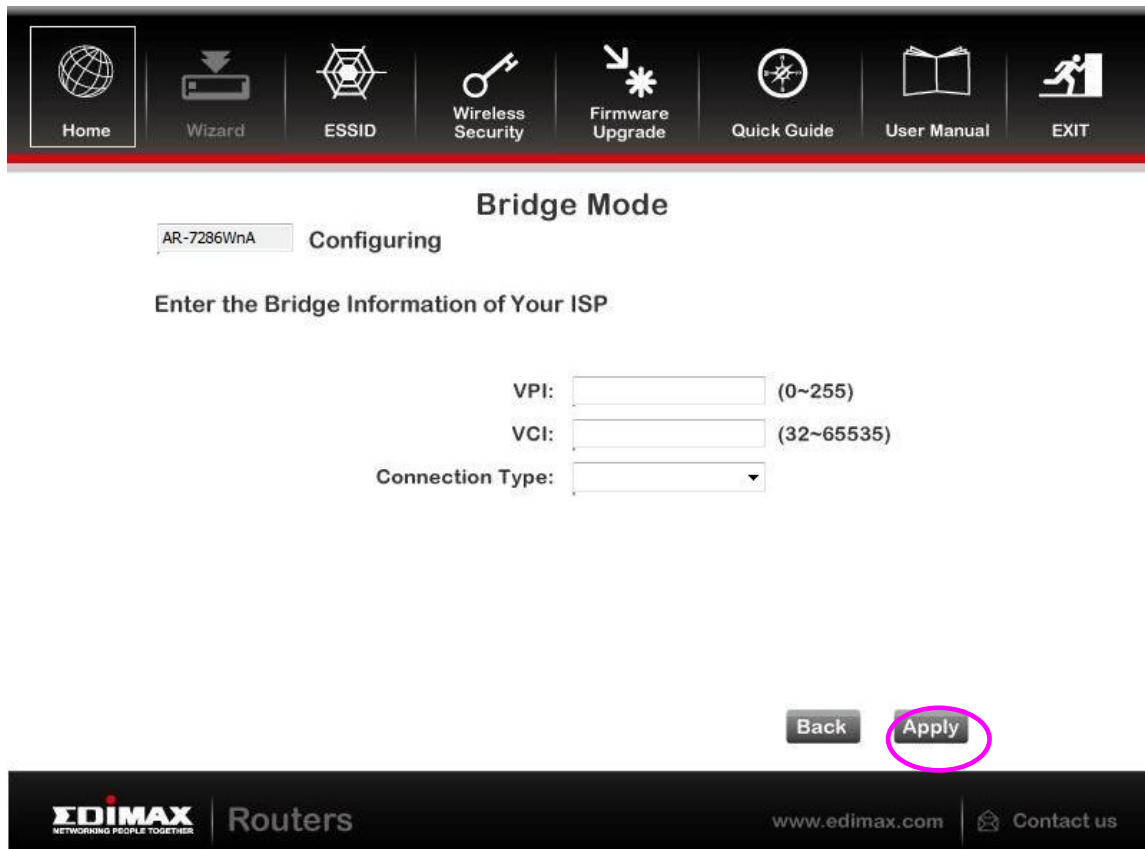

Parameter	Description
VPI	Virtual path identifier (VPI) is the virtual path between two points in an ATM network. Its valid value is in the range of 0 to 255. Enter the correct VPI provided by your ISP. By default, VPI is set to 8.

VCI

Virtual channel identifier (VCI) is the virtual channel between two points in an ATM network. Its valid value is in the range of 32 to 65535 (0 to 31 is reserved for local management of ATM traffic). Enter the correct VCI provided by your ISP. By default, VCI is set to 35.

Connection Type Please check with your ISP the method of multiplexing. In Bridge Mode, please select “ADSLTYPE_ROUTER_LLC” or “ADSLTYPE_ROUTER_VCMUX”.

4.2.3. Dynamic IP Address

The screenshot shows the 'Dynamic IP Address' configuration page on an Edimax router. At the top, there is a navigation bar with icons for Home, Wizard, ESSID, Wireless Security, Firmware Upgrade, Quick Guide, User Manual, and EXIT. Below the navigation bar, the page title is 'Dynamic IP Address' and the status is 'Configuring'. The device model 'AR-7286WnA' is displayed. The instruction reads: 'Enter the Dynamic Connection Information of Your ISP'. There are three input fields: 'VPI:' with a range of '(0~255)', 'VCI:' with a range of '(32~65535)', and 'Connection Type:' with a dropdown arrow. At the bottom right, there are two buttons: 'Back' and 'Apply', with the 'Apply' button circled in pink. The footer contains the Edimax logo with the tagline 'NETWORKING PEOPLE TOGETHER', the word 'Routers', the website 'www.edimax.com', and a 'Contact us' link.

Parameter	Description
VPI	Virtual path identifier (VPI) is the virtual path between two points in an ATM network. Its valid value is in the range of 0 to 255. Enter the correct VPI provided by your ISP. By

default, VPI is set to 8.

VCI

Virtual channel identifier (VCI) is the virtual channel between two points in an ATM network. Its valid value is in the range of 32 to 65535. (0 to 31 is reserved for local management of ATM traffic) Enter the correct VCI provided by your ISP. By default, VCI is set to 35.

Connection Type

Please check with your ISP the method of multiplexing. In Bridge Mode, please select “ADSLTYPE_ROUTER_LLC” or “ADSLTYPE_ROUTER_VCMUX”.

4.2.4. Static IP

The screenshot shows the 'Static IP' configuration page in the Edimax web interface. At the top, there is a navigation bar with icons for Home, Wizard, ESSID, Wireless Security, Firmware Upgrade, Quick Guide, User Manual, and EXIT. Below the navigation bar, the page title 'Static IP' is displayed. A breadcrumb trail shows 'AR-7286WnA' and 'Configuring'. The main heading is 'Enter the Static IP Address Information of Your ISP'. The form contains the following fields: VPI (range 0-255), VCI (range 32-65535), IP Address (three input boxes), Subnet mask (three input boxes), ISP Gateway (three input boxes), and Connection Type (a dropdown menu). At the bottom right, there are 'Back' and 'Apply' buttons, with the 'Apply' button circled in pink. The footer includes the Edimax logo, 'Routers', the website 'www.edimax.com', and a 'Contact us' link.

Parameter	Description
VPI	Virtual path identifier (VPI) is the virtual path between two points in an ATM network. Its

valid value is in the range of 0 to 255. Enter the correct VPI provided by your ISP. By default, VPI is set to 8.

VCI Virtual channel identifier (VCI) is the virtual channel between two points in an ATM network. Its valid value is in the range of 32 to 65535. (0 to 31 is reserved for local management of ATM traffic) Enter the correct VCI provided by your ISP. By default, VCI is set to 35.

Static IP Address Enter the IP Address assigned by your ISP.

IP Subnet Mask Enter the Subnet Mask assigned by your ISP.

Gateway Enter the Gateway assigned by your ISP.

Connection Type Please check with your ISP the method of multiplexing. In Bridge Mode, please select "ADSLTYPE_ROUTER_LLC" or "ADSLTYPE_ROUTER_VCMUX".

4.3. Firmware Upgrade

The wizard includes a tool to upgrade the router's firmware. Firmware can be downloaded from the Edimax website; if you wish to upload new firmware, select "Firmware Upgrade" from the menu across the top of the screen.

Firmware Upgrade

AR-7286WnA Configuring

To upgrade the firmware, please download the latest firmware from Edimax website. Save and unzip the firmware file to a directory in your computer. Click on "Browse" to browse to the firmware file. Then Click on "Confirm" to start the firmware upgrade.

Warning: DO NOT interrupt during the upgrade.

Browse Confirm

After the firmware upgrade, please reset the router back to factory default so that the new firmware can take effect. Then run EZMAX Wizard to setup the router to the internet. All other functions are on top menu.

5. Web Configuration

The router can also be configured using the web-based configuration interface. Follow the instructions below.

5.1. Accessing the Router

To access the web-based configuration interface:

1. Open the Internet Explorer (IE) browser and enter <http://192.168.2.1>.
2. In the **Login** page that is displayed, enter the username and password.
 - The username and password of the super user are **admin** and **1234**.
 - The username and password of a common user are **user** and **user**.



 **Note:**
In the Web configuration page, the settings can be saved permanently.

5.2. Status

In the navigation bar, click **Status**. In the **Status** page that is displayed contains **Device Info**, **System Log** and **Statistics**.

5.2.1. Device Info

Choose **Status** > **Device Info**. The page that is displayed shows the current status and some basic settings of the router, such as model number, software version, LAN, WAN and ADSL information.

EDIMAX
NETWORKING PEOPLE TOGETHER

ADSL Router

Status Quick Start Interface Setup Advanced Setup Access Management Maintenance **Status**

Device Info System Log Statistics

Device Information

Model Name : AR-7286WnA
Software Version : V1.0.1
MAC Address : 00:1fa4:92:49:ee

LAN

IP Address : 192.168.2.1
Subnet Mask : 255.255.255.0
DHCP Server : Enabled

WAN

Virtual Circuit : PVC0
Status : Not Connected
Connection Type : Bridge
IP Address : N/A
Subnet Mask : N/A
Default Gateway : N/A
Primary DNS : N/A
Secondary DNS : N/A

ADSL

ADSL Firmware Version : FwVer:3.20.29.0_TC3087 HwVer:T14.F7_11.2
Line State : Down
Modulation : N/A
Annex Mode : N/A

	Downstream	Upstream	
SNR Margin :	N/A	N/A	db
Line Attenuation :	N/A	N/A	db
Data Rate :	N/A	N/A	kbps

5.2.2. System Log

Choose **Status > System Log**, the page shown in the following figure appears. In this page, you can view, clear or save the system log.

Status Quick Start Interface Setup Advanced Setup Access Management Maintenance **Status**

Device Info System Log Statistics

System Log

```

1/1/2000 0:1:8> adjtime task pause 1 day
1/1/2000 0:1:9> netMakeChannDial: err=-3001
rn_p=804b9980
1/1/2000 0:2:8> Last errorlog repeat 40 Times
1/1/2000 0:2:8> No DNS server available
1/1/2000 0:2:8> adjTimeTask fail: wrong domain name
1/1/2000 0:2:8> No DNS server available
1/1/2000 0:2:8> adjTimeTask fail: wrong domain name
1/1/2000 0:2:8> adjTimeTask fail: no server available
1/1/2000 0:2:8> adjtime task pause 60 seconds
1/1/2000 0:2:8> No DNS server available
1/1/2000 0:2:8> adjTimeTask fail: wrong domain name
1/1/2000 0:2:8> No DNS server available
1/1/2000 0:2:8> adjTimeTask fail: wrong domain name
1/1/2000 0:2:8> adjTimeTask fail: no server available
1/1/2000 0:2:8> adjtime task pause 60 seconds
1/1/2000 0:2:8> No DNS server available
1/1/2000 0:2:8> adjTimeTask fail: wrong domain name
1/1/2000 0:2:8> adjTimeTask fail: no server available
1/1/2000 0:2:8> adjtime task pause 1 day
1/1/2000 0:2:11> netMakeChannDial: err=-3001
rn_p=804b9980
1/1/2000 0:2:25> Last errorlog repeat 5 Times

```

CLEAR LOG SAVE LOG

5.2.3. Statistics

Choose **Status > Statistics**. The **Statistics** page that is displayed contains **Ethernet Statistics**, **ADSL Statistics** and **WLAN Statistics**.

5.2.3.1. Ethernet Statistics

In the Traffic Statistics page, click **Ethernet** and the page shown in the following figure appears. In this page, you can view the statistics such as total Bytes, Collision, Error Frames and CRC Errors.

The screenshot shows a web interface with a navigation menu at the top. The 'Status' menu is expanded, showing 'Device Info', 'System Log', and 'Statistics'. The 'Statistics' page is active, displaying 'Traffic Statistics' for the 'Ethernet' interface. The interface selection is 'Ethernet' (selected), 'ADSL', and 'WLAN'. Below this, there are two tables: 'Transmit Statistics' and 'Receive Statistics'.

Transmit Statistics		Receive Statistics	
Transmit Frames	123	Receive Frames	134
Transmit Multicast Frames	251	Receive Multicast Frames	196
Transmit total Bytes	81719	Receive total Bytes	39657
Transmit Collision	0	Receive CRC Errors	0
Transmit Error Frames	0	Receive Under-size Frames	0

A 'REFRESH' button is located at the bottom of the page.

5.2.3.2. ADSL Statistics

In the Traffic Statistic page, click **ADSL** and the page shown in the following figure appears. In this page, you can view the ADSL line statistics such as total PDUs, total Error Counts.

The screenshot shows the same web interface as above, but with the 'ADSL' interface selected. The 'Traffic Statistics' page displays statistics for the 'ADSL' interface. The interface selection is 'Ethernet', 'ADSL' (selected), and 'WLAN'. Below this, there are two tables: 'Transmit Statistics' and 'Receive Statistics'.

Transmit Statistics		Receive Statistics	
Transmit total PDUs	0	Receive total PDUs	0
Transmit total Error Counts	0	Receive total Error Counts	0

A 'REFRESH' button is located at the bottom of the page.

5.2.3.1. WLAN Statistics

In the Traffic Statistic page, click **WLAN** and the page shown in the following figure appears. In this page, you can view the WLAN statistics such as transmit/receive frames count, errors count and drops count.

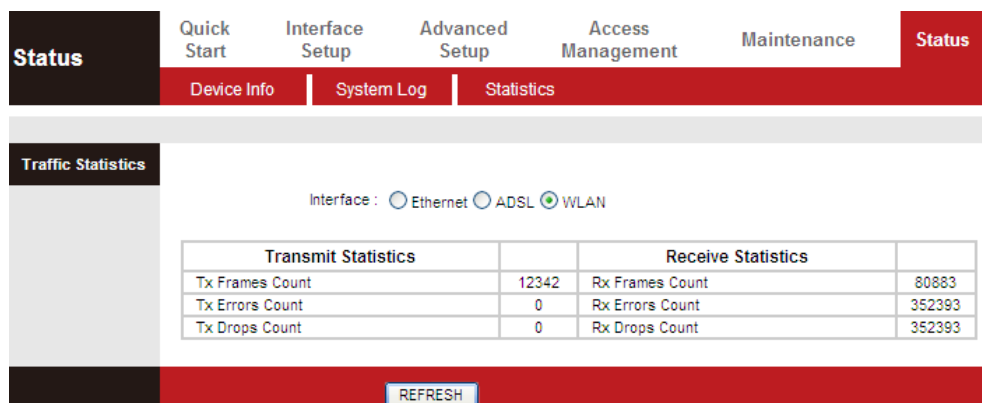

5.3. Quick Start

The **Quick Start** page will guide you to configure the ADSL router to connect to your ISP (Internet Service Provider). The following sections describe these various configuration parameters. Whether you configure these parameters or use the default ones, click **NEXT** to enable your Internet connection.

When subscribing to a broadband service, you should be aware of the method by which you are connected to the Internet. Your physical WAN device can be either PPP, ADSL or both. Technical information about your Internet connection is provided by your Internet service provider (ISP). For example, your ISP provides you with the IP address (a static or dynamic IP address) for connecting to the Internet, and the protocol for communication on the Internet.

In the navigation bar, click **Quick Start**. The page as shown in the following figure appears.

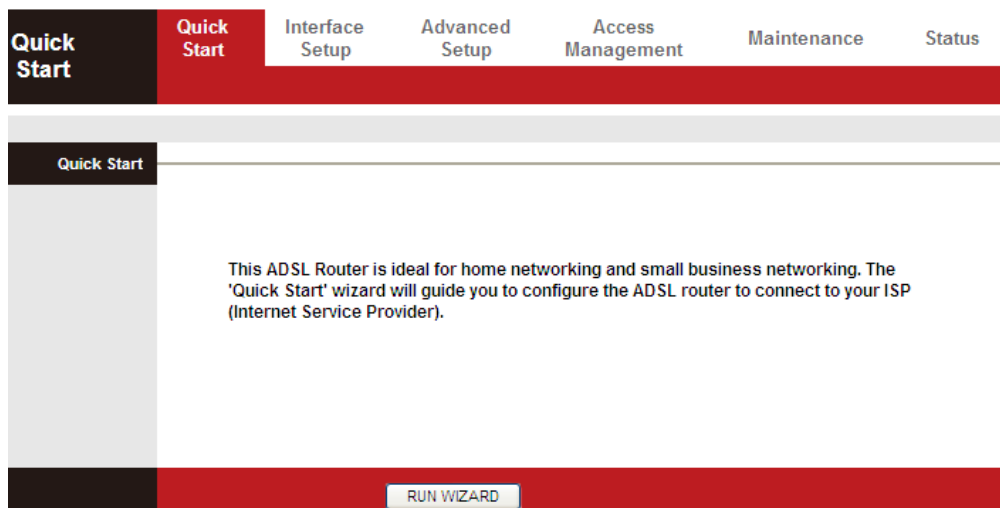

1. Click **RUN WIZARD**, there will pop up a new page as shown in the following figure appears.

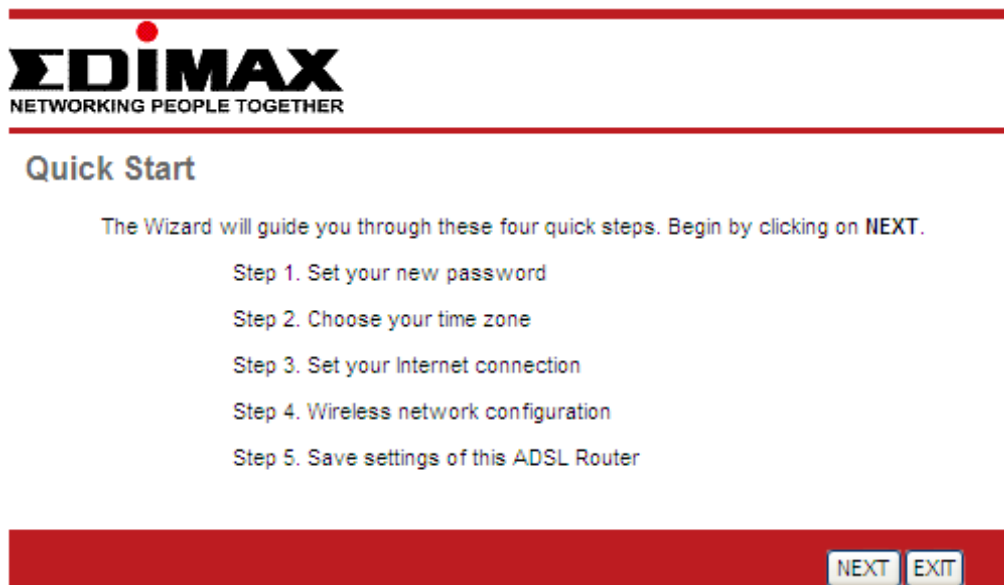

2. Click **EXIT**, this page will be closed. Click **NEXT**, the page as shown in the following figure appears.

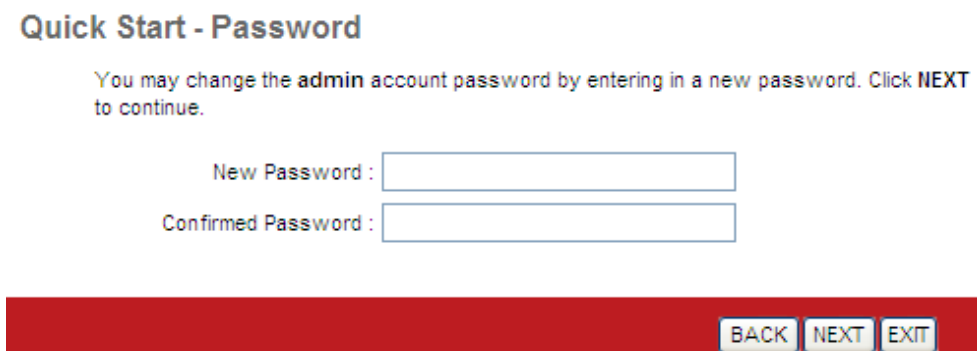

In this page, enter a new password for the admin account. After finishing all quick start settings, it will be saved and effect immediately.

3. Click **NEXT**, the page as shown in the following figure appears.

Quick Start - Time Zone

Select the appropriate time zone for your location and click **NEXT** to continue.

(GMT) Greenwich Mean Time : Dublin, Edinburgh, Lisbon, London

BACK NEXT EXIT

In this page, you can select a local time zone.

4. Click **NEXT**, the page as shown in the following figure appears.

Quick Start - ISP Connection Type

Select the internet connection type to connect to your ISP. Click **NEXT** to continue.

Auto setup by ISP list Choose from ISP List to set your ISP information.

Dynamic IP Address Choose this option to obtain a IP address automatically from your ISP.

Static IP Address Choose this option to set static IP information provided to you by your ISP.

PPPoE/PPPoA Choose this option if your ISP uses PPPoE/PPPoA. (For most DSL users)

Bridge Mode Choose this option if your ISP uses Bridge Mode.

BACK NEXT EXIT

You may select **Auto setup by ISP list**, **Dynamic IP Address**, **Static IP Address**, **PPPoE/PPPoA** or **Bridge Mode**.

5.3.1. Auto setup by ISP list

Select **Auto setup by ISP list**, click **NEXT**, and the page as shown in the following figure appears.

Quick Start - Auto setup by ISP list

Choose from ISP List to set your ISP information. Click **NEXT** to continue.

Country: (Click to select) ▼
ISP: (Click to select) ▼
VPI: (Enter a number) (0~255)
VCI: (Enter a number) (1~65535)
Connection Type: 1483 Bridged IP VC-Mux(Bridge) ▼

BACK NEXT EXIT

The following table describes the parameters in this page:

Field	Description
Country	Select the country you are in.
ISP	Select your Internet Service Provider (ISP).
VPI	Virtual path identifier (VPI) is the virtual path between two points in an ATM network. Its valid value is between 0 and 255. Enter the correct VPI provided by your ISP.
VCI	Virtual channel identifier (VCI) is the virtual channel between two points in an ATM network. Its valid value is between 1 and 65535. Enter the correct VCI provided by your ISP.
Connection Type	Select a connection type from the dropdown list. You may select PPPoE/ PPPoA/ Dynamic IP/ Static IP/ Routed IP/ Bridge.

5.3.2. Bridge Mode

Select **Bridge Mode**, click **NEXT**, and the page shown in the following figure will appear.

Quick Start - Bridge Mode

Enter the bridge information provided to you by your ISP. Click **NEXT** to continue.

VPI: 8 (0~255)
VCI: 35 (1~65535)
Connection Type: 1483 Bridged IP LLC ▼

BACK NEXT EXIT

The following table describes the parameters in this page:

Field	Description
VPI	Virtual path identifier (VPI) is the virtual path between two points in an ATM network. Its valid value is between 0 and 255. Enter the correct VPI provided by your ISP. By default, VPI is set to 8 .
VCI	Virtual channel identifier (VCI) is the virtual channel between two points in an ATM network. Its valid value is between 1 and 65535. Enter the correct VCI provided by your ISP. By default, VCI is set to 35 .
Connection Type	You can select LLC or VC-Mux . In this example, the encapsulation mode is set to 1483 Bridged IP LLC .

5.3.3. Dynamic IP Address

For configuration method, please refer to that of Auto setup by ISP list. Select **Auto setup by ISP list**, click **NEXT**, and the page as shown in the following figure appears.

Quick Start - Auto setup by ISP list

Choose from ISP List to set your ISP information. Click **NEXT** to continue.

Country:

ISP:

VPI:

VCI:

Connection Type:

The following table describes the parameters in this page:

Field	Description
Country	Select the country you are in.
ISP	Select your Internet Service Provider (ISP).
VPI	Virtual path identifier (VPI) is the virtual path between two points in an ATM network. Its valid value is between 0 and 255. Enter the correct VPI provided by your ISP.
VCI	Virtual channel identifier (VCI) is the virtual channel between

Field	Description
	two points in an ATM network. Its valid value is between 1 and 65535. Enter the correct VCI provided by your ISP.
Connection Type	Select a connection type from the dropdown list. You may select PPPoE/ PPPoA/ Dynamic IP/ Static IP/ Routed IP/ Bridge.

Bridge Mode.

Static IP Address

Select **Static IP Address**, click **NEXT**, and the page as shown in the following figure will appear.

Quick Start - Static IP Address

Enter the static IP information provided to you by your ISP. Click **NEXT** to continue.

VPI: (0~255)
VCI: (1~65535)
IP Address:
Subnet mask:
ISP Gateway:
Connection Type: ▼

[BACK](#) [NEXT](#) [EXIT](#)

The following table describes the parameters in this page:

Field	Description
VPI	Virtual path identifier (VPI) is the virtual path between two points in an ATM network. Its valid value is between 0 and 255. Enter the correct VPI provided by your ISP. By default, VPI is set to 8 .
VCI	Virtual channel identifier (VCI) is the virtual channel between two points in an ATM network. Its valid value is between 1 and 65535. Enter the correct VCI provided by your ISP. By default, VCI is set to 35 .
IP Address	Enter the IP address provided by your ISP.
Subnet	Enter the subnet mask provided by your ISP.

Field	Description
Mask	
ISP Gateway	Enter the default gateway provided by your ISP.
Connection Type	You can select LLC or VC-Mux . In this example, the encapsulation mode is set to 1483 Bridged IP LLC .

5.3.4. PPPoE/PPPoA

Select **PPPoE/PPPoA**, click **NEXT**, and the page as shown in the following figure will appear.

Quick Start - PPPoE/PPPoA

Enter the PPPoE/PPPoA information provided to you by your ISP. Click **NEXT** to continue.

Username:

Password:

VPI: (0~255)

VCI: (1~65535)

Connection Type:

The following table describes the parameters in this page:

Field	Description
Username	Enter the username for PPPoE dial-up, which is provided by your ISP.
Password	Enter the password for PPPoE dial-up, which is provided by your ISP.
VPI	Virtual path identifier (VPI) is the virtual path between two points in an ATM network. Its valid value is between 0 and 255. Enter the correct VPI provided by your ISP. By default, VPI is set to 8 .
VCI	Virtual channel identifier (VCI) is the virtual channel between two points in an ATM network. Its valid value is between 1 and 65535. Enter the correct VCI provided by your ISP. By default, VCI is set to 35 .
Connection	You can select LLC or VC-Mux . In this example, the

Field	Description
Type	encapsulation mode is set to PPPoE LLC .

After setting, click **NEXT**, the page as shown in the following figure appears.

Quick Start Complete !!

The Setup Wizard has completed. Click on **BACK** to modify changes or mistakes. Click **NEXT** to save the current settings.



Click **BACK** to modify the settings.

Click **NEXT** to save the settings.

Click **EXIT** to cancel the settings.

Note:

After you saving the settings in the **Quick Start** page, you can view this wan connection settings in the **Interface Setup > Internet** page.

5.4. Interface Setup

In the navigation bar, click **Interface Setup**. The **Interface Setup** page that is displayed contains **Internet**, **LAN** and **Wireless**.

5.4.1. Internet

Choose **Interface Setup > Internet**. The **Internet** page that is displayed contains **ATM VC**, **Qos**, **IPv4/IPv6** and **Encapsulation**.

Click **Internet** pane, the page shown in the following figure appears. In this page, you can configure the WAN interface of your router.

Interface Quick Start **Interface Setup** Advanced Setup Access Management Maintenance Status

Internet LAN **Wireless**

ATM VC

Virtual Circuit: PVC0

Status: Activated Deactivated

VPI: 8 (range: 0~255)

VCI: 35 (range: 1~65535)

QoS

ATM QoS: UBR

PCR: 0 cells/second

SCR: 0 cells/second

MBS: 0 cells

IPv4/IPv6

IP Version: IPv4 IPv4/IPv6 IPv6

Encapsulation

ISP: Dynamic IP Address
 Static IP Address
 PPPoA/PPPoE
 Bridge Mode

Bridge Mode

Encapsulation: 1483 Bridged IP LLC

The following table describes the parameters of this page:

Field	Description
Virtual Circuit	Select a virtual circuit from the drop-list. Click PVCs Summary to view eight PVCs (from PVC0 to PVC7), and only PVC0 status is activated by default.
Status	You can select Activated or Deactivated for currently selected virtual circuit.
VPI	The virtual path between two points in an ATM network, ranging from 0 to 255.
VCI	The virtual channel between two points in an ATM network, ranging from 1 to 65535.
ATM QoS	Select the Quality of Service types for this Virtual Circuit. The ATM QoS types include CBR (Constant Bit Rate), VBR (Variable Bit Rate) and UBR (Unspecified Bit Rate). These QoS types are all controlled by the parameters specified below, including PCR, SCR and MBS. You can choose CBR, UBR, rtVBR, or nrtVBR.

Field	Description
PCR	Peak cell rate (PCR) is the maximum rate at which cells can be transmitted along a connection in the ATM network.
SCR	Sustain cell rate (SCR) is the maximum rate that traffic can pass over PVC without the risk of cell loss.
MBS	Maximum burst size (MBS) is the maximum number of cells that can be transmitted at the PCR.
IP Version	Supports IPv4/v6 Dual Stack Internet Protocol. You can select IPv4 , IPv4/IPv6 or IPv6 .
ISP	You can choose Dynamic IP Address , Static IP Address , PPPoA/PPPoE or Bridge Mode .

Configuration for different encapsulation modes are described below with the IP Version set to **IPv4/IPv6**.

If your ISP provides an IP address automatically, you may select **Dynamic IP** in the **ISP** encapsulation. Dynamic IP is typically used for Cable services. Please enter the Dynamic IP information accordingly.

IPv4/IPv6

IP Version : IPv4 IPv4/IPv6 IPv6

Encapsulation

ISP : Dynamic IP Address
 Static IP Address
 PPPoA/PPPoE
 Bridge Mode

Dynamic IP

IP Common Options

Encapsulation : ▼
IP Unnumbered : Activated Deactivated
Default Route : Yes No
TCP MTU Option : TCP MTU(default:1500) bytes

IPv4 Address

NAT : ▼
Dynamic Route : ▼ Direction : ▼
Multicast : ▼

IPv6 Address

IPv6 Message Fetch Type : Dynamic Mode
DHCP IPv6 Enable : DHCP SLACC
DHCP PD Enable : Enable Disable
MLD Proxy : Enable Disable

Dual Stack Lite

Enable : Enable Disable

SAVE

The following table describes the parameters of this page:

Field	Description
IP Common Options	
Encapsulation	You can choose 1483 Bridged IP LLC , 1483 Bridged IP VC-Mux , 1483 Routed IP LLC(IPoA) or 1483 Routed IP VC-Mux .
IP Unnumbered	You can choose Activated or Deactivated .
Default Route	You can enable or disable the default route. If enabled, the current PVC will be the default gateway to the Internet from this device.
TCP MTU Option	You can set a TCP MTU value. The range is from 100 to 1500. The default is 1492 .
IPv4 Address	
NAT	Select whether to enable Network Address Translation (NAT) function. If you do not enable NAT, you must add a route on the uplink equipment, otherwise Internet access will fail. Normally NAT is enabled.
Dynamic Route	Select this option to specify the Routing Information protocol (RIP) version. You can select RIP1 , RIP2-B or RIP2-M .
Direction	You can select None , Both , IN Only or OUT Only to specify the RIP direction. None is for disabling the RIP function. Both means the ADSL Router will periodically send routing information and accept routing information then incorporate into routing table. IN only means the ADSL router will only accept but will not send RIP packets. OUT only means the ADSL router will only send but not accept RIP packets.
Multicast	IGMP (Internet Group Multicast Protocol) is a session-layer protocol used to establish membership in a multicast group. The ADSL Router supports both

Field	Description
	IGMP version 1 (IGMP v1) and IGMP version 2 (IGMP v2). Select Disabled to disable it.
IPv6 Address	
DHCP IPv6 Enable	Provide address assignment to hosts to include DHCP in local pools. You can choose DHCP or SLAAC .
DHCP PD Enable	IPv6 Prefix Delegation Options for DHCPv6. You may enable or disable DHCP PD.
MLD Proxy	You may enable or disable MLD Proxy. Mld proxy is enabled only for route mode. It works in an IPv6 environment.
Dual Stack Lite	
Enable	You may Enable or Disable Dual Stack Lite. The ADSL Router support IPv4/v6 Dual Stack Internet Protocol.

Select **Static IP Address** in the **ISP** encapsulation to set static IP information. You will need to enter the Connection type, IP address, subnet mask and gateway address provided by your ISP. Each IP address entered must be in the correct IP format, which is four IP octets separated by a dot (x.x.x.x). The router will not accept an IP address if it is not in this format.

IPv4/IPv6

IP Version : IPv4 IPv4/IPv6 IPv6

Encapsulation

ISP : Dynamic IP Address
 Static IP Address
 PPPoA/PPPoE
 Bridge Mode

Static IP

IP Common Options

Encapsulation : 1483 Routed IP LLC(IPoA) ▼
Default Route : Yes No
TCP MTU Option : TCP MTU(default:1500) 1492 bytes

IPv4 Options

Static IP Address : 0.0.0.0
IP Subnet Mask : 0.0.0.0
Gateway : 0.0.0.0
NAT : Enable ▼
Dynamic Route : RIP2-B ▼ Direction : None ▼
Multicast : Disabled ▼

IPv6 Options

IPv6 Message Fetch Type : Static Mode
IPv6 Address : :: / 0
IPv6 Default Getway : ::
IPv6 DNS Server1 : ::
IPv6 DNS Server2 : ::
MLD Proxy : Enable Disable

Dual Stack Lite

Enable : Enable Disable

SAVE

The following table describes the parameters of this page:

Field	Description
IP Common Options	
Encapsulation	You can choose 1483 Bridged IP LLC , 1483 Bridged IP VC-Mux , 1483 Routed IP LLC(IPoA) or 1483 Routed IP VC-Mux .
Default Route	You can enable or disable default route.
TCP MTU Option	You can set a TCP MTU value. The range is from 100 to 1500. The default is 1492 .
IPv4 Options	
Static IP Address	You can enter the IP address for dial-up, which is provided by your ISP.
IP Subnet Mask	You can enter the IP subnet mask for dial-up, which is provided by your ISP.

Field	Description
Gateway	You can enter the gate way IP for dial-up, which is provided by your ISP.
NAT	Select whether to enable Network Address Translation (NAT) function. If you do not enable NAT, you must add a route on the uplink equipment, otherwise Internet access will fail. Normally NAT is enabled.
Dynamic Route	You can select RIP1 , RIP2-B or RIP2-M .
Direction	You can select None , Both , IN Only or OUT Only .
Multicast	IGMP (Internet Group Multicast Protocol) is a session-layer protocol used to establish membership in a multicast group. The ADSL Router supports both IGMP version 1 (IGMP-v1) and IGMP version 2 (IGMP-v2). Select Disabled to disable it.
IPv6 Options	
IPv6 Address	Set Static IPv6 address.
IPv6 Default Gateway	Set Static IPv6 Gateway.
IPv6 DNS Server1	Set Static IPv6 DNS1.
IPv6 DNS Server2	Set Static IPv6 DNS2.
MLD Proxy	You may enable or disable MLD Proxy. MLD proxy is enabled only for route mode. It works in an IPv6 environment.
Dual Stack Lite	
Enable	You may Enable or Disable the Dual Stack Lite. The ADSL Router support IPv4/v6 Dual Stack Internet Protocol.

Select **PPPoA/PPPoE** in the **ISP** encapsulation if your ISP requires you to use a PPPoE connection. This option is typically used for DSL services. Select Dynamic PPPoE to obtain an IP address automatically for your PPPoE

connection. Select Static PPPoE to use a static IP address for your PPPoE connection. Please enter the information accordingly.

The screenshot shows a network configuration page with the following sections and settings:

- IPv4/IPv6:** IP Version: IPv4 IPv4/IPv6 IPv6
- Encapsulation:** ISP: Dynamic IP Address Static IP Address PPPoA/PPPoE Bridge Mode
- PPPoE/PPPoA:**
 - Servicename:
 - Username:
 - Password:
 - Encapsulation:
 - IP Unnumbered: Activated Deactivated
- Connection Setting:**
 - Connection: Always On (Recommended) Connect On-Demand (Close if idle for minutes) Connect Manually
 - TCP MSS Option: TCP MSS(default:1400) bytes
- IP Common Options:** Default Route: Yes No
- IPv4 Address:**
 - Get IP Address: Static Dynamic
 - Static IP Address:
 - IP Subnet Mask:
 - Gateway:
 - TCP MTU Option: TCP MTU(default:1500) bytes
 - NAT:
 - Dynamic Route: Direction:
 - Multicast:
- IPv6 Address:**
 - DHCP IPv6 Enable: DHCP SLACC
 - DHCP PD Enable: Enable Disable
 - MLD Proxy: Enable Disable
- Dual Stack Lite:** Enable: Enable Disable

A **SAVE** button is located at the bottom of the page.

The following table describes the parameters of this page:

Field	Description
Servicename	You can set the service name.
Username	Enter the username for PPPoE dial-up, which is provided by your ISP.
Password	Enter the password for PPPoE dial-up, which is provided by your ISP.
Encapsulation	You can choose PPPoE LLC , PPPoE VC-Mux , PPPoA LLC or PPPoA VC-Mux .
IP Unnumbered	Select Activated or Deactivated .

Field	Description
Connection Setting	
Connection	You can choose Always On (Recommended) , Connect On-Demand or Connect Manually .
TCP MSS Option	You can set a TCP MSS value. The range is from 100 to 1452. The default is 1400 .
IP Common Options	
Default Route	You can enable or disable default route.
IPv4 Address	
Get IP Address	You can choose Static or Dynamic .
Static IP Address	You can enter the IP address for dial-up, which is provided by your ISP.
IP Subnet Mask	The default is 255.255.255.255 .
Gateway	You can enter the gateway IP for dial-up, which is provided by your ISP.
TCP MTU Option	You can set a TCP MTU value. The range is from 100 to 1500. The default is 1492 .
NAT	Select whether to enable Network Address Translation (NAT) function. If you do not enable NAT, you must add a route on the uplink equipment, otherwise Internet access will fail. Normally NAT is enabled.
Dynamic Route	You can select RIP1 , RIP2-B or RIP2-M .
Direction	You can select None , Both , IN Only or OUT Only .
Multicast	IGMP (Internet Group Multicast Protocol) is a session-layer protocol used to establish membership in a multicast group. The ADSL Router supports both IGMP version 1 (IGMP v1) and IGMP version 2 (IGMP v2). Select Disabled to disable it.
IPv6 Address	
DHCP IPv6	Provide address assignment to hosts to include

Field	Description
Enable	DHCP in local pools. Choose DHCP or SLAAC .
DHCP PD Enable	IPv6 Prefix Delegation Options for DHCPv6. You may enable or disable DHCP PD.
MLD Proxy	You may enable or disable MLD Proxy. MLD proxy is enabled only for route mode. It works in an IPv6 environment.
Dual Stack Lite	
Enable	You may Enable or Disable the Dual Stack Lite. The ADSL Router support IPv4/v6 Dual Stack Internet Protocol.

Select **Bridge Mode** in the **ISP** encapsulation if you want to use pass-through transmission mode.

The screenshot shows a configuration page with a sidebar on the left containing menu items: IPv4/IPv6, Encapsulation, Dual Stack Lite, Bridge Mode, and another unlabeled item. The main content area is divided into sections:

- IP Version:** Radio buttons for IPv4, IPv4/IPv6 (selected), and IPv6.
- ISP:** Radio buttons for Dynamic IP Address, Static IP Address, PPPoA/PPPoE, and Bridge Mode (selected).
- Dual Stack Lite:** Radio buttons for Enable and Disable (selected).
- Encapsulation:** A dropdown menu currently showing '1483 Bridged IP LLC'.

At the bottom of the configuration area, there are two buttons: 'SAVE' and 'DELETE'.

Field	Description
Dual Stack Lite	
Enable	You may Enable or Disable the Dual Stack Lite. The ADSL Router supports IPv4/v6 Dual Stack Internet Protocol.
Encapsulation	You can choose 1483 Bridged IP LLC or 1483 Bridged IP VC-Mux .

After finishing, click **SAVE** to apply the settings of this PVC.

5.4.2. LAN

Choose **Interface Setup > LAN**. The **LAN** page that is displayed contains **Router Local IP, DHCP Server, DNS, Radvd and DHCPv6**. In this page, you can change the IP address of the router. The default IP address is 192.168.2.1, which is the private IP address of the router.

The screenshot shows the LAN configuration page with the following sections and settings:

- Router Local IP:**
 - Main IP Address: 192.168.2.1
 - Main Subnet Mask: 255.255.255.0
 - Alias IP Address: 0.0.0.0
 - Alias Subnet Mask: 0.0.0.0
 - Dynamic Route: RIP2-B (dropdown), Direction: None (dropdown)
 - Multicast: IGMP v2 (dropdown)
 - IGMP Snoop: Disabled Enabled
- DHCP:**
 - DHCP: Disabled Enabled Relay
- DHCP Server:**
 - Starting IP Address: 192.168.2.100 (with Current Pool Summary button)
 - IP Pool Count: 100
 - Lease Time: 259200 seconds (0 sets to default value of 259200)
 - Physical Ports: 1 2 3 4
- DNS:**
 - DNS Relay: Use Auto Discovered DNS Server Only (dropdown)
 - Primary DNS Server: N/A
 - Secondary DNS Server: N/A
- Radvd:**
 - Radvd Enable: Disable Enable
 - Radvd Mode: Auto Manual
 - Auto Prefix: Enable Disable
 - RA Flags Set: ManagedAddr Other Config
- DHCPv6:**
 - DHCPv6 Server: Disable Enable
 - DHCPv6 Mode: Auto Manual

At the bottom of the page, there are **SAVE** and **CANCEL** buttons.

The following table describes the parameters of this page:

Field	Description
Main IP Address	Enter the IP address of LAN interface. It is recommended to use an address from a block reserved for private use. This address block is 192.168.1.1-192.168.255.254.
Main Subnet	Enter the subnet mask of LAN interface. The range of

Field	Description
Mask	subnet mask is from 255.255.0.0 to 255.255.255.254.
Alias IP Address	You may enter the second IP Address.
Alias Subnet Mask	You may enter a second subnet mask.
Dynamic Route	You can select RIP1 , RIP2-B or RIP2-M .
Direction	You can select None , Both , IN Only or OUT Only .
Multicast	IGMP (Internet Group Multicast Protocol) is a session-layer protocol used to establish membership in a multicast group. The ADSL Router supports both IGMP version 1 (IGMP v1) and IGMP version 2 (IGMP v2). Select Disabled to disable it.
IGMP Snoop	You may select Enabled or Disabled . After activating this function, the packets of the IGMP broadcast will not be sent to the LAN interface not belonging to the group.
DHCP	You can choose Disabled , Enabled or Relay . If set to DHCP Server , the router can assign IP addresses, IP default gateway and DNS Servers to the host under Windows95, Windows NT and other operating systems that support the DHCP client.
Starting IP Address	The starting IP address for the DHCP server's IP assignment.
IP Pool Count	The max user pool size.
Lease Time	The lease time determines the period that the host retains the assigned IP addresses before the IP addresses change. The default is 259200 seconds.
Physical Ports	When no port is selected, the LAN PC can't get an IP from the router.
DNS Relay	You can choose Use Auto Discovered DNS Server Only or Use User Discovered DNS Server Only . If you select

Field	Description
	Auto Discovered , the router accepts the firstly-received DNS assignment from one of the PPPoA, PPPoE or MER enabled PVC(s) during the connection establishment. If select User Discovered , enter the IP addresses of the primary and secondary DNS servers.
Primary DNS Server	DNS server FOR wan and LAN
Secondary DNS Server	DNS server FOR wan and LAN
Radvd Enable	You may choose to enable or disable Radvd. The Router Advertisement Daemon (Radvd) is an open-source software product that implements link-local advertisements of IPv6 router addresses and IPv6 routing prefixes using the Neighbor Discovery Protocol (NDP).
Radvd Mode	You may choose Auto or Manual .
Auto Prefix	Select Enable or Disable .
RA Flag Set	You may choose ManagedAddr or Other Config .
DHCP6 Server	You may choose to enable or disable DHCP6 Server.
DHCP6 Mode	You may choose Auto or Manual for the DHCP6 Server.

Dynamic Host Configuration Protocol (DHCP) allows the individual PC to obtain the TCP/IP configuration from the centralized DHCP server. You can configure this router as a DHCP server or disable it. The DHCP server can assign IP address, IP default gateway and DNS server to DHCP clients. This router can also act as a surrogate DHCP server (DHCP proxy) where it relays IP address assignment from an actual DHCP server to clients. You can enable or disable DHCP server or DHCP proxy.

In the **DHCP** field, choose **Disabled**, the page shown in the following figure appears.

Interface	Quick Start	Interface Setup	Advanced Setup	Access Management	Maintenance	Status
	Internet	LAN	Wireless			
Router Local IP	Main IP Address : <input type="text" value="192.168.2.1"/> Main Subnet Mask : <input type="text" value="255.255.255.0"/> Alias IP Address : <input type="text" value="0.0.0.0"/> Alias Subnet Mask : <input type="text" value="0.0.0.0"/> Dynamic Route : <input type="text" value="RIP2-B"/> Direction : <input type="text" value="None"/> Multicast : <input type="text" value="IGMP v2"/> IGMP Snoop : <input type="radio"/> Disabled <input checked="" type="radio"/> Enabled					
DHCP	DHCP : <input checked="" type="radio"/> Disabled <input type="radio"/> Enabled <input type="radio"/> Relay					
Radvd	Radvd Enable : <input type="radio"/> Disable <input checked="" type="radio"/> Enable Radvd Mode : <input checked="" type="radio"/> Auto <input type="radio"/> Manual Auto Prefix : <input checked="" type="radio"/> Enable <input type="radio"/> Disable RA Flags Set : <input checked="" type="checkbox"/> ManagedAddr <input checked="" type="checkbox"/> Other Config					
DHCPv6	DHCPv6 Server : <input type="radio"/> Disable <input checked="" type="radio"/> Enable DHCPv6 Mode : <input checked="" type="radio"/> Auto <input type="radio"/> Manual					
<input type="button" value="SAVE"/> <input type="button" value="CANCEL"/>						

In the **DHCP** field, choose **DHCP Relay**, the page shown in the following figure appears. Enter a server IP address running on WAN side.

Interface	Quick Start	Interface Setup	Advanced Setup	Access Management	Maintenance	Status
	Internet	LAN	Wireless			
Router Local IP	Main IP Address : <input type="text" value="192.168.2.1"/> Main Subnet Mask : <input type="text" value="255.255.255.0"/> Alias IP Address : <input type="text" value="0.0.0.0"/> Alias Subnet Mask : <input type="text" value="0.0.0.0"/> Dynamic Route : <input type="text" value="RIP2-B"/> Direction : <input type="text" value="None"/> Multicast : <input type="text" value="IGMP v2"/> IGMP Snoop : <input type="radio"/> Disabled <input checked="" type="radio"/> Enabled					
DHCP	DHCP : <input type="radio"/> Disabled <input type="radio"/> Enabled <input checked="" type="radio"/> Relay					
DHCP Relay	DHCP Server IP for Relay Agent : <input type="text" value="0.0.0.0"/>					
Radvd	Radvd Enable : <input type="radio"/> Disable <input checked="" type="radio"/> Enable Radvd Mode : <input checked="" type="radio"/> Auto <input type="radio"/> Manual Auto Prefix : <input checked="" type="radio"/> Enable <input type="radio"/> Disable RA Flags Set : <input checked="" type="checkbox"/> ManagedAddr <input checked="" type="checkbox"/> Other Config					
DHCPv6	DHCPv6 Server : <input type="radio"/> Disable <input checked="" type="radio"/> Enable DHCPv6 Mode : <input checked="" type="radio"/> Auto <input type="radio"/> Manual					
<input type="button" value="SAVE"/> <input type="button" value="CANCEL"/>						

5.4.3. Wireless

Choose **Interface Setup > Wireless**. The page as shown in the following figure appears. The Wireless page contains **Access Point Settings, 11n Settings, Multiple SSIDs Settings, WPS Settings** and **Wireless MAC Address Filter**.

The screenshot shows a web interface for configuring wireless settings. The top navigation bar includes 'Interface', 'Quick Start', 'Interface Setup' (selected), 'Advanced Setup', 'Access Management', 'Maintenance', and 'Status'. Under 'Interface Setup', there are sub-tabs for 'Internet', 'LAN', and 'Wireless' (selected). The main content area is divided into several sections:

- Access Point Settings:** Includes 'Access Point' (radio buttons for 'Activated' and 'Deactivated'), 'Current Channel' (input field with value 2), 'Beacon Interval' (input field with value 100, range 20-1000), 'RTS/CTS Threshold' (input field with value 2347, range 1500-2347), 'Fragmentation Threshold' (input field with value 2346, range 256-2346, even numbers only), 'DTIM' (input field with value 1, range 1-255), and 'Wireless Mode' (dropdown menu with value 802.11b+g+n).
- 11n Settings:** Includes 'Channel Bandwidth' (dropdown menu with value 40 MHz), 'Extension Channel' (dropdown menu with value above the control channel), 'Guard Interval' (dropdown menu with value AUTO), and 'MCS' (dropdown menu with value AUTO).
- Multiple SSIDs Settings:** Includes 'SSID Index' (dropdown menu with value 1), 'Broadcast SSID' (radio buttons for 'Yes' and 'No'), and 'Use WPS' (radio buttons for 'Yes' and 'No').
- WPS Settings:** Includes 'WPS state' (text: Configured), 'WPS mode' (radio buttons for 'PIN code' and 'PBC'), a 'Start WPS' button, 'WPS progress' (text: Idle), a 'Reset to OOB' button, 'SSID' (input field with value EdimaxADSL), and 'Authentication Type' (dropdown menu with value Disabled).
- Wireless MAC Address Filter:** Includes 'Active' (radio buttons for 'Activated' and 'Deactivated'), 'Action' (dropdown menu with value Allow Association), and a list of 8 'Mac Address' input fields, all with the value 00:00:00:00:00:00.

At the bottom of the page, there are 'SAVE' and 'CANCEL' buttons.

The following table describes the parameters of this page:

Field	Description
Access Point Settings	
Access Point	You may choose Activated or Deactivated .
Current Channel	Countries apply their own regulations to both the allowable channels, allowed users and maximum

Field	Description
	power levels within these frequency ranges. The default is 2 .
Beacon Interval	Beacon Interval range is from 20 to 1000 .
RTS/CTS Threshold	RTS/CTS Threshold range is from 1500 to 2347 .
Fragmentation Threshold	Enter a Fragmentation Threshold between 256 and 2346 (even numbers only) .
DTIM	DTIM range is from 1 to 255 . A delivery traffic indication message is a kind of traffic indication message (TIM) which informs the clients of the presence of buffered multicast/broadcast data on the access point.
Wireless Mode	Comply with the IEEE 802.11b/g and IEEE802.11n standards. You can select 802.11b , 802.11g , 802.11b+g , 802.11n , 802.11g+n or 802.11b+g+n .
11n Settings	
Channel Bandwidth	Supports 20MHz/40MHz Dual Channel.
Extension Channel	The field displays whether the current extension channel is above or below the current control channel.
Guard Interval	You can set 800 nsec or AUTO .
MCS	You can set an MCS index between 0 and 7 , or select AUTO .
Multiple SSIDs Settings	
SSID index	Select SSID to be modified.
Broadcast SSID	Select whether the router broadcasts SSID or not. You can select Yes or No . <ul style="list-style-type: none"> ● Select Yes, and the wireless client searches the router through broadcasting SSID. ● Select No to hide SSID. SSID is not visible to

Field	Description
	wireless client searches.
Use WPS	WPS technology allows new customers without a previously-established account to securely connect to your network at the Wi-Fi hotspot, create and pay for an account, and access the Internet.
WPS Settings	
WPS state	WPS state is displayed here.
WPS mode	Select PIN code or PBC .
Start WPS	Click to start WPS..
WPS progress	Indicates current WPS progress status.
Reset to OOB	Click Reset to OOB (out of box) to reset all Wi-Fi settings to default.
SSID	Enter an SSID. The service set identification (SSID) is a unique name to identify the router in the wireless LAN.
Authentication Type	Select from Disabled, WEP-64Bits, WEP-128Bits, WPA-PSK, WPA2-PSK, WPA-PSK/WPA2-PSK .
Wireless MAC Address Filter	
Active	Activate or deactivate wireless MAC address filter.
Action	Set Allow or Deny for listed MAC addresses. This function can be used to allow or deny access to certain wireless clients based on their MAC Address.
Mac Address #1–8	You can set up to eight MAC addresses.

5.5. Advanced Setup

In the navigation bar, click **Advanced Setup**. In the **Advanced Setup** page that is displayed contains **Firewall, Routing, NAT, QoS, VLAN** and **ADSL**.

5.5.1. Firewall

Choose **Advanced Setup > Firewall**. The page shown in the following figure appears. You can select this option to automatically detect and block Denial of Service (DoS) attacks such as Ping of Death, SYN Flood, Port Scan and Land Attack.

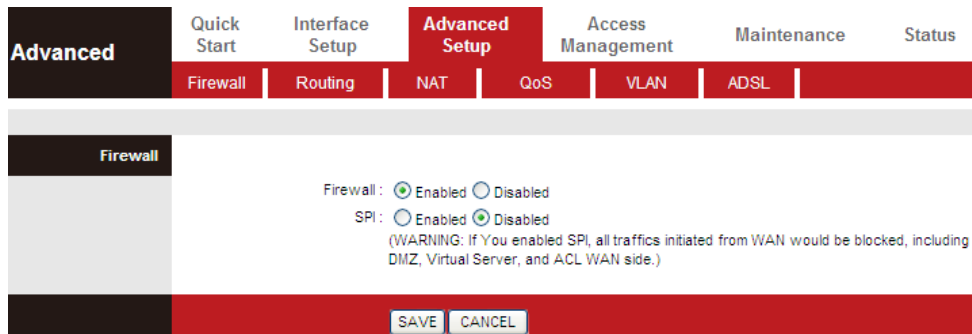

5.5.2. Routing

Click **Advanced Setup > Routing**, the page shown in the following figure appears. It displays routing table information.

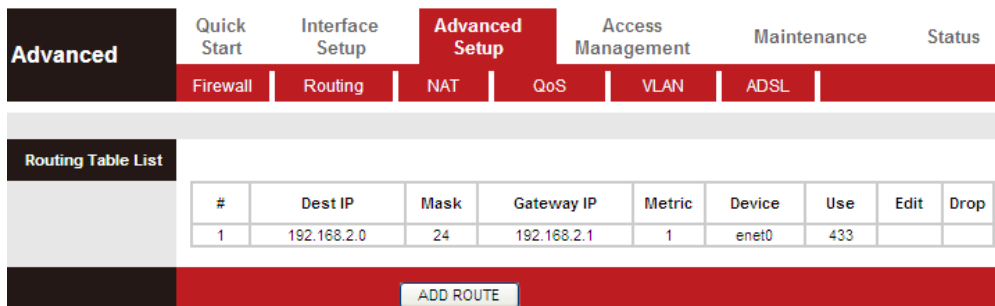

Click **ADD ROUTE**, the page shown in the following figure appears. This page is used to configure the routing information. You may add, edit or drop the static route.

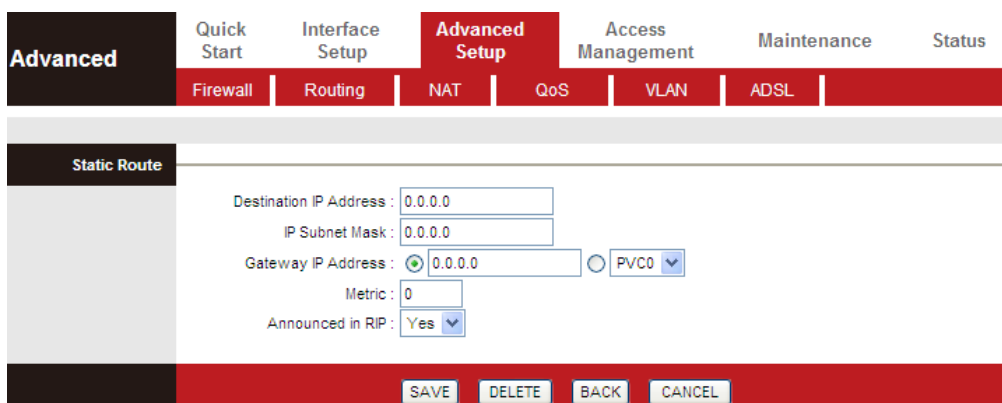

The following table describes the parameters and buttons of this page:

Field	Description
Destination IP Address	Enter the IP address of the destination device.
IP Subnet Mask	Enter the subnet mask of the destination device.
Gateway IP Address	You can enter the IP address of the next hop in the IP route to the destination device, or bind with a PVC interface.
Metric	The metric cost for the destination.
Announced in RIP	This parameter determines if the ADSL router will include the route to this remote node in its RIP broadcasts. If set to Yes , the route to this remote node will be propagated to other hosts through RIP broadcasts. If No , this route is kept private and is not included in RIP broadcasts.

5.5.3. NAT

Click **Advanced Setup > NAT**, the page shown in the following figure appears. In this page, you can set up the NAT (Network Address Translation) function for your ADSL router. This function allows you to share one WAN IP address for multiple computers on your LAN.

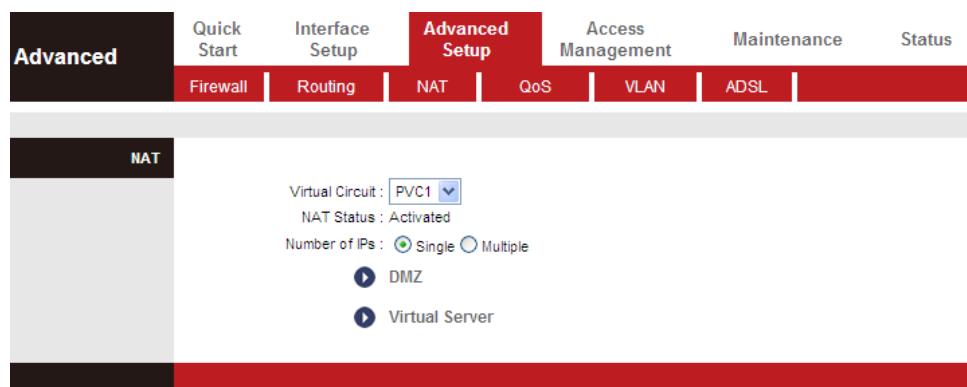

The following table describes the parameters and buttons of this page:

Field	Description
Virtual Circuit	Choose a Virtual Circuit Index to set up for the NAT function.
NAT Status	This field shows the current NAT status for the current VC. The status is enabled or disabled, depending on whether NAT is enabled for the WAN connection.

Field	Description
Number of IPs	This field is to specify how many IPs are provided by your ISP for the current VC. You can select Single or Multiple . When you choose Single , you can set DMZ or Virtual Server . When you choose Multiple , You can set DMZ , Virtual Server or IP Address Mapping (for Multiple IP Service) .



Note:

VCs with a single IP share the same DMZ and Virtual servers. For VCs with multiple IPs, each VC can set DMZ and Virtual servers. Also, VCs with multiple IPs can define the Address Mapping rules. VCs with a single IP do not need to individually define the Address Mapping rule.

Demilitarized Zone (DMZ) is used to provide Internet services without sacrificing unauthorized access to its local private network. Typically, the DMZ host contains devices accessible to Internet traffic, such as web (HTTP) servers, FTP servers, SMTP (e-mail) servers and DNS servers.

In the **NAT** page, choose **DMZ**, and the page shown in the following figure appears.

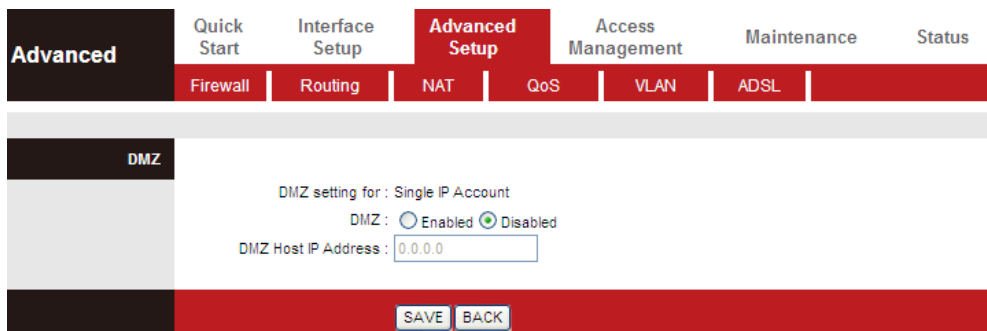

The following table describes the parameters of this page:

Field	Description
DMZ	Select Enabled or Disabled to enable this function.
DMZ Host IP Address	Enter the specified IP Address for the DMZ host on the LAN side.

In the **NAT** page, choose **Virtual Server**, and the page shown in the following figure appears.

The Virtual Server is the server(s) behind NAT (on the LAN), for example, Web server or FTP server, which you can make visible to the outside world even though NAT makes your whole inside network appear as a single machine to the outside world.

Virtual Server for : Single IP Account

Rule Index : 1

Application : -

Protocol : ALL

Start Port Number : 0

End Port Number : 0

Local IP Address : 0.0.0.0

Virtual Server Listing

Rule	Application	Protocol	Start Port	End Port	Local IP Address
1	-	-	0	0	0.0.0.0
2	-	-	0	0	0.0.0.0
3	-	-	0	0	0.0.0.0
4	-	-	0	0	0.0.0.0
5	-	-	0	0	0.0.0.0
6	-	-	0	0	0.0.0.0
7	-	-	0	0	0.0.0.0
8	-	-	0	0	0.0.0.0
9	-	-	0	0	0.0.0.0
10	-	-	0	0	0.0.0.0
11	-	-	0	0	0.0.0.0
12	-	-	0	0	0.0.0.0
13	-	-	0	0	0.0.0.0
14	-	-	0	0	0.0.0.0
15	-	-	0	0	0.0.0.0
16	-	-	0	0	0.0.0.0

SAVE DELETE BACK CANCEL

The following table describes the parameters of this page:

Field	Description
Rule Index	The Virtual server rule index for this VC. You can specify 10 rules in maximum. All the VCs with single IP will use the same Virtual Server rules.

Field	Description
Application	You can enter an application name, or select a name from the right drop-list menu like FTP or TELNET .
Protocol	Choose the transport layer protocol that the service type. You can choose ALL , TCP or UDP .
Start/End Port Number	Enter the specific start and end port number you want to forward. If it is only one port, enter the end port number the same as start port number. For example, if you want to set the FTP Virtual server, you can set the start and end port number to 21.
Local IP Address	Enter the IP Address for the Virtual Server in the LAN.

In the **NAT** page, select Number of IPs as **Multiple**, and then choose **IP Address Mapping (for Multiple IP Service)**, and the page shown in the following figure appears. The IP Address Mapping rule is per-VC based (only for Multiple IPs' VCs).

Advanced Setup

IP Address Mapping

Address Mapping Rule: PVC1

Rule Index: 1

Rule Type: Many-to-One

Local Start IP: 0.0.0.0 (for all local IPs, enter 0.0.0.0 for Start IP)

Local End IP: 255.255.255.255 (for all local IPs, enter 255.255.255.255 for End IP)

Public Start IP: 0.0.0.0 (0.0.0.0 for modem's WAN IP)

Public End IP: N/A

Address Mapping List

Rule	Type	Local Start IP	Local End IP	Public Start IP	Public End IP
1	M-1	0.0.0.0	255.255.255.255	0.0.0.0	...
2	-
3	-
4	-
5	-
6	-
7	-
8	-

SAVE DELETE BACK CANCEL

Entries in this table allow you to configure one IP pool for specified source IP address from LAN, so that one packet whose source IP is in range of the specified address will select one IP address from the pool for NAT.

The following table describes the parameters of this page:

Field	Description
Rule Index	The Virtual server rule index for this VC. You can specify 10 rules in maximum. All the VCs with single IP will use the same Virtual Server rules.
Rule Type	Choose the One-to-One, Many-to-One, Many-to-Many Overload, Many-to-Many No Overload, or Server.
Local Start/End IP	Enter the local IP Address you plan to map to. Local Start IP is the starting local IP address and Local End IP is the ending local IP address. If the rule is for all local IPs, then the Start IP is 0.0.0.0 and the End IP is 255.255.255.255 .
Public Start/End IP	Enter the public IP Address you want to use for NAT. Public Start IP is the starting public IP address and Public End IP is the ending public IP address. If you have a dynamic IP, enter 0.0.0.0 as the Public Start IP.

5.5.4. QoS

The QoS provides better service of selected network traffic over various technologies. This function can be set based on the physical LAN ports or wireless interfaces under IPv4 or IPv6 version respectively.

IP Version: IPv4

Choose **Advanced Setup > QoS**, the page shown in the following figure appears.

[Advanced](#) | [Quick Start](#) | [Interface Setup](#) | **[Advanced Setup](#)** | [Access Management](#) | [Maintenance](#) | [Status](#)

[Firewall](#) | [Routing](#) | [NAT](#) | [QoS](#) | [VLAN](#) | [ADSL](#)

Quality of Service

IP Version : IPv4 IPv6
 QoS : Activated Deactivated
 Summary : [QoS Settings Summary](#)

Rule

Rule Index : 1
 Active : Activated Deactivated
 Application :
 Physical Ports : WLAN Enet1 Enet2 Enet3 Enet4
 Destination MAC (00:00:00:00:00:00) :
 IP :
 Mask :
 Port Range : ~
 Source MAC (00:00:00:00:00:00) :
 IP :
 Mask :
 Port Range : ~
 Protocol ID :
 Vlan ID Range : ~
 IPP/DS Field : IPP/TOS DSCP
 IP Precedence Range : ~
 Type of Service :
 DSCP Range : ~ (Value Range: 0 ~ 63)
 802.1p : ~

Action

IPP/DS Field : IPP/TOS DSCP
 IP Precedence Remarking :
 Type of Service Remarking :
 DSCP Remarking : (Value Range: 0 ~ 63)
 802.1p Remarking :
 Queue # :

The following table describes the parameters of this page:

Field	Description
Quality of Service	
IP Version	In this example, the IP version is set to IPv4 .
QoS	You may select Activated or Deactivated . After activating QoS, you may set the upload bandwidth of the WAN interface.
Summary	Click the QoS Settings Summary button to view the table of QoS rules and actions.
Rule	
Rule Index	You may establish at most 16 QoS rules.
Active	You may select Activated or Deactivated . The QoS rule can be set if it is activated.
Application	Support application options such as IGMP , SIP , H.323 ,

Field	Description
	MGCP, SNMP, DNS, DHCP, RIP, RSTP, RTCP and RTP.
Physical Ports	Choose an Ethernet interface or WLAN Interface.
Destination MAC	The Destination MAC address of the rule. If data packets include the MAC address, the data packets are placed into the group.
IP	The destination IP address of the rule. If data packets include the IP address, the data packets are placed into the group.
Port Range	Port Range is from 0 to 65535 .
Source MAC	The Source MAC address of the rule. If data packets include the MAC address, the data packets are placed into the group.
Protocol ID	You can choose TCP/UDP, TCP, UDP, ICMP or IGMP .
Vlan ID Range	Select this option to Activate/Deactivate the 4094 VID on the 4 different queues. VID (VLAN ID) is the identification of the VLAN, which is basically used by the standard 802.1Q. It has 12 bits and allows the identification of 4096 (2 ¹²) VLANs. Of the 4096 possible VIDs, a VID of 0 is used to identify priority frames and value 4095 (FFF) is reserved, so the maximum possible VLAN configurations are 4,094.
IPP/DS Field	You may set IPP/TOS or DSCP .
IP Precedence Range	When IPP/DS field is set to IPP/TOS , you need to enter an IP precedence range.
Type of Service	Support services including Normal service, Minimize delay, Maximize throughput, Maximize reliability and Minimize monetary cost .
DSCP Range	DSCP Range is from 0 to 63 .
802.1p	Select this option to Activate/Deactivate the 802.1p. IEEE 802.1p establishes eight levels of priority (0–7). Although network managers must determine actual mappings, IEEE has made broad recommendations. Seven is the highest priority which is usually assigned to network-critical traffic such as Routing Information Protocol (RIP) and Open Shortest Path First (OSPF) table updates. Five and six are often for delay-sensitive applications such as interactive

Field	Description
	video and voice. Data classes four through one range from controlled-load applications such as streaming multimedia and business-critical traffic - carrying SAP data, for instance - down to "loss eligible" traffic. Zero is used as a best-effort default priority, invoked automatically when no other value has been set.
IP Precedence Remarking	For a message matching the QoS rule, its IP precedence value will be modified.
Type of Service Remarking	For a message matching the QoS rule, its type of service value will be modified.
DSCP Remarking	For a message matching the QoS rule, its DSCP value will be modified.
802.1p Remarking	For a message matching the QoS rule, its 802.1P value will be modified.
Queue #	Select Low, Medium, High or Highest .

Click **Save** at the bottom of the page to save the discipline. To view the rules and actions, click **QoS Settings Summary** to enter the page shown in the following figure appears.

EDIMAX
NETWORKING PEOPLE TOGETHER

QoS Settings Summary

Rules									Actions				
#	Active	Physical Ports	Destination		Source		Protocol ID	VLAN ID	IPP/TOS (DSCP)	802.1p	IPP/TOS (DSCP) Remarking	802.1p Remarking	Queue #
			MAC IP/Mask	Port Range	MAC IP/Mask	Port Range							
-	N	-	-	-	-	-	-	-	-	-	-	-	-

e. ethernet, w/wlan, NS: Normal service, MD: Minimize delay, MT: Maximize throughput, MR: Maximize reliability, MC: Minimize monetary cost, HH: Highest, H: High, M: Medium, L: Low.

IP Version: IPv6

Choose **Advanced Setup > QoS**, the page shown in the following figure appears.

The screenshot shows a web-based configuration interface for Quality of Service (QoS). The top navigation bar includes 'Advanced', 'Quick Start', 'Interface Setup', 'Advanced Setup', 'Access Management', 'Maintenance', and 'Status'. Under 'Advanced Setup', there are sub-menus for 'Firewall', 'Routing', 'NAT', 'QoS', 'VLAN', and 'ADSL'. The 'Quality of Service' section is active. On the left, a sidebar lists 'Rule' and 'Action'. The main area contains the following configuration options:

- IP Version: IPv4 IPv6
- QoS: Activated Deactivated
- Summary:
- Rule Index:
- Active: Activated Deactivated
- Destination IPv6:
- Source IPv6:
- DSCP Range: ~ (Value Range: 0 ~ 63)
- DSCP Remarking: (Value Range: 0 ~ 63)
- Queue #:

At the bottom, there are three buttons: , , and .

The following table describes the parameters of this page:

Field	Description
Quality of Service	
IP Version	Select IP version. In this example, the IP version is set to IPv6 .
QoS	Select Activated or Deactivated . After activating QoS, you may set the upload bandwidth of the WAN interface.
Summary	Click the QoS Settings Summary button to view the table of QoS rules and actions.
Rule	
Rule Index	You may establish up to 16 QoS rules.
Active	You may select Activated or Deactivated . Activated must be selected to set QoS rules.
Destination IPv6	The Destination MAC address of the rule. If data packets include the MAC address, the data packets are placed into the group.
Source IPv6	The Source MAC address of the rule. If data packets include the MAC address, the data packets are placed into the group.
DSCP Range	DSCP Range is from 0 to 63 .
DSCP Remarking	For a message matching the QoS rule, its DSCP value will be modified.
Queue #	Select Low , Medium , High or Highest .

Click **Save** at the bottom of the page to save the discipline. To view the rules and actions, click **QoS Settings Summary** to enter the page shown in the following figure appears.



QoS Settings Summary

Rules									Actions		
#	Active	Physical Ports	Destination	Source	Protocol ID	VLAN ID	IPP/TOS (DSCP)	802.1p	IPP/TOS (DSCP) Remarking	802.1p Remarking	Queue #
			MAC IP/Mask Port Range	MAC IP/Mask Port Range							
-	N	-	-	-	-	-	-/-	-	-/-	-	-

e:ethernet, w:wlan, NS: Normal service, MD: Minimize delay, MT: Maximize throughput, MR: Maximize reliability, MC: Minimize monetary cost, HH: Highest, H: High, M: Medium, L: Low.

5.5.5. VLAN

Choose **Advanced Setup > VLAN**, the page shown in the following figure appears.

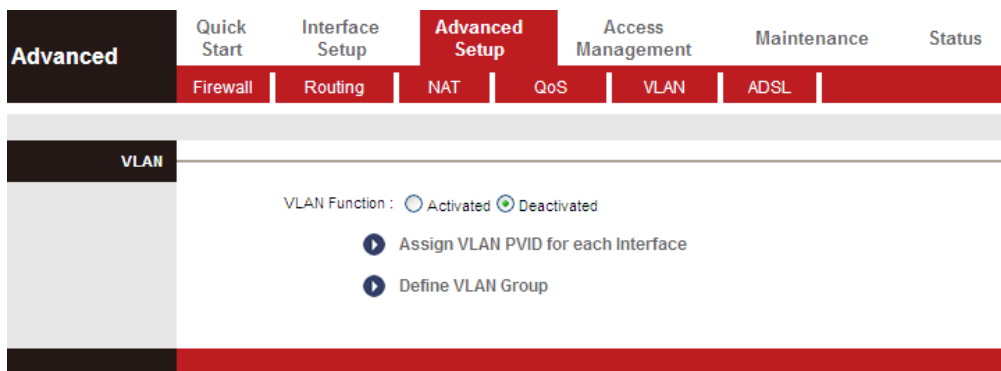

Virtual LAN (VLAN) is a group of devices on one or more LANs that are configured so that they can communicate as if they were attached to the same wire, when in fact they are located on a number of different LAN segments. Because VLANs are based on logical instead of physical connections, it is very flexible for user/host management, bandwidth allocation and resource optimization.

In the **VLAN** page, choose **Activated** and then **Assign VLAN PVID for each Interface**, and the page shown in the following figure appears.

The screenshot shows a web interface for configuring PVID (Port VID) settings. The interface has a top navigation bar with tabs: **Advanced**, Quick Start, Interface Setup, **Advanced Setup**, Access Management, Maintenance, and Status. Under **Advanced Setup**, there are sub-tabs: Firewall, Routing, NAT, QoS, VLAN, ADSL, and an empty tab. The main content area is titled **PVID Assign** and contains three sections of input fields, each separated by a red horizontal line:

- ATM VC #0 : PVID**
- VC #1 : PVID**
- VC #2 : PVID**
- VC #3 : PVID**
- VC #4 : PVID**
- VC #5 : PVID**
- VC #6 : PVID**
- VC #7 : PVID**

Below the first section:

- Ethernet Port #1 : PVID**
- Port #2 : PVID**
- Port #3 : PVID**
- Port #4 : PVID**

Below the second section:

- Wireless LAN : PVID**

At the bottom of the page, there are three buttons: **SAVE**, **CANCEL**, and **NEXT**.

Each physical port has a default VID called PVID (Port VID). PVID is assigned to untagged frames or priority tagged frames (frames with null (0) VID) received on this port. You can set a PVID for an ATM VC, Ethernet port or Wireless LAN.

In the **VLAN** page, choose **Activated** and then **Define VLAN Group**, and the page shown in the following figure appears.

Advanced Setup

VLAN Group Setting

VLAN Index: 1

Active: Yes No

VLAN ID: 1 (Decimal)

ATM VCs:

Tagged	<input type="checkbox"/>	<input type="checkbox"/>	<input type="checkbox"/>	<input type="checkbox"/>	<input type="checkbox"/>	<input type="checkbox"/>	<input type="checkbox"/>
Port #	<input checked="" type="checkbox"/>	<input checked="" type="checkbox"/>	<input checked="" type="checkbox"/>	<input checked="" type="checkbox"/>	<input checked="" type="checkbox"/>	<input checked="" type="checkbox"/>	<input checked="" type="checkbox"/>
	0	1	2	3	4	5	6

Ethernet:

Tagged	<input type="checkbox"/>	<input type="checkbox"/>	<input type="checkbox"/>	<input type="checkbox"/>
Port #	<input checked="" type="checkbox"/>	<input checked="" type="checkbox"/>	<input checked="" type="checkbox"/>	<input checked="" type="checkbox"/>
	1	2	3	4

Wireless LAN:

Tagged	<input type="checkbox"/>
Port #	<input checked="" type="checkbox"/>
	0

VLAN Group Summary

Group	Active	ID	VLAN Group Ports	VLAN Tagged Ports
1	Yes	1	e1,e2,e3,e4,w0,p0,p1,p2,p3,p4,p5,p6,p7	

p:pvc, e:ethernet, and w:wlan

SAVE DELETE CANCEL

The following table describes the parameters of this page:

Field	Description
VLAN Index	Choose a VLAN index from 1 to 8 .
Active	Select Yes or No to specify whether VLAN settings are active or not.
VLAN ID	VLAN ID is from 1 to 4094 .
ATM VCs	Supports eight ATM VCs, which can be tagged.
Ethernet	The Ethernet port can be tagged.
Wireless LAN	You can add a wireless port to the VLAN group.

5.5.6. ADSL

Click **Advanced Setup** > **ADSL**, the page shown in the following figure appears. The ADSL feature can be selected when you meet the physical connection problem. Please check the proper settings with your Internet service provider.

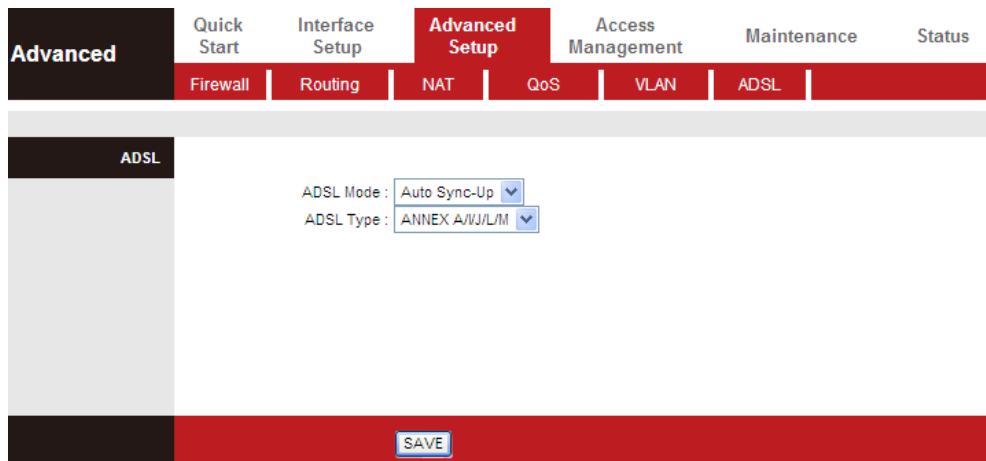

The router supports these modulations: **G.Lite**, **T1.413**, **G.DMT**, **ADSL2**, **ADSL2+** and **Auto-Syno Up**. The router negotiates the modulation modes with the DSLAM.

The following table describes the parameters and buttons of this page:

Field	Description
ADSL Mode	Choose Auto Sync-Up , ADSL2+ , ADSL2 , G.DMT , T1.413 or G.lite . The default is Auto Sync-Up .
ADSL Type	Choose ANNEX A , ANNEX I , ANNEX A/L , ANNEX M or ANNEX A/I/J/L/M .

5.6. Access Management

In the navigation bar, click **Access Management**. The **Access Management** page that is displayed contains **ACL**, **Filter**, **SNMP**, **UPnP**, **DDNS** and **CWMP**.

5.6.1. ACL

Choose **Access Management** > **ACL**, and the page shown in the following figure appears. The user may remotely access the ADSL Router once his IP has been set as a Secure IP Address through selected applications. With the default IP 0.0.0.0, any client would be allowed to remotely access the ADSL Router.

The following table describes the parameters and buttons of this page:

Field	Description
ACL Rule Index	You can establish sixteen ACL rules at most.
Active	Click to enable or disable the rule.
Secure IP Address	The rule is valid if the IP is in this range.
Application	Support Web, FTP, Telnet, SNMP, Ping or ALL .
Interface	Support WAN, LAN or Both .
Access control Listing	Only the devices whose MAC addresses are listed in the Access Control Listing can access the router.

5.6.2. Filter

Choose **Access Management > Filter**, and the page shown in the following figure appears. Select IP/MAC Filter type. The user can set IP/MAC Filter, Application Filter and URL Filter.

5.6.2.1. IP/MAC Filter

Choose **Access Management > Filter**, select **IP/MAC Filter** from the drop-down list **Filter Type Selection**, and the page shown in the following figure appears. The user can set different IP filter rules of a given protocol (TCP, UDP or ICMP) and a specific direction (incoming, outgoing, or both) to filter the packets.

Access Management | Quick Start | Interface Setup | Advanced Setup | **Access Management** | Maintenance | Status

ACL | Filter | SNMP | UPnP | DDNS | CWMP

Filter

Filter Type

Filter Type Selection: IP / MAC Filter

IP / MAC Filter Set Editing

IP / MAC Filter Set Index: 1
Interface: PVC0
Direction: Both

IP / MAC Filter Rule Editing

IP / MAC Filter Rule Index: 1
Rule Type: IP
Active: Yes No

Source IP Address: (0.0.0.0 means Don't care)
Subnet Mask:
Port Number: 0 (0 means Don't care)

Destination IP Address: (0.0.0.0 means Don't care)
Subnet Mask:
Port Number: 0 (0 means Don't care)

Protocol: TCP
Rule Unmatched: Forward

IP / MAC Filter Listing

IP / MAC Filter Set Index		Interface		Direction			
#	Active	Src Address/Mask	Dest IP/Mask	Src Port	Dest Port	Protocol	Unmatched
1	-	-	-	-	-	-	-
2	-	-	-	-	-	-	-
3	-	-	-	-	-	-	-
4	-	-	-	-	-	-	-
5	-	-	-	-	-	-	-
6	-	-	-	-	-	-	-

SAVE DELETE CANCEL

The following table describes the parameters and buttons of this page:

Field	Description
Filter Type Selection	Support IP / MAC Filter , Application Filter and URL Filter .
IP/MAC Filter Set Index	You can choose an IP / MAC Filter Set Index from 1 to 12 .
Interface	You can select an interface from the eight PVCs or the LAN interface.
Direction	Choose Both , Incoming or Outgoing .
Rule Type	Select IP or MAC .
Source IP Address	Enter the Source IP Address.
Port Number	Enter the Port Number. 0 means don't care.
Destination IP Address	Enter the Destination IP Address.
Protocol	Support TCP , UDP or ICMP .

5.6.2.2. Application Filter

Choose **Access Management > Filter**, select **Application Filter** from the drop-down list **Filter Type Selection**, and the page shown in the following figure appears. Select Application Filter type. The user can set Application rules to filter the ICQ, MSN, YMSG, Real Audio/Video packets.

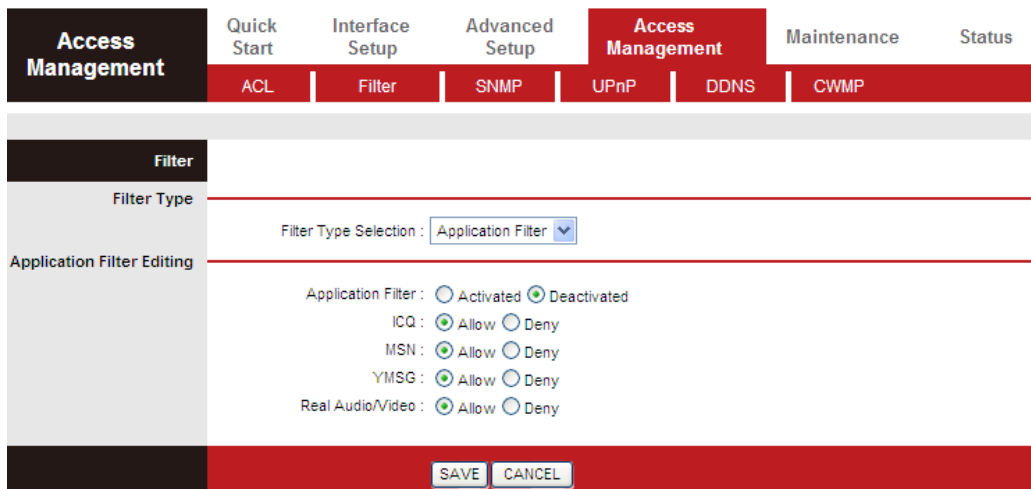

The following table describes the parameters and buttons of this page:

Field	Description
Active	Choose to activate or deactivate the Application Filter rule.
ICQ	Set Allow or Deny ICQ packets.
MSN	Set Allow or Deny MSN packets.
YMSG	Set Allow or Deny YMSG packets.
Real Audio/Video	Set Allow or Deny Real Audio/Video packets.

5.6.2.3. URL Filter

Choose **Access Management > Filter**, select **URL Filter** from the drop-down list **Filter Type Selection**, and the page shown in the following figure appears. Select URL Filter type. The user can set URL rules to prevent the LAN users to access.

Access Management | Quick Start | Interface Setup | Advanced Setup | **Access Management** | Maintenance | Status

ACL | Filter | SNMP | UPnP | DDNS | CWMP

Filter

Filter Type

Filter Type Selection: URL Filter

URL Filter Editing

Active: Yes No

URL Index: 1

URL:

URL Filter Listing

Index	URL
1	
2	
3	
4	
5	
6	
7	
8	
9	
10	
11	
12	
13	
14	
15	
16	

SAVE DELETE CANCEL

The following table describes the parameters and buttons of this page:

Field	Description
Active	Make URL Filter rule activated or deactivated.
URL Index	Can set an URL Filter Index from 1 to 16.
URL	Enter the URL that needs to be filtered.

5.6.3. SNMP

Choose **Access Management > SNMP**, and the page shown in the following figure appears. The SNMP (Simple Network Management Protocol) is used for exchanging information between network devices.

Access Management | Quick Start | Interface Setup | Advanced Setup | **Access Management** | Maintenance | Status

ACL | Filter | SNMP | UPnP | DDNS | CWMP

SNMP

Get Community: public

Set Community: public

SAVE

The following table describes the parameters of this page:

Field	Description
Get Community	Select to set the password for the incoming Get- and GetNext requests from the management station.
Set Community	Select to set the password for incoming Set requests from the management station.

5.6.4. UPnP

Choose **Access Management > UPnP**, the page shown in the following figure appears. This page is used to configure the UPnP parameters.

UPnP (Universal Plug and Play) is a distributed, open networking standard that uses TCP/IP for simple peer-to-peer network connectivity between devices. An UPnP device can dynamically join a network, obtain an IP address, convey its capabilities and learn about other devices on the network. In turn, a device can leave a network smoothly and automatically when it is no longer in use. UPnP broadcasts are only allowed on the LAN.

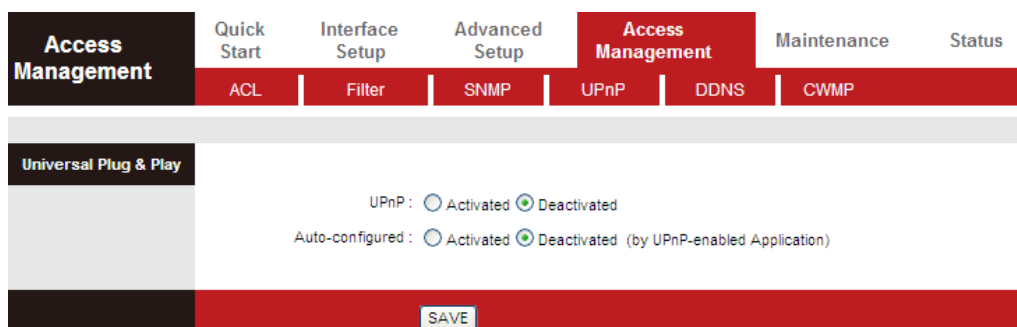

The following table describes the parameters of this page:

Field	Description
UPnP	You can choose Activated or Deactivated .
Auto-configured	UPnP network devices can automatically configure network addressing, announce their presence in the network to other UPnP devices and enable exchange of simple product and service descriptions.

5.6.5. DDNS

Choose **Access Management > DDNS**, the page shown in the following figure appears.

The Dynamic Domain Name System (DDNS) lets you use a static host name with a dynamic IP address. User should type the host name, user name and password assigned to your ADSL Router by your Dynamic DNS provider. The user also can decide to turn on DYNDNS Wildcard or not.

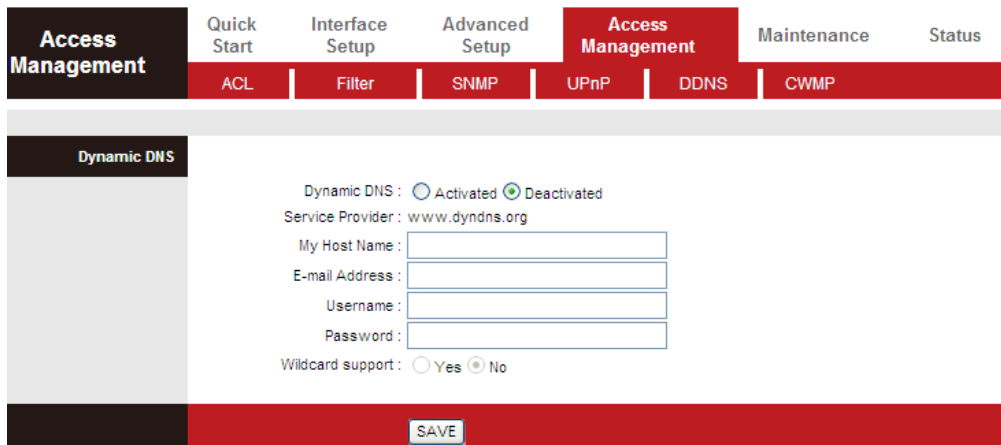

The following table describes the parameters of this page:

Field	Description
Dynamic DNS	Choose to activate or deactivate DDNS function.
My Host Name	The DDNS identifier
E-mail Address	The email provided by DDNS provider
Username	The name provided by DDNS provider
Password	The password provided by DDNS provider
Wildcard support	You can choose Yes or No.

5.6.6. CWMP

Choose **Access Management > CWMP**, and the page shown in the following figure appears.

The following table describes the parameters of this page:

Field	Description
URL	URL for the CPE to connect to the ACS using the CPE WAN Management Protocol. This parameter must be in the form of a valid http or https URL.
User Name	Username used to authenticate the CPE when making a connection to the ACS using the CPE WAN Management Protocol.
Password	Password used to authenticate the CPE when making a connection to the ACS using the CPE WAN Management Protocol.
User Name	CPE's username, the connection username provided by TR-069 service
Password	CPE's password, the connection password provided by TR-069 service for a connection request to the CPE.
Periodic Inform	Select Activated to periodically connect to the ACS to check for configuration updates.
Interval(s)	Specify the duration between two connections to ACS.

5.7. Maintenance

In the navigation bar, click **Maintenance**. The **Maintenance** page that is displayed contains **Administration**, **Time Zone**, **Firmware**, **SysRestart** and **Diagnostics**.

5.7.1. Administration

Choose **Maintenance > Administration**, the page shown in the following figure appears. There is only one account that can access the Web-Management interface. The default account is "admin" and the password is "admin" – the "admin" account has read/write access privilege. In this web page, you can set new a password for "admin".

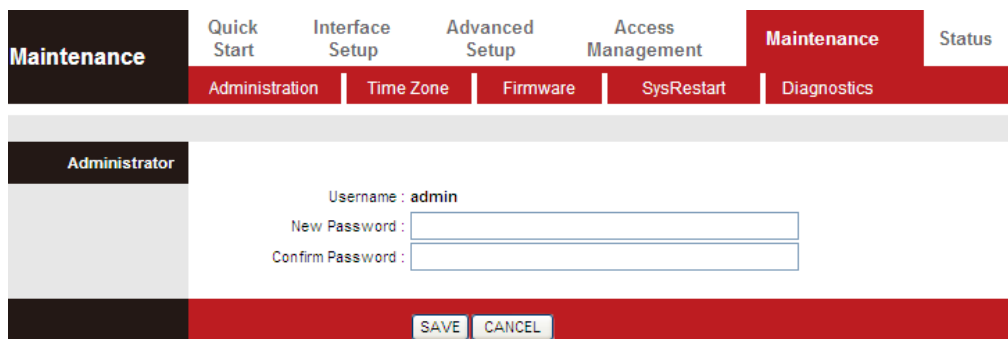

The screenshot shows a web interface with a navigation bar at the top. The navigation bar has a dark red background with white text. The main menu items are: Maintenance (highlighted in dark red), Quick Start, Interface Setup, Advanced Setup, Access Management, and Status. Below the main menu, there is a sub-menu with a red background and white text: Administration (highlighted), Time Zone, Firmware, SysRestart, and Diagnostics. The main content area has a light gray background. On the left, there is a dark red sidebar with the word "Administrator" in white. The main content area contains the following form:

Username : admin

New Password :

Confirm Password :

At the bottom of the form, there are two buttons: "SAVE" and "CANCEL".

The following table describes the parameters of this page:

Field	Description
New Password	Enter the password to which you want to change the old password.
Confirm Password	Enter the new password again.

5.7.2. Time Zone

Choose **Maintenance > Time Zone**, the page shown in the following figure appears.

The system time is the time used by the device for scheduling services. You can manually set the time or connect to a NTP (Network Time Protocol) server. If a NTP server is set, you will only need to set the time zone. If you manually set the time, you may also set Daylight Saving dates and the system time will automatically adjust on those dates.

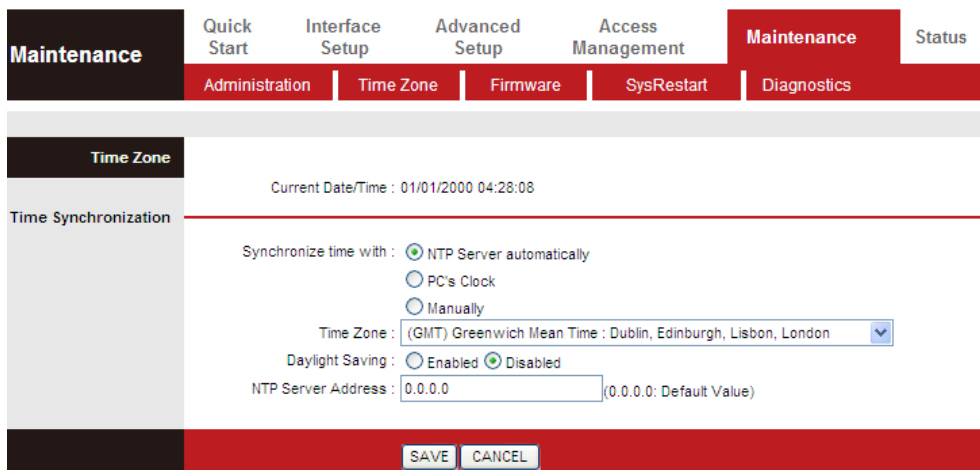

The following table describes the parameters of this page:

Field	Description
Synchronize time with	You can choose NTP Server automatically, PC's Clock or Manually.
Time Zone	Choose the time zone in which area you are from the drop-down list.
Daylight Saving	You can enable the daylight saving time.
NTP Server Address	Set the NTP server manually.

5.7.3. Firmware

Choose **Maintenance > Firmware**, the page shown in the following figure appears.

You can upgrade the firmware of the Router in this page. Make sure the firmware you want to use is on the local hard drive of the computer. Click on **Browse** to browse the local hard drive and locate the firmware to be used for upgrade.

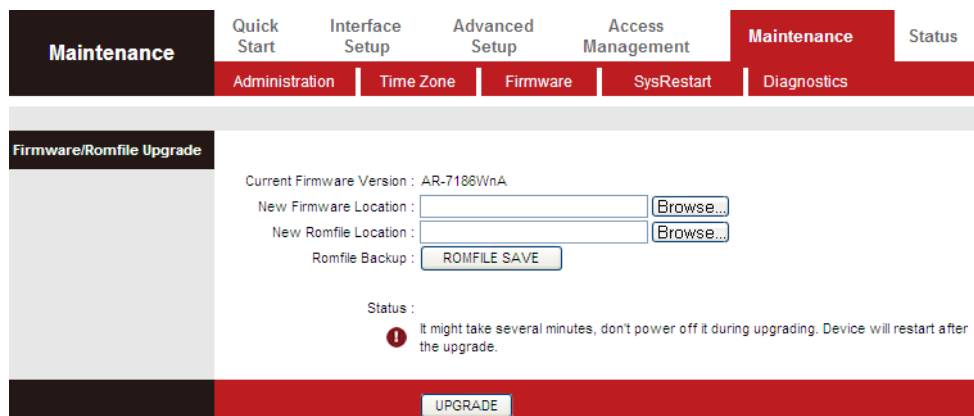

The following table describes the parameters of this page:

Field	Description
New Firmware Location	Click Browse to select the firmware file.
Romfile Backup	Click Browse and select a path to save the configuration file of the router.
UPGRADE	After selecting the file, click UPGRADE to starting upgrading the file.

5.7.4. SysRestart

Choose **Maintenance > SysRestart**, the page shown in the following figure appears. You can restart the device with current settings or back to factory default settings.

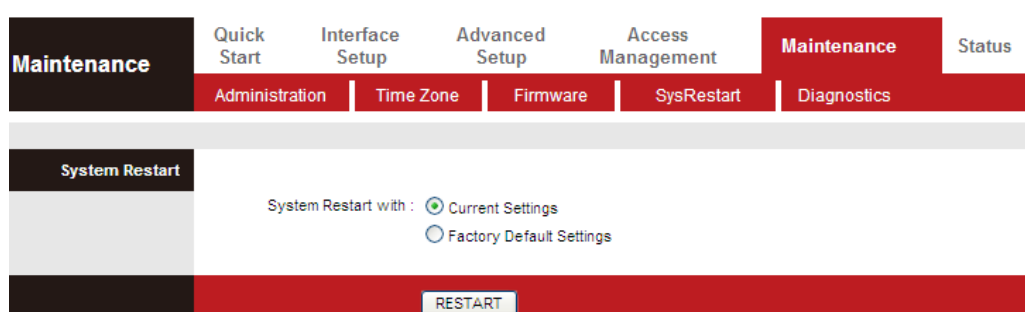

The following table describes the parameters of this page:

Field	Description
Current Settings	Restart the router with current settings.
Factory Default Settings	Restart the router with settings reset back to factory defaults.

5.7.5. Diagnostics

Choose **Maintenance > Diagnostics**, the page shown in the following figure appears. The page shows the test results for the connectivity of the physical layer and protocol layer for both LAN and WAN sides.

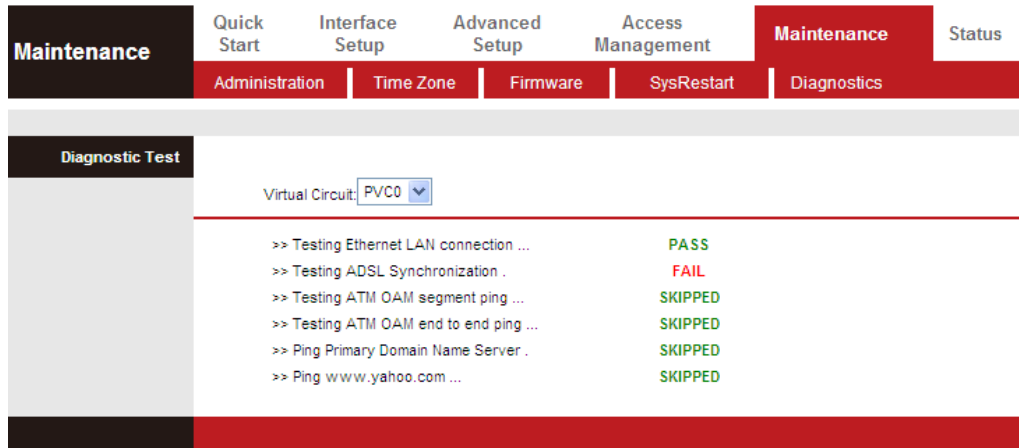

The following table describes the parameters of this page:

Field	Description
Virtual Circuit	Choose a PVC from the drop down list to test.

6. Trouble Shooting

Question	Answer
Why are all the indicators off?	<ul style="list-style-type: none">• Check the connection between the power adapter and the power socket.• Check whether the power switch is turned on.
Why is the LAN indicator off?	<ul style="list-style-type: none">• Check the connection between the device and your PC, hub or switch.• Check the running status of the computer, hub, or switch.
Why is the ADSL indicator off?	Check the connection between the Line port of the device and the wall jack.
Why does Internet access fail while the ADSL indicator is on?	Check whether the VPI, VCI, user name and password are correctly entered.
Why can I not access the web configuration page of the DSL router?	Choose Start > Run from the desktop, and ping 192.168.2.1 (IP address of the DSL router). If the DSL router is not reachable, check the type of network cable, the connection between the DSL router and the PC, and the TCP/IP configuration of the PC.
How to load the default settings after incorrect configuration?	To restore the factory default settings, turn on the device, and press the reset button for about 3 seconds, and then release it. The default IP address and the subnet mask of the DSL router are 192.168.2.1 and 255.255.255.0 , respectively. <ul style="list-style-type: none">• User/password of super user: admin/1234• User/password of common user: user/user

EU Declaration of Conformity

- English:** This equipment is in compliance with the essential requirements and other relevant provisions of Directive 1999/5/EC, 2009/125/EC.
- French:** Cet équipement est conforme aux exigences essentielles et autres dispositions de la directive 1999/5/CE, 2009/125/CE
- Czechian:** Toto zařízení je v souladu se základními požadavky a ostatními příslušnými ustanoveními směrnic 1999/5/ES, 2009/125/ES.
- Polish:** Urządzenie jest zgodne z ogólnymi wymaganiami oraz szczególnymi warunkami określonymi Dyrektywą UE 1999/5/EC, 2009/125/EC
- Romanian:** Acest echipament este în conformitate cu cerințele esențiale și alte prevederi relevante ale Directivei 1999/5/CE, 2009/125/CE.
- Russian:** Это оборудование соответствует основным требованиям и положениям Директивы 1999/5/EC, 2009/125/EC.
- Magyar:** Ez a berendezés megfelel az alapvető követelményeknek és más vonatkozó irányelveknek (1999/5/EK, 2009/125/EC)
- Türkçe:** Bu cihaz 1999/5/EC, 2009/125/EC direktifleri zorunlu istekler ve diğer hükümlerle ile uyumludur.
- Ukrainian:** Обладнання відповідає вимогам і умовам директиви 1999/5/EC, 2009/125/EC.
- Slovakian:** Toto zariadenie spĺňa základné požiadavky a ďalšie príslušné ustanovenia smerníc 1999/5/ES, 2009/125/ES.
- German:** Dieses Gerät erfüllt die Voraussetzungen gemäß den Richtlinien 1999/5/EC, 2009/125/EC.
- Spanish:** El presente equipo cumple los requisitos esenciales de la Directiva 1999/5/EC, 2009/125/EC.
- Italian:** Questo apparecchio è conforme ai requisiti essenziali e alle altre disposizioni applicabili della Direttiva 1999/5/CE, 2009/125/CE.
- Dutch:** Dit apparaat voldoet aan de essentiële eisen en andere van toepassing zijnde bepalingen van richtlijn 1999/5/EC, 2009/125/EC.
- Portuguese:** Este equipamento cumpre os requisitos essenciais da Directiva 1999/5/EC, 2009/125/EC
- Norwegian:** Dette utstyret er i samsvar med de viktigste kravene og andre relevante regler i Direktiv 1999/5/EC, 2009/125/EC.
- Swedish:** Denna utrustning är i överensstämmelse med de väsentliga kraven och övriga relevanta bestämmelser i direktiv 1999/5/EG, 2009/125/EG.
- Danish:** Dette udstyr er i overensstemmelse med de væsentligste krav og andre relevante forordninger i direktiv 1999/5/EC, 2009/125/EC.
- Finnish:** Tämä laite täyttää direktiivien 1999/5/EY, 2009/125/EY oleelliset vaatimukset ja muut asiaankuuluvat määräykset.

FOR USE IN

AT	BE	CY	CZ	DK	EE	FI	FR	RU				
DE	GR	HU	IE	IT	LV	LT	LU	MT	NL	PL	PT	UA
SK	SI	ES	SE	GB	IS	LI	NO	CH	BG	RO	TR	



WEEE Directive & Product Disposal



At the end of its serviceable life, this product should not be treated as household or general waste. It should be handed over to the applicable collection point for the recycling of electrical and electronic equipment, or returned to the supplier for disposal.

Declaration of Conformity

We, Edimax Technology Co., LTD., declare under our sole responsibility, that the equipment described below complies with the requirements of the European Council directive (1995/5/EC, 2006/95/EC , EC/1275/2008).

Equipment : N300 Wireless ADSL Modem Router
Model No. : AR-7286WnA & AR-7286WnB

The following European standards for essential requirements have been followed:

Spectrum : ETSI EN 300 328 : V1.7.1(2006-10)
EMC : EN 301 489-1 V1.9.2(2011-09)
EN 301 489-17 V2.2.1(2012-09)
EMF : EN 62311 : 2008
Safety : IEC 60950-1 :
(LVD) 2005 (2ndEdition)+A1 :2009
EN 60950-1 :
2006+A11:2009+A1:2010+A12:2011
Eco-design : EN 50564:2011

Edimax Technology Co., Ltd.
No. 3, Wu Chuan 3rd Road,
Wu-Ku Industrial Park.
New Taipei City, Taiwan



Date of Signature:

June, 2013

Signature:

A handwritten signature in black ink, appearing to read 'Albert Chang', written over a white background.

Printed Name:

Albert Chang

Title:

: Director
Edimax Technology Co., Ltd.



Edimax Technology Co., Ltd.
No.3, Wu-Chuan 3rd Road, Wu-Gu,
New Taipei City 24891, Taiwan

Edimax Technology Europe B.V.
Nijverheidsweg 25 5683 CJ Best
The Netherlands

Edimax Computer Company
3350 Scott Blvd., Bldg.15 Santa Clara,
CA 95054, USA