



TP-LINK[®]

User Guide

TL-WR641G

108M Wireless Router



- 108Mbps Super G[™]
- 2x to 3x eXtended Range[™]
- 2.4GHz • 802.11g/b

Rev: 1.0.2

1910010066

COPYRIGHT & TRADEMARKS

Specifications are subject to change without notice. **TP-LINK**[®] is a registered trademark of TP-LINK TECHNOLOGIES CO., LTD. Other brands and product names are trademarks or registered trademarks of their respective holders.

No part of the specifications may be reproduced in any form or by any means or used to make any derivative such as translation, transformation, or adaptation without permission from TP-LINK TECHNOLOGIES CO., LTD. Copyright © 2008 TP-LINK TECHNOLOGIES CO., LTD.

All rights reserved.

FCC STATEMENT



This equipment has been tested and found to comply with the limits for a Class B digital device, pursuant to part 15 of the FCC Rules. These limits are designed to provide reasonable protection against harmful interference in a residential installation. This equipment generates, uses and can radiate radio frequency energy and, if not installed and used in accordance with the instructions, may cause harmful interference to radio communications. However, there is no guarantee that interference will not occur in a particular installation. If this equipment does cause harmful interference to radio or television reception, which can be determined by turning the equipment off and on, the user is encouraged to try to correct the interference by one or more of the following measures:

- Reorient or relocate the receiving antenna.
- Increase the separation between the equipment and receiver.
- Connect the equipment into an outlet on a circuit different from that to which the receiver is connected.
- Consult the dealer or an experienced radio/ TV technician for help.

This device complies with part 15 of the FCC Rules. Operation is subject to the following two conditions:

- 1) This device may not cause harmful interference.
- 2) This device must accept any interference received, including interference that may cause undesired operation.

FCC RF Radiation Exposure Statement

This equipment complies with FCC RF radiation exposure limits set forth for an uncontrolled environment. This device and its antenna must not be co-located or operating in conjunction with any other antenna or transmitter.

“To comply with FCC RF exposure compliance requirements, this grant is applicable to only Mobile Configurations. The antennas used for this transmitter must be installed to provide a separation distance of at least 20 cm from all persons and must not be co-located or operating in conjunction with any other antenna or transmitter.”

CE Mark Warning



This is a class B product. In a domestic environment, this product may cause radio interference, in which case the user may be required to take adequate measures.

National Restrictions

2400.0-2483.5 MHz

Country	Restriction	Reason/remark
Bulgaria		General authorization required for outdoor use and public service
France	Outdoor use limited to 10 mW e.i.r.p. within the band 2454-2483.5 MHz	Military Radiolocation use. Refarming of the 2.4 GHz band has been ongoing in recent years to allow current relaxed regulation. Full implementation planned 2012
Italy		If used outside of own premises, general authorization is required
Luxembourg	None	General authorization required for network and service supply(not for spectrum)
Norway	Implemented	This subsection does not apply for the geographical area within a radius of 20 km from the centre of Ny-Ålesund
Russian Federation		Only for indoor applications

Note: It's not used outdoors in France.

TP-LINK®

DECLARATION OF CONFORMITY

For the following equipment:
Product Description: **108M Wireless Router**
Model No.: **TL-WR641G/TL-WR642G**
Trademark: **TP-LINK**

We declare under our own responsibility that the above products satisfy all the technical regulations applicable to the product within the scope of Council Directives:

Directives 1999/5/EC

The above product is in conformity with the following standards or other normative documents

ETSI EN 300 328 V1.6.1: 2004
ETSI EN 301 489-17 V1.2.1: 2002
EN 61000-3-2:2000
EN 61000-3-3:1995+A1:2001
EN60950-1:2001
EN50371:2002

Person is responsible for marking this declaration:

For and on behalf of
TP-LINK TECHNOLOGIES CO.,LTD.

Zhao Jian Jun

Authorized Signature(s)

Director of International Business

Date of Issue: **24-3-2007**

TP-LINK TECHNOLOGIES CO., LTD.

**ADD: Building 7, Second Part, Honghualing Industrial Zone,
Xili town, Nanshan District, Shenzhen, China**

Website: www.tp-link.com



Package contents

The following contents should be found in your box:

- One TL-WR641G 108Mbps Wireless Router
- One AC power Adapter for TL-WR641G 108Mbps Wireless Router
- One Quick Installation Guide
- One Resource CD for TL-WR641G 108Mbps Wireless Router, including:
 - This Guide
 - Other Helpful Information

Note:

Make sure that the package contains the above items. If any of the listed items are damaged or missing, please contact with your distributor.

Conventions

The router or TL-WR641G mentioned in this guide stands for TL-WR641G 108Mbps Wireless Router without any explanation.

CONTENTS

Chapter 1. Introduction	1
1.1 Overview of the Router	1
1.2 Features	1
1.3 Panel Layout	2
1.3.1 The Front Panel.....	2
1.3.2 The Rear Panel	3
Chapter 2. Connecting the Router	5
2.1 System Requirements	5
2.2 Installation Environment Requirements	5
2.3 Connecting the Router	5
Chapter 3. Quick Installation Guide	7
3.1 TCP/IP configuration	7
3.2 Quick Installation Guide	9
Chapter 4. Configuring the Router.....	13
4.1 Login	13
4.2 Status.....	13
4.3 Quick Setup.....	14
4.4 Network	15
4.4.1 LAN	15
4.4.2 WAN.....	15
4.4.3 MAC Clone	26
4.5 Wireless	27
4.5.1 Wireless Settings	27
4.5.2 MAC Filtering	32
4.5.3 Wireless Statistics	35
4.6 DHCP.....	36
4.6.1 DHCP Settings.....	36
4.6.2 DHCP Clients List	37
4.6.3 Address Reservation	37
4.7 Forwarding.....	39
4.7.1 Virtual Servers	39
4.7.2 Port Triggering	41
4.7.3 DMZ	43
4.7.4 UPnP	43

4.8	Security	44
4.8.1	Firewall	44
4.8.2	IP Address Filtering	45
4.8.3	Domain Filtering	47
4.8.4	MAC Filtering	49
4.8.5	Remote Management	51
4.8.6	Advanced Security	51
4.9	IP & MAC Binding Setting	53
4.9.1	Binding Setting	53
4.9.2	ARP List	55
4.10	Static Routing	56
4.11	DDNS	57
4.11.1	Dyndns.org DDNS	57
4.11.2	Oray.net DDNS	58
4.11.3	Comexe.cn DDNS	58
4.12	System Tools	59
4.12.1	Time	60
4.12.2	Firmware	61
4.12.3	Factory Defaults	61
4.12.4	Backup and Restore	62
4.12.5	Reboot	62
4.12.6	Password	63
4.12.7	Log	63
4.12.8	Statistics	64
Appendix A: FAQ		66
Appendix B: Configuring the PC		70
Appendix C: Specifications		74
Appendix D: Glossary		75

Chapter 1. Introduction

Thank you for choosing TL-WR641G 108Mbps Wireless Router.

1.1 Overview of the Router

The TL-WR641G 108Mbps Wireless Router integrates 4-port Switch, Firewall, NAT-router and Wireless AP. Its design is dedicated to Small Office/Home Office (SOHO) wireless network solutions. The TL-WR641G 108Mbps Wireless Router will allow you to connect your network wirelessly better than ever, sharing Internet Access, files and fun, easily and securely.

In the most attentive wireless security, the TL-WR641G 108Mbps Wireless Router provides multiple protection measures. It can be set to turn off the wireless network name (SSID) broadcast so that only stations that have the SSID can be connected. The router provides wireless LAN 64/128/152-bit WEP encryption security, and WPA/WPA2 and WPA-PSK/WPA2-PSK authentication, as well as TKIP/AES encryption security. It also supports VPN Pass-through for sensitive data secure transmission.

The TL-WR641G 108Mbps Wireless Router complies with the IEEE 802.11g and IEEE 802.11b standards and adopts **108M Super G™ WLAN transmission technology** so that the data transmission rate is up to 108Mbps. It adopts **2x to 3x eXtended Range™ WLAN transmission technology** so that transmission distance is 2-3 times that of traditional IEEE 802.11g and IEEE 802.11b solutions, up to a distance of 855.36m tested in China. Transmission range is extended to 4-9 times. It is compatible with all IEEE 802.11g and IEEE 802.11b products.

The TL-WR641G 108Mbps Wireless Router provides flexible access control so that parents or network administrators can establish restricted access policies for children or staff. It has built-in NAT and DHCP server supporting static IP address distributing. It also supports Virtual Server and DMZ host for Port Triggering needs, and remote management and log so that network administrators can manage and monitor the network in real time. This device supports Bridge mode which can make two APs communicate with each other wirelessly.

The TL-WR641G 108Mbps Wireless Router is easy-to-manage. Quick Setup is supported and friendly help messages are provided for every step. So you can configure it quickly and share Internet access, files and fun.

1.2 Features

- Complies with IEEE 802.11g, IEEE 802.11b, IEEE 802.3, IEEE 802.3u standards.
- 1 10/100M Auto-Negotiation RJ45 WAN port, 4 10/100M Auto-Negotiation RJ45 LAN ports, supporting Auto MDI/MDIX.
- Adopts 2x to 3x eXtended Range™ and 108M Super G™ wireless LAN transmission

technology.

- Supports 108/54/48/36/24/18/12/9/6Mbps or 11/5.5/3/2/1Mbps data transfer rates.
- Provides WPA/WPA2, WPA-PSK/WPA2-PSK authentication, TKIP/AES encryption security.
- Shares data and Internet access for users, supporting PPPoE, Dynamic IP, Static IP, L2TP, PPTP, BigPond Cable Internet access.
- Supports Virtual Server, Special Application and DMZ host.
- Supports UPnP, Dynamic DNS, Static Routing, VPN Pass-through.
- Connecting Internet on demand and disconnecting from the Internet when idle for PPPoE.
- Built-in NAT and DHCP server supporting static IP address distributing.
- Built-in firewall supporting IP address filtering, Domain Name filtering, and MAC address filtering.
- Supports connecting/disconnecting from the Internet on a specified time of day.
- Supports access control, parents and network administrators can establish restricted access policies based on time of day for children or staff.
- Provides 64/128/152-bit WEP encryption security and wireless LAN ACL (Access Control List).
- Supports Flow Statistics.
- Supports ICMP-FLOOD, UDP-FLOOD, and TCP-SYN-FLOOD filter.
- Ignores Ping packets from WAN or LAN ports.
- Supports firmware upgrade.
- Supports Web management.

1.3 Panel Layout

1.3.1 The Front Panel

The front panel of the TL-WR641G consists of several LED indicators, which is designed to indicate connections. View from left to right, the next table describes the LEDs on the front panel of the router.



Figure 1-1

LEDs description:

Name	Status	Indication
PWR	Off	Power off
	On	Power on
SYS	On	The router is initializing
	Flashing	The router is working properly
	Off	The router has a hardware error
WLAN	Off	There is no wireless device linked to the router
	Flashing	The Wireless function is enabled
WAN,1-4	Off	There is no device linked to the corresponding port
	On	There is a device linked to the corresponding port but no activity
	Flashing	There is an active device linked to the corresponding port

1.3.2 The Rear Panel

The following parts are located on the rear panel (View from left to right):

- **AC power socket:** Please use the power adapter which is supplied with the TL-WR641G 108Mbps Wireless Router only, the use of a different adapter may result in product damage.
- **LAN 1,2,3,4:** Four 10/100Mbps RJ45 LAN ports for connecting the router to the local PC(s)

- **WAN:** This WAN port is where you will connect the cable/DSL Modem, or Ethernet

- **Reset button:**

There are two ways to reset the router's factory defaults:

- 1) Use the **Factory Defaults** function on **System Tools -> Factory Defaults** page in the router's Web-based Utility.
- 2) Use the Factory Default Reset button: First, turn off the router's power. Second, press and hold the default reset button then turn on the router's power, until the SYS LED lights up (about 3 seconds). Last, release the reset button and wait for the router to reboot.

👉 **Note:** Ensure the router is powered on before it restarts completely.

- **Wireless antenna**

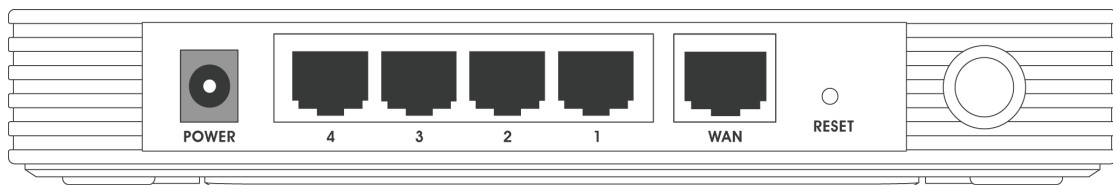

Figure 1-2

Chapter 2. Connecting the Router

2.1 System Requirements

- Broadband Internet Access Service (DSL/Cable/Ethernet)
- One DSL/Cable Modem that has an RJ45 connector (you do not need it if you connect the router to the Ethernet)
- Each PC in the LAN needs a working Ethernet Adapter and an Ethernet cable with RJ45 connectors
- TCP/IP protocol must be installed on each PC
- Web browser, such as Microsoft Internet Explorer 5.0 or later, Netscape Navigator 6.0 or later

2.2 Installation Environment Requirements

- Do not place in direct sunlight or near a heater or heating vent
- Do not cluttered or crowded. There should be at least 2 inches (5 cm) of clear space on all sides of the router
- Well ventilated (especially if it is in a closet)
- Operating temperature: 0°C~40°C (32°F~104°F)
- Operating Humidity: 10%~90%RH, Non-condensing

2.3 Connecting the Router

Before you install the router, you should connect your PC to the Internet through your broadband service successfully. If there is any problem, please contact your ISP. After that, please install the router according to the following steps. Don't forget to pull out the power plug and keep your hands dry.

1. Power off your PC, Cable/DSL Modem, and the router.
2. Locate an optimum location for the router. The best place is usually near the center of the area in which your PC will connect wirelessly. The place must accord with the [Installation Environment Requirements](#).
3. Adjust the direction of the antenna. Normally, upright is a good direction.
4. Connect the PC(s) and each Switch/Hub in your LAN to the LAN Ports on the router, shown in Figure 2-1. (If you have the wireless NIC and want to use wireless function, you can skip this step.)
5. Connect the DSL/Cable Modem to the WAN port on the router, shown in Figure 2-1.
6. Connect the AC power adapter to the AC power socket on the router, and the other end into an electrical outlet. The router will start to work automatically.

7. Power on your PC and Cable/DSL Modem.

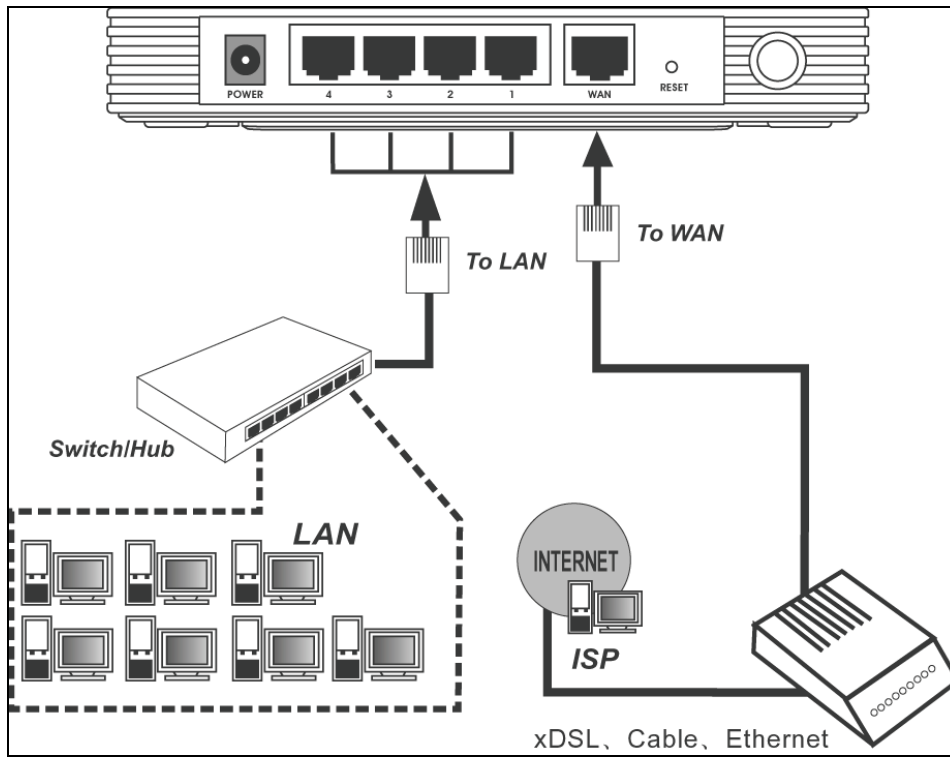

Figure 2-1

Chapter 3. Quick Installation Guide

After connecting the TL-WR641G Router into your network, you should configure it. This chapter describes how to configure the basic functions of your TL-WR641G Wireless Router. These procedures only take you a few minutes. You can access the Internet via the router immediately after successfully configuring.

3.1 TCP/IP configuration

The default IP address of the TL-WR641G 108Mbps Wireless Router is 192.168.1.1. And the default Subnet Mask is 255.255.255.0. These values can be seen from the LAN. They can be changed as you desire, as an example we use the default values for description in this guide.

Connect the local PC to the LAN ports of the router. There are then two ways to configure the IP address for your PC.

- Configure the IP address manually
 - 1) Set up the TCP/IP Protocol for your PC. If you need instructions as to how to do this, please refer to [Appendix B: "Configuring the PC."](#)
 - 2) Configure the network parameters. The IP address is 192.168.1.xxx ("xxx" is from 2 to 254), Subnet Mask is 255.255.255.0, and Gateway is 192.168.1.1 (The router's default IP address)
- Obtain an IP address automatically
 - 1) Set up the TCP/IP Protocol in "**Obtain an IP address automatically**" mode on your PC. If you need instructions as to how to do this, please refer to [Appendix B: "Configuring the PC."](#)
 - 2) Power off the router and PC. Then turn on the router and restart the PC. The built-in DHCP server will assign IP address for the PC.

 **Note:** For Windows 98 OS or earlier, the PC and router may need to be restarted.

Now, you can run the Ping command in the **command prompt** to verify the network connection between your PC and the router. The following example is in Windows 2000.

Open a command prompt, and type *ping 192.168.1.1*, and then press **Enter**.

If the result displayed is similar to that shown in Figure 3-1, the connection between your PC and the router has been established.

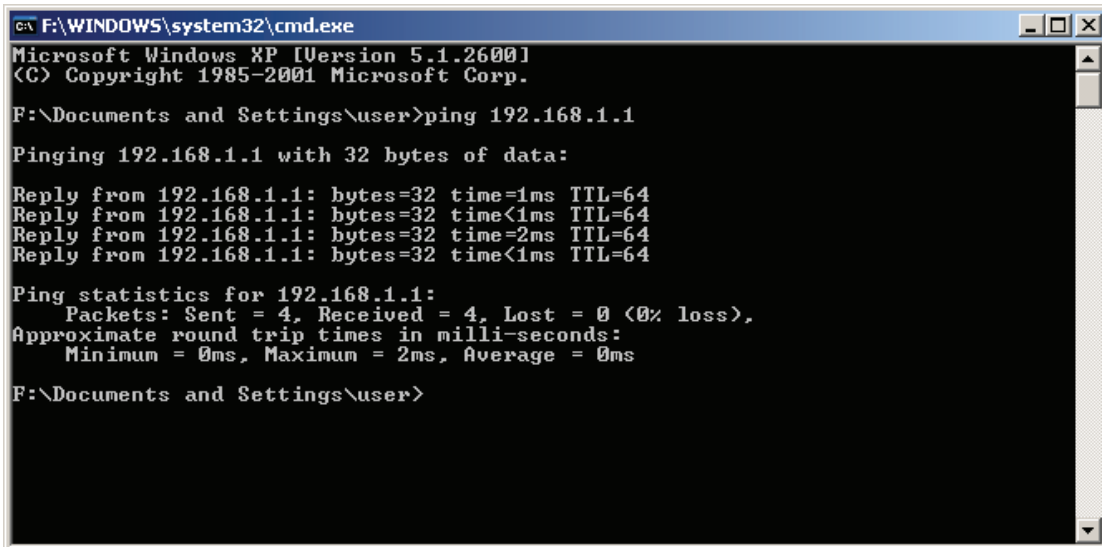

```

c:\ F:\WINDOWS\system32\cmd.exe
Microsoft Windows XP [Version 5.1.2600]
(C) Copyright 1985-2001 Microsoft Corp.

F:\Documents and Settings\user>ping 192.168.1.1

Pinging 192.168.1.1 with 32 bytes of data:

Reply from 192.168.1.1: bytes=32 time=1ms TTL=64
Reply from 192.168.1.1: bytes=32 time<1ms TTL=64
Reply from 192.168.1.1: bytes=32 time=2ms TTL=64
Reply from 192.168.1.1: bytes=32 time<1ms TTL=64

Ping statistics for 192.168.1.1:
    Packets: Sent = 4, Received = 4, Lost = 0 (0% loss),
    Approximate round trip times in milli-seconds:
        Minimum = 0ms, Maximum = 2ms, Average = 0ms

F:\Documents and Settings\user>

```

Figure 3-1

If the result displayed is similar to that shown in Figure 3-2, it means that your PC has not connected to the router.

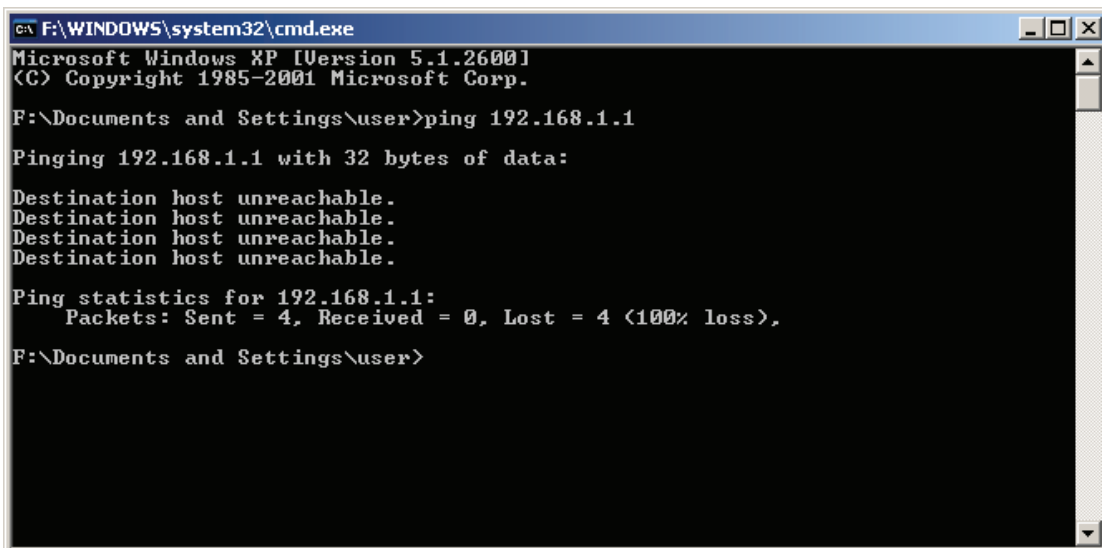

```

c:\ F:\WINDOWS\system32\cmd.exe
Microsoft Windows XP [Version 5.1.2600]
(C) Copyright 1985-2001 Microsoft Corp.

F:\Documents and Settings\user>ping 192.168.1.1

Pinging 192.168.1.1 with 32 bytes of data:

Destination host unreachable.
Destination host unreachable.
Destination host unreachable.
Destination host unreachable.

Ping statistics for 192.168.1.1:
    Packets: Sent = 4, Received = 0, Lost = 4 (100% loss),

F:\Documents and Settings\user>

```

Figure 3-2

Please check the connection following these steps:

1. Is the connection between your PC and the router correct?

 **Note:**

The 1/2/3/4 LEDs of LAN port which you link to on the router and LEDs on your PC's adapter should be lit.

2. Is the TCP/IP configuration for your PC correct?

 **Note:**

If the router's IP address is 192.168.1.1, your PC's IP address must be within the range of

192.168.1.2 ~ 192.168.1.254, the gateway must be 192.168.1.1

3.2 Quick Installation Guide

With a Web-based (Internet Explorer or Netscape® Navigator) utility, it is easy to configure and manage the TL-WR641G 108Mbps Wireless Router. The Web-based utility can be used on any Windows, Macintosh or UNIX OS with a Web browser.

Connect to the router by typing *http://192.168.1.1* in the address field of Web browser.



Figure 3-3

After a moment, a login window will appear similar to that shown in Figure 3-4. Enter **admin** for the User Name and Password, both in lower case letters. Then click the **OK** button or press the **Enter** key.



Figure 3-4

Note:

- 1) If the above screen does not pop-up, it means that your Web-browser has been set to a proxy. Go to Tools menu>Internet Options>Connections>LAN Settings, in the screen that appears, cancel the Using Proxy checkbox, and click OK to finish it.
- 2) If the User Name and Password are correct, you can configure the router using the Web browser. Please click the **Quick Setup** link on the left of the main menu and the Quick Setup screen will appear.

Quick Setup

The quick setup will tell you how to configure the basic network parameters.

To continue, please click the **Next** button.

To exit, please click the **Exit** button.



Figure 3-5

Click **Next**, and then **Choose WAN Connection Type** page will appear, shown in Figure 3-6.

Quick Setup - Choose WAN Connection Type

Please choose WAN Connection Type:

- PPPoE
- Dynamic IP
- Static IP



Figure 3-6

The router supports three popular ways to connect to Internet. Please select one compatible with your ISP. Click **Next** to enter the necessary network parameters.

If you choose "PPPoE", you will see this page shown in Figure 3-7:

Quick Setup - PPPoE

Account Name:

Password:



Figure 3-7

- **Account Name** and **Password** - Enter the **Account Name** and **Password** provided by your ISP. These fields are case sensitive. If you have difficulty with this process, please contact your ISP.

If you choose "**Dynamic IP**", the router will automatically receive the IP parameters from your ISP without needing to enter any parameters.

If you Choose "**Static IP**", the Static IP settings page will appear, shown in Figure 3-8:

Quick Setup - Static IP

IP Address:	<input type="text" value="0.0.0.0"/>	
Subnet Mask:	<input type="text" value="0.0.0.0"/>	
Default Gateway:	<input type="text" value="0.0.0.0"/>	(Optional)
Primary DNS:	<input type="text" value="0.0.0.0"/>	(Optional)
Secondary DNS:	<input type="text" value="0.0.0.0"/>	(Optional)

Figure 3-8

Note:

The IP parameters should have been provided by your ISP.

- **IP Address** - This is the WAN IP address as seen by external users on the Internet (including your ISP). Enter the IP address into the field.
- **Subnet Mask** - The Subnet Mask is used for the WAN IP address, it is usually 255.255.255.0
- **Default Gateway** - Enter the gateway IP address into the box if required.
- **Primary DNS** - Enter the DNS Server IP address into the boxes if required.
- **Secondary DNS** - If your ISP provides another DNS server, enter it into this field.

After you complete the above, click **Next**, the Wireless settings page will appear, shown in Figure 3-9.

Quick Setup - Wireless

Wireless Radio:	<input type="text" value="Enable"/>
SSID:	<input type="text" value="TP-LINK"/>
Region:	<input type="text" value="United States"/>
Channel:	<input type="text" value="6"/>
Mode:	<input type="text" value="108Mbps (Static)"/>

Figure 3-9

In this page, you can configure the following wireless parameters:

- **Wireless Radio** - Indicates whether the Access Point feature of the router is enabled or disabled. If disabled, the WLAN LED on the front panel will not be lit and the wireless stations will not be able to access the router. If enabled, the WLAN LED will be lit up and wireless stations will be able to access the router.
- **SSID** - Enter a value of up to 32 characters. The same SSID must be assigned to all wireless devices on your network. The default SSID is TP-LINK. This value is case-sensitive. For example, *TP-LINK* is NOT the same as *tp-link*.

- **Region** - Select your region from the pull-down list. This field specifies the region where the wireless function of the router can be used. It may be illegal to use the wireless function of the router in a region other than one of those specified in this field.
- **Channel** - The current channel in use. This field determines which operating frequency will be used.
- **Mode** - Indicates the current mode (**108Mbps (Dynamic)**, **108Mbps (Static)**, **54Mbps (802.11g)**, **11Mbps (802.11b)**). If you select **108Mbps (Dynamic)**, it is compatible with **54Mbps (802.11g)** and **11Mbps (802.11b)**. If you select **54Mbps (802.11g)**, it is compatible with **11Mbps (802.11b)**.

These settings are only for basic wireless parameters, for advanced settings, please refer to [Section 4.5: "Wireless."](#)

 **Note:**

The change of wireless settings won't take effect until the router reboots! You can reboot it manually. If you need instructions as to how to do this, please refer to [Section 4.12.5: "Reboot"](#)

Click the **Next** button. You will then see the Finish page:

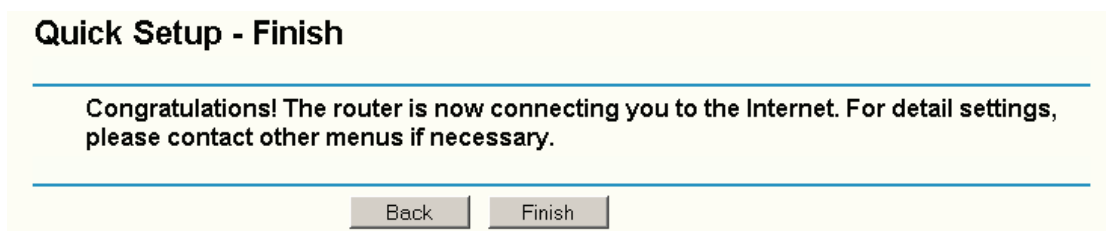

Figure 3-10

After finishing all configurations of basic network parameters, please click **Finish** button to exit this **Quick Setup**.

Chapter 4. Configuring the Router

This chapter describes each Web page's key functions.

4.1 Login

After your successful login, you can configure and manage the router. There are ten main menus on the left of the Web-based utility. Submenus will be available after you click one of the main menus. The eleven main menus are: **Status, Quick Setup, Network, Wireless, DHCP, Forwarding, Security, IP & MAC Binding Setting, Static Routing, DDNS and System Tools.** On the right of the Web-based utility, there are the detailed explanations and instructions for the corresponding page. To apply any settings you have altered on the page, please click the **Save** button.

The detailed explanations for each Web page key's function are listed below.

4.2 Status

The Status page displays the router's current status and configuration. All information is read-only.

1. LAN

This field displays the current settings or information for the LAN, including the **MAC address, IP address and Subnet Mask.**

2. Wireless

This field displays basic information or status for wireless function, including **Wireless Radio, SSID, Channel, Mode, Wireless MAC address, and IP address.**

3. WAN

These parameters apply to the WAN port of the router, including **MAC address, IP address, Subnet Mask, Default Gateway, DNS server and WAN connection type.** If PPPoE is chosen as the WAN connection type, the **Disconnect** button will be shown here while you are accessing the Internet. You can also cut the connection by clicking the button. If you have not connected to the Internet, just click **Connect** to establish the connection.

4. Traffic Statistics

This field displays the router's traffic statistics.

5. System Up Time

The total up time of the router from when it was switched on or reset.

Router Status

Firmware Version:	3.3.0 Build 061109 Rel.38437n	
Hardware Version:	WR641G/642G v3 08140201	

LAN

MAC Address:	00-0A-EB-BE-F1-2E	
IP Address:	192.168.1.1	
Subnet Mask:	255.255.255.0	

Wireless

Wireless Radio:	Disabled	
Name (SSID):	TP-LINKdwdf	
Channel:	6	
Mode:	108Mbps (Static)	
MAC Address:	00-0A-EB-BE-F1-2E	
IP Address:	192.168.1.1	

WAN

MAC Address:	00-0A-EB-BE-F1-2F	
IP Address:	222.66.66.26	Static IP
Subnet Mask:	255.255.255.0	
Default Gateway:	222.66.66.1	
DNS Server:	0.0.0.0 , 0.0.0.0	

Traffic Statistics

	Received	Sent
Bytes:	0	1708
Packets:	0	26

System Up Time: 0 day(s) 00:09:30

Figure 4-1

4.3 Quick Setup

Please refer to [Section 3.2: "Quick Installation Guide."](#)

4.4 Network



Figure 4-2

There are three submenus under the Network menu (shown in Figure 4-2): **LAN**, **WAN** and **MAC Clone**. Click any of them, and you will be able to configure the corresponding function. The detailed explanations for each submenu are provided below.

4.4.1 LAN

You can configure the IP parameters of LAN on this page.

 A screenshot of the "LAN" configuration page. The page has a light yellow background. At the top left, the word "LAN" is written in bold. Below it, there are three rows of configuration fields:

- MAC Address:** 00-0A-EB-00-23-11
- IP Address:** A text input field containing "192.168.1.1".
- Subnet Mask:** A dropdown menu showing "255.255.255.0".

 At the bottom center, there is a "Save" button.

Figure 4-3

- **MAC Address** - The physical address of the router, as seen from the LAN. The value can't be changed.
- **IP Address** - Enter the IP address of your router in dotted-decimal notation (factory default: 192.168.1.1).
- **Subnet Mask** - An address code that determines the size of the network. Normally use 255.255.255.0 as the subnet mask.

Note:

- 1) If you change the IP Address of LAN, you must use the new IP Address to login the router.
- 2) If the new LAN IP Address you set is not in the same subnet, the IP Address pool of the DHCP server will not take effect, until they are re-configured.
- 3) If the new LAN IP Address you set is not in the same subnet, the Virtual Server and DMZ Host will change accordingly at the same time.

4.4.2 WAN

You can configure the WAN port parameters on this page.

First, please choose the WAN Connection Type (Dynamic IP/Static IP/PPPoE/802.1X + Dynamic IP/802.1X + Static IP/Big Pond Cable/L2TP/PPTP) for Internet. The default type is

Dynamic IP. If you aren't given any login parameters (fixed IP Address, logging ID, etc), please select **Dynamic IP**. If you are given a fixed IP (static IP), please select **Static IP**. If you are given a user name and a password, please select the type of your ISP provided (PPPoE/BigPond/L2TP/PPTP). If you are not sure which connection type you use currently, please contact your ISP to obtain the correct information.

1. If you choose **Dynamic IP**, the router will automatically get IP parameters from your ISP. You can see the page as follows (Figure 4-4):

The screenshot shows the WAN configuration interface. At the top, the title 'WAN' is displayed. Below it, the 'WAN Connection Type' is set to 'Dynamic IP' in a dropdown menu. The 'Host Name' field is empty. The 'IP Address', 'Subnet Mask', and 'Default Gateway' fields all contain '0.0.0.0'. Below these fields are 'Renew' and 'Release' buttons, followed by the text 'Obtaining network parameters...'. The 'MTU Size (in bytes)' is set to '1500' with a note: '(The default is 1500, do not change unless necessary.)'. There are two checkboxes: 'Use These DNS Servers' (unchecked) and 'Get IP with Unicast DHCP (It is usually not required.)' (unchecked). The 'Primary DNS' and 'Secondary DNS' fields both contain '0.0.0.0', with '(Optional)' next to the secondary field. A 'Save' button is at the bottom.

Figure 4-4

This page displays the WAN IP parameters assigned dynamically by your ISP, including IP address, Subnet Mask, Default Gateway, etc. Click the **Renew** button to renew the IP parameters from your ISP. Click the **Release** button to release the IP parameters.

- **MTU Size** - The normal MTU (Maximum Transmission Unit) value for most Ethernet networks is 1500 Bytes. For some ISPs you need to reduce the MTU. But this is rarely required, and should not be done unless you are sure it is necessary for your ISP connection.
- **Use These DNS Servers** - If your ISP gives you one or two DNS addresses, select **Use These DNS Servers** and enter the primary and secondary addresses into the correct fields. Otherwise, the DNS servers will be assigned dynamically from your ISP.

Note:

If you get address and find error when you go to a Web site, it is likely that your DNS servers are set up improperly. You should contact your ISP to get DNS server addresses.

- **Get IP with Unicast DHCP** - A few ISPs' DHCP servers do not support the broadcast applications. If you cannot get the IP Address normally, you can choose this option. (This is rarely required.)
2. If you choose **Static IP**, you should have fixed IP Parameters specified by your ISP. The Static IP settings page will appear, shown in Figure 4-5:

WAN

WAN Connection Type:

IP Address:

Subnet Mask:

Default Gateway: (Optional)

MTU Size (in bytes): (The default is 1500, do not change unless necessary.)

Primary DNS: (Optional)

Secondary DNS: (Optional)

Figure 4-5

You should type the following parameters into the spaces provided:

- **IP Address** - Enter the IP address in dotted-decimal notation provided by your ISP.
 - **Subnet Mask** - Enter the subnet Mask in dotted-decimal notation provided by your ISP, usually is 255.255.255.0.
 - **Default Gateway** - (Optional) Enter the gateway IP address in dotted-decimal notation provided by your ISP.
 - **MTU Size** - The normal MTU (Maximum Transmission Unit) value for most Ethernet networks is 1500 Bytes. For some ISPs you may need to modify the MTU. But this is rarely required, and should not be done unless you are sure it is necessary for your ISP connection.
 - **Primary DNS** - (Optional) Enter the DNS address in dotted-decimal notation provided by your ISP.
 - **Secondary DNS** - (Optional) Type another DNS address in dotted-decimal notation provided by your ISP if provided.
3. If you choose **PPPoE**, you should enter the following parameters (Figure 4-6):

WAN

WAN Connection Type:

User Name:

Password:

Wan Connection Mode:

- Connect on Demand
 - Max Idle Time: minutes (0 means remain active at all times.)
- Connect Automatically
- Time-based Connecting
 - Period of Time: from : (HH:MM) to : (HH:MM)
- Connect Manually
 - Max Idle Time: minutes (0 means remain active at all times.)

Figure 4-6

- **User Name/Password** - Enter the User Name and Password provided by your ISP. These fields are case-sensitive.
- **Connect on Demand** - You can configure the router to disconnect your Internet connection after a specified period of inactivity (**Max Idle Time**). If your Internet connection has been terminated due to inactivity, **Connect on Demand** enables the router to automatically re-establish your connection as soon as you attempt to access the Internet again. If you wish to activate **Connect on Demand**, click the radio button. If you want your Internet connection to remain active at all times, enter 0 in the **Max Idle Time** field. Otherwise, enter the number of minutes you want to have elapsed before your Internet connection terminates.

Caution: Sometimes the connection cannot be disconnected although you specify a time to Max Idle Time, since some applications is visiting the Internet continually in the background.
- **Connect Automatically** - Connect automatically after the router is disconnected. To use this option, click the radio button.
- **Time-based Connecting** - You can configure the router to make it connect or disconnect based on time. Enter the start time in HH:MM format for connecting and end time in HH:MM format for disconnecting in the **Period of Time** fields.

Note:

Only when you have configured the system time on **System Tools -> Time** page, will the **Time-based Connecting** function can take effect.

- **Connect Manually** - You can configure the router to make it connect or disconnect

manually. After a specified period of inactivity (**Max Idle Time**), the router will disconnect from the Internet connection, and you will not be able to re-establish your connection automatically as soon as you attempt to access the Internet again. To use this option, click the radio button. If you want your Internet connection to remain active at all times, enter "0" in the **Max Idle Time** field. Otherwise, enter the number time in minutes that you wish to have the Internet connecting last unless a new link is requested.

Note:

Sometimes the connection cannot be disconnected although you specify a time to Max Idle Time, since some applications are visiting the Internet continually in the background.

Click the **Connect** button to connect immediately. Click the **Disconnect** button to disconnect immediately.

Click the **Advanced Settings** button to set up the advanced option, the page shown in Figure 4-7 will then appear:

Figure 4-7

- **Packet MTU** - The default MTU size is 1480 bytes, which value is usually fine. For some ISPs, you need modify the MTU. This should not be done unless you are sure it is necessary for your ISP.
- **Service Name/AC Name** - The service name and AC (Access Concentrator) name, these should not be configured unless you are sure it is necessary for your ISP.
- **ISP Specified IP Address** - If you know that your ISP does not automatically transmit your IP address to the router during login, click “**Use the IP Address specified by ISP**” check box and enter the IP Address in dotted-decimal notation, which your ISP provided.
- **Detect Online Interval** - The default value is 0, you can input the value between 0 and 120.

The router will detect Access Concentrator online at every interval between seconds. If the value is 0, it means, do not detect.

- **DNS IP address** - If you know that your ISP does not automatically transmit DNS addresses to the router during login, click **“Use the following DNS servers”** checkbox and enter the IP address in dotted-decimal notation of your ISP’s primary DNS server. If a secondary DNS server address is available, enter it as well.

Click the **Save** button to save your settings.

4. If you choose **802.1X + Dynamic IP**, you should enter the follow parameters(Figure 4-8):

WAN

WAN Connection Type: 802.1X + Dynamic IP

User Name:

Password:

Host Name:

IP Address: 0.0.0.0

Subnet Mask: 0.0.0.0

Default Gateway: 0.0.0.0

MTU Size (in bytes): (The default is 1500, do not change unless necessary.)

Use These DNS Servers

Primary DNS:

Secondary DNS: (Optional)

Get IP with Unicast DHCP (It is usually not required.)

Figure 4-8

- **User Name** - Enter the user name for 802.1X authentication provided by your ISP
- **Password** - Enter the password for 802.1X authentication provided by your ISP.

Click **Login** to start 802.1X authentication.

Click **Logout** to end 802.1X authentication.

- **Host Name** - This field is required to be filled by some service provider.

5. If you choose **802.1X + Static IP**, you should enter the follow parameters(Figure 4-9):

WAN

WAN Connection Type:

User Name:

Password:

IP Address:

Subnet Mask:

Default Gateway: (Optional)

MTU Size (in bytes): (The default is 1500, do not change unless necessary.)

Primary DNS: (Optional)

Secondary DNS: (Optional)

Figure 4-9

- **User Name** - Enter the user name for 802.1X authentication provided by your ISP
- **Password** - Enter the password for 802.1X authentication provided by your ISP.

Click **Login** to start 802.1X authentication.

Click **Logout** to end 802.1X authentication.

- **IP Address** - Enter the IP address in dotted-decimal notation provided by your ISP.
- **Subnet Mask** - Enter the subnet Mask in dotted-decimal notation provided by your ISP.
- **Default Gateway** - (Optional) Enter the default gateway IP address in dotted-decimal notation provided by your ISP.

6. If you choose **Big Pond Cable**, you should enter the following parameters (Figure 4-10):

WAN

WAN Connection Type:

User Name:

Password:

Auth Server:

Auth Domain:

MTU Size (in bytes): (The default is 1500, do not change unless necessary.)

Connect on Demand
 Max Idle Time: minutes (0 means remain active at all times.)

Connect Automatically

Connect Manually
 Max Idle Time: minutes (0 means remain active at all times.)

Disconnected

Figure 4-10

- **User Name/Password** - Enter the User Name and Password provided by your ISP. These fields are case-sensitive.
 - **Auth Server** - Enter the authenticating server IP address or host name.
 - **Auth Domain** - Type in the domain suffix server name based on your location. E.g.,
 NSW / ACT - **nsw.bigpond.net.au**
 VIC / TAS / WA / SA / NT - **vic.bigpond.net.au**
 QLD - **qld.bigpond.net.au**
 - **Connect on Demand** - You can configure the router to disconnect from your Internet connection after a specified period of inactivity (**Max Idle Time**). If your Internet connection has been terminated due to inactivity, **Connect on Demand** enables the router to automatically re-establish your connection as soon as you attempt to access the Internet again. If you wish to activate **Connect on Demand**, click the radio button. If you want your Internet connection to remain active at all times, enter 0 in the **Max Idle Time** field. Otherwise, enter the number of minutes you want to have elapsed before your Internet connection terminates.
- Caution:** Sometimes the connection cannot be disconnected although you specify a time to Max Idle Time, since some applications are visiting the Internet continually in the background.
- **Connect Automatically** - Connect automatically after the router is disconnected. To use this option, click the radio button.

- **Connect Manually** - You can configure the router to make it connect or disconnect manually. After a specified period of inactivity (**Max Idle Time**), the router will disconnect from your Internet connection, and you will not be able to re-establish your connection automatically as soon as you attempt to access the Internet again. To use this option, click the radio button. If you want your Internet connection to remain active at all times, enter "0" in the **Max Idle Time** field. Otherwise, enter the number in minutes that you wish to have the Internet connecting last unless a new link is requested.

Note:

Sometimes the connection cannot be disconnected although you specify a time to Max Idle Time, since some applications are visiting the Internet continually in the background.

Click the **Connect** button to connect immediately. Click the **Disconnect** button to disconnect immediately.

7. If you choose **L2TP**, you should enter the following parameters (Figure 4-11):

WAN

WAN Connection Type: L2TP

User Name: username

Password: ●●●●●●

Connect Disconnect **Disconnected!**

Dynamic IP Static IP

Server IP Address/Name: [Empty Field]

IP Address: 0.0.0.0

Subnet Mask: 0.0.0.0

Gateway: 0.0.0.0

DNS: 0.0.0.0

Internet IP Address: 0.0.0.0

Internet DNS: 0.0.0.0, 0.0.0.0

MTU Size (in bytes): 1460 (The default is 1460, do not change unless necessary.)

Max Idle Time: 15 minutes (0 means remain active at all times.)

Wan Connection Mode: Connect on Demand
 Connect Automatically
 Connect Manually

Save

Figure 4-11

- **User Name/Password** - Enter the User Name and Password provided by your ISP. These

fields are case-sensitive.

- **Dynamic IP/ Static IP** – Choose either as you are given by your ISP.

Click the **Connect** button to connect immediately. Click the **Disconnect** button to disconnect immediately.

- **Connect on Demand** - You can configure the router to disconnect from your Internet connection after a specified period of inactivity (**Max Idle Time**). If your Internet connection has been terminated due to inactivity, **Connect on Demand** enables the router to automatically re-establish your connection as soon as you attempt to access the Internet again. If you wish to activate **Connect on Demand**, click the radio button. If you want your Internet connection to remain active at all times, enter 0 in the **Max Idle Time** field. Otherwise, enter the number of minutes you want to have elapsed before your Internet connection terminates.

 **Note:**

Sometimes the connection cannot be disconnected although you specify a time to Max Idle Time, since some applications is visiting the Internet continually in the background.

- **Connect Automatically** - Connect automatically after the router is disconnected. To use this option, click the radio button.
- **Connect Manually** - You can configure the router to make it connect or disconnect manually. After a specified period of inactivity (**Max Idle Time**), the router will disconnect from your Internet connection, and you will not be able to re-establish your connection automatically as soon as you attempt to access the Internet again. To use this option, click the radio button. If you want your Internet connection to remain active at all times, enter "0" in the **Max Idle Time** field. Otherwise, enter the number in minutes that you wish to have the Internet connecting last unless a new link is requested.

 **Note:**

Sometimes the connection cannot be disconnected although you specify a time to Max Idle Time, since some applications is visiting the Internet continually in the background.

8. If you choose **PPTP**, you should enter the following parameters (Figure 4-12):

WAN

WAN Connection Type: PPTP

User Name:

Password:

Disconnected!

Dynamic IP Static IP

Server IP Address/Name:

IP Address:

Subnet Mask:

Gateway:

DNS:

Internet IP Address: 0.0.0.0

Internet DNS: 0.0.0.0, 0.0.0.0

MTU Size (in bytes): (The default is 1420, do not change unless necessary.)

Max Idle Time: minutes (0 means remain active at all times.)

Wan Connection Mode: Connect on Demand
 Connect Automatically
 Connect Manually

Figure 4-12

- **User Name/Password** - Enter the User Name and Password provided by your ISP. These fields are case-sensitive.
- **Dynamic IP/ Static IP** – Choose either as you are given by your ISP and enter the ISP's IP address or the domain name.

If you choose static IP and enter the domain name, you should also enter the DNS assigned by your ISP. And click the **Save** button.

Click the **Connect** button to connect immediately. Click the **Disconnect** button to disconnect immediately.

- **Connect on Demand** - You can configure the router to disconnect from your Internet connection after a specified period of inactivity (**Max Idle Time**). If your Internet connection has been terminated due to inactivity, **Connect on Demand** enables the router to automatically re-establish your connection as soon as you attempt to access the Internet again. If you wish to activate **Connect on Demand**, click the radio button. If you want your Internet connection to remain active at all times, enter 0 in the **Max Idle Time** field.

Otherwise, enter the number of minutes you want to have elapsed before your Internet connection terminates.

Caution: Sometimes the connection cannot be disconnected although you specify a time to Max Idle Time, since some applications are visiting the Internet continually in the background.

- **Connect Automatically** - Connect automatically after the router is disconnected. To use this option, click the radio button.
- **Connect Manually** - You can configure the router to make it connect or disconnect manually. After a specified period of inactivity (**Max Idle Time**), the router will disconnect from your Internet connection, and you will not be able to re-establish your connection automatically as soon as you attempt to access the Internet again. To use this option, click the radio button. If you want your Internet connection to remain active at all times, enter "0" in the **Max Idle Time** field. Otherwise, enter the number in minutes that you wish to have the Internet connecting last unless a new link is requested.

 **Note:**

Sometimes the connection cannot be disconnected although you specify a time to Max Idle Time, since some applications are visiting the Internet continually in the background.

4.4.3 MAC Clone

You can configure the MAC address of the WAN port on this page, Figure 4-13:

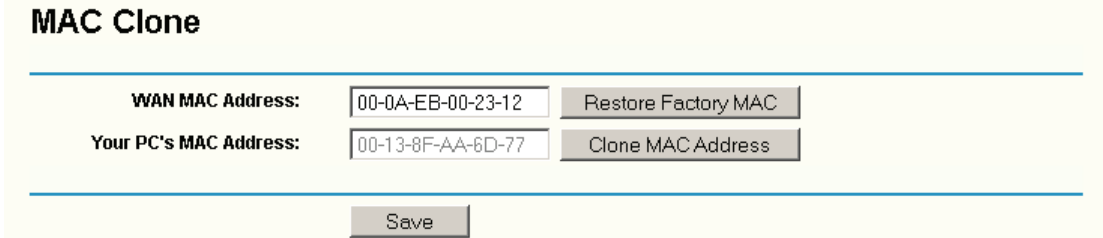

Figure 4-13

Some ISPs require that you register the MAC Address of your adapter, which is connected to your cable/DSL Modem or Ethernet during installation. Changes are rarely needed here.

WAN MAC Address - This field displays the current MAC address of the WAN port, which is used for the WAN port. If your ISP requires that you register the MAC address, please enter the correct MAC address into this field. The format for the MAC Address is XX-XX-XX-XX-XX-XX (X is any hexadecimal digit).

- **Your PC's MAC Address** - This field displays the MAC address of the PC that is managing the router. If the MAC address is required, you can click the **Clone MAC Address** button and this MAC address will fill in the **WAN MAC Address** field.

Click **Restore Factory MAC** to restore the MAC address of WAN port to the factory default value.

Click the **Save** button to save your settings.

 **Note:**

- 1) Only the PC on your LAN can use the **MAC Address Clone** feature.
- 2) If you click the **Save** button, the router will prompt you to reboot.

4.5 Wireless

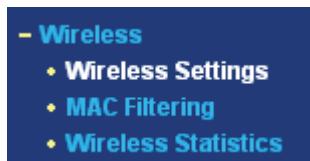

Figure 4-14

There are three submenus under the Wireless menu (shown in Figure 4-14): **Wireless Settings**, **MAC Filtering** and **Wireless Statistics**. Click any of them, and you will be able to configure the corresponding function. The detailed explanations for each submenu are provided below.

4.5.1 Wireless Settings

The basic settings for the wireless network are set on this page, Figure 4-15:

Wireless Settings

SSID:

Region:

Warning: Ensure you select a correct country to conform local law. Incorrect settings may cause interference.

Channel:

Mode:

Enable Wireless Router Radio

Enable SSID Broadcast

Enable Bridges

MAC of AP1:

MAC of AP2:

MAC of AP3:

MAC of AP4:

MAC of AP5:

MAC of AP6:

Enable Wireless Security

Security Type:

Security Option:

WEP Key Format:

Key Selected	WEP Key	Key Type
Key 1: <input type="radio"/>	<input type="text"/>	<input type="text" value="Disabled"/>
Key 2: <input type="radio"/>	<input type="text"/>	<input type="text" value="Disabled"/>
Key 3: <input type="radio"/>	<input type="text"/>	<input type="text" value="Disabled"/>
Key 4: <input type="radio"/>	<input type="text"/>	<input type="text" value="Disabled"/>

Figure 4-15

- **SSID** - Enter a value of up to 32 characters. The same name (SSID) must be assigned to all wireless devices in your network. The default SSID is TP-LINK, but it is recommended strongly that you change your networks name (SSID) to a different value. This value is case-sensitive. For example, *TP-LINK* is NOT the same as *tp-link*.

- **Region** - Select your region from the pull-down list. This field specifies the region where the wireless function of the router can be used. It may be illegal to use the wireless function of the router in a region other than one of those specified in this field. If your country or region is not listed, please contact your local government agency for assistance.

The default region is United States. When you select your local region from the pull-down list, Click the **Save** button, then the Note Dialog appears. Click OK.

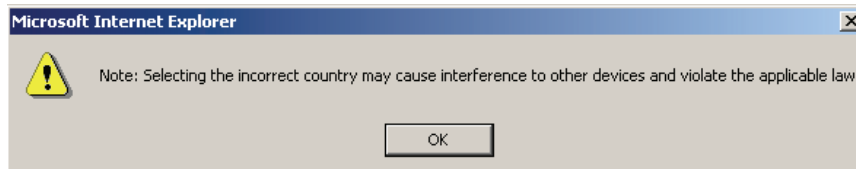

Figure 4-16

Note:

Some regions may not use **108Mbps Mode** since the operation for the wireless interface in 108Mbps Mode is illegal. Limited by local law regulations, version for North America does not have region selection option.

- **Channel** - This field determines which operating frequency will be used. It is not necessary to change the wireless channel unless you notice interference problems with another nearby access point.
- **Mode** - Select the desired wireless mode. The options are:
 - **108Mbps (Dynamic)** - Super G™, 802.11g and 802.11b wireless stations can connect to the router.
 - **108Mbps (Static)** - Only Super G™ wireless stations can connect to the router.
 - **54Mbps (802.11g)** - Both 802.11g and 802.11b wireless stations can connect to the router.
 - **11Mbps (802.11b)** - Only 802.11b wireless stations can connect to the router.

Note:

The default is "54Mbps (802.11g)", which allows both 802.11g and 802.11b wireless stations to connect to the router.

- **Enable Wireless Router Radio** - The wireless radio of this Router can be enabled or disabled to allow wireless stations access. If enabled, wireless stations will be able to access the router. Otherwise, wireless stations will not be able to access.
- **Enable SSID Broadcast** - If you select the **Enable SSID Broadcast** checkbox, the Wireless Router SSID will broadcast its name (SSID) on the air.
- **Enable Bridges** - If you select the **Enable Bridges** checkbox, you can input MAC address of other APs to communicate with them wirelessly in Bridge mode.

- MAC of AP (1-6): Input the MAC address of the AP which you want to communicate with. There are six entries can be configured.

The APs can communicate with each other in Bridge mode unless they know each other's MAC address. For example, if the router whose MAC address is 00-13-56-A8-9E-1A wants to communicate with an AP whose MAC address is 00-13-56-A8-9E-1B in Bridge mode, you should do as following:

1. Select **Enable Bridges** and input 00-13-56-A8-9E-1B as following screen shown.

Enable Bridges
 MAC of AP1:
 MAC of AP2:
 MAC of AP3:
 MAC of AP4:
 MAC of AP5:
 MAC of AP6:

2. Access the AP's Web-based utility and configure the AP under Bridge mode, then input 00-13-56-A8-9E-1A in corresponding Blank.

- **Enable Wireless Security** – The wireless security function can be enabled or disabled. If disabled, the wireless stations will be able to connect the router without encryption. It is recommended strongly that you choose this option to encrypt your wireless network. The encryption settings are described below.
- **Authentication Type** - You can select one of the following authentication types:
 - **WEP** - Select WEP authentication type based on 802.11 authentications.
 - **WPA-PSK/WPA2-PSK** - Select WPA/WPA2 authentication type based on pre-shared passphrase.
 - **WPA /WPA2** - Select WPA/WPA2 authentication type based on Radius Server.
- **Authentication Options** - You can select one of the following authentication options:
 - When you select **WEP** for authentication type you can select the following authentication options:
 - **Automatic** - Select Shared Key or Open System authentication type automatically based on the wireless station request.
 - **Shared Key** - Select 802.11 Shared Key authentication.
 - **Open System** - Select 802.11 Open System authentication.
 - When you select **WPA-PSK/WPA2-PSK** for authentication type you can select **Automatic**, **WPA –PSK** or **WPA2-PSK** as authentication options.
 - When you select **WPA/WPA2** as an authentication type you can select **Automatic WPA** or **WPA2** as authentication option.

- **WEP Key Format** - You can select **ASCII** or **Hexadecimal** format. ASCII Code Format stands for any combination of keyboard characters in the specified length. Hexadecimal format stands for any combination of hexadecimal digits (0-9, a-f, A-F) in the specified length.
- **WEP Key settings** - Select which of the four keys will be used and enter the matching WEP key information for your network in the selected key radio button. These values must be identical on all wireless stations in your network.
- **Key Type** - You can select the WEP key length (**64-bit**, or **128-bit**, or **152-bit**) for encryption. "Disabled" means the WEP key entry is invalid.
 - For **64-bit** encryption - You can enter 10 hexadecimal digits (any combination of 0-9, a-f, A-F, zero key is not permitted) or 5 ASCII characters.
 - For **128-bit** encryption - You can enter 26 hexadecimal digits (any combination of 0-9, a-f, A-F, zero key is not permitted) or 13 ASCII characters.
 - For **152-bit** encryption - You can enter 32 hexadecimal digits (any combination of 0-9, a-f, A-F, zero key is not permitted) or 16 ASCII characters.
- **Encryption** - When you select **WPA-PSK/WPA2-PSK** or **WPA/WPA2** for **Authentication Type** you can select **Automatic**, **TKIP** or **AES** as **Encryptions**.

The screenshot shows a configuration panel with the following fields:

- Security Type:** WPA-PSK/WPA2-PSK (dropdown menu)
- Security Option:** Automatic (dropdown menu)
- Encryption:** Automatic (dropdown menu)
- PSK Passphrase:** [Empty text box]
- (The Passphrase is between 8 and 63 characters long)
- Group Key Update Period:** 30 (text box)
- (in second, minimum is 30, 0 means no update)

Figure 4-17

- **WPA-PSK/WPA2-PSK Passphrase** - You can enter a WPA or WPA2 passphrase between 8 and 63 characters long.
- **Group Key Update Period** - Specify the group key update interval in seconds. The value can be either 0 seconds or from 30 seconds and up, 1-29 seconds are not usable figures. Enter 0 to disable the update.

Security Type: WPA/WPA2

Security Option: Automatic

Encryption: Automatic

Radius Server IP: [Empty]

Radius Port: 1812 (1-65535, 0 means the default port 1812)

Radius password: [Empty]

Group Key Update Period: 30 (in second, minimum is 30, 0 means no update)

Figure 4-18

- **Radius Server IP** - Enter the IP address of the Radius Server
- **Radius Port** - Enter the port number that the radius service used.
- **Radius Password** - Enter the password for the Radius Server.

Be sure to click the **Save** button to save your settings on this page.

Note:

The router will reboot automatically after you click **save**.

4.5.2 MAC Filtering

The Wireless MAC Filtering for wireless networks is set on this page, Figure 4-19:

Wireless MAC Address Filtering

Wireless MAC Address Filtering: **Disabled** [Enable]

Filtering Rules

Allow the stations not specified by any enabled entries in the list to access

Deny the stations not specified by any enabled entries in the list to access

ID	MAC Address	Status	Privilege	<input checked="" type="radio"/> Description	<input type="radio"/> WEP Key	Modify
[Add New..]	[Enable All]	[Disable All]	[Delete All]			

[Previous] [Next]

Figure 4-19

The Wireless MAC Address Filtering feature allows you to control wireless stations accessing the router, which depend on the station's MAC addresses.

- **MAC Address** - The wireless station's MAC address that you want to access.
- **Status** - The status of this entry either **Enabled** or **Disabled**.
- **Privilege** - Select the privileges for this entry. You may select one of the following **Allow / Deny / 64-bit / 128-bit / 152-bit**.
- **Description** - A simple description of the wireless station.

- **WEP Key** - Specify a unique WEP key (in Hexadecimal format) to access the router.

To set up an entry, follow these instructions:

First, you must decide whether the unspecified wireless stations can access the router or not. If you desire that the unspecified wireless stations can access the router, please select the radio button **Allow the stations not specified by any enabled entries in the list to access**, otherwise, select the radio button **Deny the stations not specified by any enabled entries in the list to access**.

To Add a Wireless MAC Address filtering entry, click the **Add New...** button. The "**Add or Modify Wireless MAC Address Filtering entry**" page will appear, shown in Figure 4-20:

The screenshot shows a web page titled "Add or Modify Wireless MAC Address Filtering entry". The page contains a form with the following fields and controls:

- MAC Address:** A text input field.
- Description:** A text input field.
- Privilege:** A dropdown menu with "allow" selected.
- WEP Key:** A text input field.
- Status:** A dropdown menu with "Enabled" selected.

At the bottom of the form are two buttons: "Save" and "Return".

Figure 4-20

To add or modify a MAC Address Filtering entry, follow these instructions:

1. Enter the appropriate MAC Address into the **MAC Address** field. The format of the MAC Address is XX-XX-XX-XX-XX-XX (X is any hexadecimal digit). For example: 00-0A-EB-B0-00-0B.
2. Enter a simple description of the wireless station in the **Description** field. For example: Wireless station A.
3. **Privilege** - Select the privileges for this entry, one of **Allow / Deny / 64-bit / 128-bit / 152-bit**.
4. **WEP Key** - If you select **64-bit**, **128-bit** or **152-bit** in the **Privilege** field, enter any combination of hexadecimal digits (0-9, a-f, A-F) in the specified length. For example: 2F34D20BE2.
5. **Status** - Select **Enabled** or **Disabled** for this entry on the **Status** pull-down list.
6. Click the **Save** button to save this entry.

To add additional entries, repeat steps 1-6.

Note:

When 64-bit, or 128-bit, or 152-bit is selected, WEP Key will be enabled.

To modify or delete an existing entry:

1. Click the **Modify** in the entry you want to modify. If you want to delete the entry, click the **Delete**.
2. Modify the information.
3. Click the **Save** button.

Click the **Enable All** button to make all entries enabled

Click the **Disabled All** button to make all entries disabled.

Click the **Delete All** button to delete all entries

Click the **Next** button to go to the next page and click the **Previous** button to return to the previous page.

For example: If you desire that the wireless station A with MAC address 00-0A-EB-00-07-BE be able to access the router. The wireless station B with MAC address 00-0A-EB-00-07-5F not be able to access the router, and the wireless station C with MAC address 00-0A-EB-00-07-8A be able to access the router when its WEP key is 2F34D20BE2E54B326C5476586A, while all other wireless stations cannot access the router, you should configure the **Wireless MAC Address Filtering** list by following these steps:

1. Click the **Enable** button to enable this function.
2. Select the radio button: **Deny the stations not specified by any enabled entries in the list to access for Filtering Rules.**
3. Delete all or disable all entries if there are any entries already.
4. Click the **Add New...** button and enter the MAC address 00-0A-EB-00-07-BE in the **MAC Address** field, enter wireless station A in the **Description** field, select **Allow** in the **Privilege** pull-down list and select **Enabled** in the **Status** pull-down list. Click the **Save** and the **Return** button.
5. Click the **Add New...** button and enter the MAC address 00-0A-EB-00-07-5F in the **MAC Address** field, enter wireless station B in the **Description** field, select **Deny** in the **Privilege** pull-down list and select **Enabled** in the **Status** pull-down list. Click the **Save** and the **Return** button.
6. Click the **Add New...** button and enter the MAC address 00-0A-EB-00-07-8A in the **MAC Address** field, enter wireless station C in the **Description** field, select **128-bit** in the **Privilege** pull-down list, enter 2F34D20BE2E54B326C5476586A in the **WEP Key** field and select **Enabled** in the **Status** pull-down list. Click the **Save** and the **Return** button.

The filtering rules that configured should be similar to the following list:

ID	MAC Address	Status	Privilege	<input checked="" type="radio"/> Description <input type="radio"/> WEP Key	Modify
1	00-0A-EB-00-07-BE	Enabled	allow	Wireless Station A	Modify Delete
2	00-0A-EB-00-07-5F	Enabled	deny	Wireless Station B	Modify Delete
3	00-0A-EB-00-07-8A	Enabled	128 bit	Wireless Station C	Modify Delete

Figure 4-21

Note:

- 1) If you select the radio button **Allow the stations not specified by any enabled entries in the list to access** for **Filtering Rules**, the wireless station B will still not be able to access the router, however, other wireless stations that are not in the list will be able to access the router.
- 2) If you enable the function and select the **Deny the stations not specified by any enabled entries in the list to access** for **Filtering Rules**, and there are not any enable entries in the list, thus, no wireless stations can access the router.

4.5.3 Wireless Statistics

This page shows **MAC Address**, **Current Status**, **Received Packets** and **Sent Packets** for each connected wireless station.

Wireless Statistics				
Current Connected Wireless Stations numbers:		1	<input type="button" value="Refresh"/>	
ID	MAC Address	Current Status	Received Packets	Sent Packets
1	00-0A-EB-00-23-11	AP-UP	0	941
		<input type="button" value="Previous"/>	<input type="button" value="Next"/>	

Figure 4-22

- **MAC Address** - The connected wireless station's MAC address
- **Current Status** - The connected wireless station's running status, one of STA-AUTH / STA-ASSOC / AP-UP / WPA / WPA-PSK /WPA2/WPA2-PSK/None
- **Received Packets** - Packets received by the station
- **Sent Packets** - Packets sent by the station

You cannot change any of the values on this page. To update this page and to show the current connected wireless stations, click on the **Refresh** button.

If the numbers of connected wireless stations go beyond one page, click the **Next** button to go to the next page and click the **Previous** button to return the previous page.

Note:

This page will be refreshed automatically every 5 seconds.

4.6 DHCP

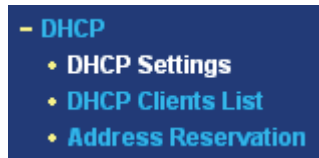

Figure 4-23

There are three submenus under the DHCP menu (shown in Figure 4-23): **DHCP Settings**, **DHCP Clients List** and **Address Reservation**. Click any of them, and you will be able to configure the corresponding function. The detailed explanations for each submenu are provided below.

4.6.1 DHCP Settings

The router is set up by default as a DHCP (Dynamic Host Configuration Protocol) server, which provides the TCP/IP configuration for all the PC(s) that are connected to the router on the LAN. The DHCP Server can be configured on the page (shown in Figure 4-24):

 A screenshot of the 'DHCP Settings' configuration page. The title 'DHCP Settings' is at the top left. Below it are several configuration fields:

- DHCP Server:** Radio buttons for 'Disable' and 'Enable' (selected).
- Start IP Address:** Text input field containing '192.168.1.100'.
- End IP Address:** Text input field containing '192.168.1.199'.
- Address Lease Time:** Text input field containing '120', followed by the text 'minutes (1~2880 minutes, the default value is 120)'.
- Default Gateway:** Text input field containing '0.0.0.0' with '(optional)' to its right.
- Default Domain:** Text input field with '(optional)' to its right.
- Primary DNS:** Text input field containing '0.0.0.0' with '(optional)' to its right.
- Secondary DNS:** Text input field containing '0.0.0.0' with '(optional)' to its right.

 At the bottom center of the form is a 'Save' button.

Figure 4-24

- **DHCP Server - Enable or Disable** the DHCP server. If you disable the Server, you must have another DHCP server within your network or else you must manually configure the computer.
- **Start IP Address** - This field specifies the first of the addresses in the IP address pool. 192.168.1.100 is the default start address.
- **End IP Address** - This field specifies the last of the addresses in the IP address pool. 192.168.1.199 is the default end address.
- **Address Lease Time** - The **Address Lease Time** is the amount of time in which a network user will be allowed connection to the router with their current dynamic IP Address. Enter the amount of time, in minutes. The user will be "leased" this dynamic IP Address. The range of the time is 1 ~ 2880 minutes. The default value is 120 minutes.

- **Default Gateway** - (Optional.) Suggest to input the IP address of the LAN port of the router, default value is 192.168.1.1
- **Default Domain** - (Optional.) Input the domain name of your network.
- **Primary DNS** - (Optional.) Input the DNS IP address provided by your ISP. Or consult your ISP.
- **Secondary DNS** - (Optional.) Input the IP address of another DNS server if your ISP provides two DNS servers.

 **Note:**

To use the DHCP server function of the router, you must configure all computers on the LAN as "Obtain an IP Address automatically" mode. This function will take effect until the router reboots.

4.6.2 DHCP Clients List

This page shows **Client Name**, **MAC Address**, **Assigned IP**, and **Lease Time** for each DHCP Client attached to the router (Figure 4-25):

DHCP Clients List				
ID	Client Name	MAC Address	Assigned IP	Lease Time
1	Anthea	00-13-8F-AA-6D-77	192.168.1.100	01:59:29

Figure 4-25

- **Index** - The index of the DHCP Client
- **Client Name** - The name of the DHCP client
- **MAC Address** - The MAC address of the DHCP client
- **Assigned IP** - The IP address that the router has allocated to the DHCP client.
- **Lease Time** - The time of the DHCP client leased. Before the time is up, DHCP client will request to renew the lease automatically.

You cannot change any of the values on this page. To update this page and to show the current attached devices, click on the **Refresh** button.

4.6.3 Address Reservation

When you specify a reserved IP address for a PC on the LAN, that PC will always receive the same IP address each time when it accesses the DHCP server. Reserved IP addresses should be assigned to servers that require permanent IP settings. This page is used for address reservation (shown in Figure 4-26).

Address Reservation

ID	MAC Address	Reserved IP Address	Status	Modify
1	00-0A-EB-00-23-11	192.168.1.100	Enabled	Modify Delete

Figure 4-26

- **MAC Address** - The MAC address of the PC of which you want to reserve IP address.
- **Assigned IP Address** - The IP address of the router reserved.
- **Status** - The status of this entry either **Enabled** or **Disabled**.

To Reserve IP addresses:

1. Click the **Add New** button. (Pop-up Figure 4-26)
2. Enter the MAC address (The format for the MAC Address is XX-XX-XX-XX-XX-XX.) and IP address in dotted-decimal notation of the computer you wish to add.
3. Click the **Save** button when finished.

Add or Modify a Address Reservation Entry

MAC Address:

Reserved IP Address:

Status:

Figure

e 4-27

To modify or delete an existing entry:

1. Click the **Modify** in the entry you want to modify. If you want to delete the entry, click the **Delete**.
2. Modify the information.
3. Click the **Save** button.

Click the **Enable All** button to make all entries enabled

Click the **Disabled All** button to make all entries disabled.

Click the **Delete All** button to delete all entries

Click the **Next** button to go to the next page and Click the **Previous** button to return the previous page.

 **Note:**

The function won't take effect until the router reboots.

4.7 Forwarding

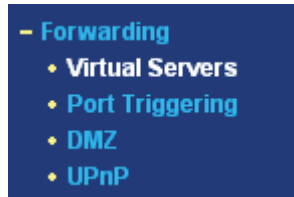

Figure 4-28

There are four submenus under the Forwarding menu (shown in Figure 4-28): **Virtual Servers**, **Port Triggering**, **DMZ** and **UPnP**. Click any of them, and you will be able to configure the corresponding function. The detailed explanations for each submenu are provided below.

4.7.1 Virtual Servers

Virtual servers can be used for setting up public services on your LAN, such as DNS, Email and FTP. A virtual server is defined as a service port, and all requests from the Internet to this service port will be redirected to the computer specified by the server IP. Any PC that was used for a virtual server must have a static or reserved IP Address because its IP Address may change when using the DHCP function. You can set up virtual servers on this page, shown in Figure 4-29:

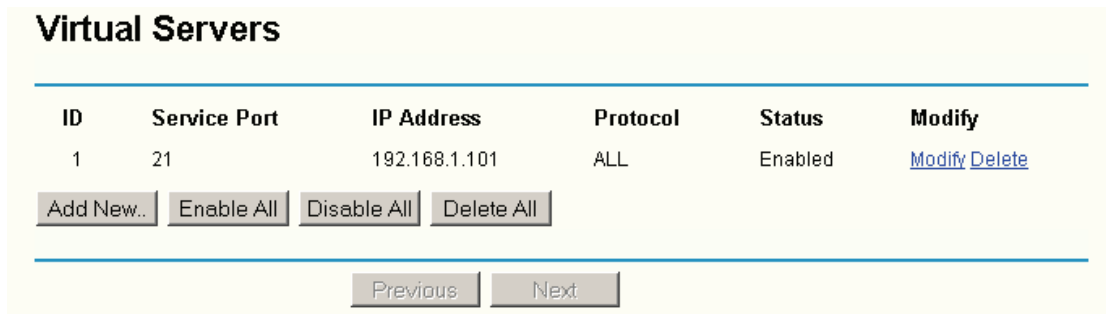

Figure 4-29

- **Service Port** - The numbers of External Ports. You can type a service port or a range of service ports (the format is XXX – YYY, XXX is the start port, YYY is the end port).
- **IP Address** - The IP Address of the PC providing the service application.
- **Protocol** - The protocol used for this application, either **TCP**, **UDP**, or **All** (all protocols supported by the router).
- **Status** - The status of this entry either **Enabled** or **Disabled**.

To setup a virtual server entry:

1. Click the **Add New** button.(pop-up Figure 4-29)
2. Select the service you want to use from the Common Service Port list. If the **Common**

Service Port list does not have the service that you want to use, type the number of the service port or service port range in the **Service Port** box.

3. Type the IP Address of the computer in the **Server IP Address** box.
4. Select the protocol used for this application, either **TCP** or **UDP**, or **All**.
5. Select the **Enable** checkbox to enable the virtual server.
6. Click the **Save** button.

Add or Modify a Virtual Server Entry

The screenshot shows a web form titled "Add or Modify a Virtual Server Entry". The form contains the following fields and controls:

- Service Port:** A text input field with a hint "(XX-XX or XX)".
- IP Address:** A text input field.
- Protocol:** A dropdown menu currently showing "ALL".
- Status:** A dropdown menu currently showing "Enabled".
- Common Service Port:** A dropdown menu currently showing "-Select One-".

At the bottom of the form are two buttons: "Save" and "Return".

Figur

e 4-30

Note:

It is possible that you have a computer or server that has more than one type of available service. If so, select another service, and enter the same IP Address for that computer or server.

To modify or delete an existing entry:

1. Click the **Modify** in the entry you want to modify. If you want to delete the entry, click the **Delete**.
2. Modify the information.
3. Click the **Save** button.

Click the **Enable All** button to make all entries enabled

Click the **Disabled All** button to make all entries disabled.

Click the **Delete All** button to delete all entries

Click the **Next** button to go to the next page and Click the **Previous** button to return the previous page.

Note:

If you set the virtual server of service port as 80, you must set the Web management port on **Security → Remote Management** page to be any value except 80 such as 8080. Or else there will be a conflict to disable the virtual server.

4.7.2 Port Triggering

Some applications require multiple connections, like Internet games, video conferencing, Internet calling and so on. These applications cannot work with a pure NAT router. Port Triggering is used for some of these applications that can work with an NAT router. You can set up Port Triggering on this page shown in Figure 4-31:

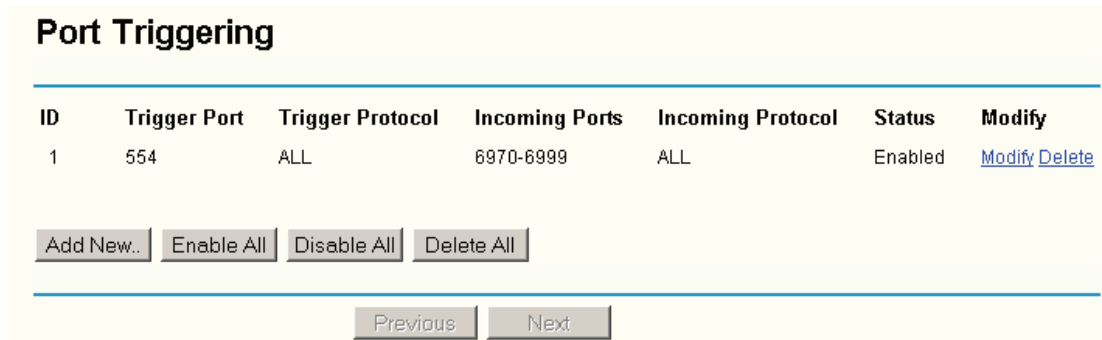

Figure 4-31

Once configured, operation is as follows:

1. A local host makes an outgoing connection using a destination port number defined in the Trigger Port field.
 2. The router records this connection, opens the incoming port or ports associated with this entry in the Port Triggering table, and associates them with the local host.
 3. When necessary the external host will be able to connect to the local host using one of the ports defined in the **Incoming Ports** field.
- **Trigger Port** - The port for outgoing traffic. An outgoing connection using this port will "Trigger" this rule.
 - **Trigger Protocol** - The protocol used for Trigger Ports, either **TCP**, **UDP**, or **All** (all protocols supported by the router).
 - **Incoming Ports Range** - The port or port range used by the remote system when it responds to the outgoing request. A response using one of these ports will be forwarded to the PC that triggered this rule. You can input at most 5 groups of ports (or port section). Every group of ports must be set apart with ",". For example, 2000-2038, 2050-2051, 2085, 3010-3030.
 - **Incoming Protocol** - The protocol used for Incoming Ports Range, either TCP or UDP, or ALL (all protocols supported by the router).
 - **Status** - The status of this entry either **Enabled** or **Disabled**.

To add a new rule, enter the following data on the **Port Triggering** screen.

1. Click the **Add New button**.(pop-up Figure 4-31)
2. Enter a port number used by the application when it generates an outgoing request.

3. Select the protocol used for **Trigger Port** from the pull-down list, either **TCP**, **UDP**, or **All**.
4. Enter the range of port numbers used by the remote system when it responds to the PC's request.
5. Select the protocol used for **Incoming Ports Range** from the pull-down list, either **TCP** or **UDP**, or **All**.
6. Select the **Enable** checkbox to enable.
7. Click the **Save** button to save the new rule.

Add or Modify a Port Triggering Entry

Trigger Port:

Trigger Protocol: ALL ▾

Incoming Ports:

Incoming Protocol: ALL ▾

Status: Enabled ▾

Common Applications: -Select One- ▾

Save Return

Figure

e 4-32

There are many popular applications in the **Popular Application** list. You can select it, and the application will fill in the **Trigger Port**, **incoming Ports Range** boxes and select the **Enable** checkbox. It has the same effect as adding a new rule.

To modify or delete an existing entry:

1. Click the **Modify** in the entry you want to modify. If you want to delete the entry, click the **Delete**.
2. Modify the information.
3. Click the **Save** button.

Click the **Enable All** button to make all entries enabled

Click the **Disabled All** button to make all entries disabled.

Click the **Delete All** button to delete all entries

Note:

- 1) When the trigger connection is released, the according opening ports will be closed.
- 2) Each rule allowed to be used only by one host on LAN synchronously. The trigger connection of other hosts on LAN will be refused.
- 3) Incoming Port Range cannot overlap each other.

4.7.3 DMZ

The DMZ host feature allows one local host to be exposed to the Internet for a special-purpose service such as Internet gaming or videoconferencing. DMZ host forwards all the ports at the same time. Any PC whose port is being forwarded must have its DHCP client function disabled and should have a new static IP Address assigned to it because its IP Address may change when using the DHCP function. You can set up DMZ host on this page shown in Figure 4-33:

Figure 4-33

To assign a computer or server to be a DMZ server:

1. Click the **Enable** radio button
2. Enter the local host IP Address in the **DMZ Host IP Address** field
3. Click the **Save** button.

Note:

After you set the DMZ host, the firewall related to the host will not work.

4.7.4 UPnP

The Universal Plug and Play (UPnP) feature allows the devices, such as Internet computers, to access the local host resources or devices as needed. UPnP devices can be automatically discovered by the UPnP service application on the LAN. You can configure UPnP on this page that shown in Figure 4-34:

Figure 4-34

- **Current UPnP Status** - UPnP can be enabled or disabled by clicking the **Enable** or **Disable** button. As allowing this may present a risk to security, this feature is disabled by default.
- **Current UPnP Settings List** - This table displays the current UPnP information.

- **App Description** – The description provided by the application in the UPnP request
- **External Port** - External port, which the router opened for the application.
- **Protocol** – Shows which type of protocol is opened.
- **Internal Port** - Internal port, which the router opened for local host.
- **IP Address** - The UPnP device that is currently accessing the router.
- **Status** - Either Enabled or Disabled, “Enabled” means that port is still active. Otherwise, the port is inactive.

Click **Refresh** to update the Current UPnP Settings List.

4.8 Security



Figure 4-35

There are six submenus under the Security menu (shown in Figure 4-35): **Firewall**, **IP Address Filtering**, **Domain Filtering**, **MAC Filtering**, **Remote Management** and **Advanced Security**. Click any of them, and you will be able to configure the corresponding function. The detailed explanations for each submenu are provided below.

4.8.1 Firewall

Using the Firewall page (shown in Figure 4-36), you can turn the general firewall switch on or off. The default setting for the switch is off. If the general firewall switch is off, even if IP Address Filtering, DNS Filtering and MAC Filtering are enabled, their settings are ineffective.

Firewall

- Enable Firewall (the general firewall switch)
- Enable IP Address Filtering
 Default IP Address Filtering Rules:
- Allow the packets not specified by any filtering rules to pass through the router
- Deny the packets not specified by any filtering rules to pass through the router
- Enable Domain Filtering
- Enable MAC Address Filtering
 Default MAC Address Filtering Rules:
- Allow these PCs with enabled rules to access the Internet
- Deny these PCs with enabled rules to access the Internet

Save

Figure 4-36

- **Enable IP Address Filtering** - set IP Address Filtering is enabled or disabled. There are two default filtering rules of IP Address Filtering, either Allow or Deny passing through the router.
- **Enable Domain Filtering** - set Domain Filtering is enabled or disabled.
- **Enable MAC Filtering** - set MAC Address Filtering is enabled or disabled. You can select the default filtering rules of MAC Address Filtering, either Allow or Deny accessing the router.

4.8.2 IP Address Filtering

The IP address Filtering feature allows you to control Internet Access by specific users on your LAN based on their IP addresses. The IP address filtering is set on this page, Figure 4-37:

IP Address Filtering

Firewall Settings (You can change it on Firewall page)

Enable Firewall: **Enabled**

Enable IP Address Filtering: **Enabled**

Default Filtering Rules: **Allow the packets not specified by any filtering rules to pass through the router**

ID	Effective time	LAN IP	LAN Port	WAN IP	WAN Port	Protocol	Action	Status	Modify
<div style="display: flex; justify-content: space-between; align-items: center;"> Add New.. Enable All Disable All Delete All </div> <div style="display: flex; align-items: center; margin-top: 5px;"> Move <input type="text"/> ID to ID <input type="text"/> </div>									

Figure 4-37

To disable the IP Address Filtering feature, keep the default setting, **Disabled**. To set up an IP Address Filtering entry, click **Enable** Firewall and **Enable** IP Address Filtering on the Firewall page, and click the **Add New...** button. The page "Add or Modify an IP Address Filtering entry" will appear shown in Figure 4-38:

Add or Modify an IP Address Filtering Entry

Effective time: -

LAN IP Address: -

LAN Port: -

WAN IP Address: -

WAN Port: -

Protocol:

Action:

Status:

Figure 4-38

To create or modify an IP Address Filtering entry, please follow these instructions:

1. **Effective Time** - Enter a range of time in HHMM format, which point to the range time for the entry to take effect. For example, 0803 - 1705, the entry will take effect from 08:03 to 17:05.
2. **LAN IP Address** - Enter a LAN IP Address or a range of LAN IP addresses in the field, in dotted-decimal notation format. For example, 192.168.1.20 - 192.168.1.30. Keep the field open, which means all LAN IP Addresses have been put into the field.
3. **LAN Port** - Enter a LAN Port or a range of LAN ports in the field. For example, 1030 - 2000. Keep the field open, which means all LAN ports have been put into the field.

4. **WAN IP Address** - Enter a WAN IP Address or a range of WAN IP Addresses in the field, in dotted-decimal notation format. For example, 61.145.238.6 – 61.145.238.47. Keep the field open, which means all WAN IP Addresses have been put into the field.
5. **WAN Port** - Enter a WAN Port or a range of WAN Ports in the field. For example, 25 – 110. Keep the field open, which means all WAN Ports have been put into the field.
6. **Protocol** - Select which protocol is to be used, either **TCP**, **UDP**, or **All** (all protocols supported by the router).
7. **Action** - Select either **Allow** or **Deny** through the router.
8. **Status** - Select **Enabled** or **Disabled** for this entry on the **Status** pull-down list.
9. Click the **Save** button to save this entry.

To modify or delete an existing entry:

1. Click the **Modify** in the entry you want to modify. If you want to delete the entry, click the **Delete**.
2. Modify the information.
3. Click the **Save** button.

Click the **Enable All** button to make all entries enabled

Click the **Disabled All** button to make all entries disabled.

Click the **Delete All** button to delete all entries

You can change the entry's order as desired. Fore entries are before hind entries. Enter the ID number in the first box you want to move and another ID number in second box you want to move to, and then click the **Move** button to change the entry's order.

Click the **Next** button to the next page and click the **Previous** button to return to the previous page.

For example: If you desire to block E-mail received and sent by the IP Address 192.168.1.7 on your local network, and to make the PC with IP Address 192.168.1.8 unable to visit the website of IP Address 202.96.134.12, while other PC(s) have no limit you should specify the following IP address filtering list:

ID	Effective time	LAN IP	LAN Port	WAN IP	WAN Port	Protocol	Action	Status	Modify
1	0000-2400	192.168.1.7	-	-	25	ALL	Deny	Enabled	Modify Delete
2	0000-2400	192.168.1.7	-	-	110	ALL	Deny	Enabled	Modify Delete
3	0000-2400	192.168.1.8	-	202.96.134.12	-	ALL	Deny	Enabled	Modify Delete

Figure 4-39

4.8.3 Domain Filtering

The Domain Filtering page (shown in Figure 4-40) allows you to control access to certain websites on the Internet by specifying their domains or key words.

Domain Filtering

Firewall Settings (You can change it on Firewall page)

Enable Firewall: **Enabled**

Enable Domain Filtering: **Disabled**

ID	Effective time	Domain Name	Status	Modify
----	----------------	-------------	--------	--------

Figure 4-40

Before adding a Domain Filtering entry, you must ensure that **Enable** Firewall and **Enable** Domain Filtering have been selected on the Firewall page. To Add a Domain filtering entry, click the **Add New...** button. The page "**Add or Modify a Domain Filtering entry**" will appear, shown in Figure 4-41:

Add or Modify a Domain Filtering entry

Effective time: -
 Domain Name:
 Status:

Figure 4-41

To add or modify a Domain Filtering entry, follow these instructions:

1. **Effective Time** - Enter a range of time in HHMM format specifying the time for the entry to take effect. For example, if you enter: 0803 - 1705, then the entry will take effect from 08:03 to 17:05.
2. **Domain Name** - Type the domain or key word as desired in the field. A blank in the domain field means all websites on the Internet. For example: www.xxyy.com.cn, .net.
3. **Status** - Select **Enabled** or **Disabled** for this entry on the **Status** pull-down list.
4. Click the **Save** button to save this entry.

To modify or delete an existing entry:

1. Click the **Modify** in the entry you want to modify. If you want to delete the entry, click the **Delete**.
2. Modify the information.
3. Click the **Save** button.

Click the **Enabled All** button to make all entries enabled.

Click the **Disabled All** button to make all entries disabled.

Click the **Delete All** button to delete all entries

Click the **Next** button to go to the next page and the **Previous** button to return to the previous page.

For example, if you want to block the PC(s) on your LAN to access websites www.xxyy.com.cn, www.aabbcc.com and websites with .net in the end on the Internet while no limit for other websites, you should specify the following Domain filtering list:

ID	Effective time	Domain Name	Status	Modify
1	0000-2400	www.xxyy.com	Enabled	Modify Delete
2	0800-2000	www.aabbcc.com	Enabled	Modify Delete
3	0000-2400	.net	Enabled	Modify Delete

Figure 4-42

4.8.4 MAC Filtering

Like the IP Address Filtering page, the MAC Address Filtering page (shown in Figure 4-43) allows you to control access to the Internet by users on your local network based on their MAC Address.

MAC Address Filtering

Firewall Settings (You can change it on Firewall page)

Enable Firewall: Enabled

Enable MAC Address Filtering: Disabled

Default Filtering Rules: Deny these PCs with enabled rules to access the Internet

ID	MAC Address	Description	Status	Modify
<div style="display: flex; justify-content: space-between; align-items: center;"> Add New... Enable All Disable All Delete All </div>				

Previous
Next

Figure 4-43

Before setting up MAC Filtering entries, you must ensure that **Enable** Firewall and **Enable** MAC Filtering have been selected on the Firewall page. To Add a MAC Address filtering entry, clicking the **Add New...** button. The page "Add or Modify a MAC Address Filtering entry" will appear, shown in Figure 4-44:

Add or Modify a MAC Address Filtering Entry

MAC Address:
Description:
Status:

Figure 4-44

To add or modify a MAC Address Filtering entry, follow these instructions:

1. Enter the appropriate MAC Address into the **MAC Address** field. The format of the MAC Address is XX-XX-XX-XX-XX-XX (X is any hexadecimal digit). For example: 00-0E-AE-B0-00-0B.
2. Type the description of the PC in the **Description** field. Fox example: John's PC.
3. **Status** - Select **Enabled** or **Disabled** for this entry on the **Status** pull-down list.
4. Click the **Save** button to save this entry.

To add additional entries, repeat steps 1-4.

When finished, click the **Return** button to return to the **MAC Address Filtering** page.

To modify or delete an existing entry:

1. Click the **Modify** in the entry you want to modify. If you want to delete the entry, click the **Delete**.
2. Modify the information.
3. Click the **Save** button.

Click the **Enable All** button to make all entries enabled.

Click the **Disabled All** button to make all entries disabled.

Click the **Delete All** button to delete all entries

Click the **Next** button to go to the next page and click the **Previous** button to return to the previous page.

Fox example: If you want to block the PC with MAC addresses 00-0A-EB-00-07-BE and 00-0A-EB-00-07-5F to access the Internet, first, enable the **Firewall** and **MAC Address Filtering** on the **Firewall** page, then, you should specify the Default MAC Address Filtering Rule "**Deny these PC(s) with effective rules to access the Internet**" on the Firewall page and the following MAC address filtering list on this page:

ID	MAC Address	Description	Status	Modify
1	00-0A-EB-00-07-BE	John's computer	Enabled	Modify Delete
2	00-0A-EB-00-07-5F	Alice's computer	Enabled	Modify Delete

Figure 4-45

4.8.5 Remote Management

You can configure the Remote Management function on this page shown in Figure 4-46. This feature allows you to manage your Router from a remote location, via the Internet.

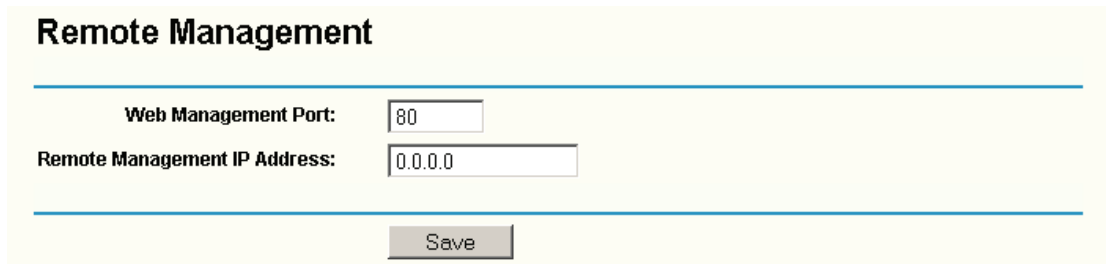

Remote Management

Web Management Port:

Remote Management IP Address:

Save

Figure 4-46

- **Web Management Port** - Web browser access normally uses the standard HTTP service port 80. This router's default remote management Web port number is 80. For greater security, you can change the remote management Web interface to a custom port by entering that number in this box provided. Choose a number between 1024 and 65534, but do not use the number of any common service port.
- **Remote Management IP Address** - This is the current address you will use when accessing your router from the Internet. The default IP Address is 0.0.0.0. It means this function is disabled. To enable this function, change the default IP Address to another IP Address as desired.

To access the router, you will type your router's WAN IP Address into your browser's Address (in IE) or Location (in Navigator) box, followed by a colon and the custom port number. For example, if your Router's WAN address is 202.96.12.8 and you use port number 8080, enter in your browser: <http://202.96.12.8:8080>. You will be asked for the router's password. After successfully entering the password, you will be able to access the router's Web-based utility.

 **Note:**

Be sure to change the router's default password to a very secure password.

4.8.6 Advanced Security

Using Advanced Security page (shown in Figure 4-47), you can protect the router from being attacked by TCP-SYN Flood, UDP Flood and ICMP-Flood from LAN.

Advanced Security

Packets Statistics Interval (5 ~ 60): Seconds

DoS Protection: Disable Enable

Enable ICMP-FLOOD Attack Filtering
ICMP-FLOOD Packets Threshold (5 ~ 3600): Packets/s

Enable UDP-FLOOD Filtering
UDP-FLOOD Packets Threshold (5 ~ 3600): Packets/s

Enable TCP-SYN-FLOOD Attack Filtering
TCP-SYN-FLOOD Packets Threshold (5 ~ 3600): Packets/s

Ignore Ping Packet From WAN Port
 Forbid Ping Packet From LAN Port

Figure 4-47

- **Packets Statistic interval (5 ~ 60)** - The default value is 10. Select a value between 5 and 60 seconds in the pull-down list. The **Packets Statistic interval** value indicates the time section of the packets statistic. The result of the statistic used for analysis by **SYN Flood**, **UDP Flood** and **ICMP-Flood**.
- **DoS protection - Enable or Disable** the DoS protection function. Only when it is enabled, will the flood filters be effective.
- **Enable ICMP-FLOOD Attack Filtering - Enable or Disable** the **ICMP-FLOOD** Attack Filtering.
- **ICMP-FLOOD Packets threshold: (5 ~ 3600)** - The default value is 50. Enter a value between 5 ~ 3600 packets. When the current **ICMP-FLOOD** Packets numbers is beyond the set value, the router will start up the blocking function immediately.
- **Enable UDP-FLOOD Filtering - Enable or Disable** the **UDP-FLOOD** Filtering.
- **UDP-FLOOD Packets threshold: (5 ~ 3600)** - The default value is 50. Enter a value between 5 ~ 3600 packets. When the current **UPD-FLOOD** Packets numbers is beyond the set value, the router will start up the blocking function immediately.
- **Enable TCP-SYN-FLOOD Attack Filtering - Enable or Disable** the **TCP-SYN- FLOOD** Attack Filtering.
- **TCP-SYN-FLOOD Packets threshold: (5 ~ 3600)** - The default value is 50. Enter a value between 5 ~ 3600 packets. When the current **TCP-SYN-FLOOD** Packets numbers is beyond the set value, the router will start up the blocking function immediately.
- **Ignore Ping Packet from WAN Port - Enable or Disable** ignore ping packet from WAN

port. The default is disabled. If enabled, the ping packet from the Internet cannot access the router.

- **Forbid Ping Packet from LAN Port** - Enable or Disable forbidding Ping Packet to access the router from the LAN port. The default value is disabled. If enabled, the ping packet from the LAN port cannot access the router. (Defends against some viruses)

Click the **Save** button to save the settings.

Click the **Blocked DoS Host Table** button to display the DoS host table by blocking. The page will appear that shown in Figure 4-48:

ID	Host IP Address	Host MAC Address	Modify
1	192.168.1.100	00-13-8F-AA-6D-77	Delete

Figure 4-48

This page shows **Host IP Address** and **Host MAC Address** for each host blocked by the router.

- **Host IP Address**- The IP address that blocked by DoS are displayed here.
- **Host MAC Address** - The MAC address that blocked by DoS are displayed here.

To update this page and to show the current blocked host, click on the **Refresh** button.

Click the **Clear All** button to clear all displayed entries. After the table is empty the blocked host will regain the capability to access Internet.

Click the **Return** button to return to the **Advanced Security** page

4.9 IP & MAC Binding Setting



Figure 4-49

There are two submenus under the IP &MAC Binding menu (shown in Figure 4-49): **Binding Setting** and **ARP List**. Click any of them, and you will be able to scan or configure the corresponding function. The detailed explanations for each submenu are provided below.

4.9.1 Binding Setting

This page displays the IP & MAC Binding Setting table; you can operate it in accord with your desire. (shown in Figure 4-50).

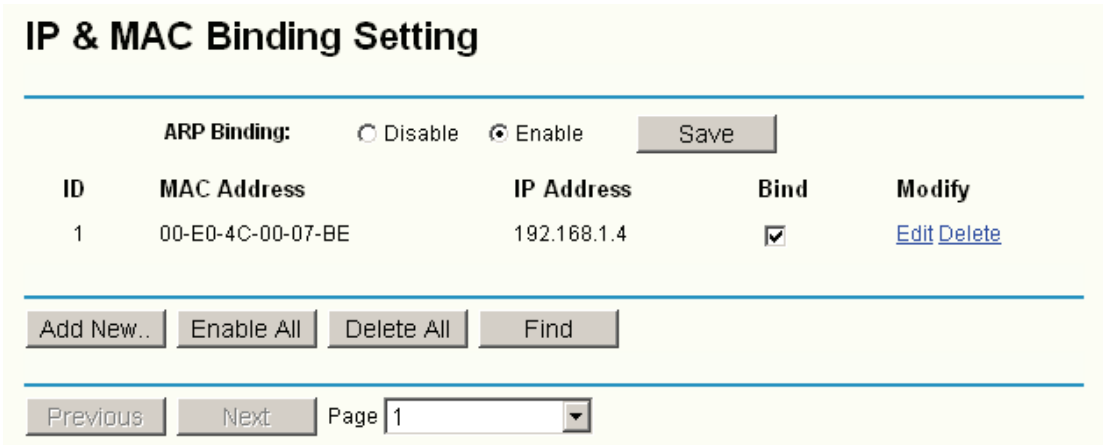

Figure 4-50

- **MAC Address** - The MAC address of the controlled computer in the LAN.
- **IP Address** - The assigned IP address of the controlled computer in the LAN.
- **Bind** - Whether or not enable the arp binding.
- **Modify** - Edit or delete item.

When you want to add or modify an IP & MAC Binding entry, you can click the **Add New** button or **Modify** button, and then you will go to the next page. This page is used for adding or modifying an IP & MAC Binding entry (shown in Figure 4-51).

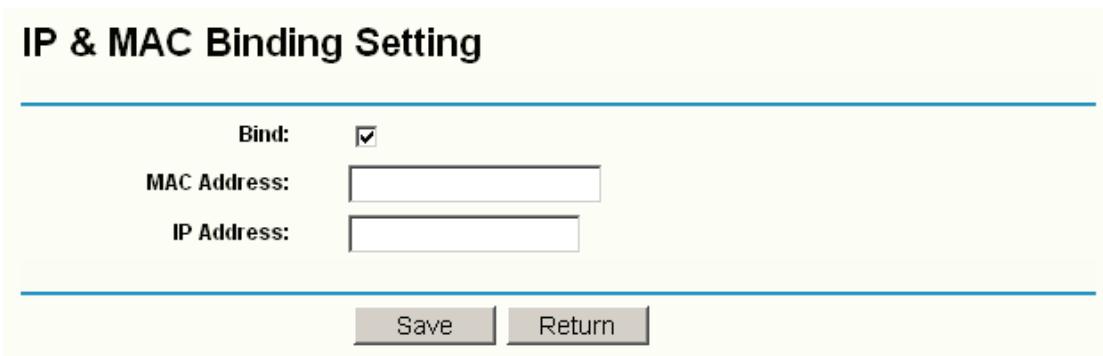

Figure 4-51

To add IP & MAC Binding entries:

1. Click the **Add New...** button.
2. Enter the MAC Address and IP Address.
3. Select the Bind checkbox.
4. Click the **Save** button to save it.

To modify or delete an existing entry:

1. Find the desired entry in the table.
2. Click **Modify** or **Delete** as desired on the **Modify** column.

To find an existing entry:

1. Click the **Find** button (shown in Figure 4-50).

2. Enter the MAC Address or IP Address.
3. Enter the **Find** button in the next page (shown in Figure 4-52).

Find IP & MAC Binding Entry

MAC Address:
IP Address:

ID	MAC Address	IP Address	Bind	Link
1	00-E0-4C-00-07-BE	192.168.1.4	<input checked="" type="checkbox"/>	Turn to this page

Figure 4-52

Click the **Enable All** button to make all entries enabled.

Click the **Delete All** button to delete all entries.

4.9.2 ARP List

To manage the computer, you could observe the computers in the LAN by checking the relationship of MAC address and IP address on the ARP list, and you could configure the items on the ARP list also. This page displays the ARP List; it shows all the existing IP & MAC Binding entries (shown in Figure 4-53).

ARP List

ID	MAC Address	IP Address	Status	Configure
1	00-E0-4C-00-07-BE	192.168.1.4	Bound	<input type="button" value="Load"/> <input type="button" value="Delete"/>
2	00-13-8F-AA-6D-77	192.168.1.161	UnBound	<input type="button" value="Load"/> <input type="button" value="Delete"/>

Figure 4-53

- **MAC Address** - The MAC address of the controlled computer in the LAN.
- **IP Address** - The assigned IP address of the controlled computer in the LAN.
- **Status** - Enabled or Disabled of the MAC address and IP address binding.
- **Configure** - Load or delete item.
- **Load** - Load the item to the IP & MAC Binding list.
- **Delete** - Delete the item.

Click the **Bind All** button to bind all the current items, available after enable.

Click the **Load All** button to load all items to the IP & MAC Binding list.

Click the **Refresh** button to refresh all items.

Note:

An item could not be loaded to the IP & MAC Binding list if the IP address of the item has been loaded before. Error warning will prompt as well. Likewise, "Load All" only loads the items without interference to the IP & MAC Binding list.

4.10 Static Routing

A static route is a pre-determined path that network information must travel to reach a specific host or network. To add or delete a route, work in the area under the Static Routing page (shown in Figure 4-54).

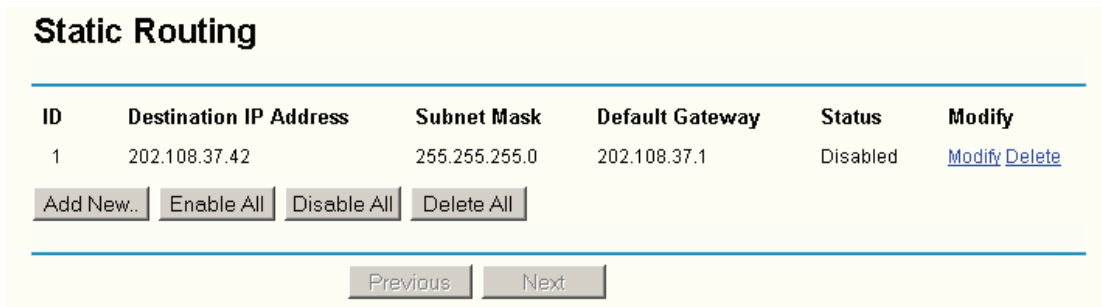

Figure 4-54

To add static routing entries:

1. Click the **Add New** button. (pop-up Figure 4-54)
2. Enter the following data:
 - **Destination IP Address** - The **Destination IP Address** is the address of the network or host that you want to assign to a static route.
 - **Subnet Mask** - The **Subnet Mask** determines which portion of an IP Address is the network portion, and which portion is the host portion.
 - **Gateway** - This is the IP Address of the gateway device that allows for contact between the router and the network or host.
3. Select **Enabled** or **Disabled** for this entry on the **Status** pull-down list.
4. Click the **Save** button to save it.

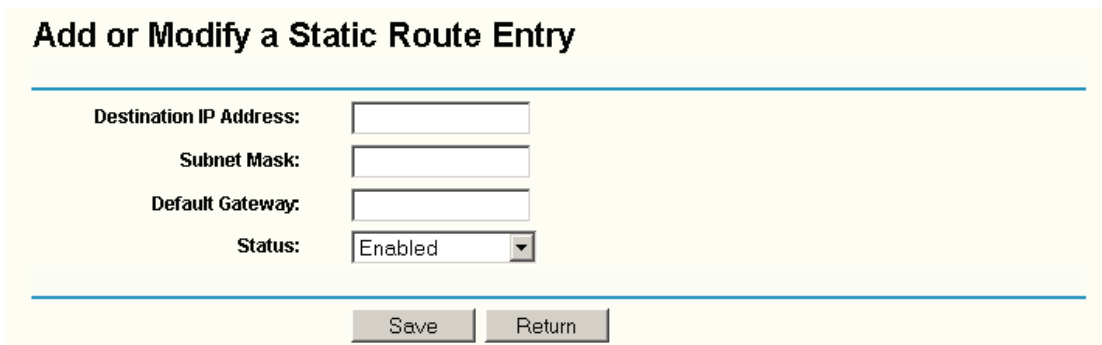

Figure 4-55

To modify or delete an existing entry:

- Click the **Modify** in the entry you want to modify. If you want to delete the entry, click the **Delete**.
- Modify the information.
- Click the **Save** button.

Click the **Enable All** button to make all entries enabled.

Click the **Disabled All** button to make all entries disabled.

Click the **Delete All** button to delete all entries

4.11 DDNS

The router offers a Dynamic Domain Name System (**DDNS**) feature. DDNS lets you assign a fixed host and domain name to a dynamic Internet IP Address. It is useful when you are hosting your own website, FTP server, or other server behind the router. Before using this feature, you need to sign up for DDNS service providers such as www.dyndns.org, www.oray.net or www.comexe.cn. The Dynamic DNS client service provider will give you a password or key.

To set up for DDNS, follow these instructions:

4.11.1 Dyndns.org DDNS

If your selected dynamic DNS **Service Provider** is www.dyndns.org, the page will appear as shown in Figure 4-56:

DDNS

Service Provider: Dyndns (www.dyndns.org) [Go to register...](#)

User Name:

Password:

Domain Name:

Enable DDNS

Connection Status: DDNS not launching !

Figure 4-56

To set up for DDNS, follow these instructions:

1. Type the **domain names** your dynamic DNS service provider gave.
2. Type the **User Name** for your DDNS account.
3. Type the **Password** for your DDNS account.

4. Click the **Login** button to login to the DDNS service.
 - **Connection Status** -The status of the DDNS service connection is displayed here.
- Click **Logout** to logout of the DDNS service.

4.11.2 Oray.net DDNS

If your selected dynamic DNS **Service Provider** is www.oray.net, the page will appear as shown in Figure 4-57:

The screenshot shows a web interface for configuring DDNS. At the top, the title is "DDNS". Below it, there is a "Service Provider" dropdown menu currently showing "PeanutHull (www.oray.net)" and a link "Go to register...". Underneath are two text input fields labeled "User Name:" and "Password:". To the right of these fields is a checkbox labeled "Enable DDNS" which is currently unchecked. Below the checkbox, the "Connection Status:" is displayed as "Disconnected!". Further down, "Service Type:" and "Domain Name:" are both shown as "---". At the bottom of the form area, there are three buttons: "Login", "Logout", and "Save".

Figure 4-57

To set up for DDNS, follow these instructions:

1. Type the **User Name** for your DDNS account.
 2. Type the **Password** for your DDNS account.
 3. Click the **Login** button to login the DDNS service.
 - **Connection Status** - The status of the DDNS service connection is displayed here.
 - **Domain Name** - The domain names are displayed here.
- Click **Logout** to logout the DDNS service.

4.11.3 Comexe.cn DDNS

If your selected dynamic DNS **Service Provider** is www.comexe.cn, the page will appear as shown in Figure 4-58:

Figure 4-58

To set up for DDNS, follow these instructions:

1. Type the **domain names** your dynamic DNS service provider gave.
 2. Type the **User Name** for your DDNS account.
 3. Type the **Password** for your DDNS account.
 4. Click the **Login** button to login to the DDNS service.
- **Connection Status** -The status of the DDNS service connection is displayed here.

Click **Logout** to logout of the DDNS service.

4.12 System Tools

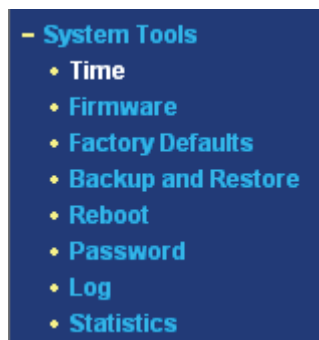

Figure 4-59

There are eight submenus under the System Tools menu (shown in Figure 4-59): **Time**, **Firmware**, **Factory Defaults**, **Backup and Restore**, **Reboot**, **Password**, **Log** and **Statistics**.

Click any of them, and you will be able to configure the corresponding function. The detailed explanations for each submenu are provided below.

4.12.1 Time

You can set time manually or get GMT from the Internet for the router on this page (shown in Figure 4-60):

Figure 4-60

- **Time Zone** - Select your local time zone from this pull down list.
- **Date** - Enter your local date in MM/DD/YY into the right blanks.
- **Time** - Enter your local time in HH/MM/SS into the right blanks.

Time setting follows these steps below:

1. Select your local time zone.
2. Enter date and time in the right blanks
3. Click **Save**.

Click the **Get GMT** button to get GMT time from Internet if you have connected to Internet.

If you're using Daylight saving time, please follow the steps below.

1. Select **using daylight saving time**.
2. Enter daylight saving beginning time and end time in the right blanks.
3. Click **Save**.

 **Note:**

- 1) This setting will be used for some time-based functions such as firewall. You must specify your time zone once you login to the router successfully, if not, the time limited on these functions will not take effect.
- 2) The time will be lost if the router is turned off.

3) The router will obtain GMT automatically from Internet if it has already connected to Internet.

4.12.2 Firmware

The page (shown in Figure 4-61) allows you to upgrade the latest version firmware to keep your router up-to-date.

Firmware

File:

Firmware Version: 3.3.0 Build 061104 Rel.6801n

Hardware Version: WR541G/542G v4 08140201

Figure 4-61

New firmware is posted at www.tp-link.com and can be downloaded for free. If the router is not experiencing difficulties, there is no need to upgrade firmware, unless the new firmware supports a new feature you need.

Note:

When you upgrade the router's firmware, you will lose current configuration settings, so make sure you backup the router's settings before you upgrade its firmware.

To upgrade the router's firmware, follow these instructions:

1. Download the latest firmware upgrade file from the TP-LINK website (www.tp-link.com).
 2. Click **Browse** to view the folders and select the downloaded file.
 3. Click the **Upgrade** button.
- **Firmware Version** - Displays the current firmware version.
 - **Hardware Version** - Displays the current hardware version. The hardware version of the upgrade file must accord with the current hardware version.

Note:

- 1) Do not turn off the router or press the Reset button while the firmware is being upgraded.
- 2) The router will reboot after the Upgrading has been finished.

4.12.3 Factory Defaults

This page (shown in Figure 4-62) allows you to restore the factory default settings for the router.

Factory Defaults

Click following button to reset all configuration settings to their default values

Figure 4-62

Click the **Restore** button to reset all configuration settings to their default values.

- The default **User Name**: admin
- The default **Password**: admin
- The default **IP Address**: 192.168.1.1
- The default **Subnet Mask**: 255.255.255.0

 **Note:**

Any settings you have saved will be lost when the default settings are restored.

4.12.4 Backup and Restore

This page (shown in Figure 4-63) allows you to save current configuration of router as backup or restore the configuration file you saved before.

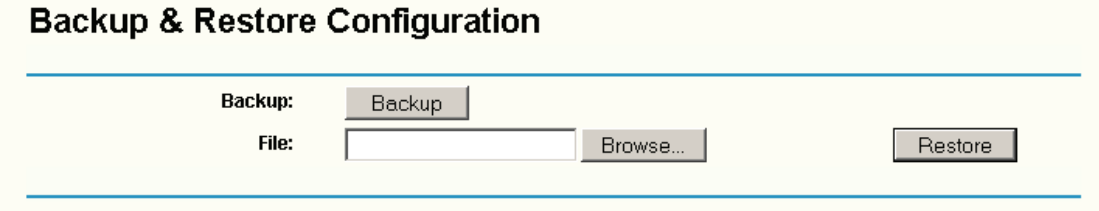

Figure 4-63

- Click the **Backup** button to save all configuration settings as a backup file in your local computer.
- To restore the router's configuration, follow these instructions:
 - Click the **Browse** button to select the backup file which you want to restore.
 - Click the **Restore** button.

 **Note:**

The current configuration will be covered with the uploading configuration file. The restoration process lasts for 20 seconds and the router will restart automatically. Keep the router on during the restoring process, to prevent any damage.

4.12.5 Reboot

This page (shown in Figure 4-64) allows you to reboot the router.

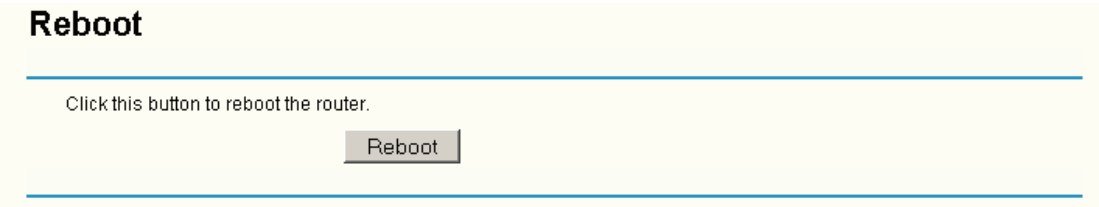

Figure 4-64

Click the **Reboot** button to reboot the router.

Some settings of the router will take effect only after rebooting, which include:

- Change LAN IP Address. (System will reboot automatically)
- MAC Clone (system will reboot automatically)
- DHCP service function.
- Static address assignment of DHCP server.
- Web Service Port of the router.
- Upgrade the firmware of the router (system will reboot automatically).
- Restore the router's settings to factory default (system will reboot automatically).

4.12.6 Password

This page (shown in Figure 4-65) allows you to change the factory default user name and password of the router.

Password

Old User Name:

Old Password:

New User Name:

New Password:

Confirm New Password:

Figure 4-65

It is recommended strongly that you change the factory default user name and password of the router. All users who try to access the router's Web-based utility or Quick Setup will be prompted for the router's user name and password.

Note:

The new user name and password must not exceed 14 characters in length and must not include any spaces. Enter the new Password twice to confirm it.

Click the **Save** button when finished.

Click the **Clear All** button to clear all.

4.12.7 Log

This page (shown in Figure 4-66) allows you to query the logs of the router.

Log

Index	Log
1	0000:System: Router initialization succeeded.

Time = 2006-01-01 8:00:09 9s
 H-Ver = WR541G/542G v4 08140201 : S-Ver = 3.3.0 Build 061104 Rel.6801n
 L = 192.168.1.1 : M = 255.255.255.0
 W1 = DHCP : W = 0.0.0.0 : M = 0.0.0.0 : G = 0.0.0.0
 Free=3097, Busy=1, Bind=0, Inv=0/0, Bc=0/0, Dns=0, cl=96, fc=0/0, sq=0/0

Figure 4-66

The router can keep logs of all traffic. You can query the logs to find what happened to the router.

Click the **Refresh** button to refresh the logs.

Click the **Clear Log** button to clear all the logs.

4.12.8 Statistics

The Statistics page (shown in Figure 4-67) displays the network traffic of each PC in LAN, including total traffic and traffic of the last **Packets Statistic interval** seconds.

Statistics

Current Statistics Status: **Enabled**

Packets Statistics Interval(5~60): Seconds Auto-refresh

Sorted Rules:

IP Address/ MAC Address	Total		Current				Modify	
	Packets	Bytes	Packets	Bytes	ICMP Tx	UDP Tx		SYN Tx
192.168.1.100 00-13-8F-AA-6D-77	1	58	0	0	0/0	0/0	0/0	Reset Delete

Figure 4-67

- **Current Statistics Status** - Enable or Disable. The default value is disabled. To enable, click the **Enable** button. If disabled, the function of DoS protection in Security settings will be ineffective.
- **Packets Statistics Interval** - The default value is 10. Select a value between 5 and 60 seconds in the pull-down list. The Packets Statistic interval indicates the time section of the packets statistic.
- **Sorted Rules** - Here displays sort as desired.

➤ **Statistics Table:**

IP Address		The IP Address displayed with statistics
Total	Packets	The total amount of packets received and transmitted by the router.
	Bytes	The total amount of bytes received and transmitted by the router.
Current	Packets	The total amount of packets received and transmitted in the last Packets Statistic interval seconds.
	Bytes	The total amount of bytes received and transmitted in the last Packets Statistic interval seconds.
	ICMP Tx	The total amount of the ICMP packets transmitted to WAN in the last Packets Statistic interval seconds.
	UDP Tx	The total amount of the UDP packets transmitted to WAN in the last Packets Statistic interval seconds.
	TCP SYN Tx	The total amount of the TCP SYN packets transmitted to WAN in the last Packets Statistic interval seconds.

Click the **Save** button to save the **Packets Statistic interval** value.

Click the **Auto-refresh** checkbox to refresh automatically.

Click the **Refresh** button to refresh immediately.

Appendix A: FAQ

1. How do I configure the router to access Internet by ADSL users?

- 1) First, configure the ADSL Modem configured in RFC1483 bridge model.
- 2) Connect the Ethernet cable from your ADSL Modem to the WAN port on the router. The telephone cord plugs into the Line port of the ADSL Modem.
- 3) Login to the router, click the "Network" menu on the left of your browser, and click "WAN" submenu. On the WAN page, select "PPPoE" for WAN Connection Type. Type user name in the "User Name" field and password in the "Password" field, finish by clicking "Connect".

The screenshot shows the WAN configuration interface. Under "WAN Connection Type:", a dropdown menu is set to "PPPoE". Below it, the "User Name:" field contains the text "username". The "Password:" field is filled with 12 black dots to mask the input.

Figure A-1

- 4) If your ADSL lease is in "pay-according-time" mode, select "Connect on Demand" or "Connect Manually" for Internet connection mode. Type an appropriate number for "Max Idle Time" to avoid wasting paid time. Otherwise, you can select "Auto-connecting" for Internet connection mode.

The screenshot displays the "Wan Connection Mode:" section. The "Connect on Demand" radio button is selected. Below it, "Max Idle Time:" is set to "15" minutes. The "Connect Automatically" and "Time-based Connecting" options are unselected. The "Time-based Connecting" section shows a "Period of Time" from "00:00" to "23:59". The "Connect Manually" option is also unselected, with its "Max Idle Time:" set to "15" minutes. At the bottom, there are "Connect" and "Disconnect" buttons.

Figure A-2

Note:

- 1) Sometimes the connection cannot be disconnected although you specify a time to Max Idle Time, since some applications is visiting the Internet continually in the background.
- 2) If you are a Cable user, please configure the router following the above steps.

2. How do I configure the router to access Internet by Ethernet users?

- 1) Login to the router, click the "Network" menu on the left of your browser, and click "WAN" submenu. On the WAN page, select "Dynamic IP" for "WAN Connection Type", finish by clicking "Save".
- 2) Some ISPs require that you register the MAC Address of your adapter, which is connected to your cable/DSL Modem during installation. If your ISP requires MAC register, login to the router and click the "Network" menu link on the left of your browser, and then click "MAC Clone" submenu link. On the "MAC Clone" page, if your PC's MAC address is proper MAC address, click the "Clone MAC Address" button and your PC's MAC address will fill in the "WAN MAC Address" field. Or else, type the MAC Address into the "WAN MAC Address" field. The format for the MAC Address is XX-XX-XX-XX-XX-XX. Then click the "Save" button. It will take effect after rebooting.

MAC Clone

WAN MAC Address:

Your PC's MAC Address:

Figure A-3

3. I want to use Netmeeting, what do I need to do?

- 1) If you start Netmeeting as a sponsor, you don't need to do anything with the router.
- 2) If you start as a response, you need to configure Virtual Server or DMZ Host.
- 3) How to configure Virtual Server: Login to the router, click the "Forwarding" menu on the left of your browser, and click "Virtual Servers" submenu. On the "Virtual Server" page, click **Add New**, then on the "Add or Modify a Virtual Server" page, enter "1720" into the blank behind the "Service Port", and your IP address behind the IP Address, assuming 192.168.1.169 for an example, remember to "Enable" and "Save".

Virtual Servers

ID	Service Port	IP Address	Protocol	Status	Modify
<input type="button" value="Add New.."/>	<input type="button" value="Enable All"/>	<input type="button" value="Disable All"/>	<input type="button" value="Delete All"/>		

Figure A-4

Add or Modify a Virtual Server Entry

Service Port:	<input type="text" value="1720"/> (0x-0x or 0x)
IP Address:	<input type="text" value="192.168.1.169"/>
Protocol:	<input type="text" value="ALL"/>
Status:	<input type="text" value="Enabled"/>
Common Service Port:	<input type="text" value="--Select One--"/>

Figure A-5

Note:

Your opposite side should call your WAN IP, which is displayed on the "Status" page.

- How to enable DMZ Host: Login to the router, click the "Forwarding" menu on the left of your browser, and click "DMZ" submenu. On the "DMZ" page, click "Enable" radio and type your IP address into the "DMZ Host IP Address" field, using 192.168.1.169 as an example, remember to click the "Save" button.

DMZ

Current DMZ Status:	<input type="radio"/> Enable <input checked="" type="radio"/> Disable
DMZ Host IP Address:	<input type="text" value="0.0.0.0"/>

Figure A-6

4. I want to build a WEB Server on the LAN, what should I do?

- Because the WEB Server port 80 will interfere with the WEB management port 80 on the router, you must change the WEB management port number to avoid interference.
- To change the WEB management port number: Login to the router, click the "Security" menu on the left of your browser, and click "Remote Management" submenu. On the "Remote Management" page, type a port number except 80, such as 88, into the "Web Management Port" field. Click "Save" and reboot the router.

Remote Management

Web Management Port:	<input type="text" value="80"/>
Remote Management IP Address:	<input type="text" value="0.0.0.0"/>

Figure A-7

Note:

If the above configuration takes effect, to configure to the router by typing <http://192.168.1.1:88> (the router's LAN IP address: Web Management Port) in the address field of the Web browser.

- 3) Login to the router, click the "Forwarding" menu on the left of your browser, and click the "Virtual Servers" submenu. On the "Virtual Server" page, click **Add New**, then on the "Add or Modify a Virtual Server" page, enter "80" into the blank behind the "Service Port", and your IP address behind the IP Address, assuming 192.168.1.188 for an example, remember to "Enable" and "Save".

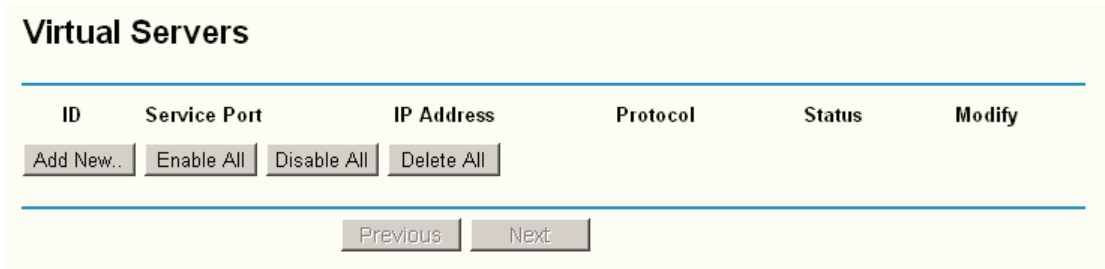

Figure A-8

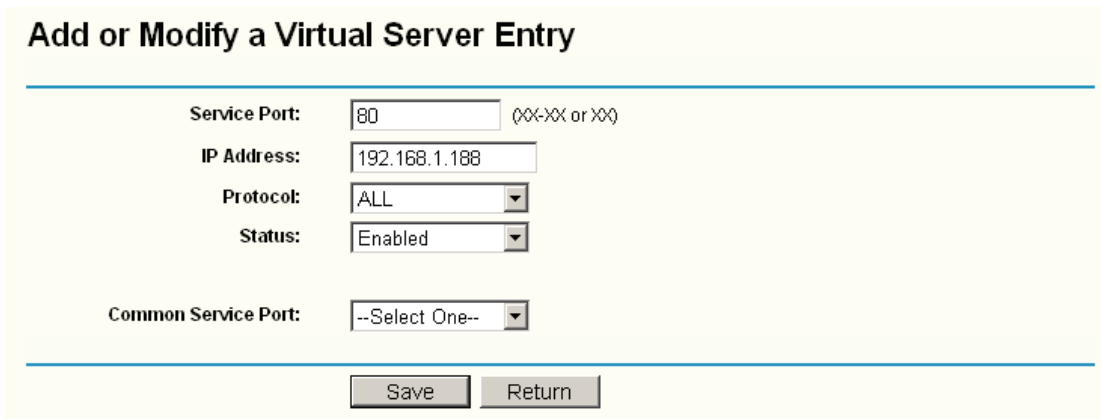

Figure A-9

5. The wireless stations cannot connect to the router.

- 1) Make sure the "Wireless Router Radio" is enabled.
- 2) Make sure that the wireless stations' SSID accord with the router's SSID.
- 3) Make sure the wireless stations have right KEY for encryption when the router is encrypted.
- 4) If the wireless connection is ready, but you can't access the router, check the IP Address of your wireless stations.

Appendix B: Configuring the PC

In this section, we'll introduce how to install and configure the TCP/IP correctly in Windows XP. First make sure your Ethernet Adapter is working, refer to the adapter's manual if needed.

1. Install TCP/IP component

- 1) On the Windows taskbar, click the **Start** button, point to **Settings**, and then click **Control Panel**.
- 2) Click the **Network and Internet Connections** icon, and then click on the **Network Connections** tab in the appearing window.
- 3) Right click the icon that showed below, select Properties on the prompt page.

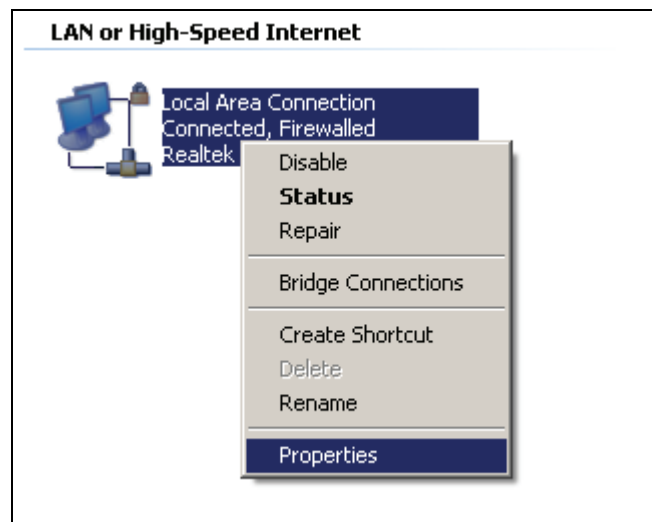

Figure 1

- 4) In the prompt page that showed below, double click on the **Internet Protocol (TCP/IP)**.

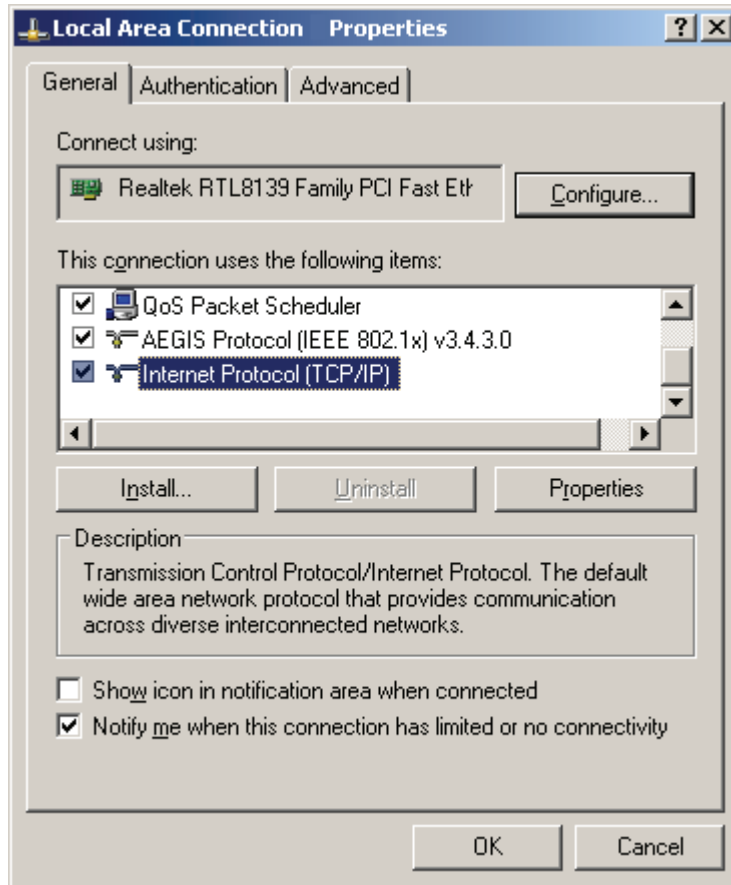

Figure 2

- 5) The following **TCP/IP Properties** window will display and the **IP Address** tab is open on this window by default.

Now you have two ways to configure the **TCP/IP** protocol below:

➤ **Setting IP address automatically**

Select **Obtain an IP address automatically**, Choose **Obtain DNS server automatically**, as shown in the Figure below:

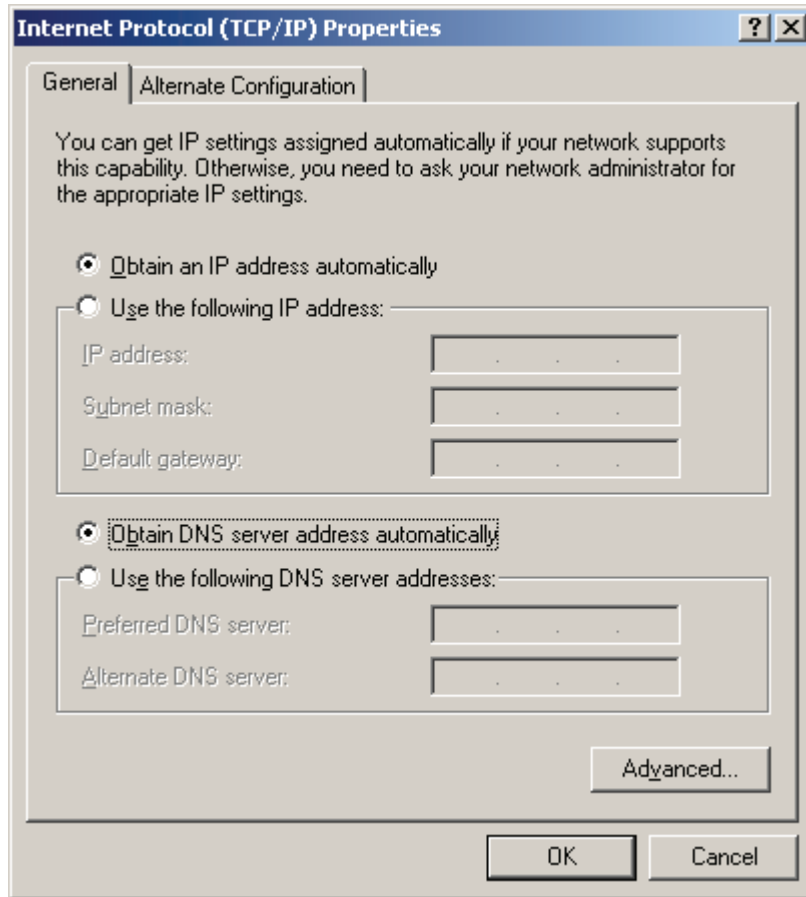

Figure 3

➤ Setting IP address manually

- 1 Select **Use the following IP address** radio button. And the following items available
- 2 If the router's LAN IP address is 192.168.1.1, type IP address is 192.168.1.x (x is from 2 to 254), and **Subnet mask** is 255.255.255.0.
- 3 Type the router's LAN IP address (the default IP is 192.168.1.1) into the **Default gateway** field.
- 4 Select **Use the following DNS server addresses** radio button. In the **Preferred DNS Server** field you can type the DNS server IP address, which has been provided by your ISP

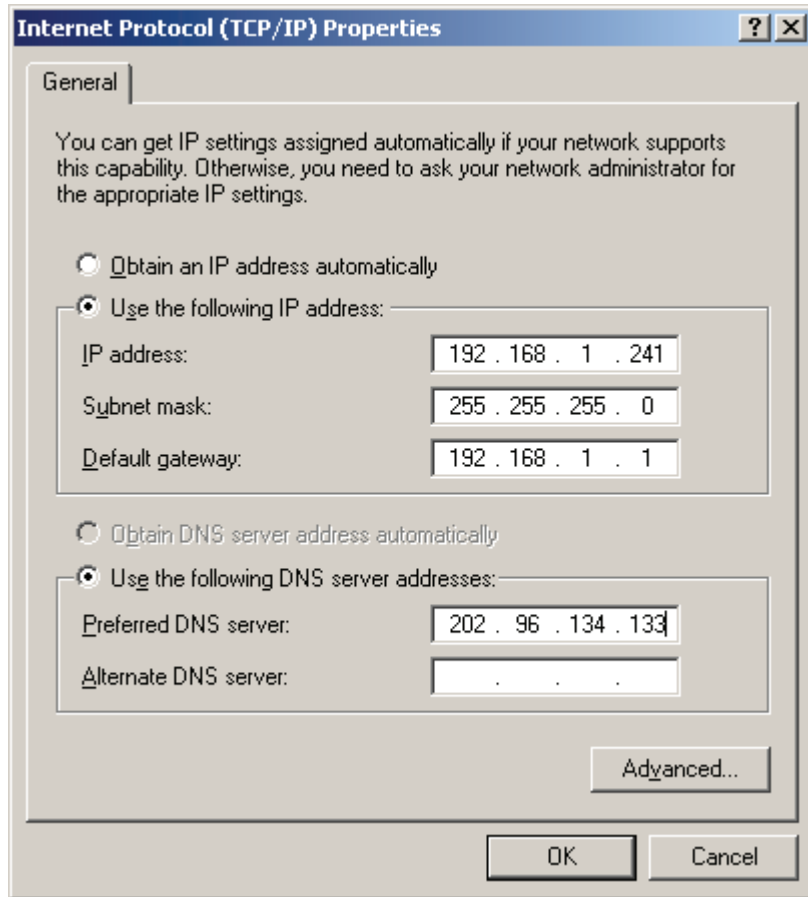

Figure 4

Appendix C: Specifications

General	
Standards	IEEE 802.3, 802.3u, 802.11b and 802.11g
Protocols	TCP/IP, PPPoE, DHCP, ICMP, NAT, SNTP
Ports	One 10/100M Auto-Negotiation WAN RJ45 port, Four 10/100M Auto-Negotiation LAN RJ45 ports supporting Auto MDI/MDIX
Cabling Type	10BASE-T: UTP category 3, 4, 5 cable (maximum 100m) EIA/TIA-568 100Ω STP (maximum 100m) 100BASE-TX: UTP category 5, 5e cable (maximum 100m) EIA/TIA-568 100Ω STP (maximum 100m)
Radio Data Rate	108/54/48/36/24/18/12/9/6Mbps or 11/5.5/3/2/1Mbps
LEDs	PWR, SYS, WLAN, WAN, 1, 2, 3, 4
Safety & Emissions	FCC, CE

Environmental and Physical	
Operating Temp.	0°C~40°C (32°F~104°F)
Operating Humidity	10% - 90% RH, Non-condensing
Dimensions (W×D×H)	6.9×4.4×1.2 in. (174×111×30 mm) (without antenna)

Appendix D: Glossary

- **108M Super G™ WLAN Transmission Technology** - 108M Super G™ WLAN Transmission Technology employs multiple performance-enhancing techniques including packet bursting, fast frames, data compression, and dynamic turbo mode that combine to improve the throughput and range of wireless networking products. Users can experience link rates of up to 108Mbps, twice the industry-standard maximum data link rate of 54Mbps, while preserving full compatibility with traditional 802.11g or 802.11b networks. 108M Super G™ products offer the highest throughput performance available on the market today. In dynamic 108M mode, the device can attach 802.11b, 802.11g and 108Mbps Super G™ devices at the same time in an integrated environment.
- **2x to 3x eXtended Range™ WLAN Transmission Technology** - The WLAN device with 2x to 3x eXtended Range™ WLAN transmission technology make its sensitivity up to 105 dB, which gives users the ability to have robust, longer-range wireless connections. With this range-enhancing technology, a 2x to 3x eXtended Range™ based client and access point can maintain a connection at as much as three times the transmission distance of traditional 802.11b and 802.11g products, for a coverage area that is up to nine times greater. A traditional 802.11b and 802.11g product transmission distance is about 300m, a 2x to 3x eXtended Range™ based client and access point can maintain a connection transmission distance may be up to 830m.
- **802.11b** - The 802.11b standard specifies a wireless networking at 11 Mbps using direct-sequence spread-spectrum (DSSS) technology and operating in the unlicensed radio spectrum at 2.4GHz, and WEP encryption for security. 802.11b networks are also referred to as Wi-Fi networks.
- **802.11g** - specification for wireless networking at 54 Mbps using direct-sequence spread-spectrum (DSSS) technology, using OFDM modulation and operating in the unlicensed radio spectrum at 2.4GHz, and backward compatibility with IEEE 802.11b devices, and WEP encryption for security.
- **DDNS (Dynamic Domain Name System)** - The capability of assigning a fixed host and domain name to a dynamic Internet IP Address.
- **DHCP (Dynamic Host Configuration Protocol)** - A protocol that automatically configure the TCP/IP parameters for the all the PC(s) that are connected to a DHCP server.
- **DMZ (Demilitarized Zone)** - A Demilitarized Zone allows one local host to be exposed to the Internet for a special-purpose service such as Internet gaming or videoconferencing.
- **DNS (Domain Name System)** – An Internet Service that translates the names of websites into

IP addresses.

- **Domain Name** - A descriptive name for an address or group of addresses on the Internet.
- **DoS (Denial of Service)** - A hacker attack designed to prevent your computer or network from operating or communicating.
- **DSL (Digital Subscriber Line)** - A technology that allows data to be sent or received over existing traditional phone lines.
- **ISP (Internet Service Provider)** - A company that provides access to the Internet.
- **MTU (Maximum Transmission Unit)** - The size in bytes of the largest packet that can be transmitted.
- **NAT (Network Address Translation)** - NAT technology translates IP addresses of a local area network to a different IP address for the Internet.
- **PPPoE (Point to Point Protocol over Ethernet)** - PPPoE is a protocol for connecting remote hosts to the Internet over an always-on connection by simulating a dial-up connection.
- **SSID** - A **S**ervice **S**et **I**dentification is a thirty-two character (maximum) alphanumeric key identifying a wireless local area network. For the wireless devices in a network to communicate with each other, all devices must be configured with the same SSID. This is typically the configuration parameter for a wireless PC card. It corresponds to the ESSID in the wireless Access Point and to the wireless network name.
- **WEP (Wired Equivalent Privacy)** - A data privacy mechanism based on a 64-bit or 128-bit or 152-bit shared key algorithm, as described in the IEEE 802.11 standard.
- **Wi-Fi** - A trade name for the 802.11b wireless networking standard, given by the Wireless Ethernet Compatibility Alliance (WECA, see <http://www.wi-fi.net>), an industry standards group promoting interoperability among 802.11b devices.
- **WLAN (Wireless Local Area Network)** - A group of computers and associated devices communicate with each other wirelessly, which network serving users are limited in a local area.

<http://www.tp-link.com>