

P-2612HNU-Fx

802.11n ADSL2+ VoIP IAD

User's Guide

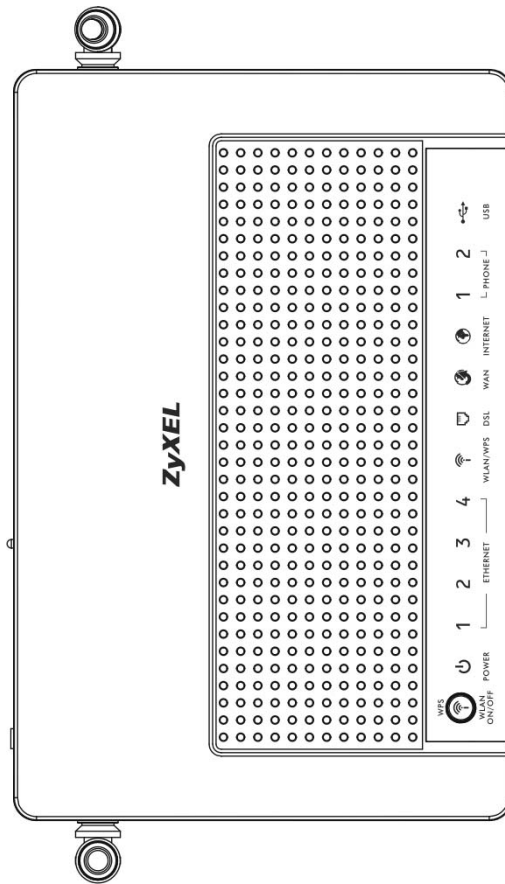

Default Login Details

IP Address	https://192.168.1.1
User Name	Admin account: admin User account: user
Password	Admin account: 1234 User account: 1234

Firmware Version 3.10
Edition 1, 9/2010

www.zyxel.com

ZyXEL

About This User's Guide

Intended Audience

This manual is intended for people who want to configure the ZyXEL Device using the web configurator.

Related Documentation

- Quick Start Guide

The Quick Start Guide is designed to help you get up and running right away. It contains information on setting up your network and configuring for Internet access.

- Support Disc

Refer to the included CD for support documents.

Documentation Feedback

Send your comments, questions or suggestions to: techwriters@zyxel.com.tw

Thank you!

The Technical Writing Team, ZyXEL Communications Corp.,
6 Innovation Road II, Science-Based Industrial Park, Hsinchu, 30099, Taiwan.

Need More Help?

More help is available at www.zyxel.com.

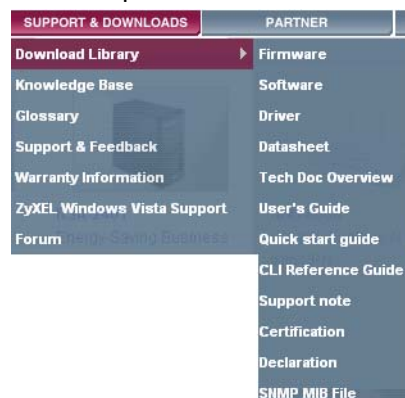

- Download Library

Search for the latest product updates and documentation from this link. Read the Tech Doc Overview to find out how to efficiently use the User Guide, Quick Start Guide and Command Line Interface Reference Guide in order to better understand how to use your product.

- Knowledge Base

If you have a specific question about your product, the answer may be here. This is a collection of answers to previously asked questions about ZyXEL products.

- Forum

This contains discussions on ZyXEL products. Learn from others who use ZyXEL products and share your experiences as well.

Customer Support

Should problems arise that cannot be solved by the methods listed above, you should contact your vendor. If you cannot contact your vendor, then contact a ZyXEL office for the region in which you bought the device.

See http://www.zyxel.com/web/contact_us.php for contact information. Please have the following information ready when you contact an office.

- Product model and serial number.
- Warranty Information.
- Date that you received your device.
- Brief description of the problem and the steps you took to solve it.

Document Conventions

Warnings and Notes

These are how warnings and notes are shown in this User's Guide.

Warnings tell you about things that could harm you or your device.









Note: Notes tell you other important information (for example, other things you may need to configure or helpful tips) or recommendations.

Syntax Conventions

- The P-2612HNU-Fx may be referred to as the "ZyXEL Device", the "device", the "system" or the "product" in this User's Guide.
- Product labels, screen names, field labels and field choices are all in **bold** font.
- A key stroke is denoted by square brackets and uppercase text, for example, [ENTER] means the "enter" or "return" key on your keyboard.
- "Enter" means for you to type one or more characters and then press the [ENTER] key. "Select" or "choose" means for you to use one of the predefined choices.
- A right angle bracket (>) within a screen name denotes a mouse click. For example, **Maintenance > Log > Log Setting** means you first click **Maintenance** in the navigation panel, then the **Log** sub menu and finally the **Log Setting** tab to get to that screen.
- Units of measurement may denote the "metric" value or the "scientific" value. For example, "k" for kilo may denote "1000" or "1024", "M" for mega may denote "1000000" or "1048576" and so on.
- "e.g.," is a shorthand for "for instance", and "i.e.," means "that is" or "in other words".

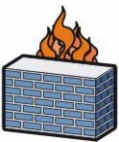
Icons Used in Figures

Figures in this User's Guide may use the following generic icons. The ZyXEL Device icon is not an exact representation of your device.

<p>ZyXEL Device</p> 	<p>Computer</p> 	<p>Notebook computer</p> 
<p>Server</p> 	<p>Firewall</p> 	<p>Telephone</p> 
<p>Router</p> 	<p>Switch</p> 	

Safety Warnings

- Do NOT use this product near water, for example, in a wet basement or near a swimming pool.
- Do NOT expose your device to dampness, dust or corrosive liquids.
- Do NOT store things on the device.
- Do NOT install, use, or service this device during a thunderstorm. There is a remote risk of electric shock from lightning.
- Connect ONLY suitable accessories to the device.
- Do NOT open the device or unit. Opening or removing covers can expose you to dangerous high voltage points or other risks. ONLY qualified service personnel should service or disassemble this device. Please contact your vendor for further information.
- Make sure to connect the cables to the correct ports.
- Place connecting cables carefully so that no one will step on them or stumble over them.
- Always disconnect all cables from this device before servicing or disassembling.
- Use ONLY an appropriate power adaptor or cord for your device.
- Connect the power adaptor or cord to the right supply voltage (for example, 110V AC in North America or 230V AC in Europe).
- Do NOT allow anything to rest on the power adaptor or cord and do NOT place the product where anyone can walk on the power adaptor or cord.
- Do NOT use the device if the power adaptor or cord is damaged as it might cause electrocution.
- If the power adaptor or cord is damaged, remove it from the device and the power source.
- Do NOT attempt to repair the power adaptor or cord. Contact your local vendor to order a new one.
- Do not use the device outside, and make sure all the connections are indoors. There is a remote risk of electric shock from lightning.
- Do NOT obstruct the device ventilation slots, as insufficient airflow may harm your device.
- Use only No. 26 AWG (American Wire Gauge) or larger telecommunication line cord.
- If you wall mount your device, make sure that no electrical lines, gas or water pipes will be damaged.

Your product is marked with this symbol, which is known as the WEEE mark. WEEE stands for Waste Electronics and Electrical Equipment. It means that used electrical and electronic products should not be mixed with general waste. Used electrical and electronic equipment should be treated separately.



Contents Overview

User's Guide	19
Introduction	21
Introducing the Web Configurator	29
Tutorials	37
Technical Reference	87
Connection Status and System Info Screens	89
Broadband	95
Wireless	123
Home Networking	153
Routing	181
DNS Route	185
Quality of Service (QoS)	189
Network Address Translation (NAT)	203
Dynamic DNS	211
Firewall	213
MAC Filter	219
Certificates	221
VoIP	229
Logs	259
System Monitor	263
User Account	271
Remote MGMT	273
System	275
Time Setting	277
Log Setting	279
Firmware Upgrade	281
Backup/Restore	283
Diagnostic	287
Troubleshooting	291
Product Specifications	301

Table of Contents

About This User's Guide	3
Document Conventions.....	5
Safety Warnings.....	7
Contents Overview	9
Table of Contents.....	11
Part I: User's Guide.....	19
Chapter 1	
Introduction.....	21
1.1 Overview	21
1.2 Applications for the ZyXEL Device	21
1.2.1 Internet Access	22
1.2.2 VoIP Features	23
1.2.3 ZyXEL Device's USB and DLNA Media Support	23
1.2.4 Wireless Connection	24
1.3 The WPS/WLAN Button	24
1.4 Ways to Manage the ZyXEL Device	25
1.5 Good Habits for Managing the ZyXEL Device	26
1.6 LEDs (Lights)	26
1.7 The RESET Button	28
Chapter 2	
Introducing the Web Configurator	29
2.1 Overview	29
2.1.1 Accessing the Web Configurator	29
2.2 The Web Configurator Layout	32
2.2.1 Title Bar	32
2.2.2 Main Window	33
2.2.3 Navigation Panel	33
Chapter 3	
Tutorials.....	37
3.1 Overview	37

3.2 Setting Up Your DSL Connection 37

3.3 How to Set up a Wireless Network 40

 3.3.1 Example Parameters 40

 3.3.2 Configuring the AP 40

 3.3.3 Configuring the Wireless Client 42

3.4 Setting Up NAT Port Forwarding 49

3.5 How to Make a VoIP Call 51

 3.5.1 VoIP Calls With a Registered SIP Account 51

3.6 Using the File Sharing Feature 54

 3.6.1 Set Up File Sharing 54

 3.6.2 Access Your Shared Files From a Computer 56

3.7 Using the Media Server Feature 57

 3.7.1 Configuring the ZyXEL Device 57

 3.7.2 Using Windows Media Player 58

 3.7.3 Using a Digital Media Adapter 61

3.8 Using the Print Server Feature 63

3.9 Configuring the MAC Address Filter 78

3.10 Configuring Static Route for Routing to Another Network 79

3.11 Configuring QoS Queue and Class Setup 81

3.12 Access the ZyXEL Device Using DDNS 84

 3.12.1 Registering a DDNS Account on www.dyndns.org 85

 3.12.2 Configuring DDNS on Your ZyXEL Device 86

 3.12.3 Testing the DDNS Setting 86

Part II: Technical Reference 87

**Chapter 4
Connection Status and System Info Screens..... 89**

4.1 Overview 89

4.2 The Connection Status Screen 89

4.3 The System Info Screen 91

**Chapter 5
Broadband..... 95**

5.1 Overview 95

 5.1.1 What You Can Do in this Chapter 96

 5.1.2 What You Need to Know 96

 5.1.3 Before You Begin 97

5.2 The Broadband Screen 98

 5.2.1 Add/Edit Internet Connection 99

5.3 The 3G Backup Screen 112

5.4 Technical Reference	114
Chapter 6	
Wireless	123
6.1 Overview	123
6.1.1 What You Can Do in this Chapter	123
6.1.2 Wireless Network Overview	123
6.1.3 Before You Begin	125
6.2 The Wireless General Screen	125
6.2.1 No Security	127
6.2.2 Basic (Static WEP/Shared WEP Encryption)	128
6.2.3 More Secure (WPA(2)-PSK)	130
6.2.4 WPA(2) Authentication	131
6.3 The More AP Screen	133
6.3.1 Edit More AP	134
6.4 The WPS Screen	135
6.5 The WMM Screen	137
6.6 Scheduling Screen	139
6.7 Technical Reference	139
6.7.1 Additional Wireless Terms	140
6.7.2 Wireless Security Overview	140
6.7.3 Signal Problems	143
6.7.4 BSS	143
6.7.5 MBSSID	144
6.7.6 WiFi Protected Setup (WPS)	145
Chapter 7	
Home Networking	153
7.1 Overview	153
7.1.1 What You Can Do in this Chapter	153
7.1.2 What You Need To Know	154
7.2 The LAN Setup Screen	157
7.3 The Static DHCP Screen	158
7.3.1 Before You Begin	158
7.4 The UPnP Screen	160
7.5 The File Sharing Screen	161
7.5.1 Before You Begin	161
7.5.2 Add/Edit File Sharing	163
7.6 The Media Server Screen	163
7.7 The Printer Server Screen	164
7.7.1 Before You Begin	165
7.8 Technical Reference	165
7.9 Installing UPnP in Windows Example	170

7.10 Using UPnP in Windows XP Example	173
Chapter 8	
Routing	181
8.1 Overview	181
8.2 Configuring Static Route	182
8.2.1 Add/Edit Static Route	183
Chapter 9	
DNS Route	185
9.1 Overview	185
9.1.1 What You Can Do in this Chapter	186
9.2 The DNS Route Screen	186
9.2.1 Add/Edit DNS Route Edit	187
Chapter 10	
Quality of Service (QoS).....	189
10.1 Overview	189
10.1.1 What You Can Do in this Chapter	189
10.1.2 What You Need to Know	190
10.2 The QoS General Screen	190
10.3 The Queue Setup Screen	192
10.3.1 Add/Edit a QoS Queue	193
10.4 The Class Setup Screen	194
10.4.1 Add/Edit QoS Class	195
10.5 The QoS Monitor Screen	198
10.6 QoS Technical Reference	199
10.6.1 IEEE 802.1Q Tag	199
10.6.2 IP Precedence	200
10.6.3 DiffServ	200
Chapter 11	
Network Address Translation (NAT).....	203
11.1 Overview	203
11.1.1 What You Can Do in this Chapter	203
11.1.2 What You Need To Know	203
11.2 The Port Forwarding Screen	204
11.2.1 The Port Forwarding Screen	205
11.2.2 The Port Forwarding Edit Screen	206
11.3 The Sessions Screen	207
11.4 Technical Reference	208
11.4.1 NAT Definitions	208
11.4.2 What NAT Does	209

11.4.3 How NAT Works	209
Chapter 12	
Dynamic DNS	211
12.1 Overview	211
12.1.1 What You Need To Know	211
12.2 The Dynamic DNS Screen	212
Chapter 13	
Firewall.....	213
13.1 Overview	213
13.1.1 What You Can Do in this Chapter	213
13.1.2 What You Need to Know	214
13.2 The General Screen	215
13.3 The Services Screen	215
13.4 Firewall Technical Reference	217
13.4.1 Guidelines For Enhancing Security With Your Firewall	217
13.4.2 Security Considerations	217
Chapter 14	
MAC Filter	219
14.1 Overview	219
14.1.1 What You Need to Know	219
14.2 The MAC Filter Screen	220
Chapter 15	
Certificates	221
15.1 Overview	221
15.1.1 What You Can Do in this Chapter	221
15.1.2 What You Need to Know	221
15.1.3 Verifying a Certificate	223
15.2 Local Certificates	224
15.3 Trusted CA	226
15.4 Trusted CA Import	227
15.5 View Certificate	228
Chapter 16	
VoIP	229
16.1 Overview	229
16.1.1 What You Can Do in this Chapter	229
16.1.2 What You Need to Know	230
16.1.3 Before You Begin	231
16.2 The SIP Service Provider Screen	231

16.3 The SIP Account Screen	235
16.3.1 Add/Edit SIP Account	237
16.4 Multiple SIP Accounts	240
16.4.1 Outgoing Calls	240
16.4.2 Incoming Calls	241
16.5 The Common Screen	242
16.6 The Phone Device Screen	243
16.6.1 Edit Phone Device	244
16.7 The Region Screen	245
16.8 The Call Rule Screen	245
16.9 Technical Reference	247
16.9.1 VoIP	247
16.9.2 SIP	247
16.9.3 Quality of Service (QoS)	253
16.9.4 Phone Services Overview	254
Chapter 17	
Logs	259
17.1 Overview	259
17.1.1 What You Can Do in this Chapter	259
17.2 The Phone Log Screen	259
17.3 The VoIP Call History Screen	260
Chapter 18	
System Monitor	263
18.1 Overview	263
18.1.1 What You Can Do in this Chapter	263
18.2 The WAN Status Screen	264
18.3 The LAN Status Screen	265
18.4 The NAT Status Screen	266
18.5 The 3G Backup Status Screen	266
18.6 The VoIP Status Screen	267
Chapter 19	
User Account.....	271
19.1 Overview	271
19.2 The User Account Screen	271
Chapter 20	
Remote MGMT.....	273
20.1 Overview	273
20.1.1 What You Need to Know	273
20.2 The Remote MGMT Screen	274

Chapter 21	
System	275
21.1 Overview	275
21.1.1 What You Need to Know	275
21.2 The System Screen	275
Chapter 22	
Time Setting	277
22.1 Overview	277
22.2 The Time Setting Screen	277
Chapter 23	
Log Setting	279
23.1 Overview	279
23.2 The Log Setting Screen	279
Chapter 24	
Firmware Upgrade	281
24.1 Overview	281
24.2 The Firmware Upgrade Screen	281
Chapter 25	
Backup/Restore	283
25.1 Overview	283
25.2 The Backup/Restore Screen	283
25.3 The Reboot Screen	285
Chapter 26	
Diagnostic	287
26.1 Overview	287
26.1.1 What You Can Do in this Chapter	287
26.2 The Ping Screen	287
26.3 The DSL Line Screen	288
Chapter 27	
Troubleshooting	291
27.1 Overview	291
27.2 Power, Hardware Connections, and LEDs	291
27.3 ZyXEL Device Access and Login	292
27.4 Internet Access	294
27.5 Wireless Internet Access	296
27.6 Phone Calls and VoIP	298
27.7 USB Device Connection	298

27.8 UPnP 299

Chapter 28

Product Specifications 301

Appendix A IP Addresses and Subnetting 311

Appendix B Setting Up Your Computer's IP Address 323

Appendix C Pop-up Windows, JavaScript and Java Permissions..... 353

Appendix D Wireless LANs 363

Appendix E Common Services..... 387

Appendix F Open Software Announcements 391

Appendix G Legal Information 415

Index..... 417

PART I

User's Guide

Introduction

1.1 Overview

The ZyXEL Device is an ADSL2+ Integrated Access Device (IAD) that combines an ADSL2+ router with Voice over IP (VoIP) communication capabilities to allow you to use a traditional analog telephone to make Internet calls. By integrating DSL and NAT, you are provided with ease of installation and high-speed, shared Internet access. The ZyXEL Device is also a complete security solution with a robust firewall.

Please refer to the following description of the product name format.

- “H” denotes an integrated 4-port hub (switch).
- “N” denotes wireless functionality, including 802.11n mode. There is an embedded mini-PCI module for IEEE 802.11 a/b/g/n wireless LAN connectivity.
- “U” denotes a USB port used to set up a 3G WAN connection via a 3G wireless card or share files via a USB memory stick or a USB hard drive. The ZyXEL Device can function as a print server with an USB printer connected. It can also function as a DLNA/media server.
- Models ending in “1”, for example P-2612HNU-F1, denote a device that works over the analog telephone system, POTS (Plain Old Telephone Service). Models ending in “3” denote a device that works over ISDN (Integrated Services Digital Network) or T-ISDN (UR-2).

Only use firmware for your ZyXEL Device’s specific model. Refer to the label on the bottom of your ZyXEL Device.

See the chapter on product specifications for a full list of features.

1.2 Applications for the ZyXEL Device

Here are some example uses for which the ZyXEL Device is well suited.

1.2.1 Internet Access

Your ZyXEL Device provides shared Internet access by connecting the DSL port to the **DSL** or **MODEM** jack on a splitter or your telephone jack. If you prefer not to use a DSL line and you have another broadband modem or router (such as ADSL) available, you can push the **DSL/WAN** switch (on the rear panel) to the **WAN** side and connect the **WAN** port to the broadband modem or router. This way, you can access the Internet via an Ethernet connection and still use the QoS, Firewall and VoIP functions on the ZyXEL Device.

Computers can connect to the ZyXEL Device's LAN ports (or wirelessly).

Figure 1 ZyXEL Device's Internet Access Application

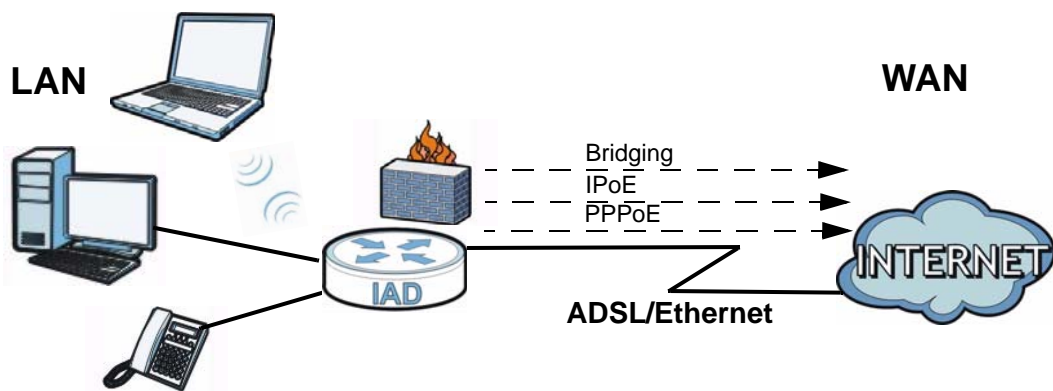

1.2.1.1 3G WAN

The USB port allows you to wirelessly connect to a 3G network to get Internet access by attaching a 3G wireless card. You must leave the DSL or Ethernet WAN port unconnected and attached a 3G wireless card to use 3G as your WAN. You can also have the ZyXEL Device use the 3G WAN connection as a backup. That means the ZyXEL Device switches to the 3G wireless WAN connection after the wired DSL or Ethernet WAN connection fails. The ZyXEL Device automatically changes back to use the wired DSL or Ethernet WAN connection when it is available.

Figure 2 Internet Access Application: 3G WAN

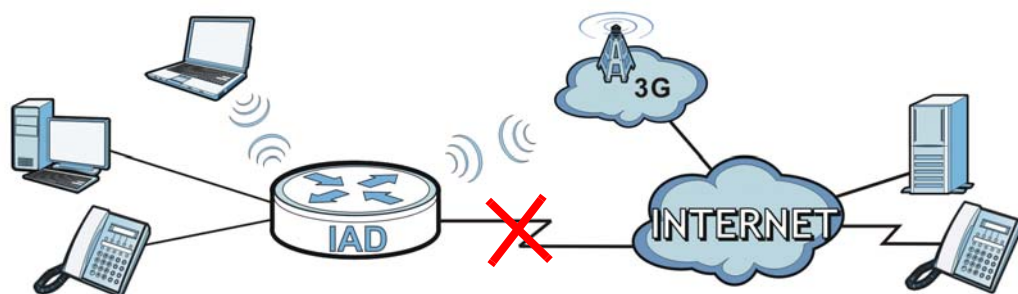

You can also configure firewall on the ZyXEL Device for secure Internet access. When the firewall is on, all incoming traffic from the Internet to your network is blocked unless it is initiated from your network. This means that probes from the outside to your network are not allowed, but you can safely browse the Internet and download files.

Use QoS to efficiently manage traffic on your network by giving priority to certain types of traffic and/or to particular computers. For example, you could make sure that the ZyXEL Device gives voice over Internet calls high priority, and/or limit bandwidth devoted to the boss's excessive file downloading.

1.2.2 VoIP Features

You can register up to 2 SIP (Session Initiation Protocol) profiles (4 accounts for each profile) and use the ZyXEL Device to make and receive VoIP telephone calls:

Figure 3 ZyXEL Device's VoIP Application

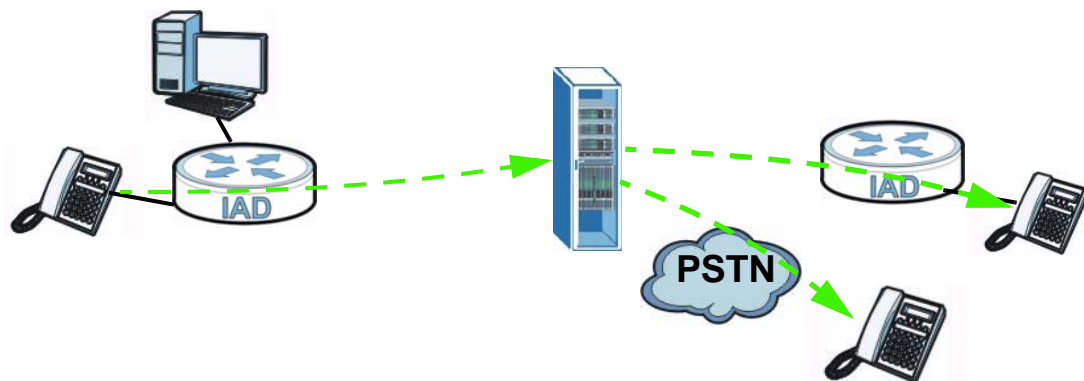

The ZyXEL Device sends your call to a VoIP service provider's SIP server which forwards your calls to either VoIP or PSTN phones.

1.2.3 ZyXEL Device's USB and DLNA Media Support

Use the built-in USB 2.0 port to share files via a USB memory stick or a USB hard drive (**A**). Alternatively, you can add a USB printer (**B**) and make it available on your local area network.

You can also use the ZyXEL Device with a hardware-based media client (C) to play media files stored in the USB storage device in your TV screen.

Figure 4 USB File Sharing, Print Server, and Media Server Application

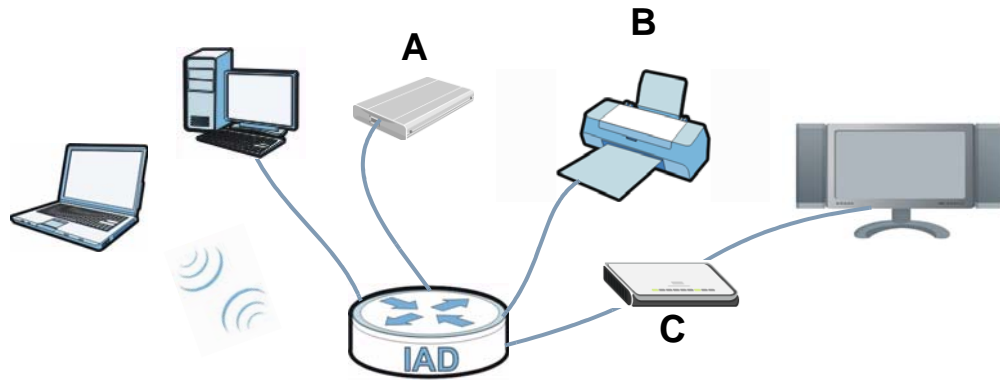

1.2.4 Wireless Connection

By default, the wireless LAN (WLAN) is enabled on the ZyXEL Device. IEEE 802.11a/b/g/n compliant clients can wirelessly connect to the ZyXEL Device to access network resources. You can set up a wireless network with WPS (WiFi Protected Setup) or manually add a client to your wireless network.

Figure 5 Wireless Connection Application

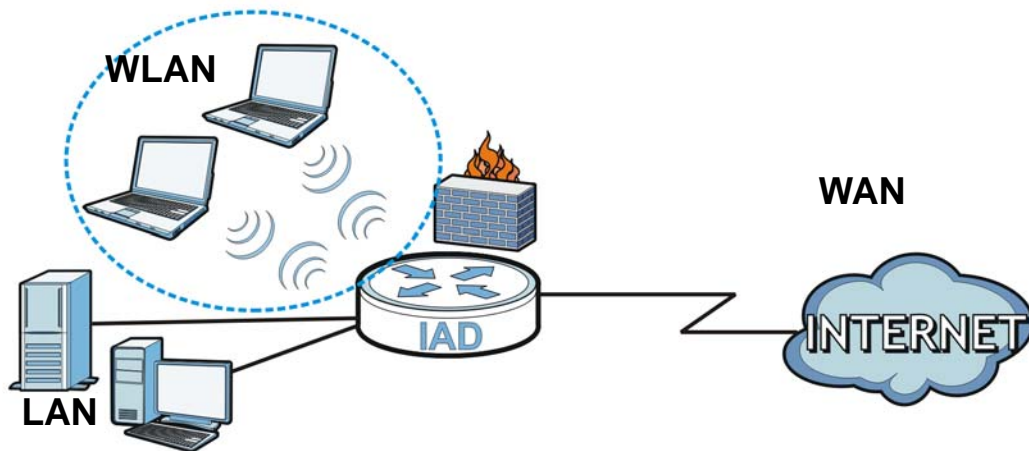

1.3 The WPS/WLAN Button

You can use the **WPS** button (📶) on the top of the device to turn the wireless LAN off or on. You can also use it to activate WPS in order to quickly set up a wireless network with strong security.

Turn the Wireless LAN Off or On

- 1 Make sure the **POWER** LED is on (not blinking).
- 2 Press the **WPS** button for one second and release it. The **WLAN/WPS** LED should change from on to off or vice versa.

Activate WPS

- 1 Make sure the **POWER** LED is on (not blinking).
- 2 Press the **WPS** button for more than five seconds and release it. Press the WPS button on another WPS -enabled device within range of the ZyXEL Device. The **WLAN/WPS** LED should flash while the ZyXEL Device sets up a WPS connection with the wireless device.

Note: You must activate WPS in the ZyXEL Device and in another wireless device within two minutes of each other. See [Chapter 6 on page 145](#) for more information.

1.4 Ways to Manage the ZyXEL Device

Use any of the following methods to manage the ZyXEL Device.

- Web Configurator. This is recommended for everyday management of the ZyXEL Device using a (supported) web browser.
- Command Line Interface. Line commands are mostly used for troubleshooting by service engineers.
- FTP for firmware upgrades and configuration backup/restore.

1.5 Good Habits for Managing the ZyXEL Device

Do the following things regularly to make the ZyXEL Device more secure and to manage the ZyXEL Device more effectively.

- Change the password. Use a password that's not easy to guess and that consists of different types of characters, such as numbers and letters.
- Write down the password and put it in a safe place.
- Back up the configuration (and make sure you know how to restore it). Restoring an earlier working configuration may be useful if the device becomes unstable or even crashes. If you forget your password, you will have to reset the ZyXEL Device to its factory default settings. If you backed up an earlier configuration file, you would not have to totally re-configure the ZyXEL Device. You could simply restore your last configuration.

1.6 LEDs (Lights)

The following graphic displays the labels of the LEDs.

Figure 6 LEDs on the Top of the Device

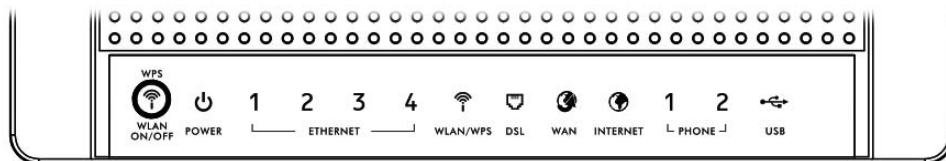

None of the LEDs are on if the ZyXEL Device is not receiving power.

Table 1 LED Descriptions

LED	COLOR	STATUS	DESCRIPTION
POWER	Green	On	The ZyXEL Device is receiving power and ready for use.
		Blinking	The ZyXEL Device is self-testing.
	Red	On	The ZyXEL Device detected an error while self-testing, or there is a device malfunction.
	Off		The ZyXEL Device is not receiving power.
ETHERNET 1-4	Green	On	The ZyXEL Device has an Ethernet connection with a device on the Local Area Network (LAN).
		Blinking	The ZyXEL Device is sending/receiving data to/from the LAN.
	Off		The ZyXEL Device does not have an Ethernet connection with the LAN.

Table 1 LED Descriptions

LED	COLOR	STATUS	DESCRIPTION
WLAN/ WPS	Green	On	The wireless network is activated and is operating in IEEE 802.11 mode.
		Blinking	The ZyXEL Device is communicating with other wireless clients.
	Orange	Blinking	The WPS connection is being configured.
	Off		The wireless network is not activated.
DSL	Green	On	This light applies when the ZyXEL Device is in DSL WAN mode. The DSL line is up.
		Blinking	The ZyXEL Device is attempting to synchronize DSL signal.
	Off		The DSL line is down.
WAN	Green	On	This light applies when the ZyXEL Device is in Ethernet WAN mode. The ZyXEL Device has an Ethernet connection with a device on the WAN.
		Blinking	The ZyXEL Device is sending/receiving data to/from the WAN.
	Off		The ZyXEL Device does not have an Ethernet connection with the WAN.
INTERNET	Green	On	The ZyXEL Device has an IP connection but no traffic. Your device has a WAN IP address (either static or assigned by a DHCP server), PPP negotiation was successfully completed (if used).
		Blinking	The ZyXEL Device is sending or receiving IP traffic.
	Red	On	The ZyXEL Device attempted to make an IP connection but failed. Possible causes are no response from a DHCP server, no PPPoE response, PPPoE authentication failed.
	Off		The ZyXEL Device does not have an IP connection.
PHONE	Green	On	A SIP account is registered for the phone port.
		Blinking	A telephone connected to the phone port has its receiver off of the hook or there is an incoming call.
	Orange	On	A SIP account is registered for the phone port and there is a voice message in the corresponding SIP account.
		Blinking	A telephone connected to the phone port has its receiver off of the hook and there is a voice message in the corresponding SIP account.
	Off		The phone port does not have a SIP account registered.
USB	Green/ Orange	On	The ZyXEL Device recognizes a USB connection but there is no traffic.
		Blinking	The ZyXEL Device is sending/receiving data to /from the USB device connected to it.
	Off		The ZyXEL Device does not detect a USB connection.

Refer to the Quick Start Guide for information on hardware connections.

1.7 The RESET Button

If you forget your password or cannot access the web configurator, you will need to use the **RESET** button at the back of the device to reload the factory-default configuration file. This means that you will lose all configurations that you had previously and the passwords will be reset to the defaults.

- 1 Make sure the **POWER** LED is on (not blinking).
- 2 To set the device back to the factory default settings, press the **RESET** button for 5 seconds or until the **POWER** LED begins to blink and then release it. When the **POWER** LED begins to blink, the defaults have been restored and the device restarts.

Introducing the Web Configurator

2.1 Overview

The web configurator is an HTML-based management interface that allows easy device setup and management via Internet browser. Use Internet Explorer 6.0 and later versions, Mozilla Firefox 3 and later versions, or Safari 2.0 and later versions. The recommended screen resolution is 1024 by 768 pixels.

In order to use the web configurator you need to allow:

- Web browser pop-up windows from your device. Web pop-up blocking is enabled by default in Windows XP SP (Service Pack) 2.
- JavaScript (enabled by default).
- Java permissions (enabled by default).

See [Appendix C on page 353](#) if you need to make sure these functions are allowed in Internet Explorer.

2.1.1 Accessing the Web Configurator

- 1 Make sure your ZyXEL Device hardware is properly connected (refer to the Quick Start Guide).
- 2 Launch your web browser.
- 3 Type "192.168.1.1" as the URL.
- 4 A password screen displays. Type "admin" or "user" (default) as the account username and "1234" as the password, and click **Login**. Some features are not configurable with the user account.

If you have changed the password, enter your password and click **Login**.

Figure 7 Password Screen

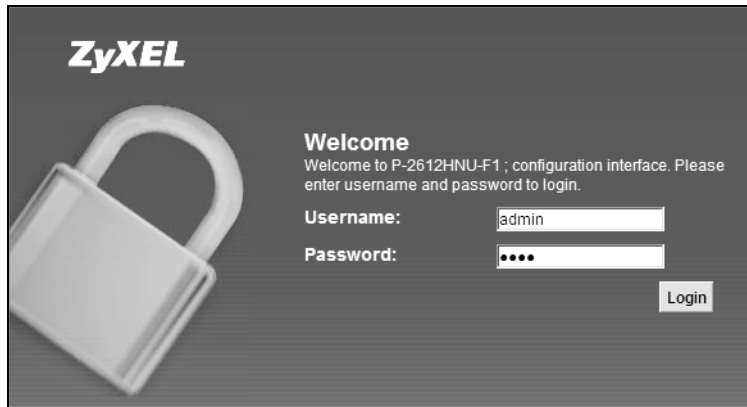

Note: For security reasons, the ZyXEL Device automatically logs you out if you do not use the web configurator for five minutes (default). If this happens, log in again.

- 5 The following screen displays if you have not yet changed your password. It is strongly recommended you change the default password. Enter a new password, retype it to confirm and click **Apply**; alternatively click **Skip** to proceed to the main menu if you do not want to change the password now.

Figure 8 Change Password Screen

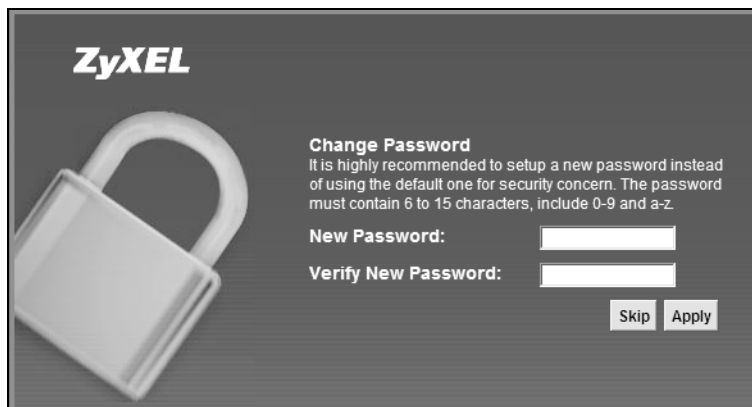

- 6 The **Connection Status** screen appears.

Figure 9 Connection Status

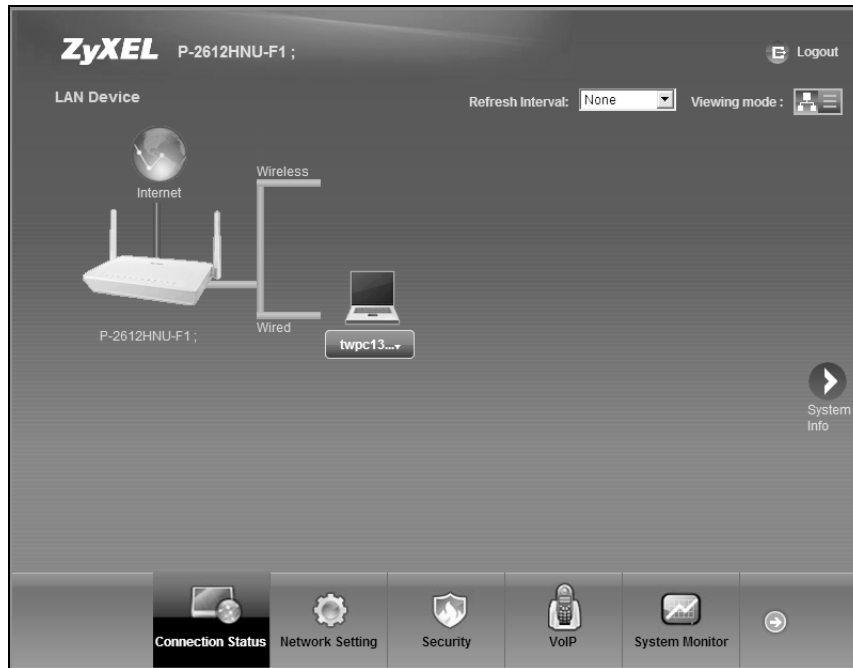

- 7 Click **System Info** to display the **System Info** screen, where you can view the ZyXEL Device's interface and system information.

2.2 The Web Configurator Layout

Click **Connection Status > System Info** to show the following screen.

Figure 10 Web Configurator Layout

The screenshot shows the ZyXEL P-2612HNU-F1 Web Configurator interface. The page is titled "System Info" and contains several sections:

- Device Information:** Host Name: P-2612HNU-F1, Model Name: P-2612HNU-F1, MAC Address: 40:44:03:5b:a3, Firmware Version: V3.10(BLT.0)h2, WAN Information (ETHER WAN): Mode: PoE.
- LAN Information:** IP Address: 192.168.1.1, IP Subnet Mask: 255.255.255.0, DHCP Server: Server.
- WLAN Information:** Channel: 1, WPS Status: Unconfigured.
- SSID1 Information:** SSID: ZwiEL, Status: On, Security Mode: WPA2-PSK mix.
- SSID2 Information:** SSID: ZwiEL2, Status: Off, Security Mode: WPA2-PSK mix.
- SSID3 Information:** SSID: ZwiEL3, Status: Off, Security Mode: WPA2-PSK mix.
- SSID4 Information:** SSID: ZwiEL4, Status: Off, Security Mode: WPA2-PSK mix.
- Interface Status:**

Interface	Status	Rate
ETHER WAN	Down	N/A
LAN 1	Up	1000Mbps
LAN 2	Down	N/A
LAN 3	Down	N/A
LAN 4	Down	N/A
WLAN	Up	300Mbps
3G	Disabled	N/A
- System Status:** System Up Time: 7 min, Current Date/Time: Sat Jan 1 00:07:47 UTC 2000, System Resource: CPU Usage: 2.0%, Memory Usage: 67.3%, Power Usage: 4W, 14W.
- USB Status:**

Type	Status
Storage	N/A
Printer	N/A
- Registration Status:**

Account	Action	Account Status	URI
SIP 1	Registers	In-Active	ChangeMe@ChangeMe
SIP 2	Registers	In-Active	ChangeMe@ChangeMe

The navigation panel (C) at the bottom includes icons for Connection Status, Network Setting, Security, VoIP, and System Monitor.

As illustrated above, the main screen is divided into these parts:

- **A** - title bar
- **B** - main window
- **C** - navigation panel

2.2.1 Title Bar

The title bar shows the following icon in the upper right corner.



Click this icon to log out of the web configurator.

2.2.2 Main Window

The main window displays information and configuration fields. It is discussed in the rest of this document.

After you click **System Info** on the **Connection Status** screen, the **System Info** screen is displayed. See [Chapter 4 on page 91](#) for more information about the **System Info** screen.

If you click **LAN Device** on the **System Info** screen, the **Connection Status** screen appears. See [Chapter 4 on page 89](#) for more information about the **Connection Status** screen.

If you click **Virtual Device** on the **System Info** screen, a visual graphic appears, showing the connection status of the ZyXEL Device's ports. The connected ports are in color and disconnected ports are gray.

2.2.3 Navigation Panel

Use the menu items on the navigation panel to open screens to configure ZyXEL Device features. The following table describes each menu item.

Table 2 Navigation Panel Summary

LINK	TAB	FUNCTION
Connection Status		This screen shows the network status of the ZyXEL Device and computers/devices connected to it.
Network Setting		
Broadband	Broadband	Use this screen to view, remove or add a WAN interface. You can also configure ISP parameters, WAN IP address assignment, DNS servers and other advanced properties.
	3G Backup	Use this screen to configure the 3G WAN connection.
Wireless	General	Use this screen to turn the wireless connection on or off, specify the SSID(s) and configure the wireless LAN settings and WLAN authentication/security settings.
	More AP	Use this screen to configure multiple BSSs on the ZyXEL Device.
	WPS	Use this screen to use WPS (Wi-Fi Protected Setup) to establish a wireless connection.
	WMM	Use this screen to enable or disable Wi-Fi MultiMedia (WMM).
	Scheduling	Use this screen to configure when the ZyXEL Device enables or disables the wireless LAN.

Table 2 Navigation Panel Summary (continued)

LINK	TAB	FUNCTION
Home Networking	LAN Setup	Use this screen to configure LAN TCP/IP settings, and other advanced properties.
	Static DHCP	Use this screen to assign specific IP addresses to individual MAC addresses.
	UPnP	Use this screen to enable the UPnP function.
	File Sharing	Use this screen to enable file sharing via the ZyXEL Device.
	Media Server	Use this screen to enable or disable the sharing of media files.
	Printer Server	Use this screen to enable or disable sharing of a USB printer via your ZyXEL Device.
Routing	Static Route	Use this screen to view and set up static routes on the ZyXEL Device.
DNS Route	DNS Route	Use this screen to view and configure DNS routes.
QoS	General	Use this screen to enable QoS and decide allowable bandwidth using QoS.
	Queue Setup	Use this screen to configure QoS queue assignment.
	Class Setup	Use this screen to set up classifiers to sort traffic into different flows and assign priority and define actions to be performed for a classified traffic flow.
	Monitor	Use this screen to view each queue's statistics.
NAT	Port Forwarding	Use this screen to make your local servers visible to the outside world.
	Sessions	Use this screen to limit the number of NAT sessions a single client can establish.
DNS	Dynamic DNS	Use this screen to allow a static hostname alias for a dynamic IP address.
Security		
Firewall	General	Use this screen to activate/deactivate the firewall.
	Services	Use this screen to set the default action to take on network traffic going in specific directions.
MAC Filter	MAC Filter	Use this screen to allow specific devices to access the ZyXEL Device.
Certificates	Local Certificates	Use this screen to generate and export self-signed certificates or certification requests and import the ZyXEL Device's CA-signed certificates.
	Trusted CAs	Use this screen to save CA certificates to the ZyXEL Device.
VoIP		

Table 2 Navigation Panel Summary (continued)

LINK	TAB	FUNCTION
SIP	SIP Service Provider	Use this screen to configure your ZyXEL Device's Voice over IP settings.
	SIP Account	Use this screen to set up information about your SIP account and configure audio settings such as volume levels for the phones connected to the ZyXEL Device.
	Common	Use this screen to configure RFC3262 support on the ZyXEL Device.
Phone	Phone Device	Use this screen to set which phone ports use which SIP accounts.
	Region	Use this screen to select your location.
Call Rule	Speed Dial	Use this screen to configure speed dial for SIP phone numbers that you call often.
System Monitor		
Log	Phone Log	Use this screen to view the ZyXEL Device's phone logs.
	VoIP Call History	Use this screen to view the ZyXEL Device's VoIP call history.
Traffic Status	WAN	Use this screen to view the status of all network traffic going through the WAN port of the ZyXEL Device.
	LAN	Use this screen to view the status of all network traffic going through the LAN ports of the ZyXEL Device.
	NAT	Use this screen to view the status of NAT sessions on the ZyXEL Device.
	3G Backup	Use this screen to view the status of 3G Backup on the ZyXEL Device.
VoIP Status	VoIP Status	Use this screen to view the SIP, phone, and call status of the ZyXEL Device.
Maintenance		
Users Account	Users Account	Use this screen to configure the passwords your user accounts.
Remote MGMT	Remote MGMT	Use this screen to enable specific traffic directions for network services.
System	System	Use this screen to configure the ZyXEL Device's name, domain name, management inactivity time-out.
Time Setting	Time Setting	Use this screen to change your ZyXEL Device's time and date.
Log Setting	Log Setting	Use this screen to select which logs and/or immediate alerts your device is to record. You can also set it to e-mail the logs to you.
Firmware Upgrade	Firmware Upgrade	Use this screen to upload firmware to your device.
Backup/Restore	Backup/Restore	Use this screen to backup and restore your device's configuration (settings) or reset the factory default settings.

Table 2 Navigation Panel Summary (continued)

LINK	TAB	FUNCTION
Reboot	Reboot	Use this screen to reboot the ZyXEL Device without turning the power off.
Diagnostic	Ping	Use this screen to test the connections to other devices.
	DSL Line	Use this screen to identify problems with the DSL connection.

Tutorials

3.1 Overview

This chapter contains the following tutorials:

- [Setting Up Your DSL Connection](#)
- [How to Set up a Wireless Network](#)
- [Setting Up NAT Port Forwarding](#)
- [How to Make a VoIP Call](#)
- [Using the File Sharing Feature](#)
- [Using the Media Server Feature](#)
- [Using the Print Server Feature](#)
- [Configuring the MAC Address Filter](#)
- [Configuring Static Route for Routing to Another Network](#)
- [Configuring QoS Queue and Class Setup](#)
- [Access the ZyXEL Device Using DDNS](#)

3.2 Setting Up Your DSL Connection

This tutorial shows you how to set up your Internet connection using the web configurator.

If you connect to the Internet through a DSL connection, use the information from your Internet Service Provider (ISP) to configure the ZyXEL Device. Do the following steps:

- 1 Connect the ZyXEL Device properly. Refer to the Quick Start Guide for details on the ZyXEL Device's hardware connection.
- 2 Check the back panel of your device where the Ethernet ports are located and make sure the **DSL/WAN** switch is pointing up to **DSL**.

- 3 Connect one end of a DSL cable to the DSL port of your ZyXEL Device. The other end should be connected to the DSL port in your house or a DSL router/modem provided by your ISP.
- 4 Connect one end of Ethernet cable to an Ethernet port on the ZyXEL Device and the other end to a computer that you will use to access the web configurator.
- 5 Connect the ZyXEL Device to a power source, turn it on and wait for the **POWER** LED to become a steady green. Turn on the modem provided by your ISP as well as the computer.

Account Configuration

- 1 Click **Network Setting > Broadband** to open the following screen. Click **Add new WAN Interface**.

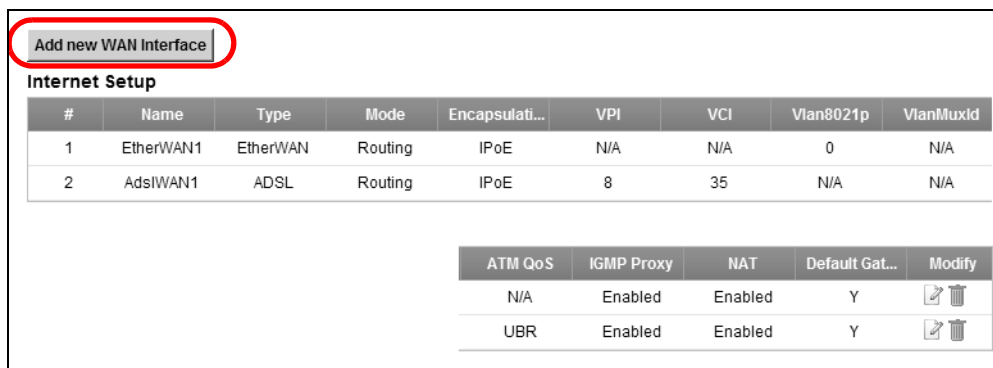

- 2 For this example, the interface type is ADSL and the connection has the following information.

General	
Name	MyDSLConnection
Type	ADSL
Mode	Routing
WAN Service Type	PPPoE
ATM PVC Configuration	
VPI/VCI	36/48
Encapsulation Mode	LLC/SNAP-Bridging
Service Category	UBR without PCR
PPP Information	
PPP User Name	1234@DSL-Ex.com
PPP Password	ABCDEF!

PPPoE Service Name	My DSL
Authentication Method	Auto
Static IP Address	192.168.1.32
Others	PPPoE Passthrough: Disabled NAT: Enabled IGMP Multicast Proxy: Enabled Apply as Default Gateway: Enable DNS Server: Static DNS IP Address (Primary: 192.168.1.254 Secondary: 192.168.1.253)

Enter or select these values and click **Apply**.

General

Name :

Type :

Mode :

WANServiceType :

ATM PVC Configuration

VPI[0-255]:

VCI[32-65535]:

DSL Link Type :

Encapsulation Mode :

Service Category :

PPP Information

PPPOEUserName :

PPPOEPassword :

PPPOEServiceName :

Authentication Method :

Use Static IP Address

IP Address :

PPPoE Passthrough

Routing Feature

NAT Enable :

IGMP Proxy Enable :

Apply as Default Gateway :

DNS Server

Obtain DNS info Automatically







Use the following Static DNS IP Address

Primary DNS Server :

Secondary DNS Server :

This completes your DSL WAN connection setting.

- 3 You should see a summary of your new DSL connection setup in the **Broadband** screen as follows.

Add new WAN Interface													
Internet Setup													
#	Name	Type	Mode	Encapsu...	VPI	VCI	Vlan802...	VlanMux...	ATM QoS	IGMP Pr...	NAT	Default ...	Modify
1	EtherWA..	EtherWAN	Routing	IPoE	N/A	N/A	0	N/A	N/A	Enabled	Enabled	Y	 
2	AdslWAN1	ADSL	Routing	IPoE	8	35	N/A	N/A	UBR	Disabled	Enabled	N	 
3	MyDSL...	ADSL	Routing	PPPoE	36	48	N/A	N/A	UBR	Enabled	Enabled	Y	 

Try to connect to a website, such as “www. zyxel.com” to see if you have correctly set up your Internet connection. Be sure to contact your service provider for any information you need to configure the WAN screens.

3.3 How to Set up a Wireless Network

This section gives you examples of how to set up an access point and wireless client for wireless communication using the following parameters. The wireless clients can access the Internet through the ZyXEL Device wirelessly.

3.3.1 Example Parameters

SSID	SSID_Example3
802.11 mode	802.11b/g
Channel	auto
Security	WPA-PSK (Pre-Shared Key: ThisismyWPA-PSKpre-sharedkey)

An access point (AP) or wireless router is referred to as the “AP” and a computer with a wireless network card or USB adapter is referred to as the “wireless client” here.

We use the P-2612HNU-Fx web screens and M-302 utility screens as an example. The screens may vary slightly for different models.

3.3.2 Configuring the AP

Follow the steps below to configure the wireless settings on your AP.

- 1 Open the **Network Setting > Wireless > General** screen in the AP's web configurator.

The screenshot shows the 'Wireless Network Setup' web configurator interface. It is divided into several sections:

- Wireless :** A checkbox labeled 'Enable Wireless LAN' is checked.
- Wireless Network Settings :**
 - Wireless Network Name(SSID):** A text input field contains 'SSID_Example3'.
 - Hide SSID:** A checkbox is unchecked.
 - BSSID :** A text input field contains '40:4a:03:ff:5b:e4'.
 - Mode Select :** A dropdown menu is set to '802.11b/g'.
 - Channel Selection :** A dropdown menu is set to 'Auto', with a 'Scan' button next to it.
 - Operating Channel :** A text input field contains '6'.
- Security Level :** A horizontal slider is positioned over three levels: 'No Security', 'Basic', and 'More Secure (Recommended)'. The slider is moved to the 'More Secure' level. Below the slider is a pop-up window for security settings:
 - Security Mode :** A dropdown menu is set to 'WPA-PSK'.
 - Pre-Shared Key :** A text input field contains 'WPA-PSKpre-sharedkey', with a 'hide more' link to its right.
 - Encryption :** A dropdown menu is set to 'TKIP'.



At the bottom right of the interface are 'Apply' and 'Cancel' buttons.

- 2 Make sure **Enable Wireless LAN** is selected.
- 3 Enter "SSID_Example3" as the SSID and select **Auto** in the **Channel Selection** field to have the device search for an available channel.
- 4 Select **802.11b/g** in the **Mode Select** field.
- 5 Select **More Secure** as your security level and set security mode to **WPA-PSK** and enter "ThisismyWPA-PSKpre-sharedkey" in the **Pre-Shared Key** field. Click **Apply**.

- 6 Click **Connection Status > System Info**. Verify your wireless and wireless security settings under **Device Information** and check if the WLAN connection is up under **Interface Status**.

Device Information	
Host Name:	P-2612HNU-F1
Model Name:	P-2612HNU-F1 ;
MAC Address:	40.4a:03:ff:5b:e3
Firmware Version:	V3.10(BLT.0)b2
WAN 1 Information:	(ADSL WAN 1)
- Mode:	EoA
- IP Address:	
- IP Subnet Mask:	
WAN 2 Information:	(ADSL WAN 2)
- Mode:	EoA
- IP Address:	
LAN Information:	
IP Address:	192.168.1.1
- IP Subnet Mask:	255.255.255.0
- DHCP Server:	Server
WLAN Information:	
- Channel:	1
- WPS Status:	Configured
SSID1 Information:	
- SSID:	SSID_Example3
- Status:	On
- Security Mode:	WPA-PSK
SSID2 Information:	
- SSID:	ZyXEL2

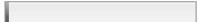
Interface Status		
Interface	Status	Rate
ADSL WAN	Down	N/A
LAN 1	Up	1000Mbps
LAN 2	Down	N/A
LAN 3	Down	N/A
LAN 4	Down	N/A
WLAN	Up	54Mbps
3G	Disabled	N/A

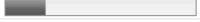
System Status	
System Up Time:	1:26
Current Date/Time:	Sat Jan 1 01:26:42 UTC 2000
System Resource:	
- CPU Usage:	 0.0%
- Memory Usage:	 71.1%
- Power Usage:	 6.1W (+-1W)
	4W 14W

This finishes the configuration of the AP.

3.3.3 Configuring the Wireless Client

This section describes how to connect the wireless client to a network.

3.3.3.1 Connecting to a Wireless LAN

The following sections show you how to join a wireless network using the ZyXEL utility, as in the following diagram. The wireless client is labeled **C** and the access point is labeled **AP**.

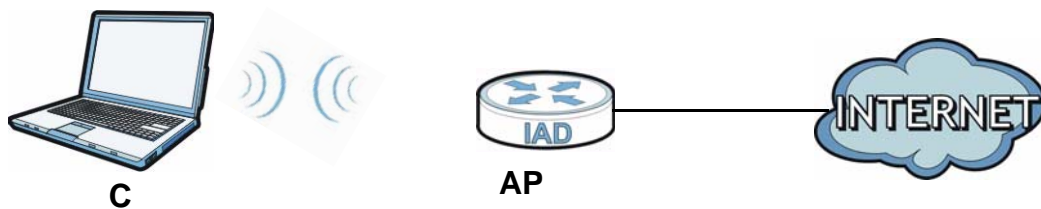

There are three ways to connect the client to an access point.

- Configure nothing and leave the wireless client to automatically scan for and connect to any available network that has no wireless security configured.
- Manually connect to a network.
- Configure a profile to have the wireless client automatically connect to a specific network or peer computer.

This example illustrates how to manually connect your wireless client to an access point (AP) which is configured for WPA-PSK security and connected to the Internet. Before you connect to the access point, you must know its Service Set IDentity (SSID) and WPA-PSK pre-shared key. In this example, the SSID is "SSID_Example3" and the pre-shared key is "ThisismyWPA-PSKpre-sharedkey".

After you install the ZyXEL utility and then insert the wireless client, follow the steps below to connect to a network using the **Site Survey** screen.

- 1 Open the ZyXEL utility and click the **Site Survey** tab to open the screen shown next.

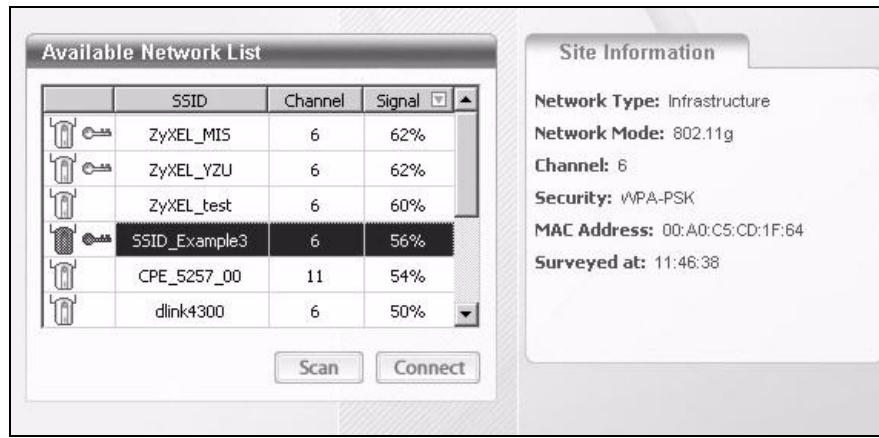

- 2 The wireless client automatically searches for available wireless networks. Click **Scan** if you want to search again. If no entry displays in the **Available Network List**, that means there is no wireless network available within range. Make sure the AP or peer computer is turned on or move the wireless client closer to the AP or peer computer.

- 3 When you try to connect to an AP with security configured, a window will pop up prompting you to specify the security settings. Enter the pre-shared key and leave the encryption type at the default setting.

Use the **Next** button to move on to the next screen. You can use the **Back** button at any time to return to the previous screen, or the **Exit** button to return to the **Site Survey** screen.

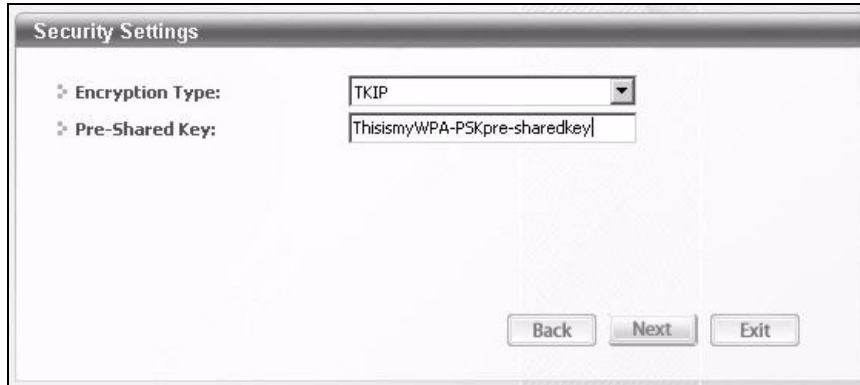

- 4 The **Confirm Save** window appears. Check your settings and click **Save** to continue.

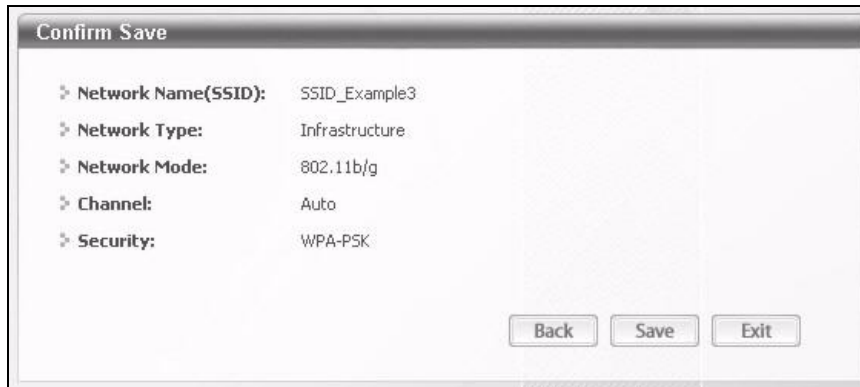

- 5 The ZyXEL utility returns to the **Link Info** screen while it connects to the wireless network using your settings. When the wireless link is established, the ZyXEL utility icon in the system tray turns green and the **Link Info** screen displays details of the active connection. Check the network information in the **Link Info** screen to verify that you have successfully connected to the selected network. If the wireless client is not connected to a network, the fields in this screen remain blank.

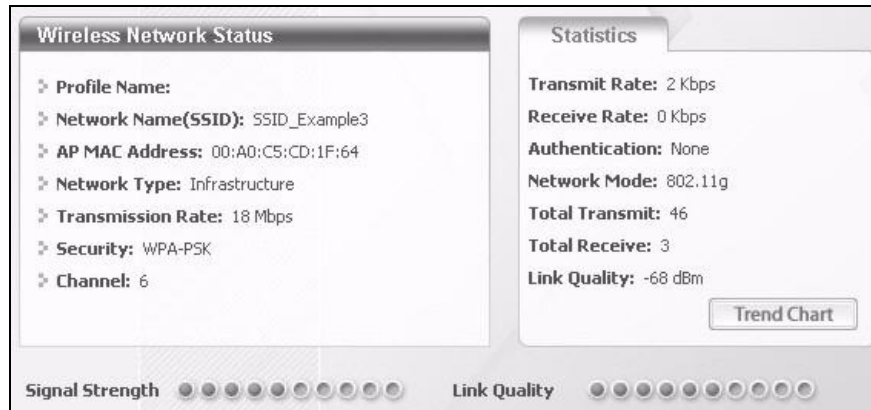

- 6 Open your Internet browser and enter <http://www.zyxel.com> or the URL of any other web site in the address bar. If you are able to access the web site, your wireless connection is successfully configured.

If you cannot access the web site, try changing the encryption type in the **Security Settings** screen, check the Troubleshooting section of this User's Guide or contact your network administrator.

3.3.3.2 Creating and Using a Profile

A profile lets you easily connect to the same wireless network again later. You can also configure different profiles for different networks, for example if you connect a notebook computer to wireless networks at home and at work.

This example illustrates how to set up a profile and connect the wireless client to an AP configured for WPA-PSK security. In this example, the SSID is "SSID_Example3", the profile name is "PN_Example3" and the pre-shared key is "ThisismyWPA-PSKpre-sharedkey". You have chosen the profile name "PN_Example3".

- 1 Open the ZyXEL utility and click the **Profile** tab to open the screen shown next. Click **Add** to configure a new profile.

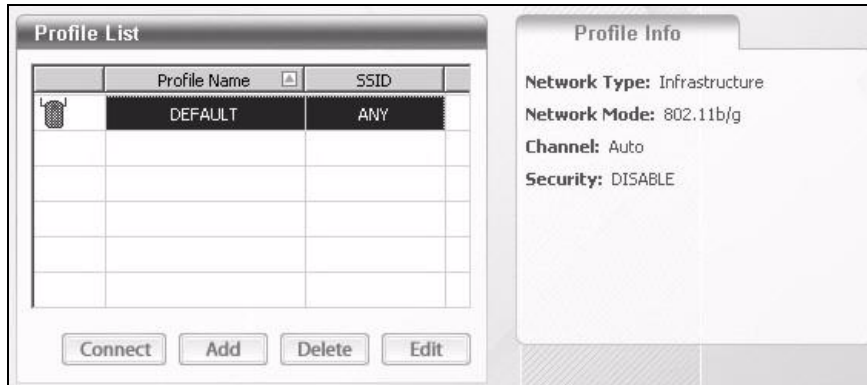

- 2 The **Add New Profile** screen appears. The wireless client automatically searches for available wireless networks, and displays them in the **Scan Info** box. Click **Scan** if you want to search again. You can also configure your profile for a wireless network that is not in the list.

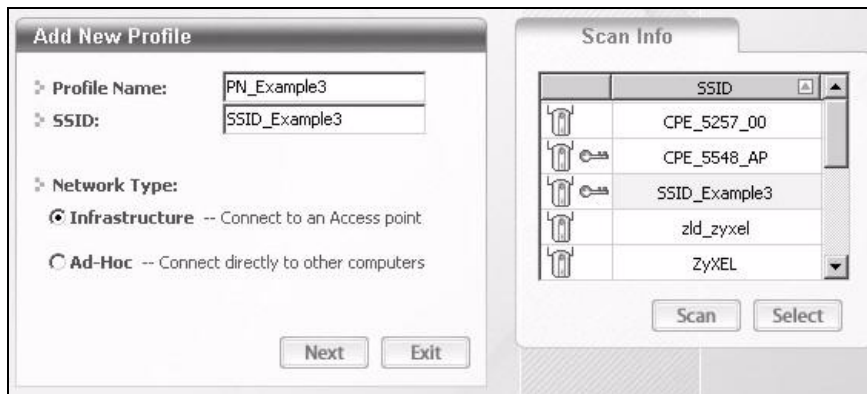

- 3 Give the profile a descriptive name (of up to 32 printable ASCII characters). Select **Infrastructure** and either manually enter or select the AP's SSID in the **Scan Info** table and click **Select**.

- 4 Choose the same encryption method as the AP to which you want to connect (In this example, WPA-PSK).

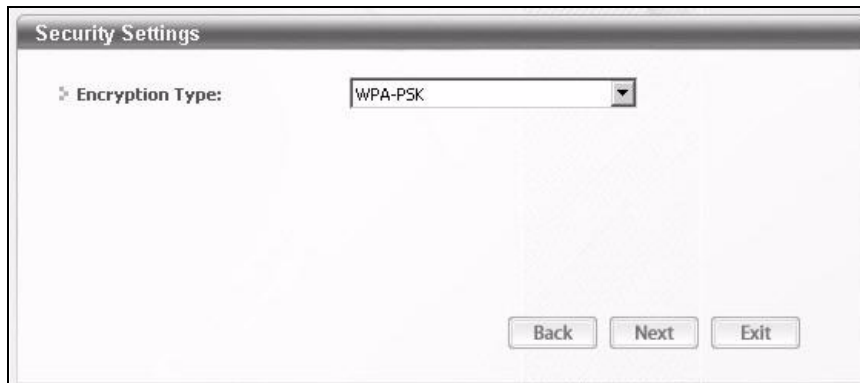

The image shows a 'Security Settings' dialog box. It has a title bar with the text 'Security Settings'. Below the title bar, there is a label 'Encryption Type:' followed by a dropdown menu. The dropdown menu is currently set to 'WPA-PSK'. At the bottom of the dialog box, there are three buttons: 'Back', 'Next', and 'Exit'.

- 5 This screen varies depending on the encryption method you selected in the previous screen. Enter the pre-shared key and leave the encryption type at the default setting.

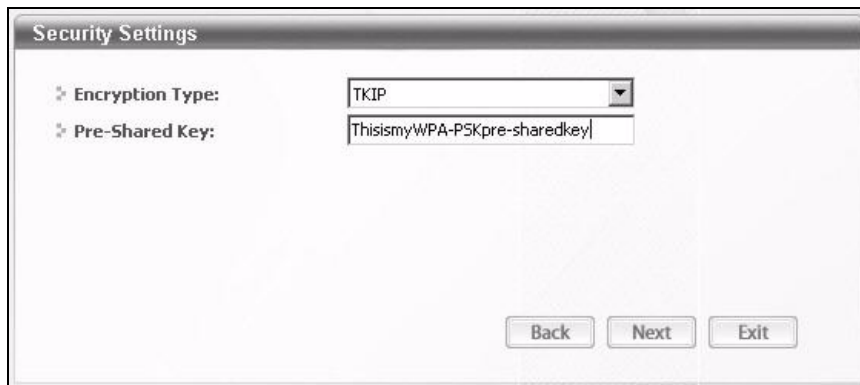

The image shows a 'Security Settings' dialog box. It has a title bar with the text 'Security Settings'. Below the title bar, there are two labels: 'Encryption Type:' and 'Pre-Shared Key:'. The 'Encryption Type:' dropdown menu is set to 'TKIP'. The 'Pre-Shared Key:' text box contains the text 'ThisismyWPA-PSKpre-sharedkey'. At the bottom of the dialog box, there are three buttons: 'Back', 'Next', and 'Exit'.

- 6 In the next screen, leave both boxes selected.

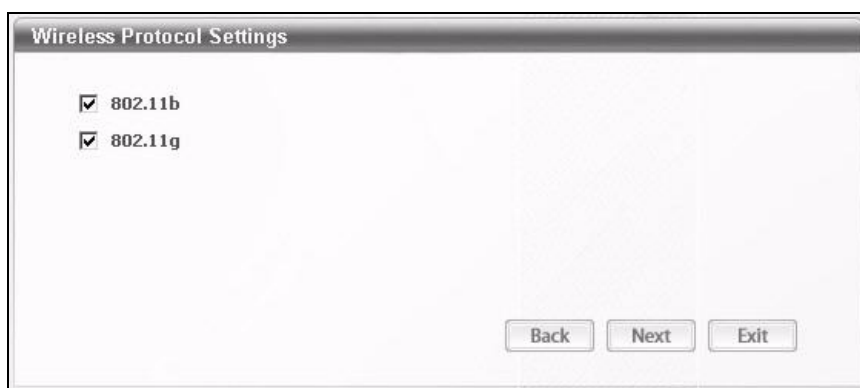

The image shows a 'Wireless Protocol Settings' dialog box. It has a title bar with the text 'Wireless Protocol Settings'. Below the title bar, there are two checkboxes: '802.11b' and '802.11g'. Both checkboxes are checked. At the bottom of the dialog box, there are three buttons: 'Back', 'Next', and 'Exit'.

- 7 Verify the profile settings in the read-only screen. Click **Save** to save and go to the next screen.

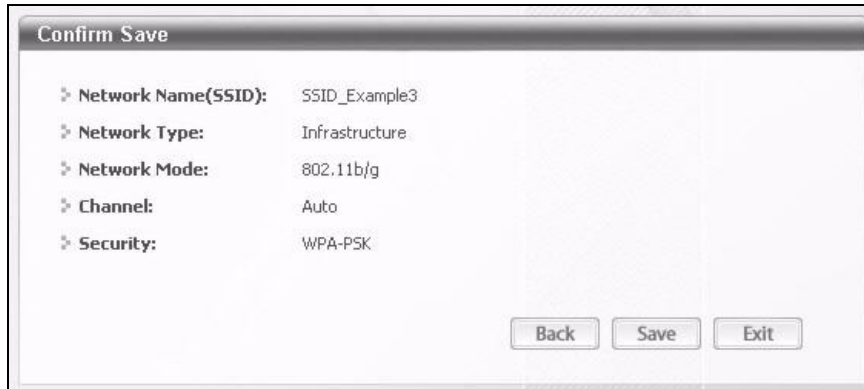

- 8 Click **Activate Now** to use the new profile immediately. Otherwise, click the **Activate Later** button.

If you clicked **Activate Later**, you can select the profile from the list in the **Profile** screen and click **Connect** to activate it.

Note: Only one profile can be activated and used at any given time.



- 9 When you activate the new profile, the ZyXEL utility returns to the **Link Info** screen while it connects to the AP using your settings. When the wireless link is established, the ZyXEL utility icon in the system tray turns green and the **Link Info** screen displays details of the active connection.
- 10 Open your Internet browser, enter <http://www.zyxel.com> or the URL of any other web site in the address bar and press ENTER. If you are able to access the web site, your new profile is successfully configured.
- 11 If you cannot access the Internet go back to the **Profile** screen, select the profile you are using and click **Edit**. Check the details you entered previously. Also, refer to the Troubleshooting section of this User's Guide or contact your network administrator if necessary.

3.4 Setting Up NAT Port Forwarding

In this tutorial, you manage the Doom server on a computer behind the ZyXEL Device. In order for players on the Internet (like **A** in the figure below) to communicate with the Doom server, you need to configure the port settings and IP address on the ZyXEL Device. Traffic should be forwarded to the port 666 of the Doom server computer which has an IP address of 192.168.1.34.

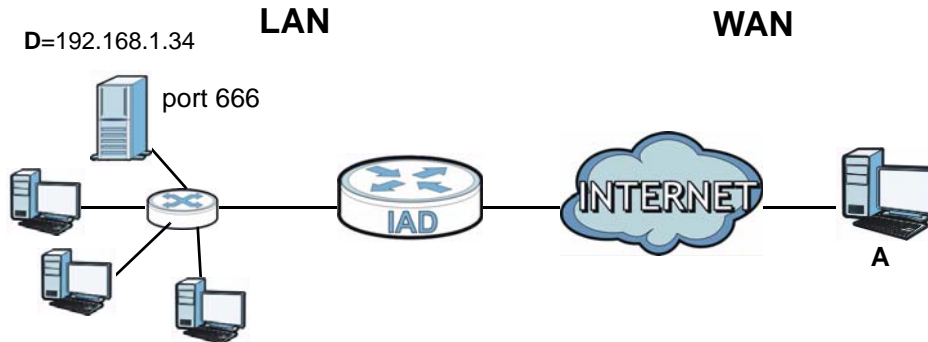

You may set up the port settings by configuring the port settings for the Doom server computer (see [Chapter 11 on page 204](#) for more information).

- 1 Click **Network Setting** > **NAT** > **Port Forwarding**. Click **Add new rule**.

- 2 Enter the following values:

Service Name	Select User Defined .
WAN Interface	Select the WAN interface through which the Doom service is forwarded. This is the default interface for this example, which is MyDSLConnection .
Start/End Ports	666
Translation Start/End Ports	666
Server IP Address	Enter the IP address of the Doom server. This is 192.168.1.34 for this example.
Protocol	Select TCP/UDP . This should be the protocol supported by the Doom server.

- 3 Click **Apply**.
- 4 The port forwarding settings you configured should appear in the table. Make sure the **Status** check box for this rule is selected. Click **Apply** to have the ZyXEL Device start forwarding port 666 traffic to the computer with IP address 192.168.1.34.

Add new rule										
#	Status	ServiceName	WAN Interface	Start Port	End Port	Translation Start Port	Translation End Port	Server IP Address	Protocol	Modify
1	<input checked="" type="checkbox"/>	User Defined	MyDSLConne	666	666	666	666	192.168.1.34	TCP/UDP	

Apply Cancel

Players on the Internet then can have access to your Doom server.

3.5 How to Make a VoIP Call

You can register a SIP account with the SIP server and make voice calls over the Internet to another VoIP device.

The following parameters are used in this example:

SIP Service Provider Name	ServiceProvider1
SIP Account Number	12345678
Username	ChangeMe
Password	ThisIsMySIP

3.5.1 VoIP Calls With a Registered SIP Account

To use a registered SIP account, you should configure the SIP service provider and applied for a SIP account.

3.5.1.1 SIP Service Provider Configuration

Follow the steps below to configure your SIP service provider.

- 1 Make sure your ZyXEL Device is connected to the Internet.
- 2 Open the web configurator.
- 3 Click **VoIP > SIP** to open the **SIP Service Provider** screen. Select **Add New** from the **Service Provider Selection** drop-down list box.

- 4 Select the **Enable** check box of **SIP Service Provider** and enter the **SIP Service Provider Name**.

SIP Service Provider Selection

Service Provider Selection : -- Add New -- Delete

General

SIP Service Provider : Enable SIP Service Provider

SIP Service Provider Name :

SIP Local Port : (1025-65535)

SIP Server Address :

SIP Server Port : (1025-65535)

REGISTER Server Address :

REGISTER Server Port : (1025-65535)

SIP Service Domain :

[more...](#)

Apply Cancel

- 5 Go to the **SIP Account** screen, click the **Edit** icon of **SIP 3**.

Add new SIP account					
#	Active	SIP Account	SIP Service Provider	Account No.	Modify
1	💡	SIP 1	ChangeMe	ChangeMe	✎ 🗑
2	💡	SIP 2	ChangeMe	ChangeMe	✎ 🗑
3	💡	SIP 3	ServiceProvider1	ChangeMe	✎ 🗑 ✎ 🗑

- 6 Select the **Active SIP Account** check box, then enter the **SIP Account Number**, **Username**, and **Password**. Leave other settings as default.

- Click **Apply** to save your settings.

SIP Service Provider Selection
Service Provider Selection :

SIP Account Selection
SIP Account Selection :

General
SIP Account : Active SIP Account
SIP Account Number :

Authenticaton
Username :
Password :

3.5.1.2 SIP Account Registration

Follow the steps below to register and activate your SIP account.

- Click **Connection Status > System Info** to check if your SIP account has been registered successfully. If the status is **Not Registered**, check your Internet connection and click **Register** to register your SIP account.

Account	Action	Account Status	URI
SIP 1	<input type="button" value="Register"/>	In-Active	ChangeMe@ChangeMe
SIP 2	<input type="button" value="Register"/>	In-Active	ChangeMe@ChangeMe
SIP 3	<input type="button" value="Register"/>	Not Registered	12345678@ChangeMe

3.5.1.3 Analog Phone Configuration

- Click **VoIP > Phone** to open the **Phone Device** screen. Click the **Edit** icon next to **Analog Phone 1** to configure the first phone port.

#	Phone ID	Outgoing SIP Number	Modify
1	Analog Phone 1	ChangeMe	<input type="button" value="Edit"/>
2	Analog Phone 2	ChangeMe	<input type="button" value="Edit"/>

- Select **SIP 3** from the **SIP Account** in the **SIP Account to Make Outgoing Call** section to have the phone (connected to the first phone port) use the registered SIP 3 account to make outgoing calls.

- 3 Select the **SIP 3** check box in the **SIP Account(s) to Receive Incoming Call** section to have the phone (connected to the first phone port) receive phone calls for the SIP 3 account.
- 4 Click **Apply** to save your changes.

SIP Account to Make Outgoing Call			
SIP Account	SIP Number	SIP Account	SIP Number
<input type="radio"/> SIP 1	ChangeMe	<input type="radio"/> SIP 2	ChangeMe
<input checked="" type="radio"/> SIP 3	12345678	<input type="radio"/>	

SIP Account(s) to Receive Incoming Call			
SIP Account	SIP Number	SIP Account	SIP Number
<input checked="" type="checkbox"/> SIP 1	ChangeMe	<input type="checkbox"/> SIP 2	ChangeMe
<input checked="" type="checkbox"/> SIP 3	12345678	<input type="checkbox"/>	

3.5.1.4 Making a VoIP Call

- 1 Make sure you connect a telephone to the first phone port on the ZyXEL Device.
- 2 Make sure the ZyXEL Device is on and connected to the Internet.
- 3 Pick up the phone receiver.
- 4 Dial the VoIP phone number you want to call.

3.6 Using the File Sharing Feature

In this section you can:

- Set up file sharing of your USB device from the ZyXEL Device
- Access the shared files of your USB device from a computer

3.6.1 Set Up File Sharing

To set up file sharing you need to connect your USB device, enable file sharing and set up your share(s).

3.6.1.1 Activate File Sharing

- 1 Connect your USB device to one of the USB ports at the back panel of the ZyXEL Device.
- 2 Click **Network Setting > Home Networking > File Sharing**. Select **Enable** and click **Apply** to activate the file sharing function. The ZyXEL Device automatically adds your USB device to the **Share Directory List**.

Server Configuration

File Sharing Services(SMB): Enable Disable

Share Directory List

Add new share

#	Status	Share Name	Share Path	Share Description	Modify
1	<input checked="" type="checkbox"/>	USB_Storage	GENERIC_USB_Mass_Storage_100_1	USB_Storage	

Apply Cancel

3.6.1.2 Set up File Sharing on Your ZyXEL Device

You also need to set up file sharing on your ZyXEL Device in order to share files.

- 1 Click **Add new share** in the **File Sharing** screen to configure a new share. Select your USB device from the **Volume** drop-down list box.
- 2 Click **Browse** to browse through all the files on your USB device. Select the folder that you want to add as a share. In this example, select **Bob's_Share**. Click **Apply**.

● GENERIC_USB_Mass_Storage_100_1

Select	Type	Name	Date
<input type="radio"/>		.	N/A
<input checked="" type="radio"/>		Bob's_Share	2010-08-25 09:45:26
<input type="radio"/>		Mac	2010-08-17 09:38:36
<input type="radio"/>		zywall-1050_dir	2003-01-01 06:08:00
<input type="radio"/>		Win 7	2010-04-27 14:51:36
<input type="radio"/>		NWD-2205_(PowerPC)MacOS10.4_Driver_1003_UI_1.7.9	2010-08-17 15:15:16
<input type="radio"/>		RECYCLER	2010-08-22

Apply Back

- 3 You can add a description for the share or leave it blank. The **Add Share Directory** screen should look like the following. Click **Apply** to finish.

- 4 This sets up the file sharing server. You can see the USB storage device listed in the table below.

Share Directory List						
#	Status	Share Name	Share Path	Share Description	Modify	
✓		GENERIC_USB_Mass_Storage...	GENERIC_USB_Mass_Storage_100_1	GENERIC_USB_Mass_Storage_100_1		
✓		USB_Storage	GENERIC_USB_Mass_Storage_100_1	USB_Storage		

Apply Cancel

3.6.2 Access Your Shared Files From a Computer

You can use Windows Explorer to access the file storage devices connected to the ZyXEL Device.

Note: The examples in this User's Guide show you how to use Microsoft's Windows XP to browse your shared files. Refer to your operating system's documentation for how to browse your file structure.

Open Windows Explorer to access Bob's Share using Windows Explorer browser.

In Windows Explorer's Address bar type a double backslash "\\ " followed by the IP address of the ZyXEL Device (the default IP address of the ZyXEL Device is 192.168.1.1) and press [ENTER]. The share folder **Bob's_Share** is available.

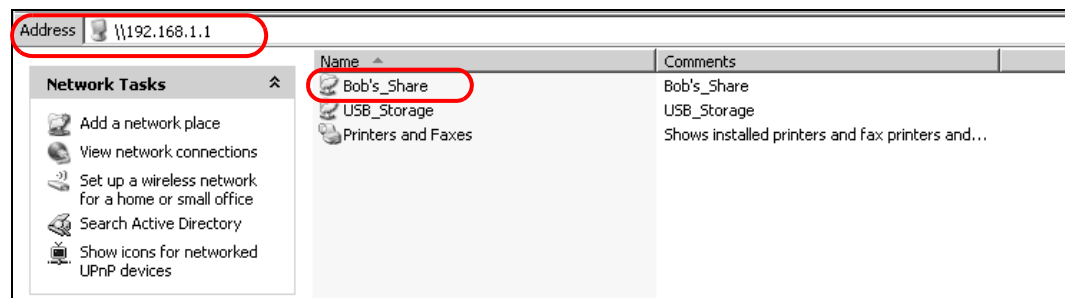

Once you access **Bob's_Share** via your ZyXEL Device, you do not have to relogin unless you restart your computer.

3.7 Using the Media Server Feature

Use the media server feature to play files on a computer or on your television (using DMA-2500).

This section shows you how the media server feature works using the following media clients:

- Microsoft (MS) Windows Media Player

Media Server works with Windows Vista and Windows 7. Make sure your computer is able to play media files (music, videos and pictures).

- ZyXEL DMA-2500, a digital media adapter

You need to set up the DMA-2500 to work with your television (TV). Refer to the DMA-2500 Quick Start Guide for the correct hardware connections.

Before you begin, connect the USB storage device containing the media files you want to play to the USB port of your ZyXEL Device.

3.7.1 Configuring the ZyXEL Device

Note: The Media Server feature is enabled by default.

To use your ZyXEL Device as a media server, click **Network Setting > Home Networking > Media Server**.

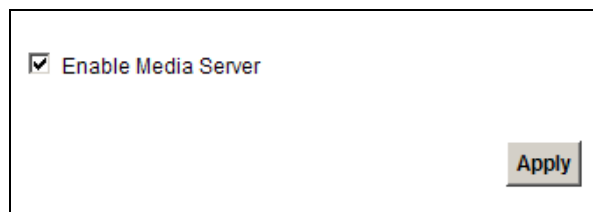

Check **Enable Media Server** and click **Apply**. This enables DLNA-compliant media clients to play the video, music and image files in your USB storage device.

3.7.2 Using Windows Media Player

This section shows you how to play the media files on the USB storage device connected to your ZyXEL Device using Windows Media Player.

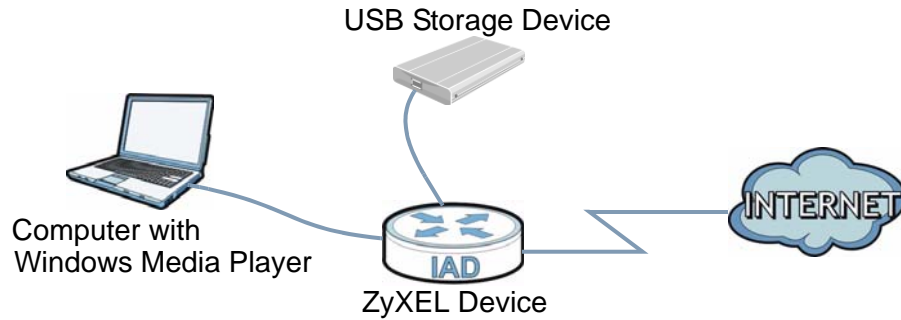

Windows Vista

- 1 Open Windows Media Player and click **Library > Media Sharing** as follows.

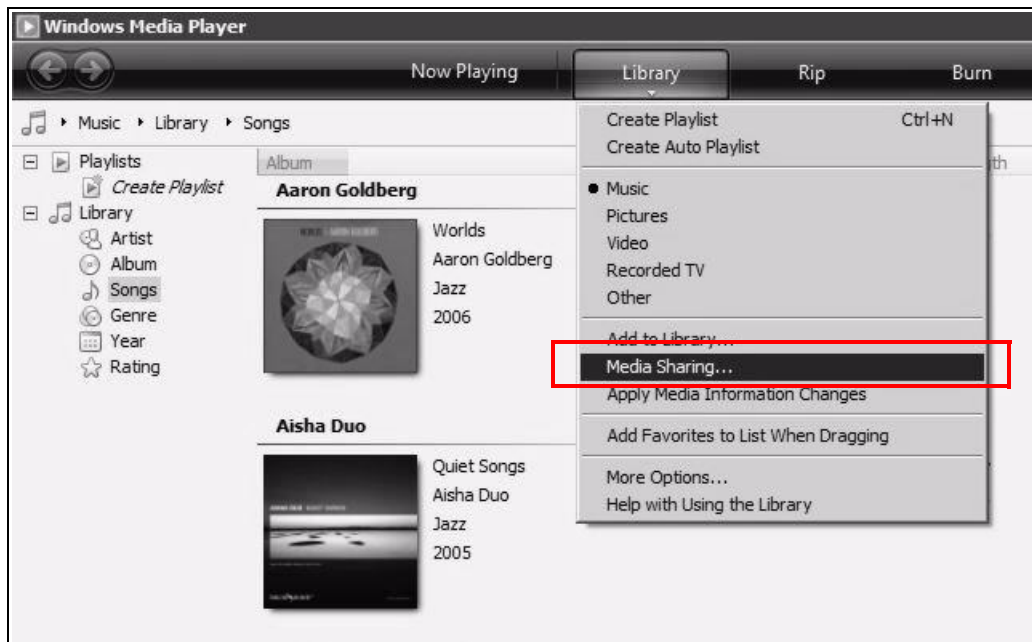

- 2 Check **Find media that others are sharing** in the following screen and click **OK**.

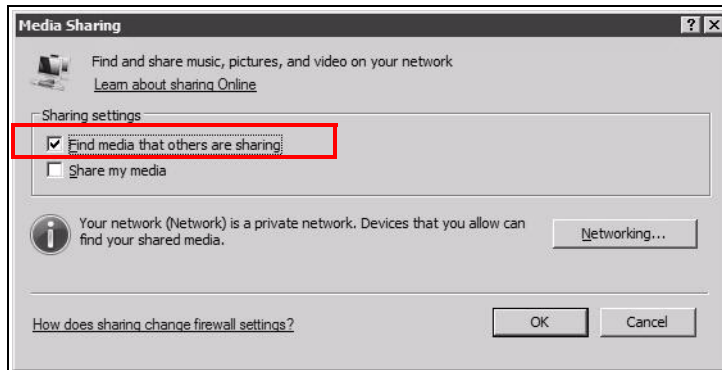

- 3 In the **Library** screen, check the left panel. The Windows Media Player should detect the ZyXEL Device.

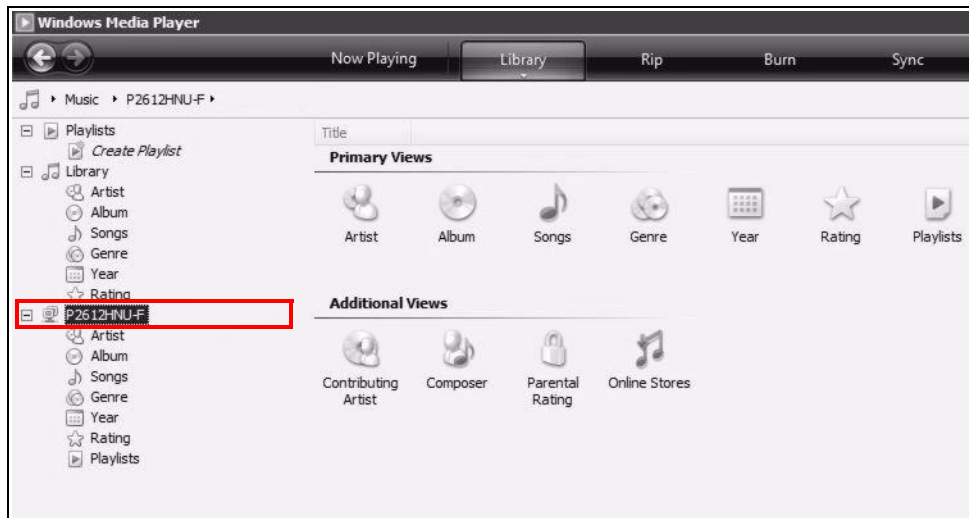

The ZyXEL Device displays as a playlist. Clicking on the category icons in the right panel shows you the media files in the USB storage device attached to your ZyXEL Device.

Windows 7

- 1 Open Windows Media Player. It should automatically detect the ZyXEL Device.

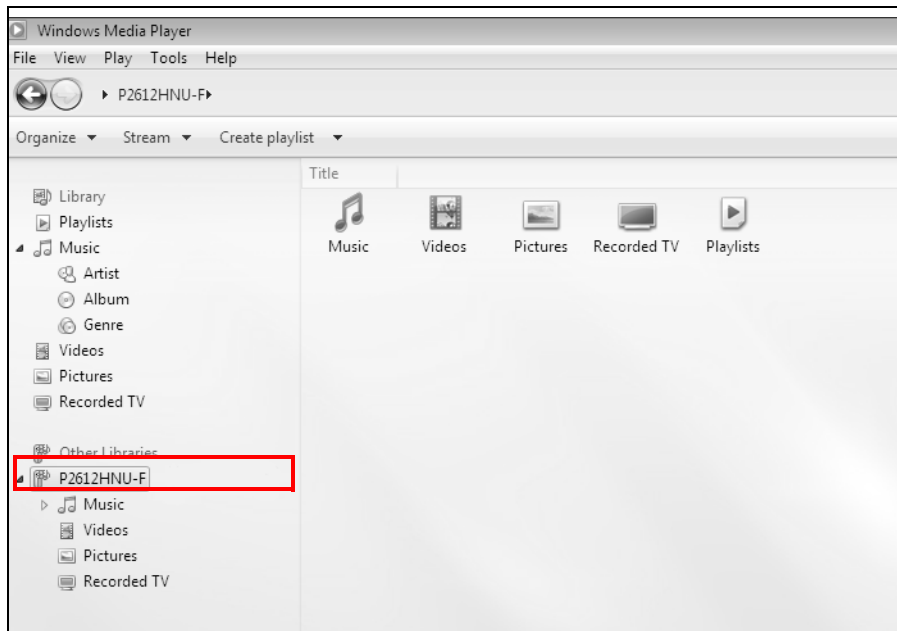

If you cannot see the ZyXEL Device in the left panel as shown above, right-click **Other Libraries > Refresh Other Libraries**.

- 2 Select a category in the left panel and wait for Windows Media Player to connect to the ZyXEL Device.

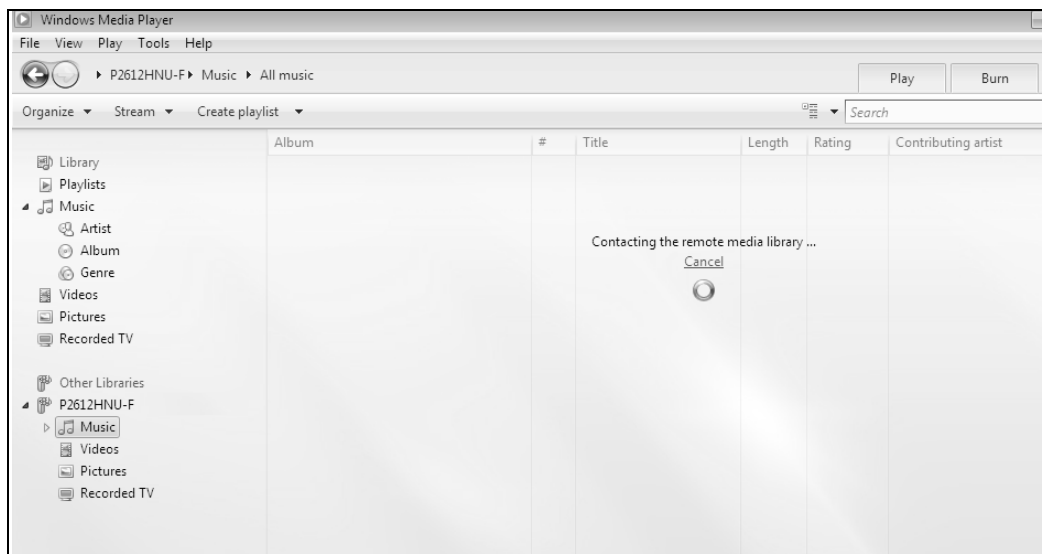

- 3 In the right panel, you should see a list of files available in the USB storage device.

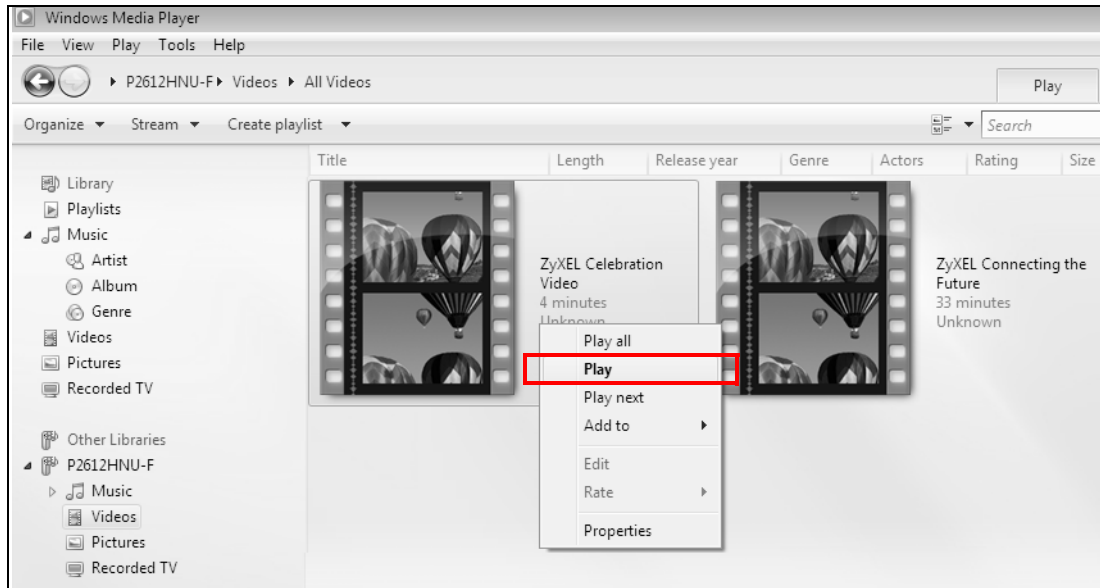

3.7.3 Using a Digital Media Adapter

This section shows you how you can use the ZyXEL Device with a ZyXEL DMA-2500 to play media files stored in the USB storage device in your TV screen.

Note: For this tutorial, your DMA-2500 should already be set up with the TV according to the instructions in the DMA-2500 Quick Start Guide.

- 1 Connect the DMA-2500 to an available LAN port in your ZyXEL Device.

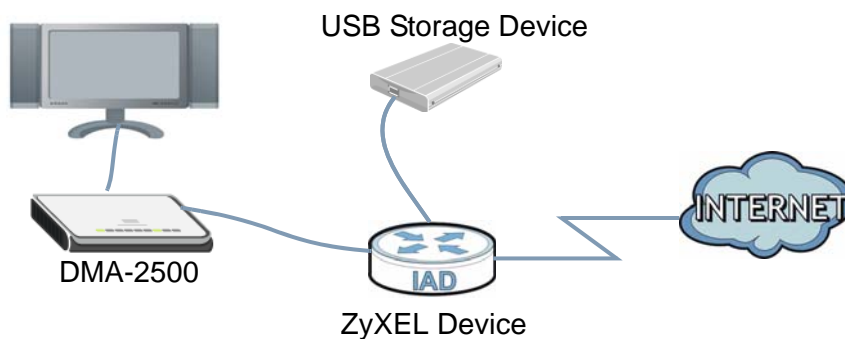

- 2 Turn on the TV and wait for the DMA-2500 **Home** screen to appear. Using the remote control, go to **MyMedia** to open the following screen. Select the ZyXEL Device as your media server.

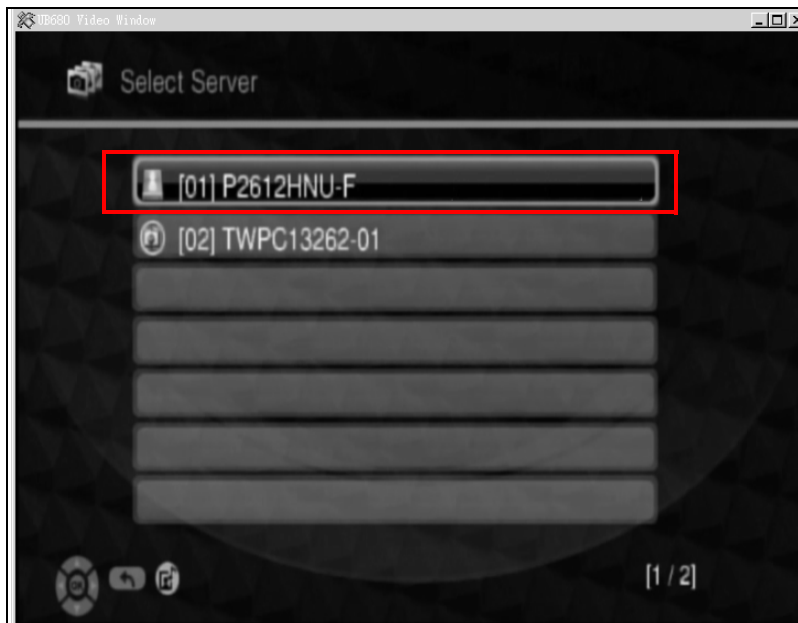

- 3 The screen shows you the list of available media files in the USB storage device. Select the file you want to open and push the **Play** button in the remote control.



3.8 Using the Print Server Feature

In this section you can:

- Configure a TCP/IP Printer Port
- Add a New Printer Using Windows
- Add a New Printer Using Macintosh OS X

Configure a TCP/IP Printer Port

This example shows how you can configure a TCP/IP printer port. This example is done using the Windows 2000 Professional operating system. Some menu items may look different on your operating system. The TCP/IP port must be configured with the IP address of the ZyXEL Device and must use the RAW protocol to communicate with the printer. Consult your operating systems documentation for instructions on how to do this or follow the instructions below if you have a Windows 2000/XP operating system.

- 1 Click **Start > Settings**, then right click on **Printers** and select **Open**.

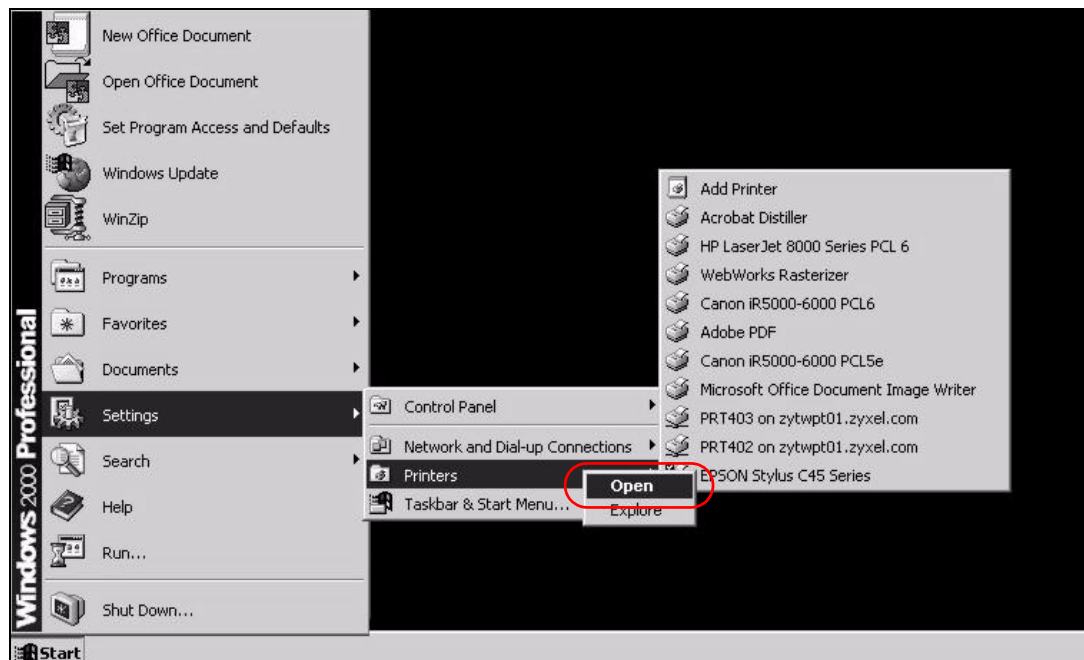

The **Printers** folder opens up. First you need to open up the properties windows for the printer you want to configure a TCP/IP port.

- 2 Locate your printer.

3 Right click on your printer and select **Properties**.

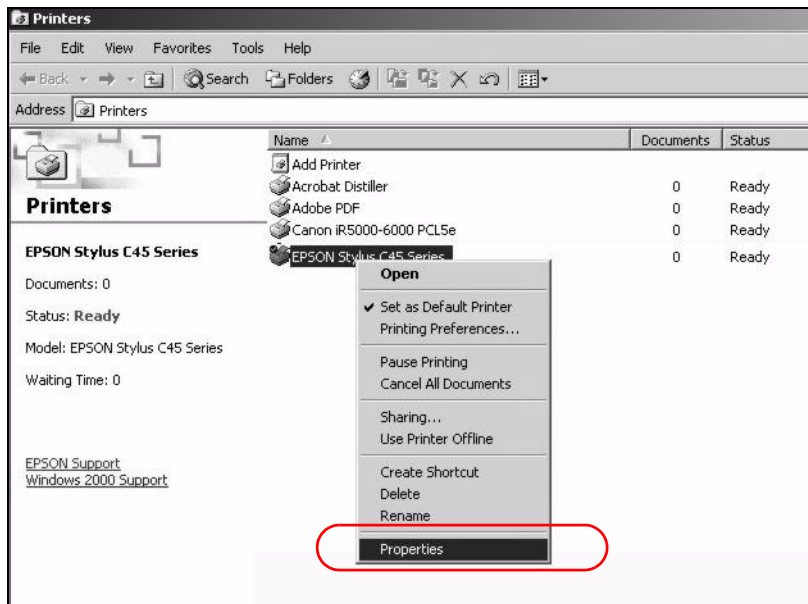

4 Select the **Ports** tab and click **Add Port...**

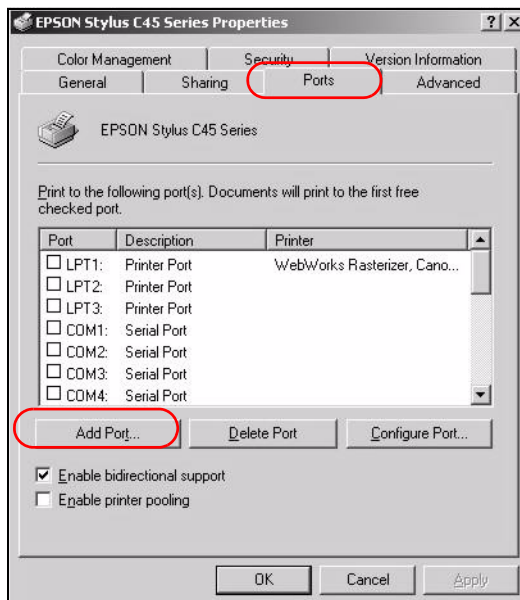

- 5 A **Printer Ports** window appears. Select **Standard TCP/IP Port** and click **New Port...**

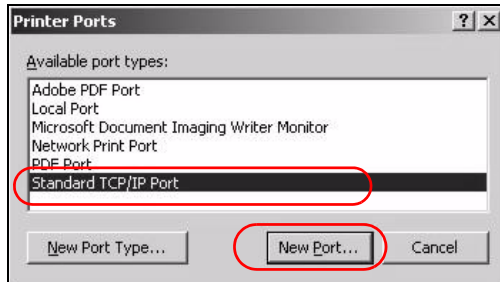

- 6 **Add Standard TCP/IP Printer Port Wizard** window opens up. Click **Next** to start configuring the printer port.



- 7 Enter the IP address of the ZyXEL Device to which the printer is connected in the **Printer Name or IP Address:** field. In our example we use the default IP address of the ZyXEL Device, 192.168.1.1. The **Port Name** field updates automatically to reflect the IP address of the port. Click **Next**.

Note: The computer from which you are configuring the TCP/IP printer port must be on the same LAN in order to use the printer sharing function.

The screenshot shows the 'Add Standard TCP/IP Printer Port Wizard' dialog box. The title bar reads 'Add Standard TCP/IP Printer Port Wizard'. The main heading is 'Add Port' with the instruction 'For which device do you want to add a port?'. Below this, it says 'Enter the Printer Name or IP address, and a port name for the desired device.' There are two text input fields: 'Printer Name or IP Address:' containing '192.168.1.1' and 'Port Name:' containing 'IP_192.168.1.1'. At the bottom, there are three buttons: '< Back', 'Next >', and 'Cancel'.

- 8 Select **Custom** under **Device Type** and click **Settings**.

The screenshot shows the 'Add Standard TCP/IP Printer Port Wizard' dialog box at the 'Additional Port Information Required' step. The title bar reads 'Add Standard TCP/IP Printer Port Wizard'. The main heading is 'Additional Port Information Required' with the instruction 'The device could not be identified.' Below this, it says 'The device is not found on the network. Be sure that:' followed by a list of four items: 1. The device is turned on. 2. The network is connected. 3. The device is properly configured. 4. The address on the previous page is correct. Below the list, it says 'If you think the address is not correct, click Back to return to the previous page. Then correct the address and perform another search on the network. If you are sure the address is correct, select the device type below.' There is a 'Device Type' section with two radio buttons: 'Standard' (selected) and 'Custom' (selected). The 'Standard' option has a dropdown menu showing 'Generic Network Card'. The 'Custom' option has a 'Settings...' button. At the bottom, there are three buttons: '< Back', 'Next >', and 'Cancel'.

- 9 Confirm the IP address of the ZyXEL Device in the IP Address field.

- 10 Select **Raw** under **Protocol**.

11 The **Port Number** is automatically configured as **9100**. Click **OK**.

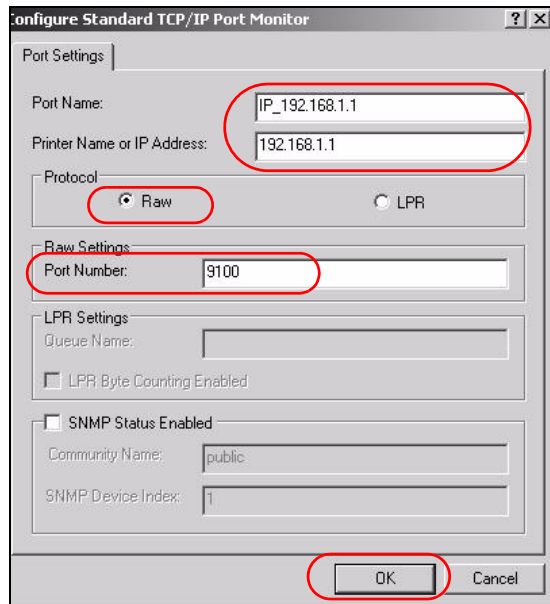

12 Continue through the wizard, apply your settings and close the wizard window.

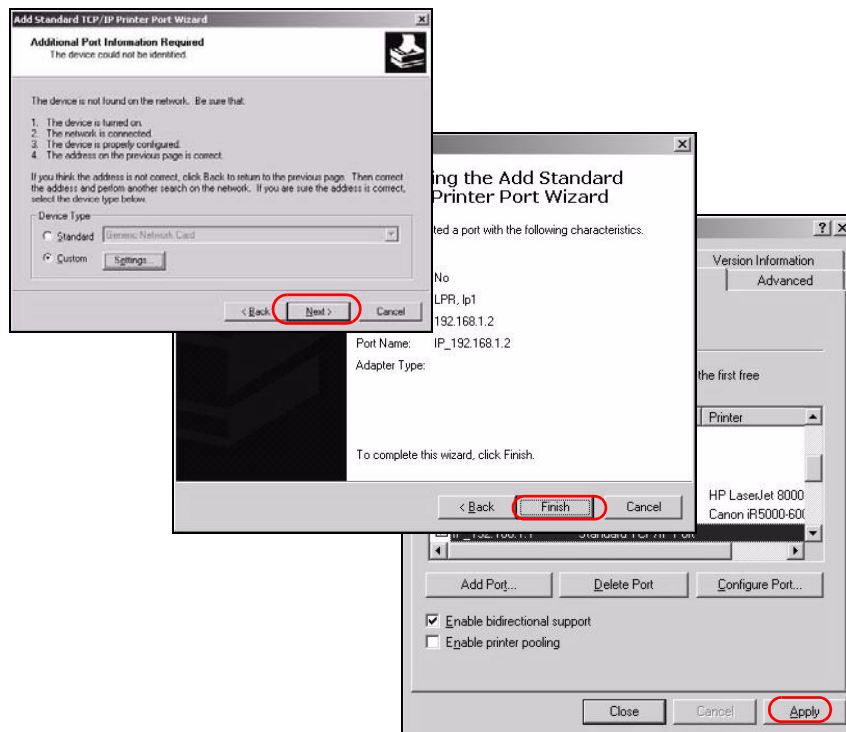

13 Repeat steps 1 to 12 to add this printer to other computers on your network.

Add a New Printer Using Windows

This example shows how to connect a printer to your ZyXEL Device using the Windows XP Professional operating system. Some menu items may look different on your operating system.

- 1 Click **Start > Control Panel > Printers and Faxes** to open the **Printers and Faxes** screen. Click **Add a Printer**.

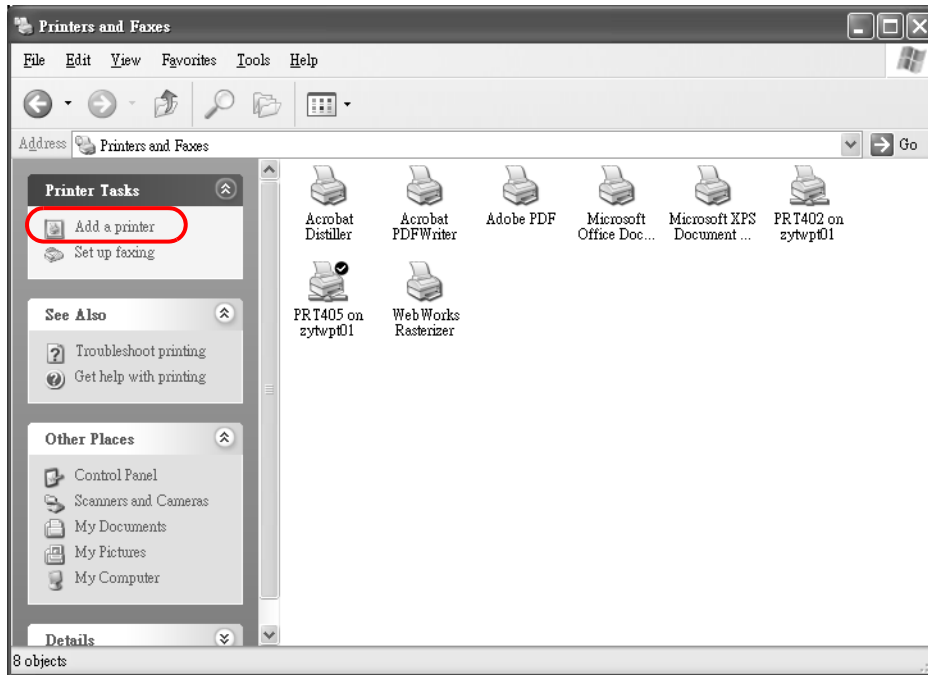

- 2 The **Add Printer Wizard** screen displays. Click **Next**.

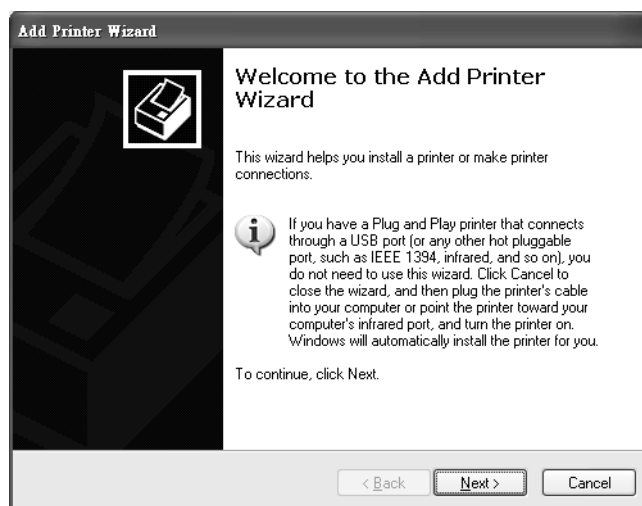

- 3 Select **Local printer attached to this computer** and click **Next**.

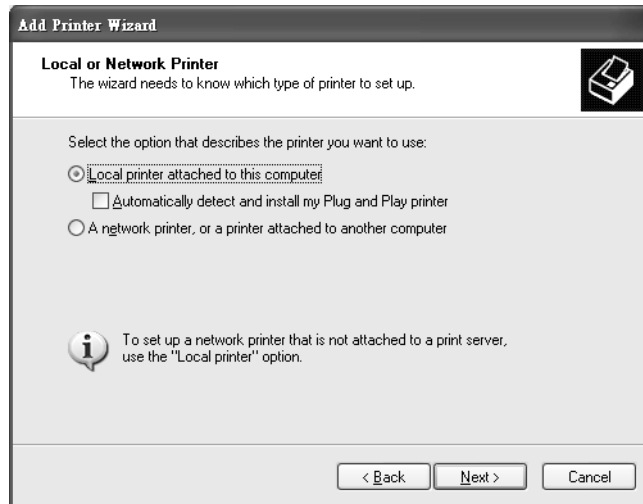

- 4 Select **Create a new port** and **Standard TCP/IP Port**. Click **Next**.

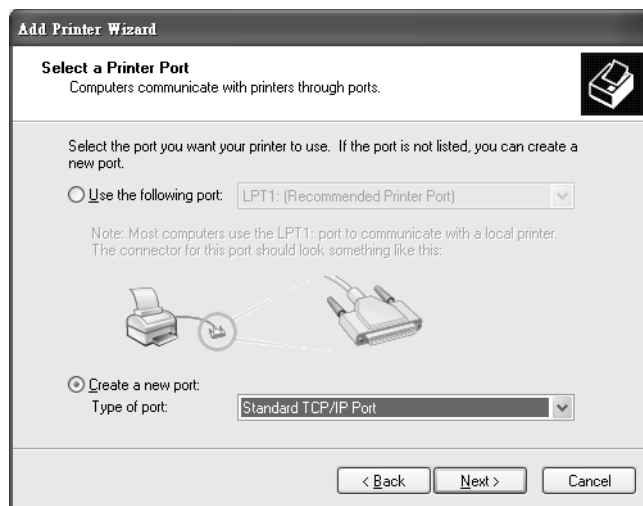

- 5 **Add Standard TCP/IP Printer Port Wizard** window opens up. Click **Next** to start configuring the printer port.

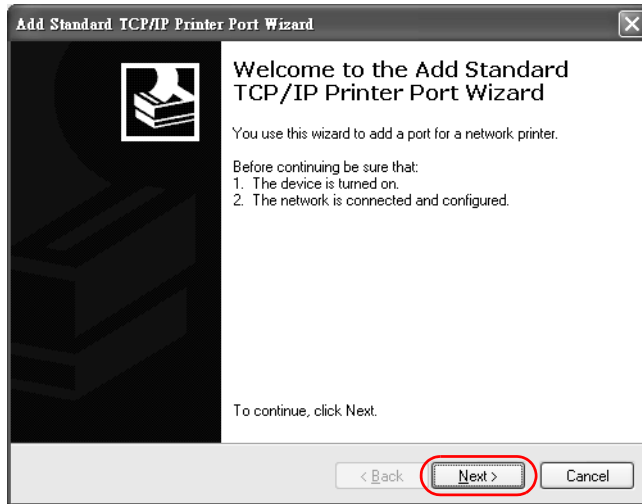

- 6 Enter the IP address of the ZyXEL Device to which the printer is connected in the **Printer Name or IP Address:** field. In our example we use the default IP address of the ZyXEL Device, 192.168.1.1. The **Port Name** field updates automatically to reflect the IP address of the port. Click **Next**.

Note: The computer from which you are configuring the TCP/IP printer port must be on the same LAN in order to use the printer sharing function.

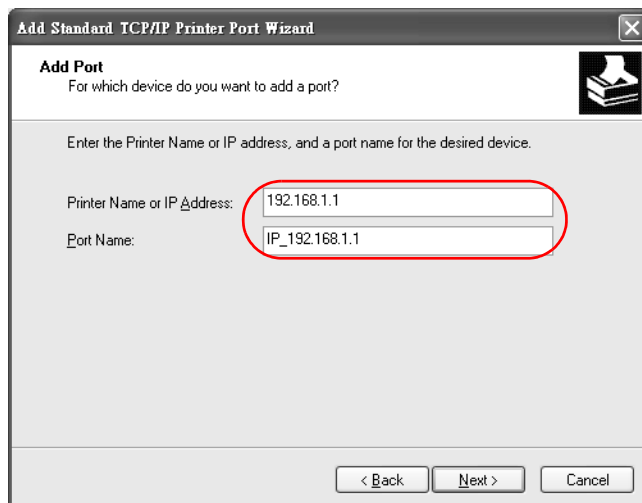

- 7 Select **Custom** under **Device Type** and click **Settings**.

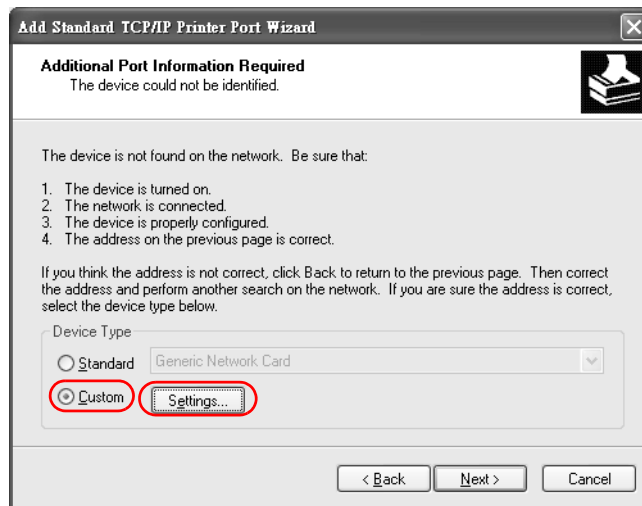

- 8 Confirm the IP address of the ZyXEL Device in the Printer **Name or IP Address** field.
- 9 Select **Raw** under **Protocol**.
- 10 The **Port Number** is automatically configured as **9100**. Click **OK** to go back to the previous screen and click **Next**.

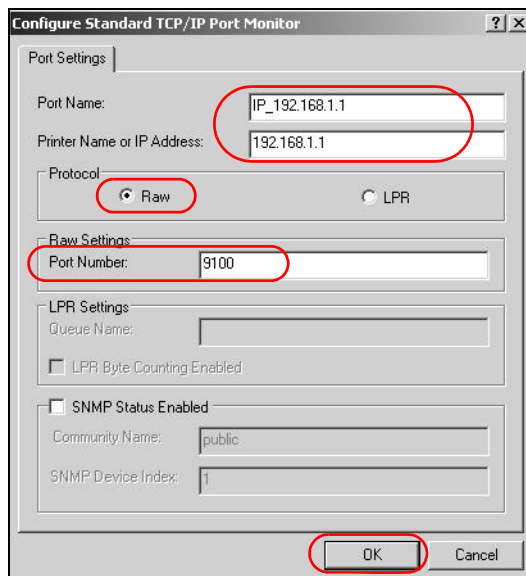

- 11 Click **Finish** to close the wizard window.

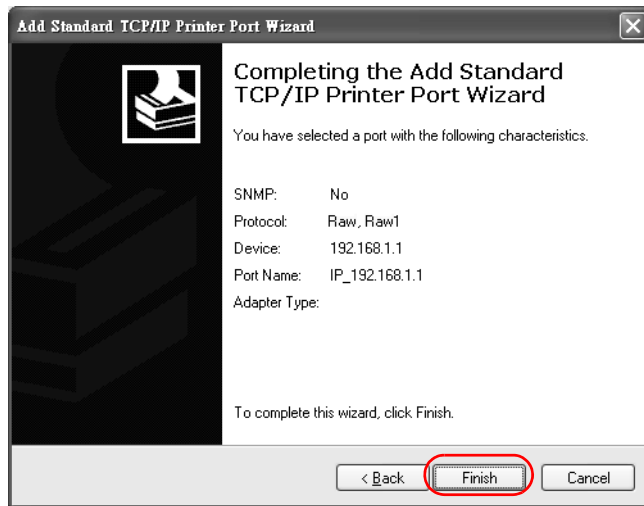

- 12 Select the make of the printer that you want to connect to the print server in the **Manufacturer** list of printers.
- 13 Select the printer model from the list of **Printers**.
- 14 If your printer is not displayed in the list of **Printers**, you can insert the printer driver installation CD/disk or download the driver file to your computer, click **Have Disk...** and install the new printer driver.
- 15 Click **Next** to continue.

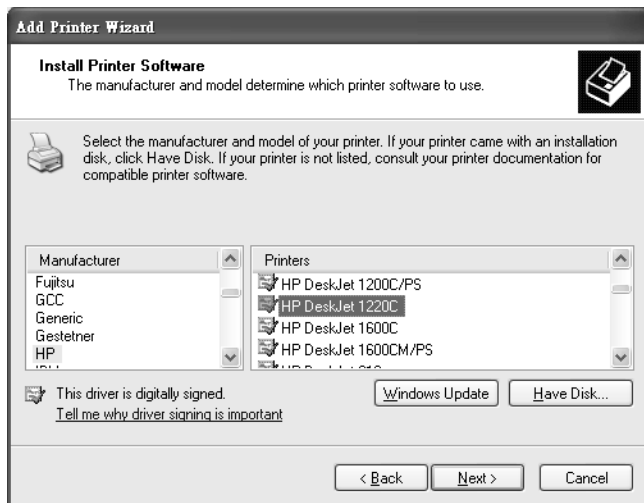

- 16 If the following screen displays, select **Keep existing driver** radio button and click **Next** if you already have a printer driver installed on your computer and you do not want to change it. Otherwise, select **Replace existing driver** to replace it with the new driver you selected in the previous screen and click **Next**.

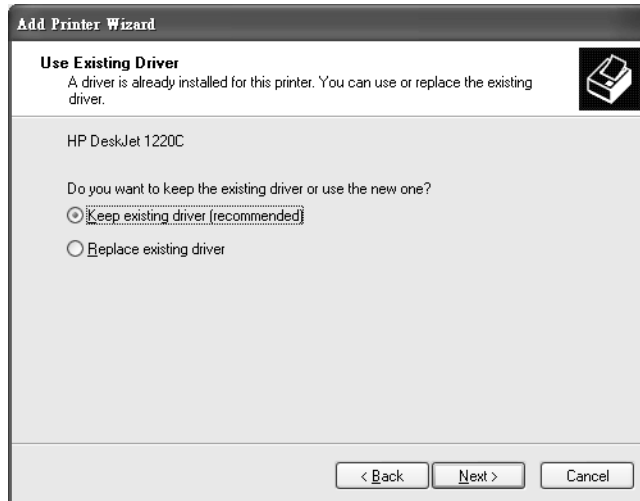

- 17 Type a name to identify the printer and then click **Next** to continue.

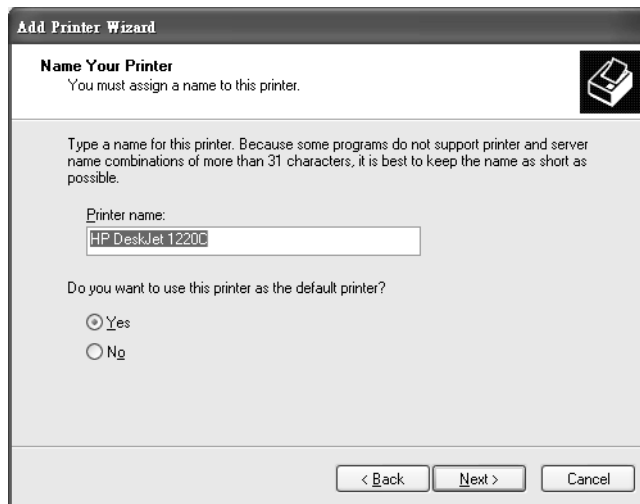

- 18 The ZyXEL Device is a print server itself and you do not need to have your computer act as a print server by sharing the printer with other users in the same

network; just select **Do not share this printer** and click **Next** to proceed to the following screen.

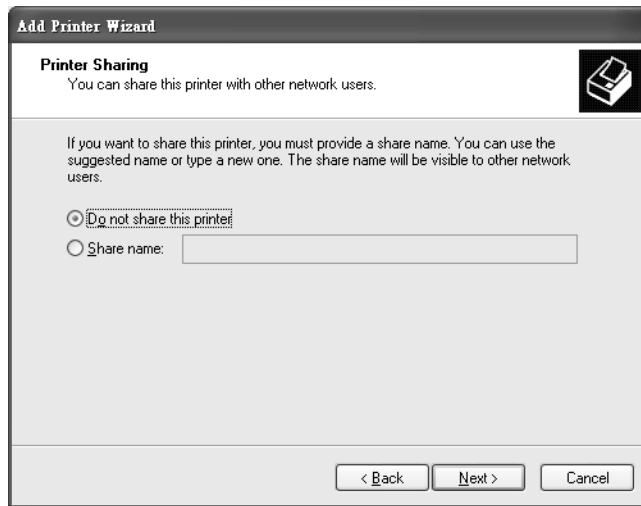

- 19 Select **Yes** and then click the **Next** button if you want to print a test page. A pop-up screen displays to ask if the test page printed correctly. Otherwise select **No** and then click **Next** to continue.

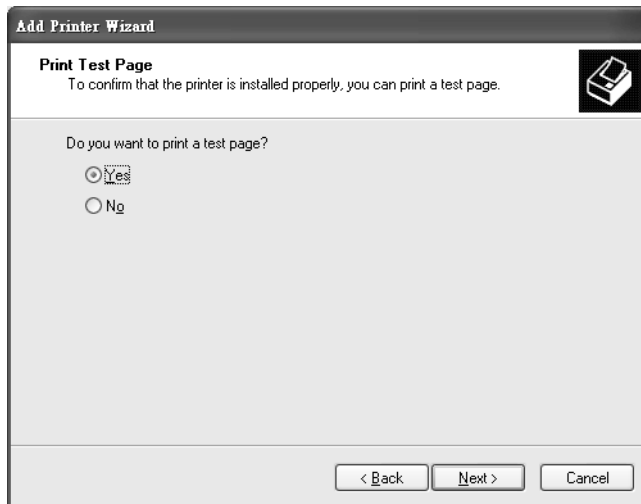

- 20 The following screen shows your current printer settings. Select **Finish** to complete adding a new printer.

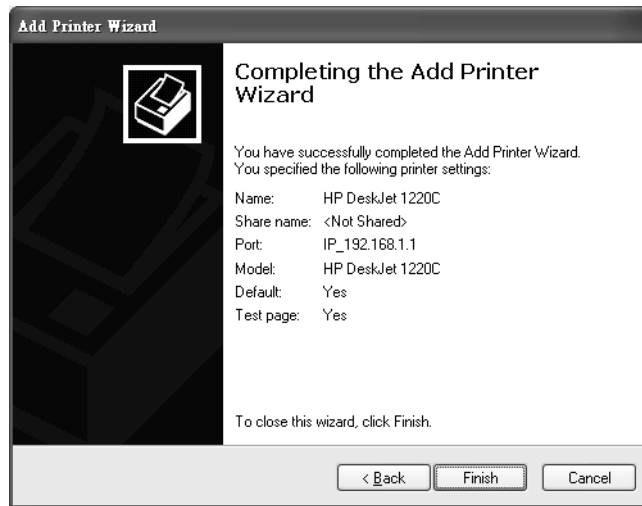

Add a New Printer Using Macintosh OS X

Complete the following steps to set up a print server driver on your Macintosh computer.

- 1 Click the **Print Center** icon  located in the Macintosh Dock (a place holding a series of icons/shortcuts at the bottom of the desktop). Proceed to step 6 to continue. If the **Print Center** icon is not in the Macintosh Dock, proceed to the next step.
- 2 On your desktop, double-click the **Macintosh HD** icon to open the **Macintosh HD** window.

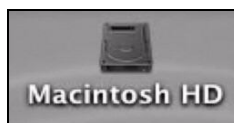

- 3 Double-click the **Applications** folder.

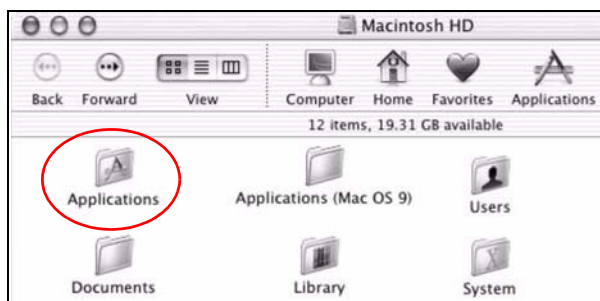

- 4 Double-click the **Utilities** folder.

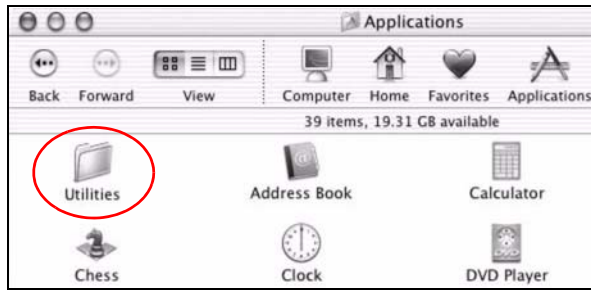

- 5 Double-click the **Print Center** icon.

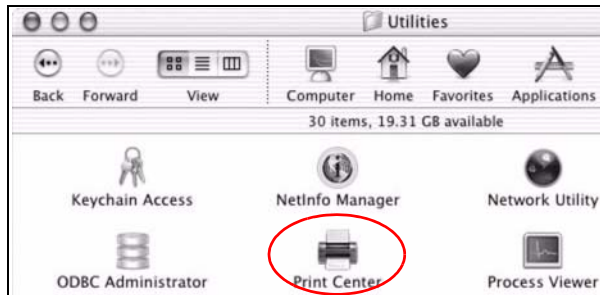

- 6 Click the **Add** icon at the top of the screen.

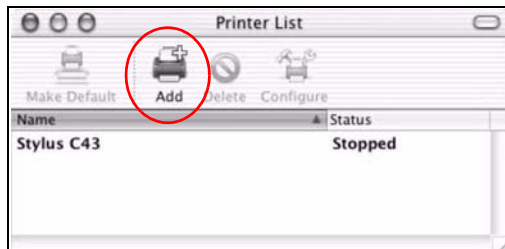

- 7 Set up your printer in the **Printer List** configuration screen. Select **IP Printing** from the drop-down list box.
- 8 In the **Printer's Address** field, type the IP address of your ZyXEL Device.
- 9 Deselect the **Use default queue on server** check box.
- 10 Type **LP1** in the **Queue Name** field.

- 11 Select your **Printer Model** from the drop-down list box. If the printer's model is not listed, select **Generic**.

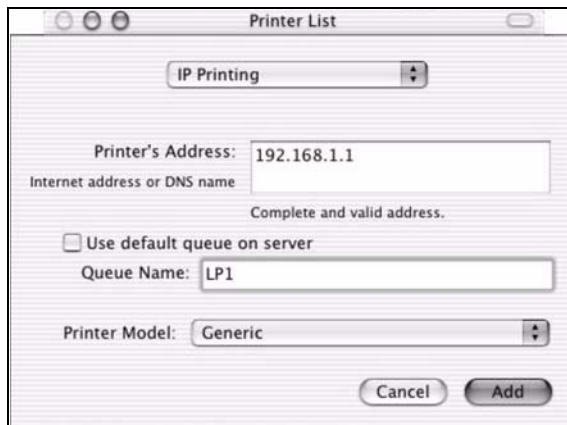

- 12 Click **Add** to select a printer model, save and close the **Printer List** configuration screen.

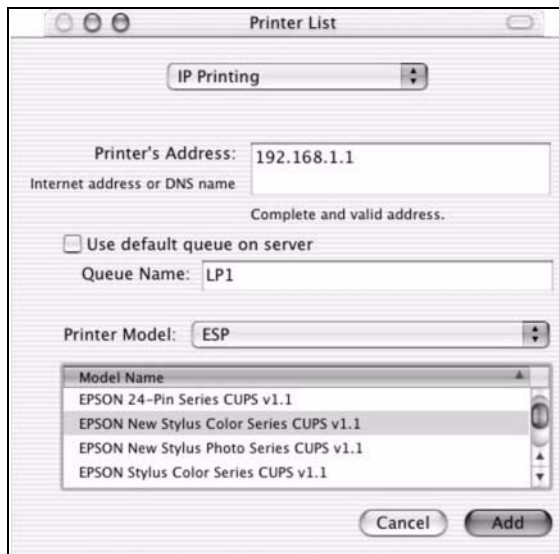

- 13 The **Name LP1 on 192.168.1.1** displays in the **Printer List** field. The default printer **Name** displays in bold type.

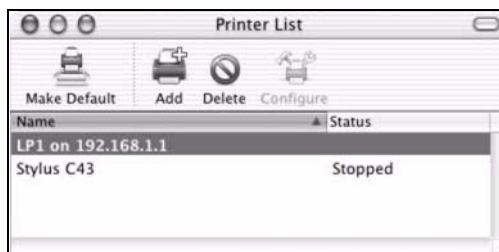

Your Macintosh print server driver setup is complete. You can now use the ZyXEL Device's print server to print from a Macintosh computer.

3.9 Configuring the MAC Address Filter

Thomas noticed that his daughter Josephine spends too much time surfing the web and downloading media files. He decided to prevent Josephine from accessing the Internet so that she can concentrate on preparing for her final exams.

Josephine's computer connects wirelessly to the Internet through the ZyXEL Device. Thomas decides to use the **Security > MAC Filter** screen to grant wireless network access to his computer but not to Josephine's computer.

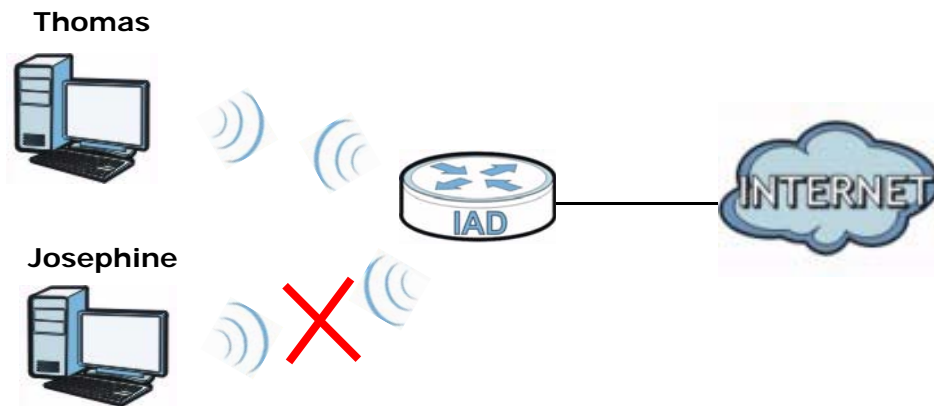

- 1 Click **Security > MAC Filter** to open the **MAC Filter** screen. Select the **Enable** check box to activate MAC filter function.
- 2 Find the MAC address of Thomas' computer in this screen. Select **Allow**. Click **Apply**.

MAC Address Filter: Enable Disable

Set	Allow	MAC Address
1	<input checked="" type="checkbox"/>	00:24:21:7E:20:96
2	<input type="checkbox"/>	
3	<input type="checkbox"/>	
4	<input type="checkbox"/>	
5	<input type="checkbox"/>	
6	<input type="checkbox"/>	
...		
30	<input type="checkbox"/>	
31	<input type="checkbox"/>	
32	<input type="checkbox"/>	

Note:
Only devices listed here are granted access to the network.

Apply Cancel

Thomas can also grant access to the computers of other members of his family and friends. However, Josephine and others not listed in this screen will no longer be able to access the Internet through the ZyXEL Device.

3.10 Configuring Static Route for Routing to Another Network

In order to extend your Intranet and control traffic flowing directions, you may connect a router to the ZyXEL Device's LAN. The router may be used to separate two department networks. This tutorial shows how to configure a static routing rule for two network routings.

In the following figure, router **R** is connected to the ZyXEL Device's LAN. **R** connects to two networks, **N1** (192.168.1.x/24) and **N2** (192.168.10.x/24). If you want to send traffic from computer **A** (in **N1** network) to computer **B** (in **N2** network), the traffic is sent to the ZyXEL Device's WAN default gateway by default. In this case, **B** will never receive the traffic.

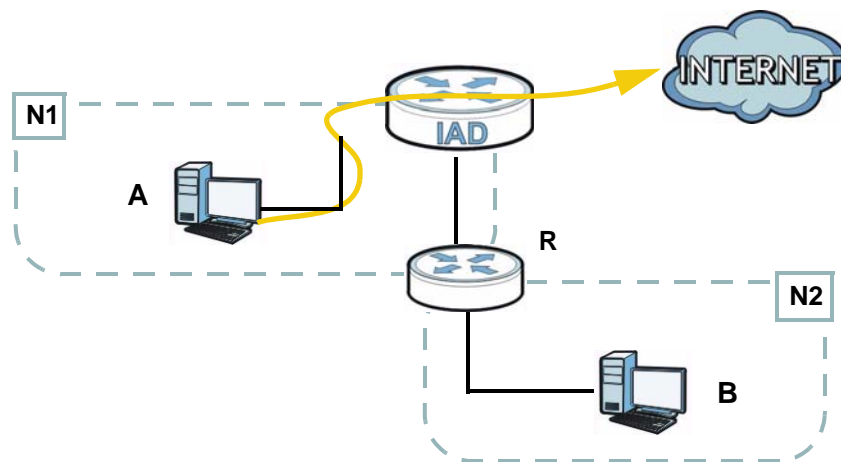

You need to specify a static routing rule on the ZyXEL Device to specify **R** as the router in charge of forwarding traffic to **N2**. In this case, the ZyXEL Device routes

traffic from **A** to **R** and then **R** routes the traffic to **B**. This tutorial uses the following example IP settings:

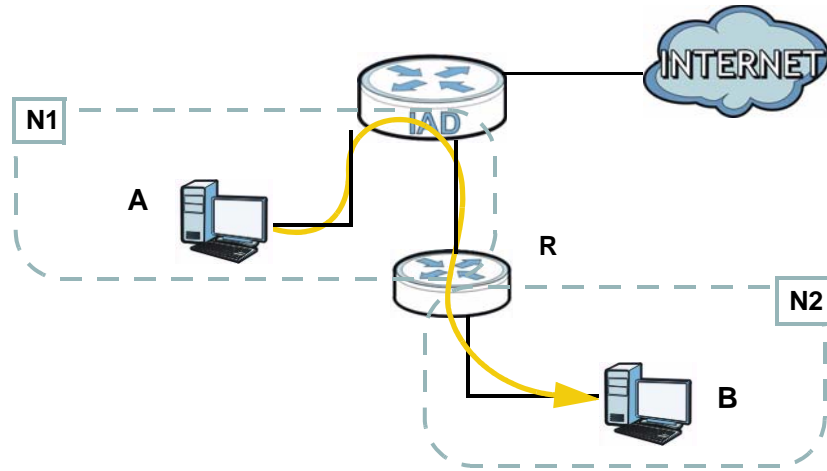

Table 3 IP Settings in this Tutorial

DEVICE / COMPUTER	IP ADDRESS
The ZyXEL Device's WAN	172.16.1.1
The ZyXEL Device's LAN	192.168.1.1
A	192.168.1.34
R's N1	192.168.1.253
R's N2	192.168.10.2
B	192.168.10.33

To configure a static route to route traffic from **N1** to **N2**:

- 1 Click **Network Setting > Routing**. Click **Add New Static Route**.



- 2 Configure the **Static Route Setup** screen using the following settings:
 - Select **Active**.
 - Specify a descriptive name for this routing rule.
 - Type **192.168.10.0** and subnet mask **255.255.255.0** for the destination, **N2**.

- Type **192.168.1.253** (R's N1 address) in the **Gateway IP Address** field.

Click **Apply**. The **Routing** screen should display the route you just added.

Add New Static Route									
#	Active	Status	MName	Destination IP	Gateway	Subnet Mask	Interface	Modify	
1			To_N2	192.168.10.0	192.168.1.253	255.255.255.0	LAN/br0		

Now **B** should be able to receive traffic from **A**. You may need to additionally configure **B**'s firewall settings to allow specific traffic to pass through.

3.11 Configuring QoS Queue and Class Setup

This section contains tutorials on how you can configure the QoS screen.

Note: Voice traffic will not be affected by the user-defined QoS settings on the ZyXEL Device. It always gets the highest priority.

Let's say you are a team leader of a small sales branch office. You want to prioritize e-mail traffic because your task includes sending urgent updates to clients at least twice every hour. You also upload data files (such as logs and e-mail archives) to the FTP server throughout the day. Your colleagues use the Internet for research, as well as chat applications for communicating with other branch offices.

In the following figure, your Internet connection has an upstream transmission bandwidth of 10,000 kbps. For this example, you want to configure QoS so that e-mail traffic gets the highest priority with at least 5,000 kbps. You can do the following:

- Configure a queue to assign the highest priority queue (7) to e-mail traffic from the LAN interface, so that e-mail traffic would not get delayed when there is network congestion.
- Note the IP address (192.168.1.23 for example) and/or MAC address (AA:FF:AA:FF:AA:FF for example) of your computer and map it to queue 7.

Note: QoS is applied to traffic flowing out of the ZyXEL Device.

Traffic that does not match this class is assigned a priority queue based on the internal QoS mapping table on the ZyXEL Device.

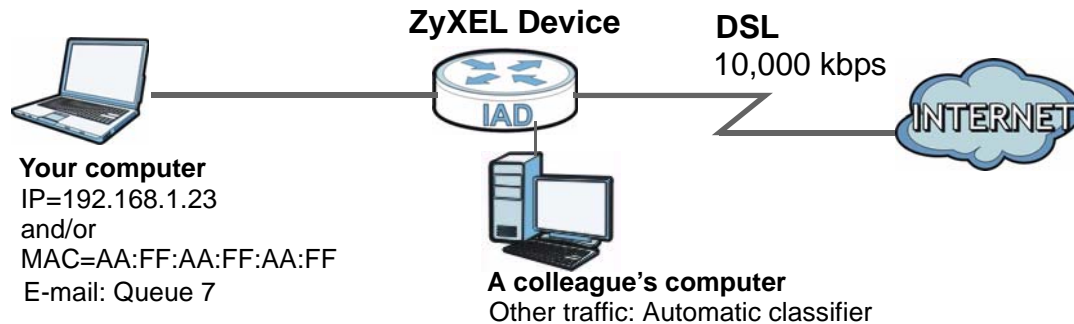

- 1 Click **Network Setting > QoS > General** and check **Active**. Set your **WAN Managed Upstream Bandwidth** to 10,000 kbps (or leave this blank to have the ZyXEL Device automatically determine this figure). Click **Apply** to save your settings.

The screenshot shows the "General" settings for QoS. The "Active QoS" checkbox is checked. Below it, the "WAN Managed Upstream Bandwidth" is set to "10000" (kbps). The "Traffic priority will be automatically assigned by" dropdown menu is set to "None". A "Note" section provides additional information: "You can assign the upstream bandwidth manually. If the field is empty, the CPE set the value automatically. If Enable QoS checkbox is selected, choose an automapping type to assign traffic priority automatically." There are "Apply" and "Cancel" buttons at the bottom right.

- 2 Go to **Network Setting > QoS > Queue Setup**. Click **Add new Queue** to create a new queue. In the screen that opens, check **Active** and enter or select the following values, then click **Apply**.
 - **Name:** Email
 - **Priority:** 7 (High)
 - **Weight:** 15

- **Rate Limit:** 5,000 (kbps)

<input checked="" type="checkbox"/> Active	
Name :	Email
Priority :	7(High)
Weight :	15
Rate Limit :	5000 (kbps)
<input type="button" value="Apply"/> <input type="button" value="Back"/>	

- 3 Go to **Network Setting > QoS > Class Setup**. Click **Add new Classifier** to create a new class. Check **Active** and follow the settings as shown in the screen below. Then click **Apply**.

Class Configuration					
Active :	<input checked="" type="checkbox"/>				
Class Name :	Email				
Classification Order :	1				
Forward To Interface :	Unchange				
DSCP Mark :	Unchange (0-63)				
To Queue :	Email				
Criteria Configuration					
Use the configurations below to specify the characteristics of a data flow need to be managed by this QoS rule					
Basic					
<input checked="" type="checkbox"/> From Interface	Lan				
<input checked="" type="checkbox"/> Ether Type	IP (0x0800)				
Source					
<input checked="" type="checkbox"/> MAC Address	AA:FF:AA:FF:AA:FF	MAC Mask		<input type="checkbox"/>	Exclude
<input checked="" type="checkbox"/> IP Address	192.168.1.23	IP Subnet Mask		<input type="checkbox"/>	Exclude
<input type="checkbox"/> Port Range			(1-65535)	<input type="checkbox"/>	Exclude
Destination					
<input type="checkbox"/> MAC Address		MAC Mask		<input type="checkbox"/>	Exclude
<input type="checkbox"/> IP Address		IP Subnet Mask		<input type="checkbox"/>	Exclude
<input type="checkbox"/> Port Range			(1-65535)	<input type="checkbox"/>	Exclude
Others					
<input checked="" type="checkbox"/> IP Protocol	User defined	25		<input type="checkbox"/>	Exclude
<input type="checkbox"/> IP Packet Length			(46-1504)	<input type="checkbox"/>	Exclude
<input type="checkbox"/> DSCP				<input type="checkbox"/>	Exclude
<input type="checkbox"/> TCP ACK				<input type="checkbox"/>	Exclude
<input type="checkbox"/> DHCP	VendorClassID (DHCP Option 60)			<input type="checkbox"/>	Exclude
	Class ID		(String)		
<input type="checkbox"/> Service	FTP			<input type="checkbox"/>	Exclude
<input type="button" value="Apply"/> <input type="button" value="Back"/>					

Class Name	Give a class name to this traffic, such as Email in this example.
To Queue	Link this to a queue created in the QoS > Queue Setup screen, which is the Email queue created in this example.

From Interface	This is the interface from which the traffic will be coming from. Select Lan .
Ether Type	Select IP to identify the traffic source by its IP address or MAC address.
MAC Address	Type the MAC address of your computer - AA:FF:AA:FF:AA:FF . Type the MAC Mask if you know it.
IP Address	Type the IP address of your computer - 192.168.1.23 . Type the IP Subnet Mask if you know it.

This maps e-mail traffic to queue 7 created in the previous screen (see the **IP Protocol** field). This also maps your computer's IP address and MAC address to queue 7 (see the **Source** fields).

- 4 Verify that the queue setup works by checking **Network Setting > QoS > Monitor**. This shows the bandwidth allotted to e-mail traffic compared to other network traffic.

Monitor			
Refresh Interval :	5 seconds		
Status :			
▪ Interface Monitor			
#	Name	Pass Rate(bps)	
1	nas1	0	
2	ppp0		
▪ Queue Monitor			
#	Name	Pass Rate(bps)	Drop Rate(bps)
1	Default Queue	0	0
2	Email	2992	0

3.12 Access the ZyXEL Device Using DDNS

If you connect your ZyXEL Device to the Internet and it uses a dynamic WAN IP address, it is inconvenient for you to manage the device from the Internet. The

ZyXEL Device's WAN IP address changes dynamically. Dynamic DNS (DDNS) allows you to access the ZyXEL Device using a domain name.



To use this feature, you have to apply for DDNS service at www.dyndns.org.

This tutorial shows you how to:

- [Registering a DDNS Account on \[www.dyndns.org\]\(http://www.dyndns.org\)](#)
- [Configuring DDNS on Your ZyXEL Device](#)
- [Testing the DDNS Setting](#)

Note: If you have a private WAN IP address, then you cannot use DDNS.

3.12.1 Registering a DDNS Account on www.dyndns.org

- 1 Open a browser and type **<http://www.dyndns.org>**.
- 2 Apply for a user account. This tutorial uses **UserName1** and **12345** as the username and password.
- 3 Log into www.dyndns.org using your account.
- 4 Add a new DDNS host name. This tutorial uses the following settings as an example.
 - Hostname: **zyxelrouter.dyndns.org**
 - Service Type: **Host with IP address**
 - IP Address: Enter the WAN IP address that your ZyXEL Device is currently using. You can find the IP address on the ZyXEL Device's web configurator **Status** page.

Then you will need to configure the same account and host name on the ZyXEL Device later.

3.12.2 Configuring DDNS on Your ZyXEL Device

Configure the following settings in the **Network Setting** > **DNS** screen.

- Select **Active Dynamic DNS**.
- Select **Dynamic DNS** for the DDNS type.
- Type **zyxelrouter.dyndns.org** in the **Host Name** field.
- Enter the user name (**UserName1**) and password (**12345**).

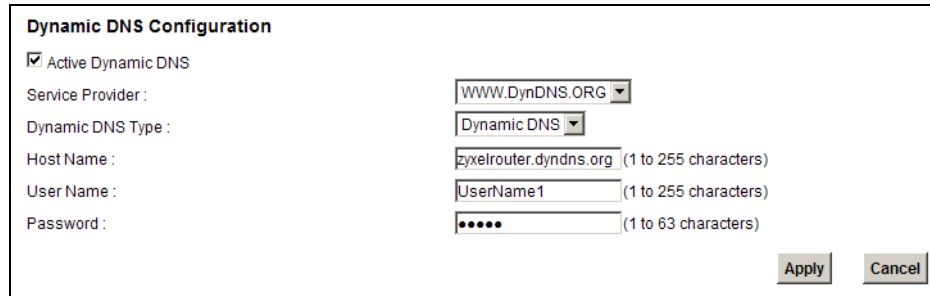

Dynamic DNS Configuration

Active Dynamic DNS

Service Provider : WWW.DynDNS.ORG

Dynamic DNS Type : Dynamic DNS

Host Name : zyxelrouter.dyndns.org (1 to 255 characters)

User Name : UserName1 (1 to 255 characters)

Password : (1 to 63 characters)

Apply Cancel

Click **Apply**.

3.12.3 Testing the DDNS Setting

Now you should be able to access the ZyXEL Device from the Internet. To test this:

- 1 Open a web browser on the computer (using the IP address **a.b.c.d**) that is connected to the Internet.
- 2 Type **http://zyxelrouter.dyndns.org** and press [Enter].
- 3 The ZyXEL Device's login page should appear. You can then log into the ZyXEL Device and manage it.

PART II

Technical Reference

Connection Status and System Info Screens

4.1 Overview

After you log into the web configurator, the **Connection Status** screen appears. This shows the network connection status of the ZyXEL Device and clients connected to it.

Use the **System Info** screen to look at the current status of the device, system resources, interfaces (LAN, WAN and WLAN), and SIP accounts. You can also register and unregister SIP accounts.

4.2 The Connection Status Screen

Use this screen to view the network connection status of the device and its clients. A warning message appears if there is a connection problem.

If you prefer to view the status in a list, click **List View** in the **Viewing mode** selection box. You can configure how often you want the ZyXEL Device to update this screen in **Refresh Interval**.

Figure 11 Connection Status: Icon View

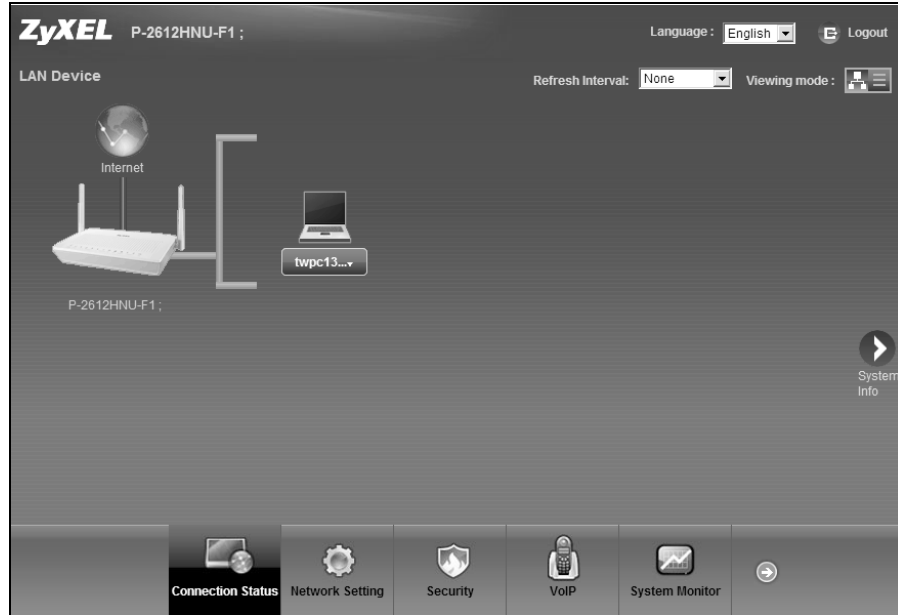
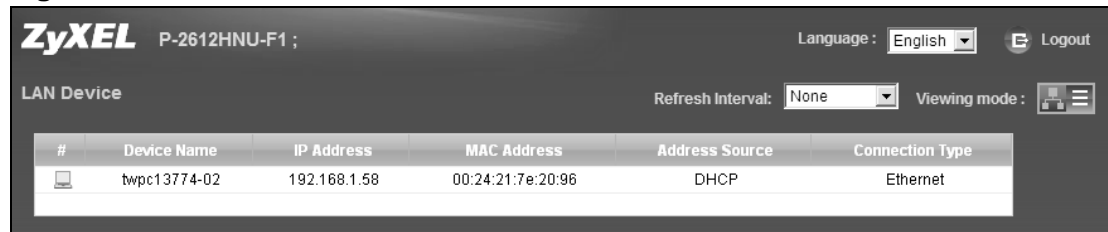

Figure 12 Connection Status: List View



In **Icon View**, if you want to view information about a client, click the client's name and **Info**. Click the IP address if you want to change it. If you want to change the name or icon of the client, click **Change name/icon**.

In **List View**, you can also view the client's information.

4.3 The System Info Screen

Click **Connection Status > System Info** to open this screen.

Figure 13 System Info Screen

The screenshot shows the ZyXEL P-2612HNU-F1 System Info screen. At the top, it displays the device name and model, the language (English), and a Logout button. Below this, there are several sections:

- Device Information:** Lists Host Name (P-2612HNU-F1), Model Name (P-2612HNU-F1), MAC Address (40:4a:03:ff:5b:e7), Firmware Version (V3.10(BLT.0)b3), WAN 1 Information (ADSL WAN 1), LAN Information (IP Address: 192.168.1.1, Subnet Mask: 255.255.255.0, DHCP Server: Server), WLAN Information (Channel: 1, WPS Status: Unconfigured), and four SSID entries (SSID1-4) with their respective SSIDs, statuses, and security modes.
- Interface Status:** A table showing the status and rate of various interfaces:

Interface	Status	Rate
ADSL WAN	Down	N/A
LAN 1	Down	N/A
LAN 2	Up	1000Mbps
LAN 3	Down	N/A
LAN 4	Down	N/A
WLAN	Up	300Mbps
3G	Disabled	N/A
- System Status:** Shows System Up Time (8 min), Current Date/Time (Sat Jan 1 00:08:41 UTC 2000), and System Resource usage: CPU (1.0%), Memory (67.8%), and Power (4W to 14W).
- USB Status:** A table showing the status of connected USB devices:

Type	Status
Storage	N/A
Printer	N/A
- Registration Status:** A table showing SIP account registration details:

Account	Action	Account Status	URI
SIP 1	Register	In-Active	ChangeMe@ChangeMe
SIP 2	Register	In-Active	ChangeMe@ChangeMe

Each field is described in the following table.

Table 4 System Info Screen

LABEL	DESCRIPTION
Language	Select the web configurator language from the drop-down list box.
Refresh Interval	Select how often you want the ZyXEL Device to update this screen from the drop-down list box.
Device Information	
Host Name	This field displays the ZyXEL Device system name. It is used for identification. You can change this in the Maintenance > System screen's Host Name field.
Model Name	This is the model name of your device.
MAC Address	This is the MAC (Media Access Control) or Ethernet address unique to your ZyXEL Device.

LABEL	DESCRIPTION
Firmware Version	This field displays the current version of the firmware inside the device. It also shows the date the firmware version was created. Go to the Maintenance > Firmware Upgrade screen to change it.
WAN Information	
Mode	This is the method of encapsulation used by your ISP.
IP Address	This field displays the current IP address of the ZyXEL Device in the WAN.
IP Subnet Mask	This field displays the current subnet mask in the WAN.
LAN Information	
IP Address	This field displays the current IP address of the ZyXEL Device in the LAN.
IP Subnet Mask	This field displays the current subnet mask in the LAN.
DHCP Server	This field displays what DHCP services the ZyXEL Device is providing to the LAN. Choices are: Server - The ZyXEL Device is a DHCP server in the LAN. It assigns IP addresses to other computers in the LAN. Relay - The ZyXEL Device acts as a surrogate DHCP server and relays DHCP requests and responses between the remote server and the clients. None - The ZyXEL Device is not providing any DHCP services to the LAN.
WLAN Information	
Channel	This is the channel number used by the ZyXEL Device now.
WPS Status	Configured displays when a wireless client has connected to the ZyXEL Device or WPS is enabled and wireless or wireless security settings have been configured. Unconfigured displays if WPS is disabled or wireless security settings have not been configured.
SSID (1~4) Information	
SSID	This is the descriptive name used to identify the ZyXEL Device in the wireless LAN.
Status	This shows whether or not the SSID is enabled (on).
Security Mode	This displays the type of security the ZyXEL Device is using in the wireless LAN.
Interface Status	
Interface	This column displays each interface the ZyXEL Device has.

LABEL	DESCRIPTION
Status	<p>This field indicates whether or not the ZyXEL Device is using the interface.</p> <p>For the DSL interface, this field displays Down (line is down), Up (line is up or connected) if you're using Ethernet encapsulation and Down (line is down), Up (line is up or connected), Idle (line (ppp) idle), Dial (starting to trigger a call) and Drop (dropping a call) if you're using PPPoE encapsulation.</p> <p>For the WAN interface, this field displays Up when the ZyXEL Device is using the interface and Down when the ZyXEL Device is not using the interface.</p> <p>For the LAN interface, this field displays Up when the ZyXEL Device is using the interface and Down when the ZyXEL Device is not using the interface.</p> <p>For the WLAN interface, it displays Active when WLAN is enabled or InActive when WLAN is disabled.</p>
Speed	<p>For the LAN interface, this displays the port speed and duplex setting.</p> <p>For the WAN interface, this displays the port speed and duplex setting.</p> <p>For the DSL interface, it displays the downstream and upstream transmission rate.</p> <p>For the WLAN interface, it displays the maximum transmission rate when WLAN is enabled or N/A when WLAN is disabled.</p>
System Status	
System Uptime	<p>This field displays how long the ZyXEL Device has been running since it last started up. The ZyXEL Device starts up when you plug it in, when you restart it (Maintenance > Reboot), or when you reset it (see Chapter 1 on page 28).</p>
Current Date/Time	<p>This field displays the current date and time in the ZyXEL Device. You can change this in Maintenance > Time Setting.</p>
System Resource	
CPU Usage	<p>This field displays what percentage of the ZyXEL Device's processing ability is currently used. When this percentage is close to 100%, the ZyXEL Device is running at full load, and the throughput is not going to improve anymore. If you want some applications to have more throughput, you should turn off other applications.</p>
Memory Usage	<p>This field displays what percentage of the ZyXEL Device's memory is currently used. Usually, this percentage should not increase much. If memory usage does get close to 100%, the ZyXEL Device is probably becoming unstable, and you should restart the device. See Chapter 25 on page 285, or turn off the device (unplug the power) for a few seconds.</p>
Power Usage	<p>This field displays what percentage of traffic passing through the ZyXEL Device is using NAT.</p>
USB Status	
Type	<p>This shows the type of device connected to the ZyXEL Device.</p>

LABEL	DESCRIPTION
Status	This shows whether the device is currently active (Up). This shows N/A if there are no device connected to the ZyXEL Device or the connected device is not working.
Registration Status	
Account	This column displays each SIP account in the ZyXEL Device.
Action	<p>This field displays the current registration status of the SIP account. You have to register SIP accounts with a SIP server to use VoIP.</p> <p>If the SIP account is already registered with the SIP server,</p> <ul style="list-style-type: none"> • Click Unregister to delete the SIP account's registration in the SIP server. This does not cancel your SIP account, but it deletes the mapping between your SIP identity and your IP address or domain name. • The second field displays Registered. <p>If the SIP account is not registered with the SIP server,</p> <ul style="list-style-type: none"> • Click Register to have the ZyXEL Device attempt to register the SIP account with the SIP server. • The second field displays the reason the account is not registered. <p>Inactive - The SIP account is not active. You can activate it in VoIP > SIP > SIP Settings.</p> <p>Register Fail - The last time the ZyXEL Device tried to register the SIP account with the SIP server, the attempt failed. The ZyXEL Device automatically tries to register the SIP account when you turn on the ZyXEL Device or when you activate it.</p>
Account Status	This shows Active when the SIP account has been registered and ready for use or In-Active when the SIP account is not yet registered.
URI	This field displays the account number and service domain of the SIP account. You can change these in VoIP > SIP > SIP Settings .

Broadband

5.1 Overview

This chapter discusses the ZyXEL Device's **Broadband** screens. Use these screens to configure your ZyXEL Device for Internet access.

A WAN (Wide Area Network) connection is an outside connection to another network or the Internet. It connects your private networks, such as a LAN (Local Area Network) and other networks, so that a computer in one location can communicate with computers in other locations.

Figure 14 LAN and WAN

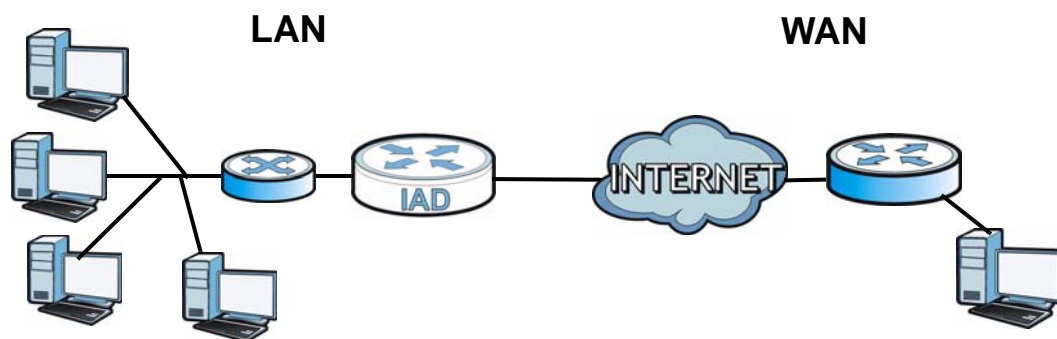

3G (third generation) standards for the sending and receiving of voice, video, and data in a mobile environment.

You can attach a 3G wireless adapter to the USB port and set the ZyXEL Device to use this 3G connection as your WAN or a backup when the wired WAN connection fails.

Figure 15 3G WAN Connection

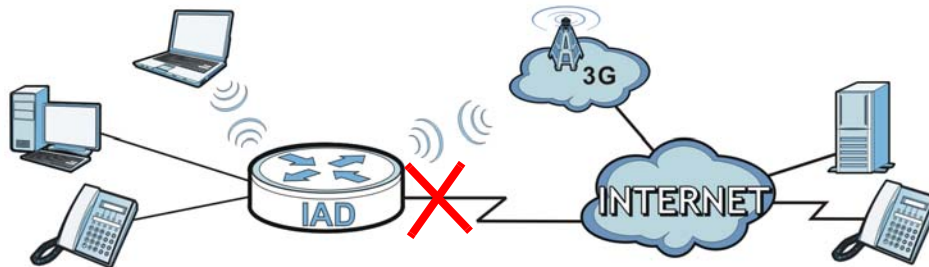

5.1.1 What You Can Do in this Chapter

- Use the **Broadband** screen to view, remove or add a WAN interface. You can also configure the WAN settings on the ZyXEL Device for Internet access ([Section 5.2 on page 98](#)).
- Use the **3G Backup** screen to configure 3G WAN connection ([Section 5.3 on page 112](#)).

Table 5 WAN Setup Overview

LAYER-2 INTERFACE		INTERNET CONNECTION		
INTERFACE	DSL LINK TYPE	MODE	WAN SERVICE TYPE	CONNECTION SETTINGS
Ethernet		Routing	PPPoE	PPP user name and password, WAN IP address, DNS server and default gateway
			IPoE	WAN IP address, NAT, DNS server and default gateway
		Bridge	N/A	N/A
ATM	EoA	Routing	PPPoE	PPP user name and password, WAN IP address, DNS server and default gateway
			IPoE	WAN IP address, NAT, DNS server and default gateway
		Bridge	N/A	N/A

5.1.2 What You Need to Know

The following terms and concepts may help as you read this chapter.

Encapsulation Method

Encapsulation is used to include data from an upper layer protocol into a lower layer protocol. To set up a WAN connection to the Internet, you need to use the same encapsulation method used by your ISP (Internet Service Provider). If your ISP offers a dial-up Internet connection using PPPoE (PPP over Ethernet), they should also provide a username and password (and service name) for user authentication.

WAN IP Address

The WAN IP address is an IP address for the ZyXEL Device, which makes it accessible from an outside network. It is used by the ZyXEL Device to communicate with other devices in other networks. It can be static (fixed) or dynamically assigned by the ISP each time the ZyXEL Device tries to access the Internet.

If your ISP assigns you a static WAN IP address, they should also assign you the subnet mask and DNS server IP address(es).

ATM

Asynchronous Transfer Mode (ATM) is a LAN and WAN networking technology that provides high-speed data transfer. ATM uses fixed-size packets of information called cells. With ATM, a high QoS (Quality of Service) can be guaranteed. ATM uses a connection-oriented model and establishes a virtual circuit (VC) between two endpoints before the actual data exchange begins.

3G

3G (Third Generation) is a digital, packet-switched wireless technology. Bandwidth usage is optimized as multiple users share the same channel and bandwidth is only allocated to users when they send data. It allows fast transfer of voice and non-voice data and provides broadband Internet access to mobile devices.

Finding Out More

- See [Section 5.4 on page 114](#) for advanced technical information on WAN and 3G.
- See [Chapter 3 on page 37](#) for WAN tutorials.

5.1.3 Before You Begin

You need to know your Internet access settings such as encapsulation and WAN IP address. Get this information from your ISP.

5.2 The Broadband Screen

The ZyXEL Device must have a WAN interface to allow users to use the Ethernet WAN port or DSL port to access the Internet. Use the **Broadband** screen to view, remove or add a WAN interface.

Note: The ATM and Ethernet layer-2 interfaces cannot work at the same time.

Click **Network Setting > Broadband**. The following screen opens.

Figure 16 Network Setting > Broadband

Add new WAN Interface								
Internet Setup								
#	Name	Type	Mode	Encapsulati...	VPI	VCI	Vlan8021p	VlanMuxid
1	EtherWAN1	EtherWAN	Routing	IPoE	N/A	N/A	0	N/A
2	AdslWAN1	ADSL	Routing	IPoE	8	35	N/A	N/A

ATM QoS	IGMP Proxy	NAT	Default Gat...	Modify
N/A	Enabled	Enabled	Y	
UBR	Enabled	Enabled	Y	

The following table describes the fields in this screen.

Table 6 Network Setting > Broadband

LABEL	DESCRIPTION
Add new WAN Interface	Click this to create a new WAN interface.
Internet Setup	
#	This is the index number of the connection.
Name	This is the service name of the connection.
Type	This shows the type of interface used by this connection.
Mode	This shows whether the connection is in routing mode or bridge mode.
Encapsulation	This shows the method of encapsulation used by this connection.
VPI	This is the Virtual Path Identifier (VPI).
VCI	This is the Virtual Channel Identifier (VCI).
Vlan8021p	This indicates the 802.1P priority level assigned to traffic sent through this connection. This displays N/A when there is no priority level assigned.
VlanMuxId	This indicates the VLAN ID number assigned to traffic sent through this connection. This displays N/A when there is no VLAN ID number assigned.
ATM QoS	This shows the ATM Quality of Service (QoS) type configured for this connection. This displays N/A when there is no ATM QoS assigned.

Table 6 Network Setting > Broadband (continued)

LABEL	DESCRIPTION
IGMP Proxy	This shows whether IGMP (Internet Group Multicast Protocol) is activated or not for this connection. IGMP is not available when the connection uses the bridging service.
NAT	This shows whether NAT is activated or not for this connection. NAT is not available when the connection uses the bridging service.
Default Gateway	This shows whether the ZyXEL Device uses the interface of this connection as the system default gateway.
Modify	Click the Edit icon to configure the connection. Click the Delete icon to delete this connection from the ZyXEL Device. A window displays asking you to confirm that you want to delete the connection.

5.2.1 Add/Edit Internet Connection

Use this screen to configure a WAN connection. The screen varies depending on the encapsulation and WAN service type you select.

5.2.1.1 Routing- PPPoE

Click the **Add new WAN Interface** in the **Network Setting > Broadband** screen or the **Edit** icon next to the connection you want to configure. Select **Routing** as the encapsulation mode and **PPPoE** as the WAN service type.

Figure 17 Broadband Add/Edit: Routing- PPPoE

General

Name :

Type :

Mode :

WANServiceType :

ATM PVC Configuration

VPI[0-255] :

VCI[32-65535] :

DSL Link Type :

Encapsulation Mode :

Service Category :

Peak Cell Rate[cells/s] :

Sustainable Cell Rate[cells/s] :

Maximum Burst Size [cells] :

PPP Information

PPPUserName :

PPPPassword :

PPPoEServiceName :

Authentication Method :

Use Static IP Address :

IP Address :

PPPoE Passthrough :

Routing Feature

NAT Enable :

IGMP Proxy Enable :

Apply as Default Gateway :

DNS Server

Obtain DNS info Automatically

Use the following Static DNS IP Address

Primary DNS Server :

Secondary DNS Server :

The following table describes the fields in this screen.

Table 7 Broadband Add/Edit: Routing- PPPoE

Label	DESCRIPTION
General	
Name	Enter a service name of the connection.
Type	Select an interface for which you want to configure here. ADSL: The ZyXEL Device uses the ADSL technology for data transmission over the DSL port. EtherWAN: The ZyXEL Device transmits data over the Ethernet WAN port. Select this if you have a DSL router or modem in your network already.
Mode	Select Routing (default) from the drop-down list box if your ISP give you one IP address only and you want multiple computers to share an Internet account.
WAN Service Type	This field is available only when you select Routing in the Mode field. Select the method of encapsulation used by your ISP. <ul style="list-style-type: none"> • PPP over Ethernet (PPPoE) - PPPoE (Point to Point Protocol over Ethernet) provides access control and billing functionality in a manner similar to dial-up services using PPP. Select this if you have a username and password for Internet access. • IP over Ethernet - In this type of Internet connection, IP packets are routed between the Ethernet interface and the WAN interface and then formatted so that they can be understood in a bridged environment.
ATM PVC Configuration	VPI (Virtual Path Identifier) and VCI (Virtual Channel Identifier) define a virtual circuit. This section is available only when you select ADSL in the Type field to configure an ATM layer-2 interface.
VPI	The valid range for the VPI is 0 to 255. Enter the VPI assigned to you.
VCI	The valid range for the VCI is 32 to 65535 (0 to 31 is reserved for local management of ATM traffic). Enter the VCI assigned to you.
DSL Link Type	The DSL link type is set to EoA (Ethernet over ATM) to have an Ethernet header in the packet, so that you can have multiple services/connections over one PVC. You can set each connection to have its own MAC address or all connections share one MAC address but use different VLAN IDs for different services. EoA supports IPoE, PPPoE and RFC1483/2684 bridging encapsulation methods.
Encapsulation Mode	The encapsulation method of multiplexing used by your is LLC/SNAP-BRIDGING . In LCC encapsulation, bridged PDUs are encapsulated by identifying the type of the bridged media in the SNAP header.

Table 7 Broadband Add/Edit: Routing- PPPoE (continued)

Label	DESCRIPTION
Service Category	<p>Select UBR Without PCR for applications that are non-time sensitive, such as e-mail.</p> <p>Select CBR (Constant Bit Rate) to specify fixed (always-on) bandwidth for voice or data traffic.</p> <p>Select Non Realtime VBR (non real-time Variable Bit Rate) for connections that do not require closely controlled delay and delay variation.</p> <p>Select Realtime VBR (real-time Variable Bit Rate) for applications with bursty connections that require closely controlled delay and delay variation.</p>
Peak Cell Rate	<p>Divide the DSL line rate (bps) by 424 (the size of an ATM cell) to find the Peak Cell Rate (PCR). This is the maximum rate at which the sender can send cells. Type the PCR here.</p> <p>This field is not available when you select UBR Without PCR.</p>
Sustainable Cell Rate	<p>The Sustain Cell Rate (SCR) sets the average cell rate (long-term) that can be transmitted. Type the SCR, which must be less than the PCR. Note that system default is 0 cells/sec.</p> <p>This field is available only when you select Non Realtime VBR or Realtime VBR.</p>
Maximum Burst Size	<p>Maximum Burst Size (MBS) refers to the maximum number of cells that can be sent at the peak rate. Type the MBS, which is less than 65535.</p> <p>This field is available only when you select Non Realtime VBR or Realtime VBR.</p>
VLAN	This section is available only when you select EtherWAN in the Type field.
Enable VLAN	Select this to add the VLAN tag (specified below) to the outgoing traffic through this connection.
Enter 802.1P Priority	<p>IEEE 802.1p defines up to 8 separate traffic types by inserting a tag into a MAC-layer frame that contains bits to define class of service.</p> <p>Type the IEEE 802.1p priority level (from 0 to 7) to add to traffic through this connection. The greater the number, the higher the priority level.</p>
Enter 802.1Q VLAN ID	Type the VLAN ID number (from 1 to 4094) for traffic through this connection.
PPP Information	This section is available only when you select Routing in the Mode field and PPPoE in the WAN Service Type field.
PPP User Name	Enter the user name exactly as your ISP assigned. If assigned a name in the form user@domain where domain identifies a service name, then enter both components exactly as given.
PPP Password	Enter the password associated with the user name above.
PPPoE Service Name	Type the name of your PPPoE service here.

Table 7 Broadband Add/Edit: Routing- PPPoE (continued)

Label	DESCRIPTION
Authentication Mode	<p>The ZyXEL Device supports PAP (Password Authentication Protocol) and CHAP (Challenge Handshake Authentication Protocol). CHAP is more secure than PAP; however, PAP is readily available on more platforms.</p> <p>Use the drop-down list box to select an authentication protocol for outgoing calls. Options are:</p> <p>AUTO: Your ZyXEL Device accepts either CHAP or PAP when requested by this remote node.</p> <p>CHAP: Your ZyXEL Device accepts CHAP only.</p> <p>PAP: Your ZyXEL Device accepts PAP only.</p> <p>MSCHAP: Your ZyXEL Device accepts MSCHAP only. MS-CHAP is the Microsoft version of the CHAP.</p>
Use Static IP Address	A static IP address is a fixed IP that your ISP gives you. A dynamic IP address is not fixed; the ISP assigns you a different one each time you connect to the Internet. Select this if you want to get a dynamic IP address from the ISP.
IP Address	Enter the static IP address provided by your ISP.
PPPoE Passthrough	<p>In addition to the ZyXEL Device's built-in PPPoE client, you can enable PPPoE pass through to allow up to ten hosts on the LAN to use PPPoE client software on their computers to connect to the ISP via the ZyXEL Device. Each host can have a separate account and a public WAN IP address.</p> <p>PPPoE pass through is an alternative to NAT for application where NAT is not appropriate.</p> <p>Disable PPPoE pass through if you do not need to allow hosts on the LAN to use PPPoE client software on their computers to connect to the ISP.</p>
Routing Feature	
NAT Enable	Select this option to activate NAT on this connection.
IGMP Proxy Enable	<p>Internet Group Multicast Protocol (IGMP) is a network-layer protocol used to establish membership in a Multicast group - it is not used to carry user data.</p> <p>Select this option to have the ZyXEL Device act as an IGMP proxy on this connection. This allows the ZyXEL Device to get subscribing information and maintain a joined member list for each multicast group. It can reduce multicast traffic significantly.</p>
Apply as Default Gateway	Select this option to have the ZyXEL Device use the WAN interface of this connection as the system default gateway.
DNS Server	The section is not available when you select Bridge in the WAN Service Type field.
Obtain DNS info Automatically	Select this to have the ZyXEL Device get the DNS server addresses from the ISP automatically.
Use the following Static DNS IP Address	Select this to have the ZyXEL Device use the DNS server addresses you configure manually.

Table 7 Broadband Add/Edit: Routing- PPPoE (continued)

Label	DESCRIPTION
Primary DNS Server	Enter the first DNS server address assigned by the ISP.
Secondary DNS Server	Enter the second DNS server address assigned by the ISP.
Apply	Click Apply to save your changes.
Back	Click Back to return to the previous screen.

5.2.1.2 Routing- IPoE

Click the **Add new WAN Interface** in the **Network Setting > Broadband** screen or the **Edit** icon next to the connection you want to configure. Select **Routing** as the encapsulation mode and **IPoE** as the WAN service type.

Broadband Add/Edit: Routing- IPoE

General	
Name :	<input type="text"/>
Type :	ADSL <input type="button" value="v"/>
Mode :	Routing <input type="button" value="v"/>
WANServiceType :	IP over Ethernet <input type="button" value="v"/>
ATM PVC Configuration	
VPI[0-255] :	<input type="text" value="8"/>
VCI[32-65535] :	<input type="text" value="34"/>
DSL Link Type :	EoA <input type="button" value="v"/>
Encapsulation Mode :	LLC/SNAP-BRIDGING <input type="button" value="v"/>
Service Category :	Non Realtime VBR <input type="button" value="v"/>
Peak Cell Rate[cells/s] :	<input type="text"/>
Sustainable Cell Rate[cells/s] :	<input type="text"/>
Maximum Burst Size [cells] :	<input type="text"/>
IP Address	
<input type="radio"/> Obtain an IP Address Automatically	
Enable DHCP Option 60 :	<input checked="" type="checkbox"/>
Vendor Class Identifier :	<input type="text"/>
<input checked="" type="radio"/> Static IP Address	
IP Address :	<input type="text" value="0.0.0.0"/>
SubnetMask :	<input type="text" value="0.0.0.0"/>
GatewayIPAddress :	<input type="text" value="0.0.0.0"/>
Routing Feature	
NAT Enable :	<input type="checkbox"/>
IGMP Proxy Enable :	<input type="checkbox"/>
Apply as Default Gateway :	<input type="checkbox"/>
DNS Server	
<input type="radio"/> Obtain DNS info Automatically	
<input checked="" type="radio"/> Use the following Static DNS IP Address	
Primary DNS Server :	<input type="text"/>
Secondary DNS Server :	<input type="text"/>
<input type="button" value="Apply"/> <input type="button" value="Back"/>	

The following table describes the fields in this screen.

Table 8 Broadband Add/Edit: Routing- IPoE

Label	DESCRIPTION
General	
Name	Enter a service name of the connection.

Table 8 Broadband Add/Edit: Routing- IPoE (continued)

Label	DESCRIPTION
Type	<p>Select an interface for which you want to configure here.</p> <p>ADSL: The ZyXEL Device uses the ADSL technology for data transmission over the DSL port.</p> <p>EtherWAN: The ZyXEL Device transmits data over the Ethernet WAN port. Select this if you have a DSL router or modem in your network already.</p>
Mode	Select Routing (default) from the drop-down list box if your ISP give you one IP address only and you want multiple computers to share an Internet account.
WAN Service Type	<p>This field is available only when you select Routing in the Mode field. Select the method of encapsulation used by your ISP.</p> <ul style="list-style-type: none"> • PPP over Ethernet (PPPoE) - PPPoE (Point to Point Protocol over Ethernet) provides access control and billing functionality in a manner similar to dial-up services using PPP. Select this if you have a username and password for Internet access. • IP over Ethernet - In this type of Internet connection, IP packets are routed between the Ethernet interface and the WAN interface and then formatted so that they can be understood in a bridged environment.
ATM PVC Configuration	<p>VPI (Virtual Path Identifier) and VCI (Virtual Channel Identifier) define a virtual circuit.</p> <p>This section is available only when you select ADSL in the Type field to configure an ATM layer-2 interface.</p>
VPI	The valid range for the VPI is 0 to 255. Enter the VPI assigned to you.
VCI	The valid range for the VCI is 32 to 65535 (0 to 31 is reserved for local management of ATM traffic). Enter the VCI assigned to you.
DSL Link Type	The DSL link type is set to EoA (Ethernet over ATM) to have an Ethernet header in the packet, so that you can have multiple services/connections over one PVC. You can set each connection to have its own MAC address or all connections share one MAC address but use different VLAN IDs for different services. EoA supports IPoE, PPPoE and RFC1483/2684 bridging encapsulation methods.
Encapsulation Mode	The encapsulation method of multiplexing used by your is LLC/SNAP-BRIDGING . In LCC encapsulation, bridged PDUs are encapsulated by identifying the type of the bridged media in the SNAP header.
Service Category	<p>Select UBR Without PCR for applications that are non-time sensitive, such as e-mail.</p> <p>Select CBR (Constant Bit Rate) to specify fixed (always-on) bandwidth for voice or data traffic.</p> <p>Select Non Realtime VBR (non real-time Variable Bit Rate) for connections that do not require closely controlled delay and delay variation.</p> <p>Select Realtime VBR (real-time Variable Bit Rate) for applications with bursty connections that require closely controlled delay and delay variation.</p>

Table 8 Broadband Add/Edit: Routing- IPoE (continued)

Label	DESCRIPTION
Peak Cell Rate	<p>Divide the DSL line rate (bps) by 424 (the size of an ATM cell) to find the Peak Cell Rate (PCR). This is the maximum rate at which the sender can send cells. Type the PCR here.</p> <p>This field is not available when you select UBR Without PCR.</p>
Sustainable Cell Rate	<p>The Sustain Cell Rate (SCR) sets the average cell rate (long-term) that can be transmitted. Type the SCR, which must be less than the PCR. Note that system default is 0 cells/sec.</p> <p>This field is available only when you select Non Realtime VBR or Realtime VBR.</p>
Maximum Burst Size	<p>Maximum Burst Size (MBS) refers to the maximum number of cells that can be sent at the peak rate. Type the MBS, which is less than 65535.</p> <p>This field is available only when you select Non Realtime VBR or Realtime VBR.</p>
VLAN	This section is available only when you select EtherWAN in the Type field.
Enable VLAN	Select this to add the VLAN tag (specified below) to the outgoing traffic through this connection.
Enter 802.1P Priority	<p>IEEE 802.1p defines up to 8 separate traffic types by inserting a tag into a MAC-layer frame that contains bits to define class of service.</p> <p>Type the IEEE 802.1p priority level (from 0 to 7) to add to traffic through this connection. The greater the number, the higher the priority level.</p>
Enter 802.1Q VLAN ID	Type the VLAN ID number (from 1 to 4094) for traffic through this connection.
IP Address	This section is available only when you select Routing in the Mode field and IPoE in the WAN Service Type field.
Obtain an IP Address Automatically	A static IP address is a fixed IP that your ISP gives you. A dynamic IP address is not fixed; the ISP assigns you a different one each time you connect to the Internet. Select this if you have a dynamic IP address.
Enable DHCP Option 60	Select this to identify the vendor and functionality of the ZyXEL Device in DHCP requests that the ZyXEL Device sends to a DHCP server when getting a WAN IP address.
Vendor Class Identifier	Enter the Vendor Class Identifier (Option 60), such as the type of the hardware or firmware.
Static IP Address	Select this option If the ISP assigned a fixed IP address.
IP Address	Enter the static IP address provided by your ISP.
Subnet Mask	Enter the subnet mask provided by your ISP.
Gateway IP Address	Enter the gateway IP address provided by your ISP.
Routing Feature	
NAT Enable	Select this option to activate NAT on this connection.

Table 8 Broadband Add/Edit: Routing- IPoE (continued)

Label	DESCRIPTION
IGMP Proxy Enable	Internet Group Multicast Protocol (IGMP) is a network-layer protocol used to establish membership in a Multicast group - it is not used to carry user data. Select this option to have the ZyXEL Device act as an IGMP proxy on this connection. This allows the ZyXEL Device to get subscribing information and maintain a joined member list for each multicast group. It can reduce multicast traffic significantly.
Apply as Default Gateway	Select this option to have the ZyXEL Device use the WAN interface of this connection as the system default gateway.
DNS Server	This is available only when you select Apply as Default Gateway in the Routing Feature field.
Obtain DNS info Automatically	Select this to have the ZyXEL Device get the DNS server addresses from the ISP automatically.
Use the following Static DNS IP Address	Select this to have the ZyXEL Device use the DNS server addresses you configure manually.
Primary DNS Server	Enter the first DNS server address assigned by the ISP.
Secondary DNS Server	Enter the second DNS server address assigned by the ISP.
Apply	Click Apply to save your changes.
Back	Click Back to return to the previous screen.

5.2.1.3 Bridge Mode

Click the **Add new WAN Interface** in the **Network Setting > Broadband** screen or the **Edit** icon next to the connection you want to configure. Select **Bridge** as the encapsulation mode. The screen differs according to the interface

type you select. If you select **ADSL** as the interface type, the following screen appears.

Figure 18 Broadband Add/Edit: Bridge (ADSL)

General

Name :

Type :

Mode :

Bridge Group

Select LAN/WLAN port(s) you wish to together with this WAN interface

Available LAN/WLAN Port(s) Bridged LAN/WLAN Port(s)

LAN1
LAN2
LAN3
LAN4
ZyXEL

Add >>

Remove <<

ATM PVC Configuration

VPI[0-255] :

VCI[32-65535] :

Encapsulation Mode :

Service Category :

Peak Cell Rate[cells/s] :

Sustainable Cell Rate[cells/s] :

Maximum Burst Size [cells] :

Apply Back

The following table describes the fields in this screen.

Table 9 Broadband Add/Edit: Bridge (ADSL)

Label	DESCRIPTION
General	
Name	Enter a service name of the connection.
Type	Select ADSL as the interface for which you want to configure here. The ZyXEL Device uses the ADSL technology for data transmission over the DSL port.
Mode	Select Bridge when your ISP provides you more than one IP address and you want the connected computers to get individual IP address from ISP's DHCP server directly. If you select Bridge , you cannot use routing functions, such as QoS, Firewall, DHCP server and NAT on traffic from the selected LAN port(s).

Table 9 Broadband Add/Edit: Bridge (ADSL) (continued)

Label	DESCRIPTION
Bridge Group	<p>Select the LAN/WLAN port(s) from which traffic will be forwarded to the WAN interface directly.</p> <p>Select a port from the Available LAN/WLAN Port(s) list and click Add >> to add it to the Bridged LAN/WLAN Port(s) list.</p> <p>If you want to remove a port from the Bridged LAN/WLAN Port(s) list, select it and click Remove <<.</p> <p>You cannot configure a QoS class for traffic from the LAN port which is selected here.</p>
ATM PVC Configuration	<p>VPI (Virtual Path Identifier) and VCI (Virtual Channel Identifier) define a virtual circuit.</p> <p>This section is available only when you select ADSL in the Type field to configure an ATM layer-2 interface.</p>
VPI	The valid range for the VPI is 0 to 255. Enter the VPI assigned to you.
VCI	The valid range for the VCI is 32 to 65535 (0 to 31 is reserved for local management of ATM traffic). Enter the VCI assigned to you.
DSL Link Type	The DSL link type is set to EoA (Ethernet over ATM) to have an Ethernet header in the packet, so that you can have multiple services/connections over one PVC. You can set each connection to have its own MAC address or all connections share one MAC address but use different VLAN IDs for different services. EoA supports IPoE, PPPoE and RFC1483/2684 bridging encapsulation methods.
Encapsulation Mode	The encapsulation method of multiplexing used by your is LLC/SNAP-BRIDGING . In LLC encapsulation, bridged PDUs are encapsulated by identifying the type of the bridged media in the SNAP header.
Service Category	<p>Select UBR Without PCR for applications that are non-time sensitive, such as e-mail.</p> <p>Select CBR (Constant Bit Rate) to specify fixed (always-on) bandwidth for voice or data traffic.</p> <p>Select Non Realtime VBR (non real-time Variable Bit Rate) for connections that do not require closely controlled delay and delay variation.</p> <p>Select Realtime VBR (real-time Variable Bit Rate) for applications with bursty connections that require closely controlled delay and delay variation.</p>
Peak Cell Rate	<p>Divide the DSL line rate (bps) by 424 (the size of an ATM cell) to find the Peak Cell Rate (PCR). This is the maximum rate at which the sender can send cells. Type the PCR here.</p> <p>This field is not available when you select UBR Without PCR.</p>
Sustainable Cell Rate	<p>The Sustain Cell Rate (SCR) sets the average cell rate (long-term) that can be transmitted. Type the SCR, which must be less than the PCR. Note that system default is 0 cells/sec.</p> <p>This field is available only when you select Non Realtime VBR or Realtime VBR.</p>

Table 9 Broadband Add/Edit: Bridge (ADSL) (continued)

Label	DESCRIPTION
Maximum Burst Size	Maximum Burst Size (MBS) refers to the maximum number of cells that can be sent at the peak rate. Type the MBS, which is less than 65535. This field is available only when you select Non Realtime VBR or Realtime VBR .
Apply	Click Apply to save your changes.
Back	Click Back to return to the previous screen.

If you select EtherWAN as the interface type, the following screen appears.

Figure 19 Broadband Add/Edit: Bridge (Ethernet)

General

Name :

Type :

Mode :

VLAN

Enter 802.1P Priority [0-7] :

Enable VLAN ID :

Enter 802.1Q VLAN ID [1-4094] : (3900 ~ 3905 are reserved.)

Bridge Group

Select LAN/WLAN port(s) you wish to together with this WAN interface

Available LAN/WLAN Port(s) Bridged LAN/WLAN Port(s)

LAN1 Add >>
LAN2 Remove <<
LAN3
LAN4
ZyXEL

Apply Back

The following table describes the fields in this screen.

Table 10 Broadband Add/Edit: Bridge (Ethernet)

Label	DESCRIPTION
General	
Name	Enter a service name of the connection.
Type	Select EtherWAN as the interface for which you want to configure The ZyXEL Device transmits data over the Ethernet WAN port. Select this if you have a DSL router or modem in your network already.
Mode	Select Bridge when your ISP provides you more than one IP address and you want the connected computers to get individual IP address from ISP's DHCP server directly. If you select Bridge , you cannot use routing functions, such as QoS, Firewall, DHCP server and NAT on traffic from the selected LAN port(s).
VLAN	This section is available only when you select EtherWAN in the Type field.

Table 10 Broadband Add/Edit: Bridge (Ethernet) (continued)

Label	DESCRIPTION
Enable VLAN	Select this to add the VLAN Tag (specified below) to the outgoing traffic through this connection.
Enter 802.1P Priority	IEEE 802.1p defines up to 8 separate traffic types by inserting a tag into a MAC-layer frame that contains bits to define class of service. Type the IEEE 802.1p priority level (from 0 to 7) to add to traffic through this connection. The greater the number, the higher the priority level.
Enter 802.1Q VLAN ID	Type the VLAN ID number (from 1 to 4094) for traffic through this connection.
Bridge Group	Select the LAN/WLAN port(s) from which traffic will be forwarded to the WAN interface directly. Select a port from the Available LAN/WLAN Port(s) list and click Add >> to add it to the Bridged LAN/WLAN Port(s) list. If you want to remove a port from the Bridged LAN/WLAN Port(s) list, select it and click Remove << . You cannot configure a QoS class for traffic from the LAN port which is selected here.
Apply	Click Apply to save your changes.
Back	Click Back to return to the previous screen.

5.3 The 3G Backup Screen

Use this screen to configure your 3G settings. Click **Broadband > 3G Backup**.

At the time of writing, the 3G card you can use in the ZyXEL Device is Huawei E220.

Note: The actual data rate you obtain varies depending the 3G card you use, the signal strength to the service provider's base station, and so on.

If the signal strength of a 3G network is too low, the 3G card may switch to an available 2.5G or 2.75G network. Refer to [Section 5.4 on page 114](#) for a comparison between 2G, 2.5G, 2.75G and 3G wireless technologies.

Figure 20 Broadband > 3G Backup

The following table describes the labels in this screen.

Table 11 Broadband > 3G Backup

LABEL	DESCRIPTION
3G Backup	Select Enable 3G Backup to have the ZyXEL Device use the 3G connection as your WAN or a backup when the wired WAN connection fails.
Card Description	This field displays the manufacturer and model name of your 3G card if you inserted one in the ZyXEL Device. Otherwise, it displays N/A .
Username	Type the user name (of up to 70 ASCII printable characters) given to you by your service provider.
Password	Type the password (of up to 70 ASCII printable characters) associated with the user name above.
PIN	A PIN (Personal Identification Number) code is a key to a 3G card. Without the PIN code, you cannot use the 3G card. If your ISP enabled PIN code authentication, enter the 4-digit PIN code (0000 for example) provided by your ISP. If you enter the PIN code incorrectly, the 3G card may be blocked by your ISP and you cannot use the account to access the Internet. If your ISP disabled PIN code authentication, leave this field blank.

Table 11 Broadband > 3G Backup (continued)

LABEL	DESCRIPTION
Dial String	Enter the phone number (dial string) used to dial up a connection to your service provider's base station. Your ISP should provide the phone number. For example, *99# is the dial string to establish a GPRS or 3G connection in Taiwan.
APN Code	Enter the APN (Access Point Name) provided by your service provider. Connections with different APNs may provide different services (such as Internet access or MMS (Multi-Media Messaging Service)) and charge method. You can enter up to 31 ASCII printable characters. Spaces are allowed.
Connection	Select Nailed-UP if you do not want the connection to time out. Select On-Demand if you do not want the connection up all the time and specify an idle time-out in the Max Idle Timeout field.
Max Idle Timeout	This value specifies the time in minutes that elapses before the ZyXEL Device automatically disconnects from the ISP.
Obtain an IP Address Automatically	Select this option If your ISP did not assign you a fixed IP address.
Use the following static IP address	Select this option If the ISP assigned a fixed IP address.
IP Address	Enter your WAN IP address in this field if you selected Use the following static IP address .
Obtain DNS info dynamically	Select this to have the ZyXEL Device get the DNS server addresses from the ISP automatically.
Use the following static DNS IP address	Select this to have the ZyXEL Device use the DNS server addresses you configure manually.
Primary DNS server	Enter the first DNS server address assigned by the ISP.
Secondary DNS server	Enter the second DNS server address assigned by the ISP.
Apply	Click Apply to save your changes back to the ZyXEL Device.
Cancel	Click Cancel to return to the previous configuration.

5.4 Technical Reference

The following section contains additional technical information about the ZyXEL Device features described in this chapter.

Encapsulation

Be sure to use the encapsulation method required by your ISP. The ZyXEL Device can work in bridge mode or routing mode. When the ZyXEL Device is in routing mode, it supports the following methods.

IP over Ethernet

IP over Ethernet (IPoE) is an alternative to PPPoE. IP packets are being delivered across an Ethernet network, without using PPP encapsulation. They are routed between the Ethernet interface and the WAN interface and then formatted so that they can be understood in a bridged environment. For instance, it encapsulates routed Ethernet frames into bridged Ethernet cells.

PPP over Ethernet

Point-to-Point Protocol over Ethernet (PPPoE) provides access control and billing functionality in a manner similar to dial-up services using PPP. PPPoE is an IETF standard (RFC 2516) specifying how a personal computer (PC) interacts with a broadband modem (DSL, cable, wireless, etc.) connection.

For the service provider, PPPoE offers an access and authentication method that works with existing access control systems (for example RADIUS).

One of the benefits of PPPoE is the ability to let you access one of multiple network services, a function known as dynamic service selection. This enables the service provider to easily create and offer new IP services for individuals.

Operationally, PPPoE saves significant effort for both you and the ISP or carrier, as it requires no specific configuration of the broadband modem at the customer site.

By implementing PPPoE directly on the ZyXEL Device (rather than individual computers), the computers on the LAN do not need PPPoE software installed, since the ZyXEL Device does that part of the task. Furthermore, with NAT, all of the LANs' computers will have access.

RFC 1483

RFC 1483 describes two methods for Multiprotocol Encapsulation over ATM Adaptation Layer 5 (AAL5). The first method allows multiplexing of multiple protocols over a single ATM virtual circuit (LLC-based multiplexing) and the second method assumes that each protocol is carried over a separate ATM virtual circuit (VC-based multiplexing). Please refer to RFC 1483 for more detailed information.

Multiplexing

There are two conventions to identify what protocols the virtual circuit (VC) is carrying. Be sure to use the multiplexing method required by your ISP.

VC-based Multiplexing

In this case, by prior mutual agreement, each protocol is assigned to a specific virtual circuit; for example, VC1 carries IP, etc. VC-based multiplexing may be dominant in environments where dynamic creation of large numbers of ATM VCs is fast and economical.

LLC-based Multiplexing

In this case one VC carries multiple protocols with protocol identifying information being contained in each packet header. Despite the extra bandwidth and processing overhead, this method may be advantageous if it is not practical to have a separate VC for each carried protocol, for example, if charging heavily depends on the number of simultaneous VCs.

Traffic Shaping

Traffic Shaping is an agreement between the carrier and the subscriber to regulate the average rate and fluctuations of data transmission over an ATM network. This agreement helps eliminate congestion, which is important for transmission of real time data such as audio and video connections.

Peak Cell Rate (PCR) is the maximum rate at which the sender can send cells. This parameter may be lower (but not higher) than the maximum line speed. 1 ATM cell is 53 bytes (424 bits), so a maximum speed of 832Kbps gives a maximum PCR of 1962 cells/sec. This rate is not guaranteed because it is dependent on the line speed.

Sustained Cell Rate (SCR) is the mean cell rate of each bursty traffic source. It specifies the maximum average rate at which cells can be sent over the virtual connection. SCR may not be greater than the PCR.

Maximum Burst Size (MBS) is the maximum number of cells that can be sent at the PCR. After MBS is reached, cell rates fall below SCR until cell rate averages to the SCR again. At this time, more cells (up to the MBS) can be sent at the PCR again.

If the PCR, SCR or MBS is set to the default of "0", the system will assign a maximum value that correlates to your upstream line rate.

The following figure illustrates the relationship between PCR, SCR and MBS.

Figure 21 Example of Traffic Shaping

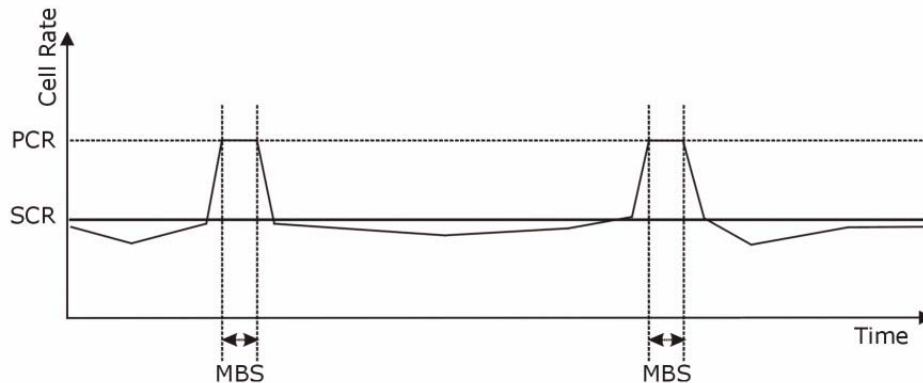

ATM Traffic Classes

These are the basic ATM traffic classes defined by the ATM Forum Traffic Management 4.0 Specification.

Constant Bit Rate (CBR)

Constant Bit Rate (CBR) provides fixed bandwidth that is always available even if no data is being sent. CBR traffic is generally time-sensitive (doesn't tolerate delay). CBR is used for connections that continuously require a specific amount of bandwidth. A PCR is specified and if traffic exceeds this rate, cells may be dropped. Examples of connections that need CBR would be high-resolution video and voice.

Variable Bit Rate (VBR)

The Variable Bit Rate (VBR) ATM traffic class is used with bursty connections. Connections that use the Variable Bit Rate (VBR) traffic class can be grouped into real time (VBR-RT) or non-real time (VBR-nRT) connections.

The VBR-RT (real-time Variable Bit Rate) type is used with bursty connections that require closely controlled delay and delay variation. It also provides a fixed amount of bandwidth (a PCR is specified) but is only available when data is being sent. An example of an VBR-RT connection would be video conferencing. Video conferencing requires real-time data transfers and the bandwidth requirement varies in proportion to the video image's changing dynamics.

The VBR-nRT (non real-time Variable Bit Rate) type is used with bursty connections that do not require closely controlled delay and delay variation. It is commonly used for "bursty" traffic typical on LANs. PCR and MBS define the burst levels, SCR defines the minimum level. An example of an VBR-nRT connection would be non-time sensitive data file transfers.

Unspecified Bit Rate (UBR)

The Unspecified Bit Rate (UBR) ATM traffic class is for bursty data transfers. However, UBR doesn't guarantee any bandwidth and only delivers traffic when the network has spare bandwidth. An example application is background file transfer.

IP Address Assignment

A static IP is a fixed IP that your ISP gives you. A dynamic IP is not fixed; the ISP assigns you a different one each time. The Single User Account feature can be enabled or disabled if you have either a dynamic or static IP. However the encapsulation method assigned influences your choices for IP address and default gateway.

Introduction to VLANs

A Virtual Local Area Network (VLAN) allows a physical network to be partitioned into multiple logical networks. Devices on a logical network belong to one group. A device can belong to more than one group. With VLAN, a device cannot directly talk to or hear from devices that are not in the same group(s); the traffic must first go through a router.

In Multi-Tenant Unit (MTU) applications, VLAN is vital in providing isolation and security among the subscribers. When properly configured, VLAN prevents one subscriber from accessing the network resources of another on the same LAN, thus a user will not see the printers and hard disks of another user in the same building.

VLAN also increases network performance by limiting broadcasts to a smaller and more manageable logical broadcast domain. In traditional switched environments, all broadcast packets go to each and every individual port. With VLAN, all broadcasts are confined to a specific broadcast domain.

Introduction to IEEE 802.1Q Tagged VLAN

A tagged VLAN uses an explicit tag (VLAN ID) in the MAC header to identify the VLAN membership of a frame across bridges - they are not confined to the switch on which they were created. The VLANs can be created statically by hand or dynamically through GVRP. The VLAN ID associates a frame with a specific VLAN and provides the information that switches need to process the frame across the network. A tagged frame is four bytes longer than an untagged frame and contains two bytes of TPID (Tag Protocol Identifier), residing within the type/length field of the Ethernet frame) and two bytes of TCI (Tag Control Information), starts after the source address field of the Ethernet frame).

The CFI (Canonical Format Indicator) is a single-bit flag, always set to zero for Ethernet switches. If a frame received at an Ethernet port has a CFI set to 1, then that frame should not be forwarded as it is to an untagged port. The remaining twelve bits define the VLAN ID, giving a possible maximum number of 4,096 VLANs. Note that user priority and VLAN ID are independent of each other. A frame with VID (VLAN Identifier) of null (0) is called a priority frame, meaning that only the priority level is significant and the default VID of the ingress port is given as the VID of the frame. Of the 4096 possible VIDs, a VID of 0 is used to identify priority frames and value 4095 (FFF) is reserved, so the maximum possible VLAN configurations are 4,094.

TPID	User Priority	CFI	VLAN ID
2 Bytes	3 Bits	1 Bit	12 Bits

Multicast

IP packets are transmitted in either one of two ways - Unicast (1 sender - 1 recipient) or Broadcast (1 sender - everybody on the network). Multicast delivers IP packets to a group of hosts on the network - not everybody and not just 1.

Internet Group Multicast Protocol (IGMP) is a network-layer protocol used to establish membership in a Multicast group - it is not used to carry user data. IGMP version 2 (RFC 2236) is an improvement over version 1 (RFC 1112) but IGMP version 1 is still in wide use. If you would like to read more detailed information about interoperability between IGMP version 2 and version 1, please see sections 4 and 5 of RFC 2236. The class D IP address is used to identify host groups and can be in the range 224.0.0.0 to 239.255.255.255. The address 224.0.0.0 is not assigned to any group and is used by IP multicast computers. The address 224.0.0.1 is used for query messages and is assigned to the permanent group of all IP hosts (including gateways). All hosts must join the 224.0.0.1 group in order to participate in IGMP. The address 224.0.0.2 is assigned to the multicast routers group.

At start up, the ZyXEL Device queries all directly connected networks to gather group membership. After that, the ZyXEL Device periodically updates this information.

DNS Server Address Assignment

Use Domain Name System (DNS) to map a domain name to its corresponding IP address and vice versa, for instance, the IP address of `www.zyxel.com` is 204.217.0.2. The DNS server is extremely important because without it, you must know the IP address of a computer before you can access it.

The ZyXEL Device can get the DNS server addresses in the following ways.

- 1 The ISP tells you the DNS server addresses, usually in the form of an information sheet, when you sign up. If your ISP gives you DNS server addresses, manually enter them in the DNS server fields.
- 2 If your ISP dynamically assigns the DNS server IP addresses (along with the ZyXEL Device's WAN IP address), set the DNS server fields to get the DNS server address from the ISP.

3G Comparison Table

See the following table for a comparison between 2G, 2.5G, 2.75G and 3G wireless technologies.

Table 12 2G, 2.5G, 2.75G, 3G and 3.5G Wireless Technologies

NAME	TYPE	MOBILE PHONE AND DATA STANDARDS		DATA SPEED
		GSM-BASED	CDMA-BASED	
2G	Circuit-switched	GSM (Global System for Mobile Communications), Personal Handy-phone System (PHS), etc.	Interim Standard 95 (IS-95), the first CDMA-based digital cellular standard pioneered by Qualcomm. The brand name for IS-95 is cdmaOne. IS-95 is also known as TIA-EIA-95.	
2.5G	Packet-switched	GPRS (General Packet Radio Services), High-Speed Circuit-Switched Data (HSCSD), etc.	CDMA2000 is a hybrid 2.5G / 3G protocol of mobile telecommunications standards that use CDMA, a multiple access scheme for digital radio.	
2.75G	Packet-switched	Enhanced Data rates for GSM Evolution (EDGE), Enhanced GPRS (EGPRS), etc.	CDMA2000 1xRTT (1 times Radio Transmission Technology) is the core CDMA2000 wireless air interface standard. It is also known as 1x, 1xRTT, or IS-2000 and considered to be a 2.5G or 2.75G technology.	
3G	Packet-switched	UMTS (Universal Mobile Telecommunications System), a third-generation (3G) wireless standard defined in ITU ^A specification, is sometimes marketed as 3GSM. The UMTS uses GSM infrastructures and W-CDMA (Wideband Code Division Multiple Access) as the air interface.	CDMA2000 EV-DO (Evolution-Data Optimized, originally 1x Evolution-Data Only), also referred to as EV-DO, EVDO, or just EV, is an evolution of CDMA2000 1xRTT and enables high-speed wireless connectivity. It is also denoted as IS-856 or High Data Rate (HDR).	
3.5G	Packet-switched	HSDPA (High-Speed Downlink Packet Access) is a mobile telephony protocol, used for UMTS-based 3G networks and allows for higher data transfer speeds.		

A. The International Telecommunication Union (ITU) is an international organization within which governments and the private sector coordinate global telecom networks and services.

Wireless

6.1 Overview

This chapter describes the ZyXEL Device's **Network Setting > Wireless** screens. Use these screens to set up your ZyXEL Device's wireless connection.

6.1.1 What You Can Do in this Chapter

- Use the **General** screen to enable the Wireless LAN, enter the SSID and select the wireless security mode ([Section 6.2 on page 125](#)).
- Use the **More AP** screen to set up multiple wireless networks on your ZyXEL Device ([Section 6.3 on page 133](#)).
- Use the **WPS** screen to enable or disable WPS, view or generate a security PIN (Personal Identification Number) ([Section 6.4 on page 135](#)).
- Use the **WMM** screen to enable Wi-Fi MultiMedia (WMM) to ensure quality of service in wireless networks for multimedia applications ([Section 6.5 on page 137](#)).
- Use the **Scheduling** screen to schedule a time period for the wireless LAN to operate each day ([Section 6.6 on page 139](#)).

You don't necessarily need to use all these screens to set up your wireless connection. For example, you may just want to set up a network name, a wireless radio channel and some security in the **General** screen.

6.1.2 Wireless Network Overview

Wireless networks consist of wireless clients, access points and bridges.

- A wireless client is a radio connected to a user's computer.
- An access point is a radio with a wired connection to a network, which can connect with numerous wireless clients and let them access the network.
- A bridge is a radio that relays communications between access points and wireless clients, extending a network's range.

Traditionally, a wireless network operates in one of two ways.

- An “infrastructure” type of network has one or more access points and one or more wireless clients. The wireless clients connect to the access points.
- An “ad-hoc” type of network is one in which there is no access point. Wireless clients connect to one another in order to exchange information.

The following figure provides an example of a wireless network.

Figure 22 Example of a Wireless Network

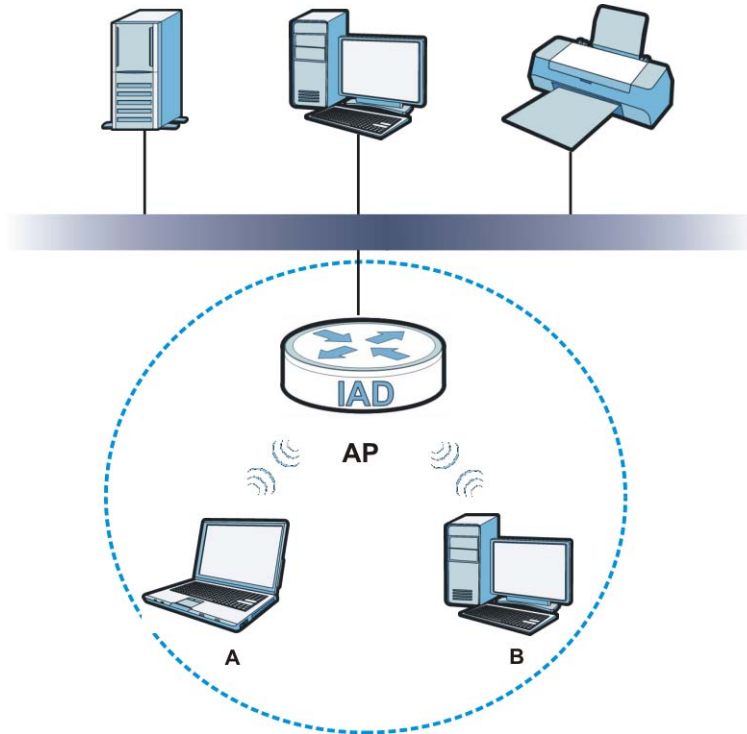

The wireless network is the part in the blue circle. In this wireless network, devices **A** and **B** use the access point (**AP**) to interact with the other devices (such as the printer) or with the Internet. Your ZyXEL Device is the AP.

Every wireless network must follow these basic guidelines.

- Every device in the same wireless network must use the same SSID.
The SSID is the name of the wireless network. It stands for Service Set Identifier.
- If two wireless networks overlap, they should use a different channel.
Like radio stations or television channels, each wireless network uses a specific channel, or frequency, to send and receive information.
- Every device in the same wireless network must use security compatible with the AP.
- Security stops unauthorized devices from using the wireless network. It can also protect the information that is sent in the wireless network.

Radio Channels

In the radio spectrum, there are certain frequency bands allocated for unlicensed, civilian use. For the purposes of wireless networking, these bands are divided into numerous channels. This allows a variety of networks to exist in the same place without interfering with one another. When you create a network, you must select a channel to use.

Since the available unlicensed spectrum varies from one country to another, the number of available channels also varies.

6.1.3 Before You Begin

Before you start using these screens, ask yourself the following questions. See [Section 6.7 on page 139](#) if some of the terms used here do not make sense to you.

- What wireless standards do the other wireless devices support (IEEE 802.11g, for example)? What is the most appropriate standard to use?
- What security options do the other wireless devices support (WPA-PSK, for example)? What is the best one to use?
- Do the other wireless devices support WPS (Wi-Fi Protected Setup)? If so, you can set up a well-secured network very easily.

Even if some of your devices support WPS and some do not, you can use WPS to set up your network and then add the non-WPS devices manually, although this is somewhat more complicated to do.

- What advanced options do you want to configure, if any? If you want to configure advanced options, ensure that you know precisely what you want to do. If you do not want to configure advanced options, leave them alone.

6.2 The Wireless General Screen

Use this screen to enable the Wireless LAN, enter the SSID and select the wireless security mode.

Note: If you are configuring the ZyXEL Device from a computer connected to the wireless LAN and you change the ZyXEL Device's SSID or security settings, you will lose your wireless connection when you press **Apply** to confirm. You must then change the wireless settings of your computer to match the ZyXEL Device's new settings.

Click **Network Setting > Wireless** to open the **General** screen.

Figure 23 Network Setting > Wireless > General

Wireless Network Setup

Wireless : Enable Wireless LAN

Wireless Network Settings

Wireless Network Name(SSID):

Hide SSID

BSSID : 40:4a:03:ff:5b:e4

Mode Select :

Channel Selection :

Operating Channel 1

Security Level

No Security Basic More Secure (Recommended)

The following table describes the labels in this screen.

Table 13 Network > Wireless LAN > General

LABEL	DESCRIPTION
Wireless Network Setup	
Wireless	Select the Enable Wireless LAN check box to activate the wireless LAN.
Wireless Network Settings	
Wireless Network Name (SSID)	The SSID (Service Set IDentity) identifies the service set with which a wireless device is associated. Wireless devices associating to the access point (AP) must have the same SSID. Enter a descriptive name (up to 32 English keyboard characters) for the wireless LAN.
Hide SSID	Select this check box to hide the SSID in the outgoing beacon frame so a station cannot obtain the SSID through scanning using a site survey tool.
BSSID	This shows the MAC address of the wireless interface on the ZyXEL Device when wireless LAN is enabled.

Table 13 Network > Wireless LAN > General (continued)

LABEL	DESCRIPTION
Mode Select	<p>This makes sure that only compliant WLAN devices can associate with the ZyXEL Device.</p> <p>Select 802.11b/g/n to allow IEEE802.11b, IEEE802.11g and IEEE802.11n compliant WLAN devices to associate with the ZyXEL Device. The transmission rate of your ZyXEL Device might be reduced.</p> <p>Select 802.11b/g to allow both IEEE802.11b and IEEE802.11g compliant WLAN devices to associate with the ZyXEL Device. The transmission rate of your ZyXEL Device might be reduced.</p> <p>Select 802.11g Only to allow only IEEE 802.11g compliant WLAN devices to associate with the ZyXEL Device. Select 802.11n only in 2.4G band to allow only IEEE 802.11n compliant WLAN devices with the same frequency range (2.4 GHz) to associate with the ZyXEL Device.</p> <p>Select 802.11n only in 5G band to allow only IEEE 802.11n compliant WLAN devices with the same frequency range (5 GHz) to associate with the ZyXEL Device.</p>
Channel Selection	<p>Set the channel depending on your particular region.</p> <p>Select a channel or use Auto to have the ZyXEL Device automatically determine a channel to use. If you are having problems with wireless interference, changing the channel may help. Try to use a channel that is as many channels away from any channels used by neighboring APs as possible. The channel number which the ZyXEL Device is currently using then displays in the Operating Channel field.</p>
Scan	<p>Click this button to have the ZyXEL Device immediately scan for and select a channel (which is not used by another device) whenever the device reboots or the wireless setting is changed.</p>
Operating Channel	<p>This is the channel currently being used by your AP.</p>
Security Level	
Security Mode	<p>Select Basic or More Secure to add security on this wireless network. The wireless clients which want to associate to this network must have same wireless security settings as the ZyXEL Device. When you select to use a security, additional options appears in this screen.</p> <p>Or you can select No Security to allow any client to associate this network without any data encryption or authentication.</p> <p>See the following sections for more details about wireless security modes.</p>
Apply	<p>Click Apply to save your changes back to the ZyXEL Device.</p>
Cancel	<p>Click Cancel to restore your previously saved settings.</p>

6.2.1 No Security

Select **No Security** to allow wireless stations to communicate with the access points without any data encryption or authentication.

Note: If you do not enable any wireless security on your ZyXEL Device, your network is accessible to any wireless networking device that is within range.

Figure 24 Wireless > General: No Security

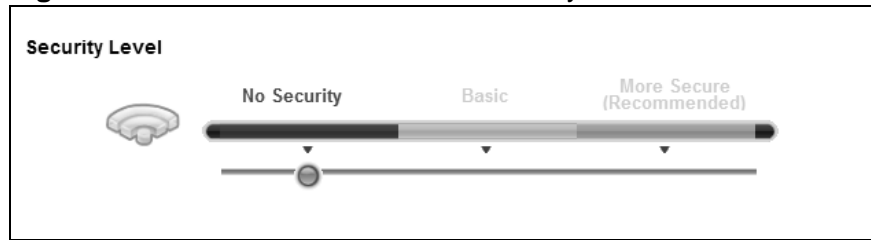

The following table describes the labels in this screen.

Table 14 Wireless > General: No Security

LABEL	DESCRIPTION
Security Level	Choose No Security from the sliding bar.

6.2.2 Basic (Static WEP/Shared WEP Encryption)

WEP encryption scrambles the data transmitted between the wireless stations and the access points (AP) to keep network communications private. Both the wireless stations and the access points must use the same WEP key.

There are two types of WEP authentication namely, Open System (**Static WEP**) and Shared Key (**Shared WEP**).

Open system is implemented for ease-of-use and when security is not an issue. The wireless station and the AP or peer computer do not share a secret key. Thus the wireless stations can associate with any AP or peer computer and listen to any transmitted data that is not encrypted.

Shared key mode involves a shared secret key to authenticate the wireless station to the AP or peer computer. This requires you to enable the wireless LAN security and use same settings on both the wireless station and the AP or peer computer.

In order to configure and enable WEP encryption, click **Network Settings > Wireless** to display the **General** screen. Select **Basic** as the security level. Then select **Static WEP** or **Shared WEP** from the **Security Mode** list.

Figure 25 Wireless > General: Basic (Static WEP/Shared WEP)

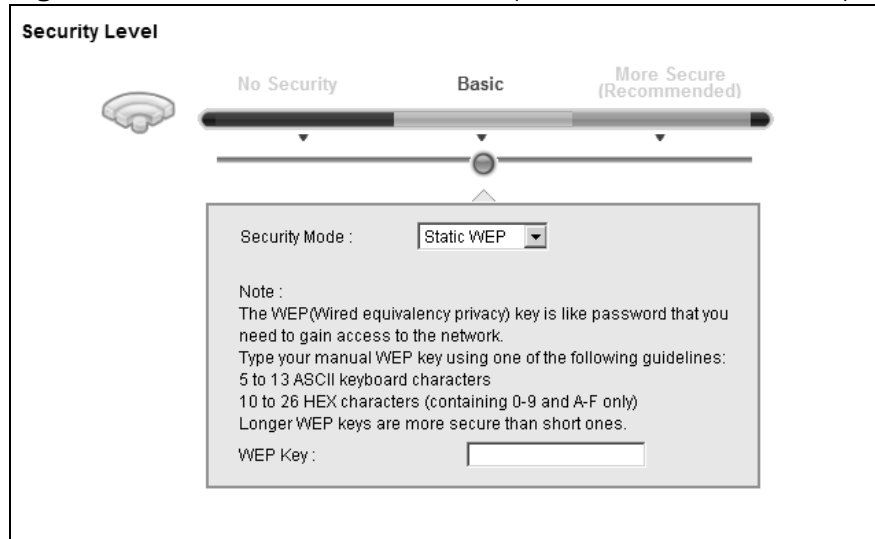

The following table describes the labels in this screen.

Table 15 Wireless > General: Basic (Static WEP/Shared WEP)

LABEL	DESCRIPTION
Security Mode	<p>Choose Static WEP or Shared WEP from the drop-down list box.</p> <ul style="list-style-type: none"> Select Static WEP to have the ZyXEL Device allow association with wireless clients that use Open System mode. Data transfer is encrypted as long as the wireless client has the correct WEP key for encryption. The ZyXEL Device authenticates wireless clients using Shared Key mode that have the correct WEP key. Select Shared WEP to have the ZyXEL Device authenticate only those wireless clients that use Shared Key mode and have the correct WEP key.
WEP Key	<p>Enter a WEP key that will be used to encrypt data. Both the ZyXEL Device and the wireless stations must use the same WEP key for data transmission.</p> <p>If you want to manually set the WEP key, enter any 5 or 13 characters (ASCII string) or 10 or 26 hexadecimal characters ("0-9", "A-F") for a 64-bit or 128-bit WEP key respectively.</p>

6.2.3 More Secure (WPA(2)-PSK)

The WPA-PSK security mode provides both improved data encryption and user authentication over WEP. Using a Pre-Shared Key (PSK), both the ZyXEL Device and the connecting client share a common password in order to validate the connection. This type of encryption, while robust, is not as strong as WPA, WPA2 or even WPA2-PSK. The WPA2-PSK security mode is a newer, more robust version of the WPA encryption standard. It offers slightly better security, although the use of PSK makes it less robust than it could be.

Click **Network Settings > Wireless** to display the **General** screen. Select **More Secure** as the security level. Then select **WPA-PSK** or **WPA2-PSK** from the **Security Mode** list.

Figure 26 Wireless > General: More Secure: WPA(2)-PSK

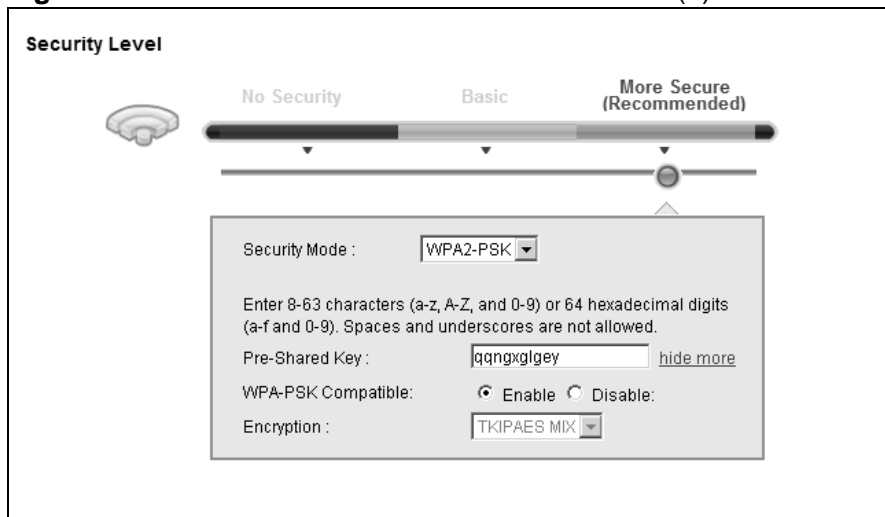

The following table describes the labels in this screen.

Table 16 Wireless > General: WPA(2)-PSK

LABEL	DESCRIPTION
Security Level	Select More Secure to enable WPA(2)-PSK data encryption.
Security Mode	Select WPA-PSK or WPA2-PSK from the drop-down list box.
Pre-Shared Key	The encryption mechanisms used for WPA/WPA2 and WPA-PSK/WPA2-PSK are the same. The only difference between the two is that WPA-PSK/WPA2-PSK uses a simple common password, instead of user-specific credentials. Type a pre-shared key from 8 to 63 case-sensitive ASCII characters or 64 hexadecimal digits.
more.../hide more	Click more... to show more fields in this section. Click hide more to hide them.

Table 16 Wireless > General: WPA(2)-PSK (continued)

LABEL	DESCRIPTION
WPA-PSK Compatible	<p>This field appears when you choose WPA-PSK2 as the Security Mode.</p> <p>Check this field to allow wireless devices using WPA-PSK security mode to connect to your ZyXEL Device. The ZyXEL Device supports WPA-PSK and WPA2-PSK simultaneously.</p>
Encryption	<p>If the security mode is WPA-PSK, the encryption mode is set to TKIP to enable Temporal Key Integrity Protocol (TKIP) security on your wireless network.</p> <p>If the security mode is WPA-PSK2 and WPA-PSK Compatible is disabled, the encryption mode is set to AES to enable Advanced Encryption System (AES) security on your wireless network. AES provides superior security to TKIP.</p> <p>If the security mode is WPA-PSK2 and WPA-PSK Compatible is enabled, the encryption mode is set to TKIPAES MIX to allow both TKIP and AES types of security in your wireless network.</p>

6.2.4 WPA(2) Authentication

The WPA2 security mode is currently the most robust form of encryption for wireless networks. It requires a RADIUS server to authenticate user credentials and is a full implementation the security protocol. Use this security option for maximum protection of your network. However, it is the least backwards compatible with older devices.

The WPA security mode is a security subset of WPA2. It requires the presence of a RADIUS server on your network in order to validate user credentials. This encryption standard is slightly older than WPA2 and therefore is more compatible with older devices.

Click **Network Settings** > **Wireless** to display the **General** screen. Select **More Secure** as the security level. Then select **WPA** or **WPA2** from the **Security Mode** list.

Figure 27 Wireless > General: More Secure: WPA(2)

The following table describes the labels in this screen.

Table 17 Wireless > General: More Secure: WPA(2)

LABEL	DESCRIPTION
Security Level	Select More Secure to enable WPA(2)-PSK data encryption.
Security Mode	Choose WPA or WPA2 from the drop-down list box.
Authentication Server	
IP Address	Enter the IP address of the external authentication server in dotted decimal notation.
Port Number	Enter the port number of the external authentication server. The default port number is 1812 . You need not change this value unless your network administrator instructs you to do so with additional information.
Shared Secret	Enter a password (up to 31 alphanumeric characters) as the key to be shared between the external authentication server and the ZyXEL Device. The key must be the same on the external authentication server and your ZyXEL Device. The key is not sent over the network.
more.../hide more	Click more... to show more fields in this section. Click hide more to hide them.
WPA Compatible	This field is only available for WPA2. Select this if you want the ZyXEL Device to support WPA and WPA2 simultaneously.
Group Key Update Timer	The Group Key Update Timer is the rate at which the RADIUS server sends a new group key out to all clients.

Table 17 Wireless > General: More Secure: WPA(2) (continued)

LABEL	DESCRIPTION
Encryption	<p>If the security mode is WPA, the encryption mode is set to TKIP to enable Temporal Key Integrity Protocol (TKIP) security on your wireless network.</p> <p>If the security mode is WPA2, the encryption mode is set to AES to enable Advanced Encryption System (AES) security on your wireless network. AES provides superior security to TKIP.</p>
ReKey Method	<ul style="list-style-type: none"> • The ZyXEL Device can automatically disconnect a wireless station from the wired network after a period of inactivity or after a certain number of packets have been processed. The wireless station needs to enter the username and password again before access to the wired network is allowed. Select TIME to have the ZyXEL Device automatically disconnects a wireless station from the wired network after a period of inactivity. • Select PKT to have the ZyXEL Device automatically disconnects a wireless station from the wired network after a certain number of packets have been processed. • Select NONE if you do not want the connection between the ZyXEL Device and a wireless station to time out.







6.3 The More AP Screen

The ZyXEL Device can broadcast up to four wireless network names at the same time. This means that users can connect to the ZyXEL Device using different SSIDs. You can secure the connection on each SSID profile so that wireless clients connecting to the ZyXEL Device using different SSIDs cannot communicate with each other.

This screen allows you to enable and configure multiple Basic Service Sets (BSSs) on the ZyXEL Device.

Click **Network Settings > Wireless > More AP**. The following screen displays.

Figure 28 Network Settings > Wireless > More AP

#	Active	SSID	Security	Modify
2		ZyXEL2	WPA2-PSK	
3		ZyXEL3	WPA2-PSK	
4		ZyXEL4	WPA2-PSK	

The following table describes the labels in this screen.

Table 18 Network Settings > Wireless > More AP

LABEL	DESCRIPTION
#	This is the index number of the entry.
Active	This field indicates whether this SSID is active. A yellow bulb signifies that this SSID is active. A gray bulb signifies that this SSID is not active.
SSID	An SSID profile is the set of parameters relating to one of the ZyXEL Device's BSSs. The SSID (Service Set Identifier) identifies the Service Set with which a wireless device is associated. This field displays the name of the wireless profile on the network. When a wireless client scans for an AP to associate with, this is the name that is broadcast and seen in the wireless client utility.
Security	This field indicates the security mode of the SSID profile.
Modify	Click the Edit icon to configure the SSID profile.

6.3.1 Edit More AP

Use this screen to edit an SSID profile. Click the **Edit** icon next to an SSID in the **More AP** screen. The following screen displays.

Figure 29 Wireless > More AP: Edit

Wireless Network Setup

Wireless : Enable Wireless LAN

Wireless Network Settings

Wireless Network Name(SSID):

Hide SSID

BSSID : 40:4a:03:ff:5b:e5

Security Level

No Security Basic More Secure (Recommended)

Security Mode :

Enter 8-63 characters (a-z, A-Z, and 0-9) or 64 hexadecimal digits (a-f and 0-9). Spaces and underscores are not allowed.

Pre-Shared Key : [more...](#)

The following table describes the fields in this screen.

Table 19 Wireless > More AP: Edit

LABEL	DESCRIPTION
Wireless Network Setup	
Wireless	Select the Enable Wireless LAN check box to activate the wireless LAN.
Wireless Network Settings	
Wireless Network Name (SSID)	The SSID (Service Set IDentity) identifies the service set with which a wireless device is associated. Wireless devices associating to the access point (AP) must have the same SSID. Enter a descriptive name (up to 32 English keyboard characters) for the wireless LAN.
Hide SSID	Select this check box to hide the SSID in the outgoing beacon frame so a station cannot obtain the SSID through scanning using a site survey tool.
BSSID	This shows the MAC address of the wireless interface on the ZyXEL Device when wireless LAN is enabled.
Security Level	
Security Mode	Select Basic (WEP) or More Secure (WPA(2)-PSK, WPA(2)) to add security on this wireless network. The wireless clients which want to associate to this network must have same wireless security settings as the ZyXEL Device. After you select to use a security, additional options appears in this screen. Or you can select No Security to allow any client to associate this network without any data encryption or authentication. See Section 6.2.1 on page 127 for more details about this field.
Apply	Click Apply to save your changes.
Back	Click Back to exit this screen without saving.

6.4 The WPS Screen

Use this screen to configure WiFi Protected Setup (WPS) on your ZyXEL Device.

WPS allows you to quickly set up a wireless network with strong security, without having to configure security settings manually. Set up each WPS connection between two devices. Both devices must support WPS. See [Section 6.7.6.3 on page 147](#) for more information about WPS.

Note: The ZyXEL Device applies the security settings of the **SSID1** profile (see [Section 6.2 on page 125](#)). If you want to use the WPS feature, make sure you have set the security mode of **SSID1** to **WPA-PSK, WPA2-PSK** or **No Security**.

Click **Network Setting > Wireless > WPS**. The following screen displays. Select **Enable** and click **Apply** to activate the WPS function. Then you can configure the WPS settings in this screen.

Figure 30 Network Setting > Wireless > WPS

The following table describes the labels in this screen.

Table 20 Network Setting > Wireless > WPS

LABEL	DESCRIPTION
Enable WPS	Select Enable to activate WPS on the ZyXEL Device.
Add a new device with WPS Method	
Method 1PBC	Use this section to set up a WPS wireless network using Push Button Configuration (PBC).
WPS	Click this button to add another WPS-enabled wireless device (within wireless range of the ZyXEL Device) to your wireless network. This button may either be a physical button on the outside of device, or a menu button similar to the WPS button on this screen. Note: You must press the other wireless device's WPS button within two minutes of pressing this button.
Method 2 PIN	Use this section to set up a WPS wireless network by entering the PIN (Personal Identification Number) of the client into the ZyXEL Device.

Table 20 Network Setting > Wireless > WPS (continued)

LABEL	DESCRIPTION
Register	<p>Enter the PIN of the device that you are setting up a WPS connection with and click Register to authenticate and add the wireless device to your wireless network.</p> <p>You can find the PIN either on the outside of the device, or by checking the device's settings.</p> <p>Note: You must also activate WPS on that device within two minutes to have it present its PIN to the ZyXEL Device.</p>
WPS Configuration Summary	
AP PIN	<p>The PIN of the ZyXEL Device is shown here. Enter this PIN in the configuration utility of the device you want to connect to using WPS.</p> <p>The PIN is not necessary when you use WPS push-button method.</p> <p>Click the Generate New PIN button to have the ZyXEL Device create a new PIN.</p>
Status	<p>This displays Configured when the ZyXEL Device has connected to a wireless network using WPS or Enable WPS is selected and wireless or wireless security settings have been changed. The current wireless and wireless security settings also appear in the screen.</p> <p>This displays Not Configured when there is no wireless or wireless security changes on the ZyXEL Device or you click Release Configuration to remove the configured wireless and wireless security settings.</p>
Release Configuration	<p>This button is available when the WPS status is Configured.</p> <p>Click this button to remove all configured wireless and wireless security settings for WPS connections on the ZyXEL Device.</p>
802.11 Mode	This is the 802.11 mode used. Only compliant WLAN devices can associate with the ZyXEL Device.
SSID	This is the name of the wireless network.
Security	This is the type of wireless security employed by the network.
Apply	Click Apply to save your changes.

6.5 The WMM Screen

Use this screen to enable or disable Wi-Fi MultiMedia (WMM) wireless networks for multimedia applications.

Click **Network Setting > Wireless > WMM**. The following screen displays.

Figure 31 Network Setting > Wireless > WMM

WMM (WiFi MultiMedia)

- Enable WMM of SSID1
- Enable WMM of SSID2
- Enable WMM of SSID3
- Enable WMM of SSID4
- Enable WMM Automatic Power Save Delivery(APSD)

The following table describes the labels in this screen.

Table 21 Network Setting > Wireless > WMM

LABEL	DESCRIPTION
Enable WMM of SSID1 ~4	This enables the ZyXEL Device to automatically give a service a priority level according to the ToS value in the IP header of packets it sends. WMM QoS (Wifi MultiMedia Quality of Service) gives high priority to voice and video, which makes them run more smoothly.
Enable WMM Automatic Power Save Deliver (APSD)	Click this to increase battery life for battery-powered wireless clients. APSD uses a longer beacon interval when transmitting traffic that does not require a short packet exchange interval.
Apply	Click Apply to save your changes.
Cancel	Click Cancel to restore your previously saved settings.

6.6 Scheduling Screen

Click **Network Setting > Wireless > Scheduling** to open the **Wireless LAN Scheduling** screen. Use this screen to configure when the ZyXEL Device enables or disables the wireless LAN.

Figure 32 Network Setting > Wireless > Scheduling

Wireless LAN Scheduling : Enable Disable

WLAN Status	Day	During the following times (24-Hour Format)
<input type="radio"/> On <input checked="" type="radio"/> Off	<input type="checkbox"/> Everyday	[00] (hour) [00] (min) ~ [00] (hour) [00] (min)
<input type="radio"/> On <input checked="" type="radio"/> Off	<input type="checkbox"/> Mon.	[00] (hour) [00] (min) ~ [00] (hour) [00] (min)
<input type="radio"/> On <input checked="" type="radio"/> Off	<input type="checkbox"/> Tue.	[00] (hour) [00] (min) ~ [00] (hour) [00] (min)
<input type="radio"/> On <input checked="" type="radio"/> Off	<input type="checkbox"/> Wed.	[00] (hour) [00] (min) ~ [00] (hour) [00] (min)
<input type="radio"/> On <input checked="" type="radio"/> Off	<input type="checkbox"/> Thu.	[00] (hour) [00] (min) ~ [00] (hour) [00] (min)
<input type="radio"/> On <input checked="" type="radio"/> Off	<input type="checkbox"/> Fri.	[00] (hour) [00] (min) ~ [00] (hour) [00] (min)
<input type="radio"/> On <input checked="" type="radio"/> Off	<input type="checkbox"/> Sat.	[00] (hour) [00] (min) ~ [00] (hour) [00] (min)
<input type="radio"/> On <input checked="" type="radio"/> Off	<input type="checkbox"/> Sun.	[00] (hour) [00] (min) ~ [00] (hour) [00] (min)

Note :
Specify the same begin time and end time means the whole day schedule.

Apply Cancel

The following table describes the labels in this screen.

Table 22 Network Setting > Wireless > Scheduling

LABEL	DESCRIPTION
Wireless LAN Scheduling	Select Enable to activate wireless LAN scheduling on your ZyXEL Device.
WLAN status	Select On or Off to enable or disable the wireless LAN.
Day	Select the day(s) you want to turn the wireless LAN on or off.
During the following times	Specify the time period during which to apply the schedule. For example, you want the wireless network to be only available during work hours. Check Mon ~ Fri in the day column, and specify 8:00 ~ 18:00 in the time table.
Apply	Click Apply to save your changes.
Cancel	Click Cancel to restore your previously saved settings.

6.7 Technical Reference

This section discusses wireless LANs in depth. For more information, see the appendix.

6.7.1 Additional Wireless Terms

The following table describes some wireless network terms and acronyms used in the ZyXEL Device's web configurator.

Table 23 Additional Wireless Terms

TERM	DESCRIPTION
RTS/CTS Threshold	<p>In a wireless network which covers a large area, wireless devices are sometimes not aware of each other's presence. This may cause them to send information to the AP at the same time and result in information colliding and not getting through.</p> <p>By setting this value lower than the default value, the wireless devices must sometimes get permission to send information to the ZyXEL Device. The lower the value, the more often the devices must get permission.</p> <p>If this value is greater than the fragmentation threshold value (see below), then wireless devices never have to get permission to send information to the ZyXEL Device.</p>
Preamble	A preamble affects the timing in your wireless network. There are two preamble modes: long and short. If a device uses a different preamble mode than the ZyXEL Device does, it cannot communicate with the ZyXEL Device.
Authentication	The process of verifying whether a wireless device is allowed to use the wireless network.
Fragmentation Threshold	A small fragmentation threshold is recommended for busy networks, while a larger threshold provides faster performance if the network is not very busy.

6.7.2 Wireless Security Overview

By their nature, radio communications are simple to intercept. For wireless data networks, this means that anyone within range of a wireless network without security can not only read the data passing over the airwaves, but also join the network. Once an unauthorized person has access to the network, he or she can steal information or introduce malware (malicious software) intended to compromise the network. For these reasons, a variety of security systems have been developed to ensure that only authorized people can use a wireless data network, or understand the data carried on it.

These security standards do two things. First, they authenticate. This means that only people presenting the right credentials (often a username and password, or a "key" phrase) can access the network. Second, they encrypt. This means that the information sent over the air is encoded. Only people with the code key can understand the information, and only people who have been authenticated are given the code key.

These security standards vary in effectiveness. Some can be broken, such as the old Wired Equivalent Protocol (WEP). Using WEP is better than using no security at all, but it will not keep a determined attacker out. Other security standards are secure in themselves but can be broken if a user does not use them properly. For example, the WPA-PSK security standard is very secure if you use a long key which is difficult for an attacker's software to guess - for example, a twenty-letter long string of apparently random numbers and letters - but it is not very secure if you use a short key which is very easy to guess - for example, a three-letter word from the dictionary.

Because of the damage that can be done by a malicious attacker, it's not just people who have sensitive information on their network who should use security. Everybody who uses any wireless network should ensure that effective security is in place.

A good way to come up with effective security keys, passwords and so on is to use obscure information that you personally will easily remember, and to enter it in a way that appears random and does not include real words. For example, if your mother owns a 1970 Dodge Challenger and her favorite movie is Vanishing Point (which you know was made in 1971) you could use "70dodchal71vanpoi" as your security key.

The following sections introduce different types of wireless security you can set up in the wireless network.

6.7.2.1 SSID

Normally, the ZyXEL Device acts like a beacon and regularly broadcasts the SSID in the area. You can hide the SSID instead, in which case the ZyXEL Device does not broadcast the SSID. In addition, you should change the default SSID to something that is difficult to guess.

This type of security is fairly weak, however, because there are ways for unauthorized wireless devices to get the SSID. In addition, unauthorized wireless devices can still see the information that is sent in the wireless network.

6.7.2.2 MAC Address Filter

Every device that can use a wireless network has a unique identification number, called a MAC address.¹ A MAC address is usually written using twelve hexadecimal characters²; for example, 00A0C5000002 or 00:A0:C5:00:00:02. To get the MAC address for each device in the wireless network, see the device's User's Guide or other documentation.

-
1. Some wireless devices, such as scanners, can detect wireless networks but cannot use wireless networks. These kinds of wireless devices might not have MAC addresses.
 2. Hexadecimal characters are 0, 1, 2, 3, 4, 5, 6, 7, 8, 9, A, B, C, D, E, and F.

You can use the MAC address filter to tell the ZyXEL Device which devices are allowed or not allowed to use the wireless network. If a device is allowed to use the wireless network, it still has to have the correct information (SSID, channel, and security). If a device is not allowed to use the wireless network, it does not matter if it has the correct information.

This type of security does not protect the information that is sent in the wireless network. Furthermore, there are ways for unauthorized wireless devices to get the MAC address of an authorized device. Then, they can use that MAC address to use the wireless network.

6.7.2.3 User Authentication

Authentication is the process of verifying whether a wireless device is allowed to use the wireless network. You can make every user log in to the wireless network before using it. However, every device in the wireless network has to support IEEE 802.1x to do this.

For wireless networks, you can store the user names and passwords for each user in a RADIUS server. This is a server used in businesses more than in homes. If you do not have a RADIUS server, you cannot set up user names and passwords for your users.

Unauthorized wireless devices can still see the information that is sent in the wireless network, even if they cannot use the wireless network. Furthermore, there are ways for unauthorized wireless users to get a valid user name and password. Then, they can use that user name and password to use the wireless network.

6.7.2.4 Encryption

Wireless networks can use encryption to protect the information that is sent in the wireless network. Encryption is like a secret code. If you do not know the secret code, you cannot understand the message.

The types of encryption you can choose depend on the type of authentication. (See [Section 6.7.2.3 on page 142](#) for information about this.)

Table 24 Types of Encryption for Each Type of Authentication

	NO AUTHENTICATION	RADIUS SERVER
Weakest ↑ ↓	No Security	WPA
	Static WEP	
	WPA-PSK	
Strongest	WPA2-PSK	WPA2

For example, if the wireless network has a RADIUS server, you can choose **WPA** or **WPA2**. If users do not log in to the wireless network, you can choose no encryption, **Static WEP**, **WPA-PSK**, or **WPA2-PSK**.

Usually, you should set up the strongest encryption that every device in the wireless network supports. For example, suppose you have a wireless network with the ZyXEL Device and you do not have a RADIUS server. Therefore, there is no authentication. Suppose the wireless network has two devices. Device A only supports WEP, and device B supports WEP and WPA. Therefore, you should set up **Static WEP** in the wireless network.

Note: It is recommended that wireless networks use **WPA-PSK**, **WPA**, or stronger encryption. The other types of encryption are better than none at all, but it is still possible for unauthorized wireless devices to figure out the original information pretty quickly.

When you select **WPA2** or **WPA2-PSK** in your ZyXEL Device, you can also select an option (**WPA compatible**) to support WPA as well. In this case, if some of the devices support WPA and some support WPA2, you should set up **WPA2-PSK** or **WPA2** (depending on the type of wireless network login) and select the **WPA compatible** option in the ZyXEL Device.

Many types of encryption use a key to protect the information in the wireless network. The longer the key, the stronger the encryption. Every device in the wireless network must have the same key.

6.7.3 Signal Problems

Because wireless networks are radio networks, their signals are subject to limitations of distance, interference and absorption.

Problems with distance occur when the two radios are too far apart. Problems with interference occur when other radio waves interrupt the data signal. Interference may come from other radio transmissions, such as military or air traffic control communications, or from machines that are coincidental emitters such as electric motors or microwaves. Problems with absorption occur when physical objects (such as thick walls) are between the two radios, muffling the signal.

6.7.4 BSS

A Basic Service Set (BSS) exists when all communications between wireless stations or between a wireless station and a wired network client go through one access point (AP).

Intra-BSS traffic is traffic between wireless stations in the BSS. When Intra-BSS traffic blocking is disabled, wireless station A and B can access the wired network

and communicate with each other. When Intra-BSS traffic blocking is enabled, wireless station A and B can still access the wired network but cannot communicate with each other.

Figure 33 Basic Service set

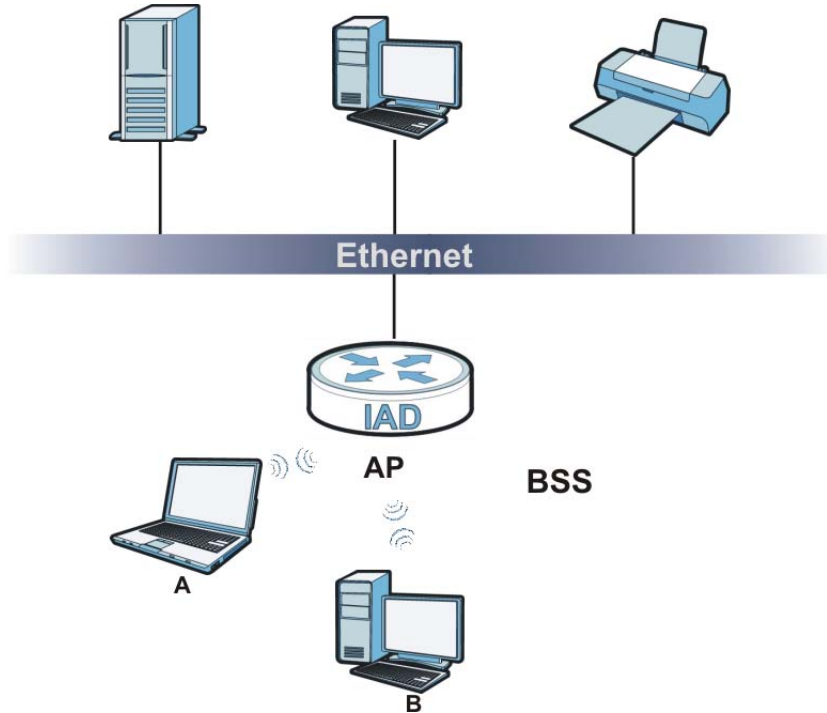

6.7.5 MBSSID

Traditionally, you need to use different APs to configure different Basic Service Sets (BSSs). As well as the cost of buying extra APs, there is also the possibility of channel interference. The ZyXEL Device's MBSSID (Multiple Basic Service Set Identifier) function allows you to use one access point to provide several BSSs simultaneously. You can then assign varying QoS priorities and/or security modes to different SSIDs.

Wireless devices can use different BSSIDs to associate with the same AP.

6.7.5.1 Notes on Multiple BSSs

- A maximum of eight BSSs are allowed on one AP simultaneously.
- You must use different keys for different BSSs. If two wireless devices have different BSSIDs (they are in different BSSs), but have the same keys, they may hear each other's communications (but not communicate with each other).
- MBSSID should not replace but rather be used in conjunction with 802.1x security.

6.7.6 WiFi Protected Setup (WPS)

Your ZyXEL Device supports WiFi Protected Setup (WPS), which is an easy way to set up a secure wireless network. WPS is an industry standard specification, defined by the WiFi Alliance.

WPS allows you to quickly set up a wireless network with strong security, without having to configure security settings manually. Each WPS connection works between two devices. Both devices must support WPS (check each device's documentation to make sure).

Depending on the devices you have, you can either press a button (on the device itself, or in its configuration utility) or enter a PIN (a unique Personal Identification Number that allows one device to authenticate the other) in each of the two devices. When WPS is activated on a device, it has two minutes to find another device that also has WPS activated. Then, the two devices connect and set up a secure network by themselves.

6.7.6.1 Push Button Configuration

WPS Push Button Configuration (PBC) is initiated by pressing a button on each WPS-enabled device, and allowing them to connect automatically. You do not need to enter any information.

Not every WPS-enabled device has a physical WPS button. Some may have a WPS PBC button in their configuration utilities instead of or in addition to the physical button.

Take the following steps to set up WPS using the button.

- 1 Ensure that the two devices you want to set up are within wireless range of one another.
- 2 Look for a WPS button on each device. If the device does not have one, log into its configuration utility and locate the button (see the device's User's Guide for how to do this - for the ZyXEL Device, see [Section 6.4 on page 135](#)).
- 3 Press the button on one of the devices (it doesn't matter which). For the ZyXEL Device you must press the WPS button for more than three seconds.
- 4 Within two minutes, press the button on the other device. The registrar sends the network name (SSID) and security key through an secure connection to the enrollee.

If you need to make sure that WPS worked, check the list of associated wireless clients in the AP's configuration utility. If you see the wireless client in the list, WPS was successful.

6.7.6.2 PIN Configuration

Each WPS-enabled device has its own PIN (Personal Identification Number). This may either be static (it cannot be changed) or dynamic (in some devices you can generate a new PIN by clicking on a button in the configuration interface).

Use the PIN method instead of the push-button configuration (PBC) method if you want to ensure that the connection is established between the devices you specify, not just the first two devices to activate WPS in range of each other. However, you need to log into the configuration interfaces of both devices to use the PIN method.

When you use the PIN method, you must enter the PIN from one device (usually the wireless client) into the second device (usually the Access Point or wireless router). Then, when WPS is activated on the first device, it presents its PIN to the second device. If the PIN matches, one device sends the network and security information to the other, allowing it to join the network.

Take the following steps to set up a WPS connection between an access point or wireless router (referred to here as the AP) and a client device using the PIN method.

- 1 Ensure WPS is enabled on both devices.
- 2 Access the WPS section of the AP's configuration interface. See the device's User's Guide for how to do this.
- 3 Look for the client's WPS PIN; it will be displayed either on the device, or in the WPS section of the client's configuration interface (see the device's User's Guide for how to find the WPS PIN - for the ZyXEL Device, see [Section 6.4 on page 135](#)).
- 4 Enter the client's PIN in the AP's configuration interface.
- 5 If the client device's configuration interface has an area for entering another device's PIN, you can either enter the client's PIN in the AP, or enter the AP's PIN in the client - it does not matter which.
- 6 Start WPS on both devices within two minutes.
- 7 Use the configuration utility to activate WPS, not the push-button on the device itself.
- 8 On a computer connected to the wireless client, try to connect to the Internet. If you can connect, WPS was successful.

If you cannot connect, check the list of associated wireless clients in the AP's configuration utility. If you see the wireless client in the list, WPS was successful.

The following figure shows a WPS-enabled wireless client (installed in a notebook computer) connecting to the WPS-enabled AP via the PIN method.

Figure 34 Example WPS Process: PIN Method

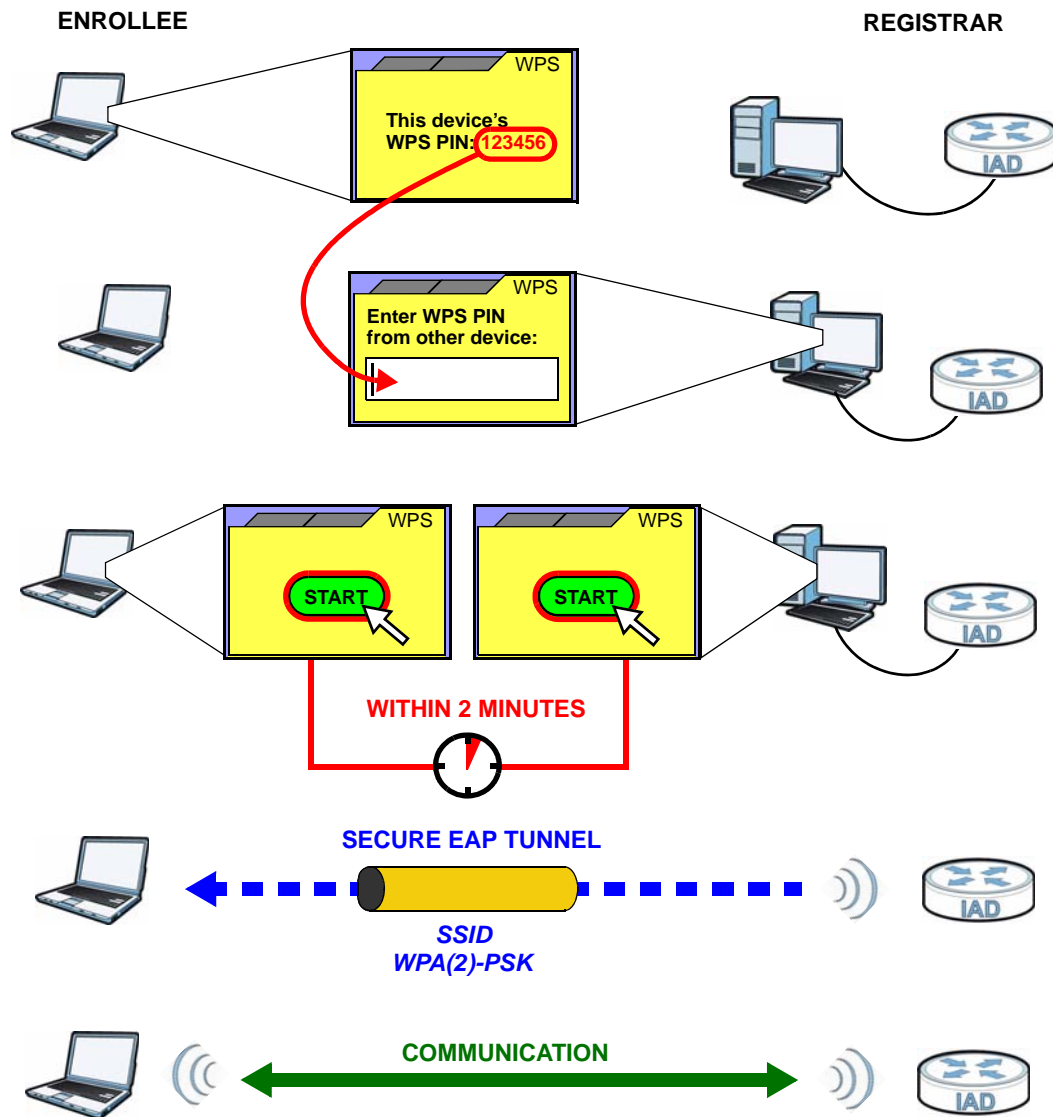

6.7.6.3 How WPS Works

When two WPS-enabled devices connect, each device must assume a specific role. One device acts as the registrar (the device that supplies network and security settings) and the other device acts as the enrollee (the device that receives network and security settings). The registrar creates a secure EAP (Extensible Authentication Protocol) tunnel and sends the network name (SSID) and the WPA-PSK or WPA2-PSK pre-shared key to the enrollee. Whether WPA-PSK or WPA2-PSK is used depends on the standards supported by the devices. If the registrar is already part of a network, it sends the existing information. If not, it generates the SSID and WPA(2)-PSK randomly.

The following figure shows a WPS-enabled client (installed in a notebook computer) connecting to a WPS-enabled access point.

Figure 35 How WPS works

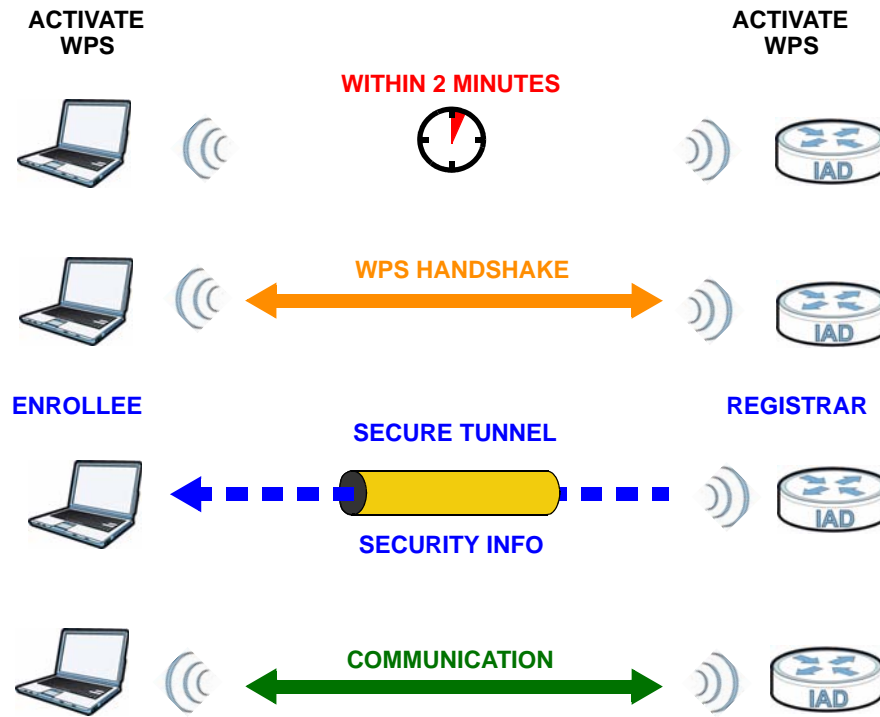

The roles of registrar and enrollee last only as long as the WPS setup process is active (two minutes). The next time you use WPS, a different device can be the registrar if necessary.

The WPS connection process is like a handshake; only two devices participate in each WPS transaction. If you want to add more devices you should repeat the process with one of the existing networked devices and the new device.

Note that the access point (AP) is not always the registrar, and the wireless client is not always the enrollee. All WPS-certified APs can be a registrar, and so can some WPS-enabled wireless clients.

By default, a WPS device is “unconfigured”. This means that it is not part of an existing network and can act as either enrollee or registrar (if it supports both functions). If the registrar is unconfigured, the security settings it transmits to the enrollee are randomly-generated. Once a WPS-enabled device has connected to another device using WPS, it becomes “configured”. A configured wireless client can still act as enrollee or registrar in subsequent WPS connections, but a configured access point can no longer act as enrollee. It will be the registrar in all subsequent WPS connections in which it is involved. If you want a configured AP to act as an enrollee, you must reset it to its factory defaults.

6.7.6.4 Example WPS Network Setup

This section shows how security settings are distributed in an example WPS setup.

The following figure shows an example network. In step **1**, both **AP1** and **Client 1** are unconfigured. When WPS is activated on both, they perform the handshake. In this example, **AP1** is the registrar, and **Client 1** is the enrollee. The registrar randomly generates the security information to set up the network, since it is unconfigured and has no existing information.

Figure 36 WPS: Example Network Step 1

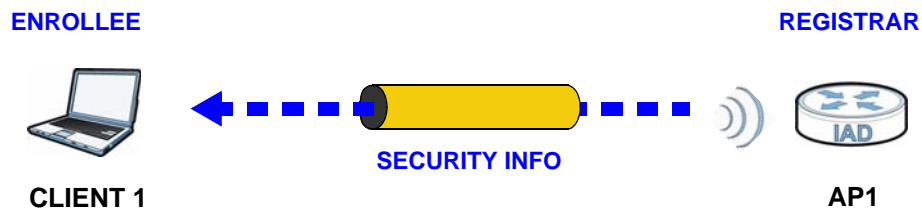

In step **2**, you add another wireless client to the network. You know that **Client 1** supports registrar mode, but it is better to use **AP1** for the WPS handshake with the new client since you must connect to the access point anyway in order to use the network. In this case, **AP1** must be the registrar, since it is configured (it already has security information for the network). **AP1** supplies the existing security information to **Client 2**.

Figure 37 WPS: Example Network Step 2

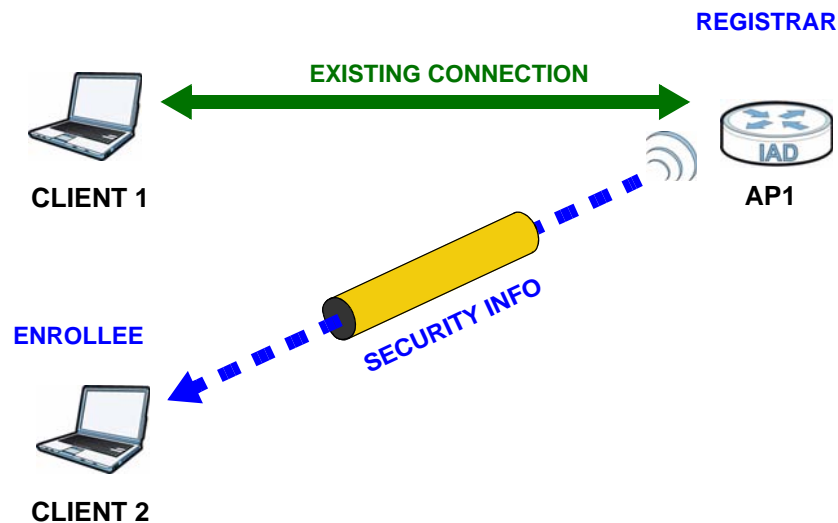

In step 3, you add another access point (**AP2**) to your network. **AP2** is out of range of **AP1**, so you cannot use **AP1** for the WPS handshake with the new access point. However, you know that **Client 2** supports the registrar function, so you use it to perform the WPS handshake instead.

Figure 38 WPS: Example Network Step 3

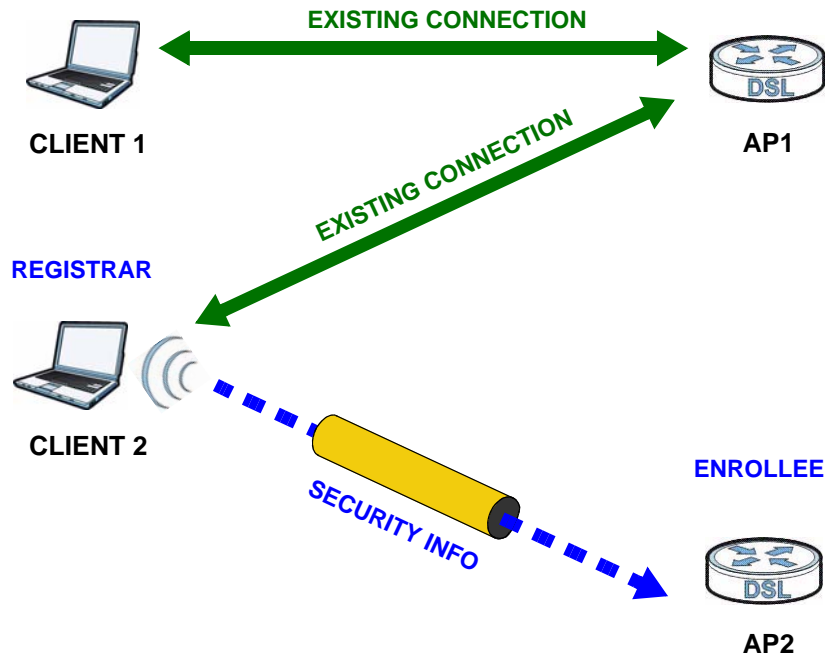

6.7.6.5 Limitations of WPS

WPS has some limitations of which you should be aware.

- WPS works in Infrastructure networks only (where an AP and a wireless client communicate). It does not work in Ad-Hoc networks (where there is no AP).
- When you use WPS, it works between two devices only. You cannot enroll multiple devices simultaneously, you must enroll one after the other.

For instance, if you have two enrollees and one registrar you must set up the first enrollee (by pressing the WPS button on the registrar and the first enrollee, for example), then check that it successfully enrolled, then set up the second device in the same way.

- WPS works only with other WPS-enabled devices. However, you can still add non-WPS devices to a network you already set up using WPS.

WPS works by automatically issuing a randomly-generated WPA-PSK or WPA2-PSK pre-shared key from the registrar device to the enrollee devices. Whether the network uses WPA-PSK or WPA2-PSK depends on the device. You can check the configuration interface of the registrar device to discover the key the network is using (if the device supports this feature). Then, you can enter the key into the non-WPS device and join the network as normal (the non-WPS device must also support WPA-PSK or WPA2-PSK).

- When you use the PBC method, there is a short period (from the moment you press the button on one device to the moment you press the button on the other device) when any WPS-enabled device could join the network. This is because the registrar has no way of identifying the “correct” enrollee, and cannot differentiate between your enrollee and a rogue device. This is a possible way for a hacker to gain access to a network.

You can easily check to see if this has happened. WPS works between only two devices simultaneously, so if another device has enrolled your device will be unable to enroll, and will not have access to the network. If this happens, open the access point’s configuration interface and look at the list of associated clients (usually displayed by MAC address). It does not matter if the access point is the WPS registrar, the enrollee, or was not involved in the WPS handshake; a rogue device must still associate with the access point to gain access to the network. Check the MAC addresses of your wireless clients (usually printed on a label on the bottom of the device). If there is an unknown MAC address you can remove it or reset the AP.

Home Networking

7.1 Overview

A Local Area Network (LAN) is a shared communication system to which many computers are attached. A LAN is usually located in one immediate area such as a building or floor of a building.

The LAN screens can help you configure a LAN DHCP server and manage IP addresses.

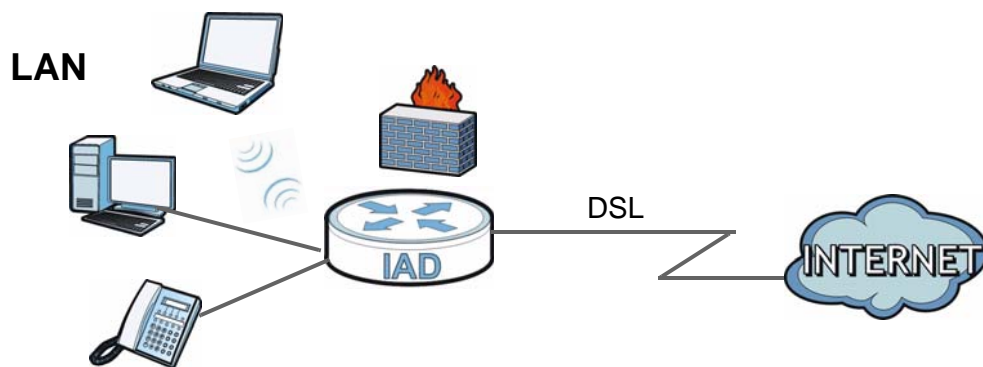

7.1.1 What You Can Do in this Chapter

- Use the **LAN IP** screen to set the LAN IP address, subnet mask, and DHCP settings ([Section 7.2 on page 157](#)).
- Use the **DHCP Server** screen to configure the DNS server information that the ZyXEL Device sends to the DHCP client devices on the LAN ([Section 7.3 on page 158](#)).
- Use the **UPnP** screen to enable UPnP ([Section 7.4 on page 160](#)).
- Use the **File Sharing** screen to enable file-sharing server ([Section 7.5 on page 161](#)).
- Use the **Media Server** screen to enable or disable the sharing of media files ([Section 7.6 on page 163](#)).
- Use the **Printer Server** screen to enable the print server ([Section 7.7 on page 164](#)).

7.1.2 What You Need To Know

The following terms and concepts may help as you read this chapter.

7.1.2.1 About LAN

IP Address

Similar to the way houses on a street share a common street name, so too do computers on a LAN share one common network number. This is known as an Internet Protocol address.

Subnet Mask

The subnet mask specifies the network number portion of an IP address. Your ZyXEL Device will compute the subnet mask automatically based on the IP address that you entered. You don't need to change the subnet mask computed by the ZyXEL Device unless you are instructed to do otherwise.

DHCP

DHCP (Dynamic Host Configuration Protocol) allows clients to obtain TCP/IP configuration at start-up from a server. This ZyXEL Device has a built-in DHCP server capability that assigns IP addresses and DNS servers to systems that support DHCP client capability.

DNS

DNS (Domain Name System) maps a domain name to its corresponding IP address and vice versa. The DNS server is extremely important because without it, you must know the IP address of a computer before you can access it. The DNS server addresses you enter when you set up DHCP are passed to the client machines along with the assigned IP address and subnet mask.

7.1.2.2 About UPnP

How do I know if I'm using UPnP?

UPnP hardware is identified as an icon in the Network Connections folder (Windows XP). Each UPnP compatible device installed on your network will appear as a separate icon. Selecting the icon of a UPnP device will allow you to access the information and properties of that device.

Cautions with UPnP

The automated nature of NAT traversal applications in establishing their own services and opening firewall ports may present network security issues. Network information and configuration may also be obtained and modified by users in some network environments.

When a UPnP device joins a network, it announces its presence with a multicast message. For security reasons, the ZyXEL Device allows multicast messages on the LAN only.

All UPnP-enabled devices may communicate freely with each other without additional configuration. Disable UPnP if this is not your intention.

UPnP and ZyXEL

ZyXEL has achieved UPnP certification from the Universal Plug and Play Forum UPnP™ Implementers Corp. (UIC). ZyXEL's UPnP implementation supports Internet Gateway Device (IGD) 1.0.

See [Section 7.9 on page 170](#) for examples of installing and using UPnP.

7.1.2.3 About File Sharing

User Account

This gives you access to the file sharing server. It includes your user name and password.

Workgroup name

This is the name given to a set of computers that are connected on a network and share resources such as a printer or files. Windows automatically assigns the workgroup name when you set up a network.

Shares

When settings are set to default, each USB device connected to the ZyXEL Device is given a folder, called a "share". If a USB hard drive connected to the ZyXEL Device has more than one partition, then each partition will be allocated a share. You can also configure a "share" to be a sub-folder or file on the USB device.

File Systems

A file system is a way of storing and organizing files on your hard drive and storage device. Often different operating systems such as Windows or Linux have

different file systems. The file sharing feature on your ZyXEL Device supports File Allocation Table (FAT), FAT32, and New Technology File System (NTFS).

Common Internet File System

The ZyXEL Device uses Common Internet File System (CIFS) protocol for its file sharing functions. CIFS compatible computers can access the USB file storage devices connected to the ZyXEL Device. CIFS protocol is supported on Microsoft Windows, Linux Samba and other operating systems (refer to your systems specifications for CIFS compatibility).

7.1.2.4 About Printer Server

Print Server

This is a computer or other device which manages one or more printers, and which sends print jobs to each printer from the computer itself or other devices.

Operating System

An operating system (OS) is the interface which helps you manage a computer. Common examples are Microsoft Windows, Mac OS or Linux.

TCP/IP

TCP/IP (Transmission Control Protocol/ Internet Protocol) is a set of communications protocols that most of the Internet runs on.

Port

A port maps a network service such as http to a process running on your computer, such as a process run by your web browser. When traffic from the Internet is received on your computer, the port number is used to identify which process running on your computer it is intended for.

Line Printer Remote Protocol

The Line Printer Remote (LPR) Protocol is software that provides printer spooling and print-server features using TCP/IP to connect printers and computers on a network.

Supported OSs

Your operating system must support TCP/IP ports for printing and be compatible with the LPR protocol.

The following OSs support ZyXEL Device's printer sharing feature.

- Microsoft Windows 95, Windows 98 SE (Second Edition), Windows Me, Windows NT 4.0, Windows 2000, Windows XP or Macintosh OS X.

7.2 The LAN Setup Screen

Click **Network Setting > Home Networking** to open the **LAN Setup** screen. Use this screen to set the Local Area Network IP address and subnet mask of your ZyXEL Device and configure the DNS server information that the ZyXEL Device sends to the DHCP client devices on the LAN.

Figure 39 Network Setting > Home Networking > LAN Setup

The screenshot shows the LAN Setup configuration screen. It includes the following sections and fields:

- LAN IP Setup:**
 - IP Address: 192.168.1.1
 - Subnet Mask: 255.255.255.0
 - Note: (192.168.231.1 ~ 192.168.246.1 are reserved for VLAN.)
- DHCP Server State:**
 - DHCP: Enable Disable
- IP Addressing Values:**
 - IP Pool Starting Address: 192.168.1.33
 - Pool Size: 32
- DNS Values:**
 - DNS Server 1: 192.168.1.1
 - DNS Server 2: None
 - DNS Server 3: None

Buttons for 'Apply' and 'Cancel' are located at the bottom right.

The following table describes the fields in this screen.

Table 25 Network Setting > Home Networking > LAN Setup

LABEL	DESCRIPTION
LAN IP Setup	
IP Address	Enter the LAN IP address you want to assign to your ZyXEL Device in dotted decimal notation, for example, 192.168.1.1 (factory default).
IP Subnet Mask	Type the subnet mask of your network in dotted decimal notation, for example 255.255.255.0 (factory default). Your ZyXEL Device automatically computes the subnet mask based on the IP address you enter, so do not change this field unless you are instructed to do so.
DHCP Server State	

Table 25 Network Setting > Home Networking > LAN Setup (continued)

LABEL	DESCRIPTION
DHCP	Select Enable to have your ZyXEL Device assign IP addresses, an IP default gateway and DNS servers to LAN computers and other devices that are DHCP clients. If you select Disable , you need to manually configure the IP addresses of the computers and other devices on your LAN. When DHCP is used, the following fields need to be set.
IP Addressing Values	
IP Pool Starting Address	This field specifies the first of the contiguous addresses in the IP address pool.
Pool Size	This field specifies the size, or count of the IP address pool.
DNS Values	
DNS Server 1-3	Select From ISP if your ISP dynamically assigns DNS server information (and the ZyXEL Device's WAN IP address). Select User-Defined if you have the IP address of a DNS server. Enter the DNS server's IP address in the field to the right. If you chose User-Defined , but leave the IP address set to 0.0.0.0, User-Defined changes to None after you click Apply . If you set a second choice to User-Defined , and enter the same IP address, the second User-Defined changes to None after you click Apply . Select None if you do not want to configure DNS servers. You must have another DHCP sever on your LAN, or else the computers must have their DNS server addresses manually configured. If you do not configure a DNS server, you must know the IP address of a computer in order to access it.
Apply	Click Apply to save your changes.
Cancel	Click Cancel to restore your previously saved settings.

7.3 The Static DHCP Screen

This table allows you to assign IP addresses on the LAN to specific individual computers based on their MAC Addresses.

Every Ethernet device has a unique MAC (Media Access Control) address. The MAC address is assigned at the factory and consists of six pairs of hexadecimal characters, for example, 00:A0:C5:00:00:02.

7.3.1 Before You Begin

Find out the MAC addresses of your network devices if you intend to add them to the **Static DHCP** screen.

Use this screen to change your ZyXEL Device's static DHCP settings. Click **Network Setting > Home Networking > Static DHCP** to open the following screen.

Figure 40 Network Setting > Home Networking > Static DHCP

#	Status	Host Name	MAC Address	IP Address	Reserve
1	💡	twpc13774-02	00:24:21:7e:20:96	192.168.1.58	<input type="checkbox"/>

The following table describes the labels in this screen.

Table 26 Network Setting > Home Networking > Static DHCP

LABEL	DESCRIPTION
Add new static lease	Click this to add a new static DHCP entry.
#	This is the index number of the entry.
Status	This field displays whether the client is connected to the ZyXEL Device.
Host Name	This field displays the client host name.
MAC Address	The MAC (Media Access Control) or Ethernet address on a LAN (Local Area Network) is unique to your computer (six pairs of hexadecimal notation). A network interface card such as an Ethernet adapter has a hardwired address that is assigned at the factory. This address follows an industry standard that ensures no other adapter has a similar address.
IP Address	This field displays the IP address relative to the # field listed above.
Reserve	Select the check box in the heading row to automatically select all check boxes or select the check box(es) in each entry to have the ZyXEL Device always assign the selected entry(ies)'s IP address(es) to the corresponding MAC address(es) (and host name(s)). You can select up to 128 entries in this table.
Apply	Click Apply to save your changes.
Cancel	Click Cancel to restore your previously saved settings.
Refresh	Click Refresh to reload the DHCP table.

If you click **Add new static lease** in the **Static DHCP** screen, the following screen displays.

Figure 41 Static DHCP: Add

MAC Address :

IP Address :

The following table describes the labels in this screen.

Table 27 Static DHCP: Add

LABEL	DESCRIPTION
MAC Address	Enter the MAC address of a computer on your LAN.
IP Address	Enter the IP address that you want to assign to the computer on your LAN with the MAC address that you will also specify.
Apply	Click Apply to save your changes.
Back	Click Back to exit this screen without saving.

7.4 The UPnP Screen

Universal Plug and Play (UPnP) is a distributed, open networking standard that uses TCP/IP for simple peer-to-peer network connectivity between devices. A UPnP device can dynamically join a network, obtain an IP address, convey its capabilities and learn about other devices on the network. In turn, a device can leave a network smoothly and automatically when it is no longer in use.

See [page 170](#) for more information on UPnP.

Use the following screen to configure the UPnP settings on your ZyXEL Device. Click **Network Setting > Home Networking > Static DHCP > UPnP** to display the screen shown next.

Figure 42 Network Setting > Home Networking > UPnP

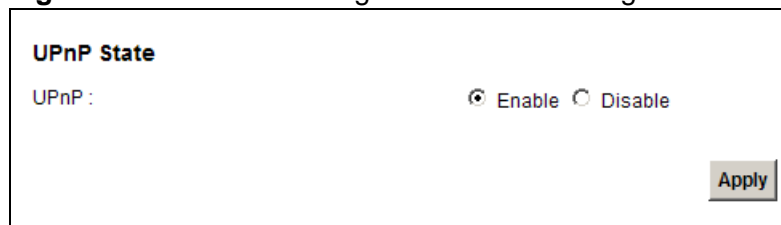

The following table describes the labels in this screen.

Table 28 Network Settings > Home Networking > UPnP

LABEL	DESCRIPTION
UPnP	Select Enable to activate UPnP. Be aware that anyone could use a UPnP application to open the web configurator's login screen without entering the ZyXEL Device's IP address (although you must still enter the password to access the web configurator).
Apply	Click Apply to save your changes.

7.5 The File Sharing Screen

You can share files on a USB memory stick or hard drive connected to your ZyXEL Device with users on your network.

The following figure is an overview of the ZyXEL Device's file server feature. Computers **A** and **B** can access files on a USB device (**C**) which is connected to the ZyXEL Device.

Figure 43 File Sharing Overview

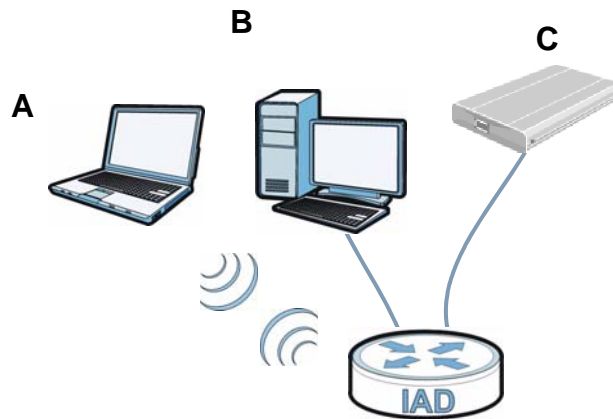

The ZyXEL Device will not be able to join the workgroup if your local area network has restrictions set up that do not allow devices to join a workgroup. In this case, contact your network administrator.

7.5.1 Before You Begin

Make sure the ZyXEL Device is connected to your network and turned on.

- 1 Connect the USB device to one of the ZyXEL Device's USB ports. Make sure the ZyXEL Device is connected to your network.
- 2 The ZyXEL Device detects the USB device and makes its contents available for browsing. If you are connecting a USB hard drive that comes with an external power supply, make sure it is connected to an appropriate power source that is on.

Note: If your USB device cannot be detected by ZyXEL Device, see the troubleshooting for suggestions.

Use this screen to set up file sharing using the ZyXEL Device. To access this screen, click **Network Setting > Home Networking > File Sharing**.

Figure 44 Network Setting > Home Networking > File Sharing

Server Configuration

File Sharing Services(SMB): Enable Disable

Share Directory List

Add new share

#	Status	Share Name	Share Path	Share Description	Modify
<input checked="" type="checkbox"/>		USB_Storage	GENERIC_USB	USB_Storage	

Apply Cancel

Each field is described in the following table.

Table 29 Network Setting > Home Networking > File Sharing

LABEL	DESCRIPTION
Server Configuration	
File Sharing Services (SMB)	Select Enable to activate file sharing through the ZyXEL Device.
Add new share	Click this to set up a new share on the ZyXEL Device.
#	Select the check box to make the share available to the network. Otherwise, clear this.
Status	This shows whether or not the share is available for sharing.
Share Name	This field displays the share name on the ZyXEL Device.
Share Path	This field displays the path for the share directories (folders) on the ZyXEL Device. These are the directories (folders) on your USB storage device.
Share Description	This field displays information about the share.
Modify	Click the Edit icon to change the settings of an existing share. Click the Delete icon to delete this share in the list.
Apply	Click Apply to save your changes.
Cancel	Click Cancel to restore your previously saved settings.

7.5.2 Add/Edit File Sharing

Use this screen to set up a new share or edit an existing share on the ZyXEL Device. Click **Add new share** in the **File Sharing** screen or click the **Edit** icon next to an existing share.

Figure 45 File Sharing: Add/Edit

Each field is described in the following table.

Table 30 File Sharing: Add/Edit

LABEL	DESCRIPTION
Volume	Select the volume in the USB storage device that you want to add as a share in the ZyXEL Device. This field is read-only when you are editing the share.
Share Path	Manually enter the file path for the share, or click the Browse button and select the folder that you want to add as a share. This field is read-only when you are editing the share.
Description	You can either enter a short description of the share, or leave this field blank.
Apply	Click Apply to save your changes.
Back	Click Back to return to the previous screen.

7.6 The Media Server Screen

The media server feature lets anyone on your network play video, music, and photos from the USB storage device connected to your ZyXEL Device (without having to copy them to another computer). The ZyXEL Device can function as a DLNA-compliant media server. The ZyXEL Device streams files to DLNA-compliant media clients (like Windows Media Player). The Digital Living Network Alliance (DLNA) is a group of personal computer and electronics companies that works to make products compatible in a home network.

The ZyXEL Device media server enables you to:

- Publish all shares for everyone to play media files in the USB storage device connected to the ZyXEL Device.

- Use hardware-based media clients like the DMA-2500 to play the files.

Note: Anyone on your network can play the media files in the published shares. No user name and password or other form of security is used. The media server is enabled by default with the video, photo, and music shares published.

To change your ZyXEL Device's media server settings, click **Network Setting > Home Networking > Media Server**. The screen appears as shown.

Figure 46 Network Setting > Home Networking > Media Server

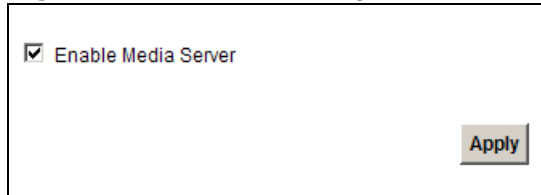

The following table describes the labels in this menu.

Table 31 Network Setting > Home Networking > Media Server

LABEL	DESCRIPTION
Enable Media Server	Check this to have the ZyXEL Device function as a DLNA-compliant media server. Enable the media server to let (DLNA-compliant) media clients on your network play media files located in the shares.
Apply	Click Apply to save your changes.

7.7 The Printer Server Screen

The ZyXEL Device allows you to share a USB printer on your LAN. You can do this by connecting a USB printer to one of the USB ports on the ZyXEL Device and then configuring a TCP/IP port on the computers connected to your network.

Figure 47 Sharing a USB Printer

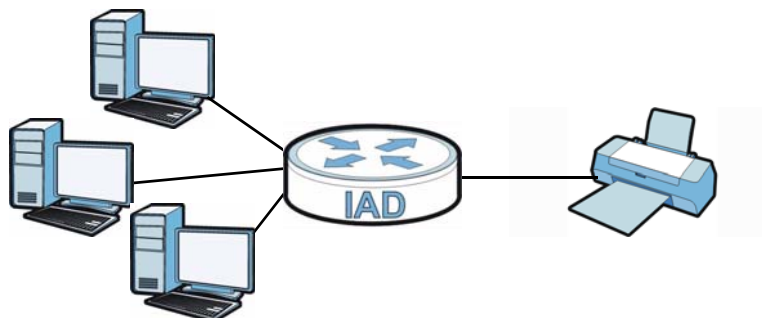

7.7.1 Before You Begin

To configure the print server you need the following:

- Your ZyXEL Device must be connected to your computer and any other devices on your network. The USB printer must be connected to your ZyXEL Device.
- A USB printer with the driver already installed on your computer.
- The computers on your network must have the printer software already installed before they can create a TCP/IP port for printing via the network. Follow your printer manufacturers instructions on how to install the printer software on your computer.

Note: Your printer's installation instructions may ask that you connect the printer to your computer. Connect your printer to the ZyXEL Device instead.

Use this screen to enable or disable sharing of a USB printer via your ZyXEL Device.

To access this screen, click **Network Setting > Home Networking > Printer Server**.

Figure 48 Network Setting > Home Networking > Printer Server

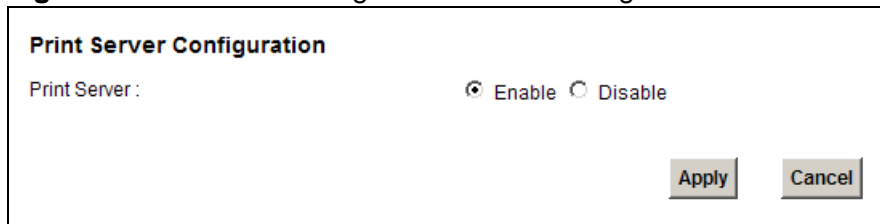

The following table describes the labels in this menu.

Table 32 Network Setting > Home Networking > Print Server

LABEL	DESCRIPTION
Printer Server	Select Enable to have the ZyXEL Device share a USB printer.
Apply	Click Apply to save your changes.
Cancel	Click Cancel to restore your previously saved settings.

7.8 Technical Reference

This section provides some technical background information about the topics covered in this chapter.

LANs, WANs and the ZyXEL Device

The actual physical connection determines whether the ZyXEL Device ports are LAN or WAN ports. There are two separate IP networks, one inside the LAN network and the other outside the WAN network as shown next.

Figure 49 LAN and WAN IP Addresses

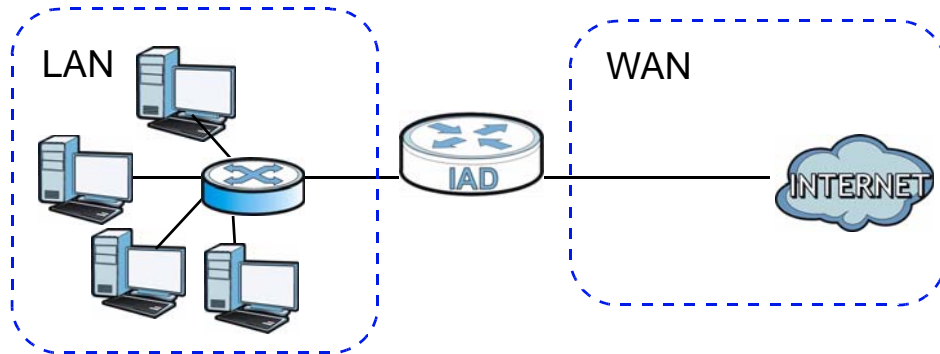

DHCP Setup

DHCP (Dynamic Host Configuration Protocol, RFC 2131 and RFC 2132) allows individual clients to obtain TCP/IP configuration at start-up from a server. You can configure the ZyXEL Device as a DHCP server or disable it. When configured as a server, the ZyXEL Device provides the TCP/IP configuration for the clients. If you turn DHCP service off, you must have another DHCP server on your LAN, or else the computer must be manually configured.

IP Pool Setup

The ZyXEL Device is pre-configured with a pool of IP addresses for the DHCP clients (DHCP Pool). See the product specifications in the appendices. Do not assign static IP addresses from the DHCP pool to your LAN computers.

LAN TCP/IP

The ZyXEL Device has built-in DHCP server capability that assigns IP addresses and DNS servers to systems that support DHCP client capability.

IP Address and Subnet Mask

Similar to the way houses on a street share a common street name, so too do computers on a LAN share one common network number.

Where you obtain your network number depends on your particular situation. If the ISP or your network administrator assigns you a block of registered IP

addresses, follow their instructions in selecting the IP addresses and the subnet mask.

If the ISP did not explicitly give you an IP network number, then most likely you have a single user account and the ISP will assign you a dynamic IP address when the connection is established. If this is the case, it is recommended that you select a network number from 192.168.0.0 to 192.168.255.0 and you must enable the Network Address Translation (NAT) feature of the ZyXEL Device. The Internet Assigned Number Authority (IANA) reserved this block of addresses specifically for private use; please do not use any other number unless you are told otherwise. Let's say you select 192.168.1.0 as the network number; which covers 254 individual addresses, from 192.168.1.1 to 192.168.1.254 (zero and 255 are reserved). In other words, the first three numbers specify the network number while the last number identifies an individual computer on that network.

Once you have decided on the network number, pick an IP address that is easy to remember, for instance, 192.168.1.1, for your ZyXEL Device, but make sure that no other device on your network is using that IP address.

The subnet mask specifies the network number portion of an IP address. Your ZyXEL Device will compute the subnet mask automatically based on the IP address that you entered. You don't need to change the subnet mask computed by the ZyXEL Device unless you are instructed to do otherwise.

Private IP Addresses

Every machine on the Internet must have a unique address. If your networks are isolated from the Internet, for example, only between your two branch offices, you can assign any IP addresses to the hosts without problems. However, the Internet Assigned Numbers Authority (IANA) has reserved the following three blocks of IP addresses specifically for private networks:

- 10.0.0.0 — 10.255.255.255
- 172.16.0.0 — 172.31.255.255
- 192.168.0.0 — 192.168.255.255

You can obtain your IP address from the IANA, from an ISP or it can be assigned from a private network. If you belong to a small organization and your Internet access is through an ISP, the ISP can provide you with the Internet addresses for your local networks. On the other hand, if you are part of a much larger organization, you should consult your network administrator for the appropriate IP addresses.

Note: Regardless of your particular situation, do not create an arbitrary IP address; always follow the guidelines above. For more information on address assignment, please refer to RFC 1597, "Address Allocation for Private Internets" and RFC 1466, "Guidelines for Management of IP Address Space".

ZyXEL Device Print Server Compatible USB Printers

The following is a list of USB printer models compatible with the ZyXEL Device print server.

Table 33 Compatible USB Printers

BRAND	MODEL
Brother	MFC7420
CANON	BJ F9000
CANON	i320
CANON	PIXMA MP450
CANON	PIXMA MP730
CANON	PIXMA MP780
CANON	PIXMA MP830
CANON	PIXUS ip2500
CANON	PIXMA ip4200
CANON	PIXMA ip5000
CANON	PIXUS 990i
EPSON	CX3500
EPSON	CX3900
EPSON	EPL-5800
EPSON	EPL-6200L
EPSON	LP-2500
EPSON	LP-8900
EPSON	RX 510
EPSON	RX 530
EPSON	Stylus 830U
EPSON	Stylus 1270
EPSON	Stylus C43UX
EPSON	Stylus C60
EPSON	Stylus Color 670
HP	Deskjet 5550
HP	Deskjet 5652
HP	Deskjet 830C
HP	Deskjet 845C
HP	Deskjet 1125C

Table 33 Compatible USB Printers (continued)

BRAND	MODEL
HP	Deskjet 1180C
HP	Deskjet 1220C
HP	Deskjet F4185
HP	Laserjet 1022
HP	Laserjet 1200
HP	Laserjet 2200D
HP	Laserjet 2420
HP	Color Laserjet 1500L
HP	Laserjet 3015
HP	Officejet 4255
HP	Officejet 5510
HP	Officejet 5610
HP	Officejet 7210
HP	Officejet Pro L7380
HP	Photosmart 2610
HP	Photosmart 3110
HP	Photosmart 7150
HP	Photosmart 7830
HP	Photosmart C5280
HP	Photosmart D5160
HP	PSC 1350
HP	PSC 1410
IBM	Infoprint 1332
LEXMARK	Z55
LEXMARK	Z705
OKI	B4350
SAMSUNG	ML-1710
SAMSUNG	SCX-4016

7.9 Installing UPnP in Windows Example

This section shows how to install UPnP in Windows Me and Windows XP.

Installing UPnP in Windows Me

Follow the steps below to install the UPnP in Windows Me.

- 1 Click **Start** and **Control Panel**. Double-click **Add/Remove Programs**.
- 2 Click the **Windows Setup** tab and select **Communication** in the **Components** selection box. Click **Details**.

Figure 50 Add/Remove Programs: Windows Setup: Communication

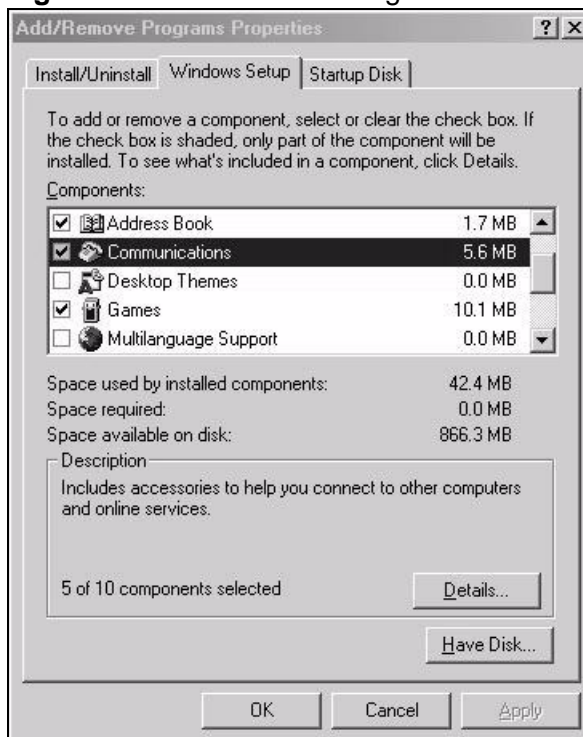

- 3 In the **Communications** window, select the **Universal Plug and Play** check box in the **Components** selection box.

Figure 51 Add/Remove Programs: Windows Setup: Communication: Components

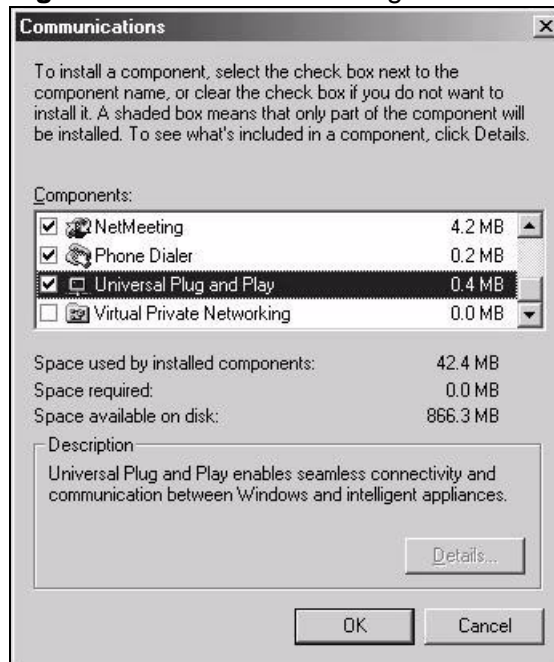

- 4 Click **OK** to go back to the **Add/Remove Programs Properties** window and click **Next**.
- 5 Restart the computer when prompted.

Installing UPnP in Windows XP

Follow the steps below to install the UPnP in Windows XP.

- 1 Click **Start** and **Control Panel**.
- 2 Double-click **Network Connections**.
- 3 In the **Network Connections** window, click **Advanced** in the main menu and select **Optional Networking Components**

Figure 52 Network Connections

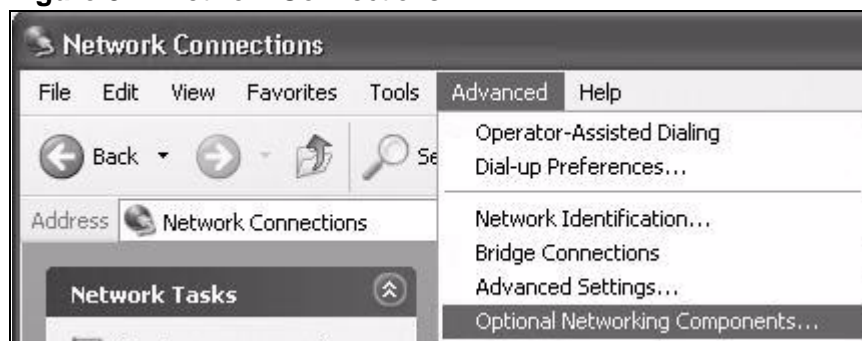

- 4 The **Windows Optional Networking Components Wizard** window displays. Select **Networking Service** in the **Components** selection box and click **Details**.

Figure 53 Windows Optional Networking Components Wizard

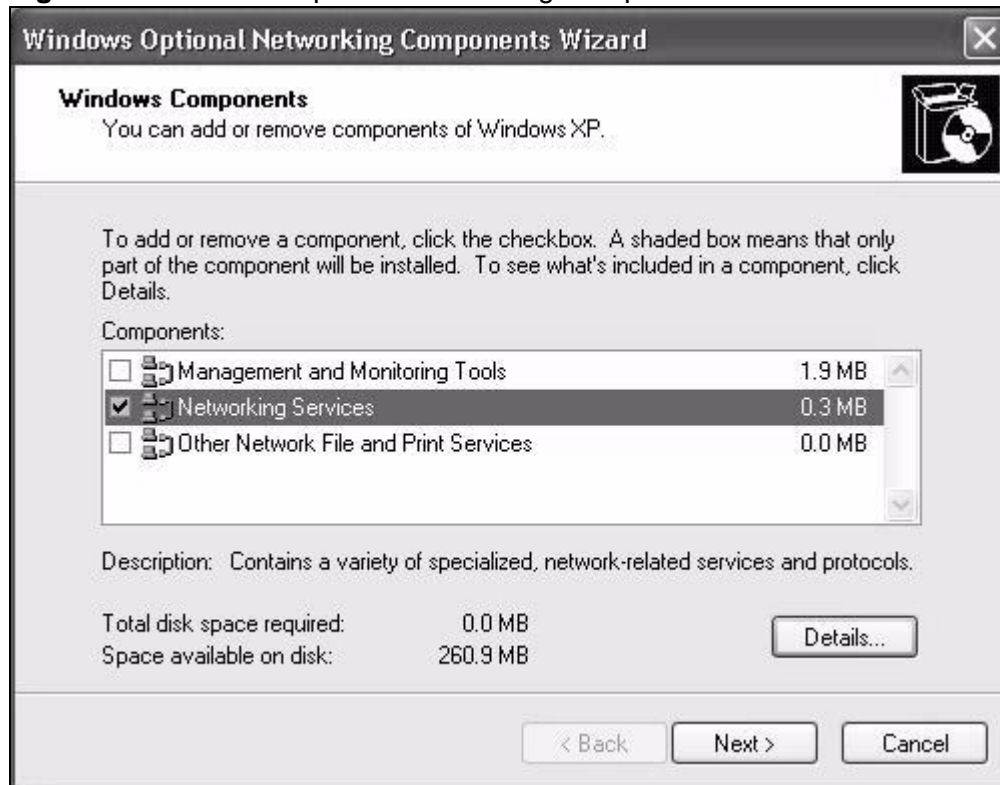

- 5 In the **Networking Services** window, select the **Universal Plug and Play** check box.

Figure 54 Networking Services

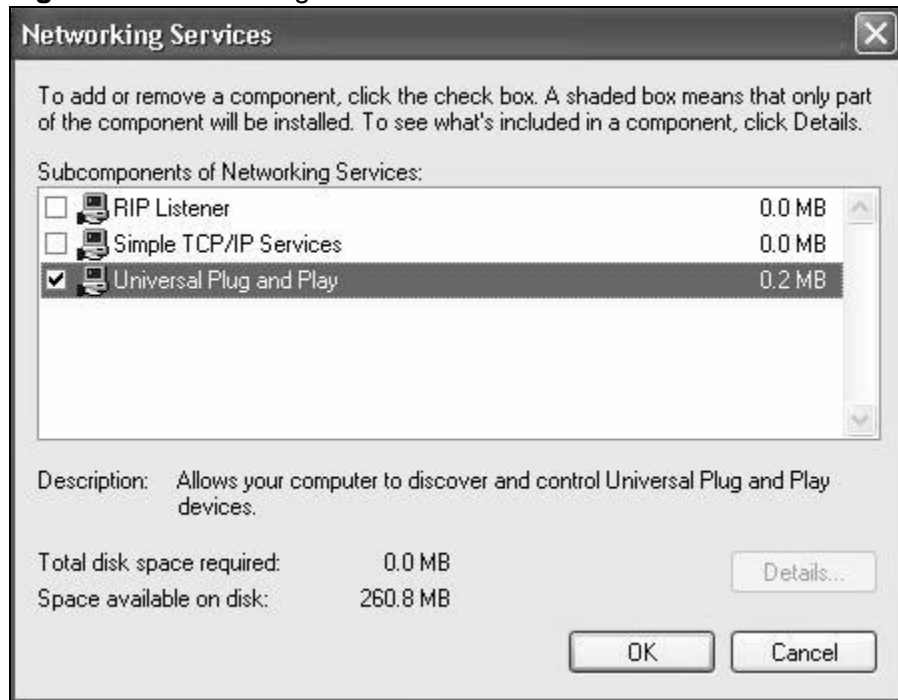

- 6 Click **OK** to go back to the **Windows Optional Networking Component Wizard** window and click **Next**.

7.10 Using UPnP in Windows XP Example

This section shows you how to use the UPnP feature in Windows XP. You must already have UPnP installed in Windows XP and UPnP activated on the ZyXEL Device.

Make sure the computer is connected to a LAN port of the ZyXEL Device. Turn on your computer and the ZyXEL Device.

Auto-discover Your UPnP-enabled Network Device

- 1 Click **Start** and **Control Panel**. Double-click **Network Connections**. An icon displays under Internet Gateway.

- 2 Right-click the icon and select **Properties**.

Figure 55 Network Connections



- 3 In the **Internet Connection Properties** window, click **Settings** to see the port mappings there were automatically created.

Figure 56 Internet Connection Properties



- You may edit or delete the port mappings or click **Add** to manually add port mappings.

Figure 57 Internet Connection Properties: Advanced Settings

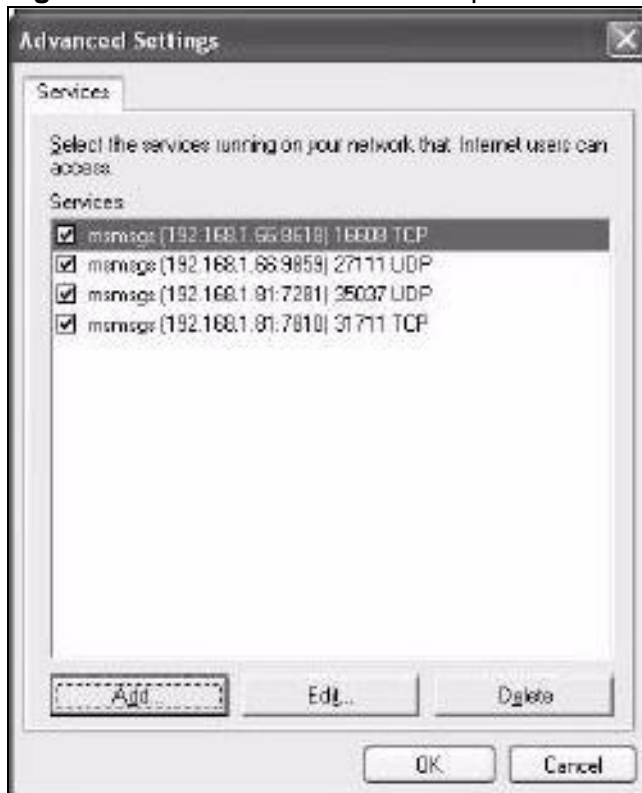
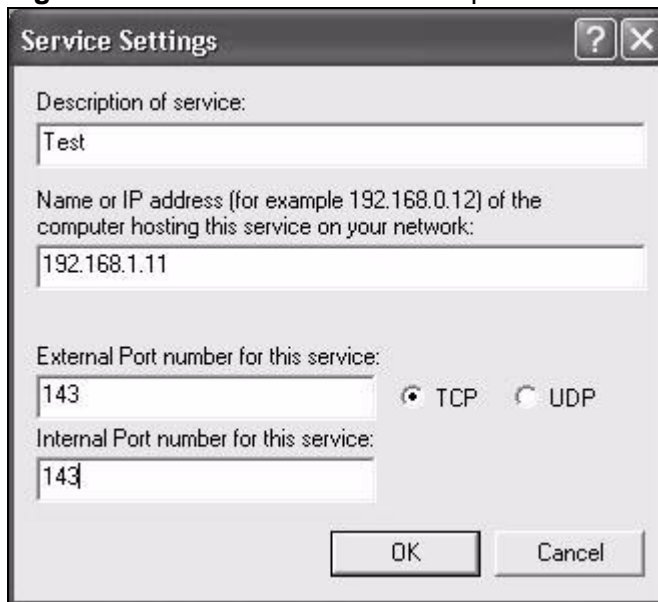

Figure 58 Internet Connection Properties: Advanced Settings: Add



- When the UPnP-enabled device is disconnected from your computer, all port mappings will be deleted automatically.

- 6 Select **Show icon in notification area when connected** option and click **OK**. An icon displays in the system tray.

Figure 59 System Tray Icon



- 7 Double-click on the icon to display your current Internet connection status.

Figure 60 Internet Connection Status

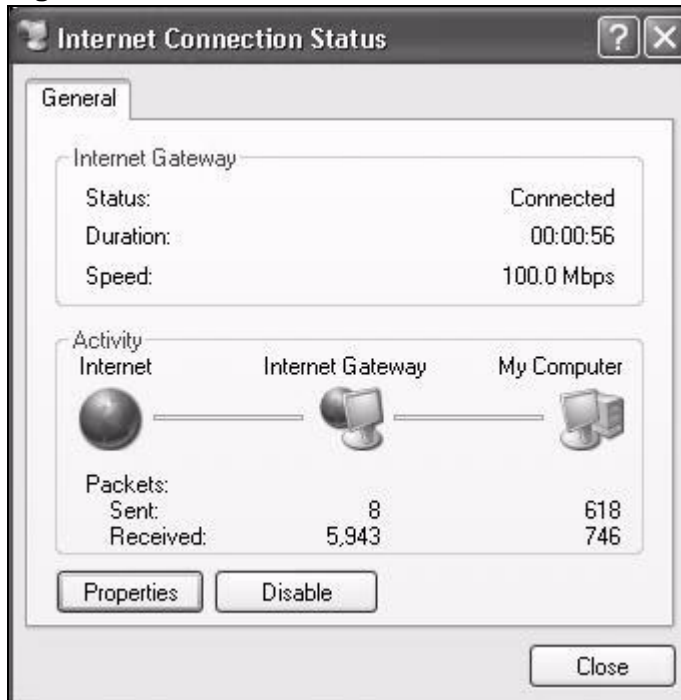

Web Configurator Easy Access

With UPnP, you can access the web-based configurator on the ZyXEL Device without finding out the IP address of the ZyXEL Device first. This comes helpful if you do not know the IP address of the ZyXEL Device.

Follow the steps below to access the web configurator.

- 1 Click **Start** and then **Control Panel**.
- 2 Double-click **Network Connections**.

- 3 Select **My Network Places** under **Other Places**.

Figure 61 Network Connections

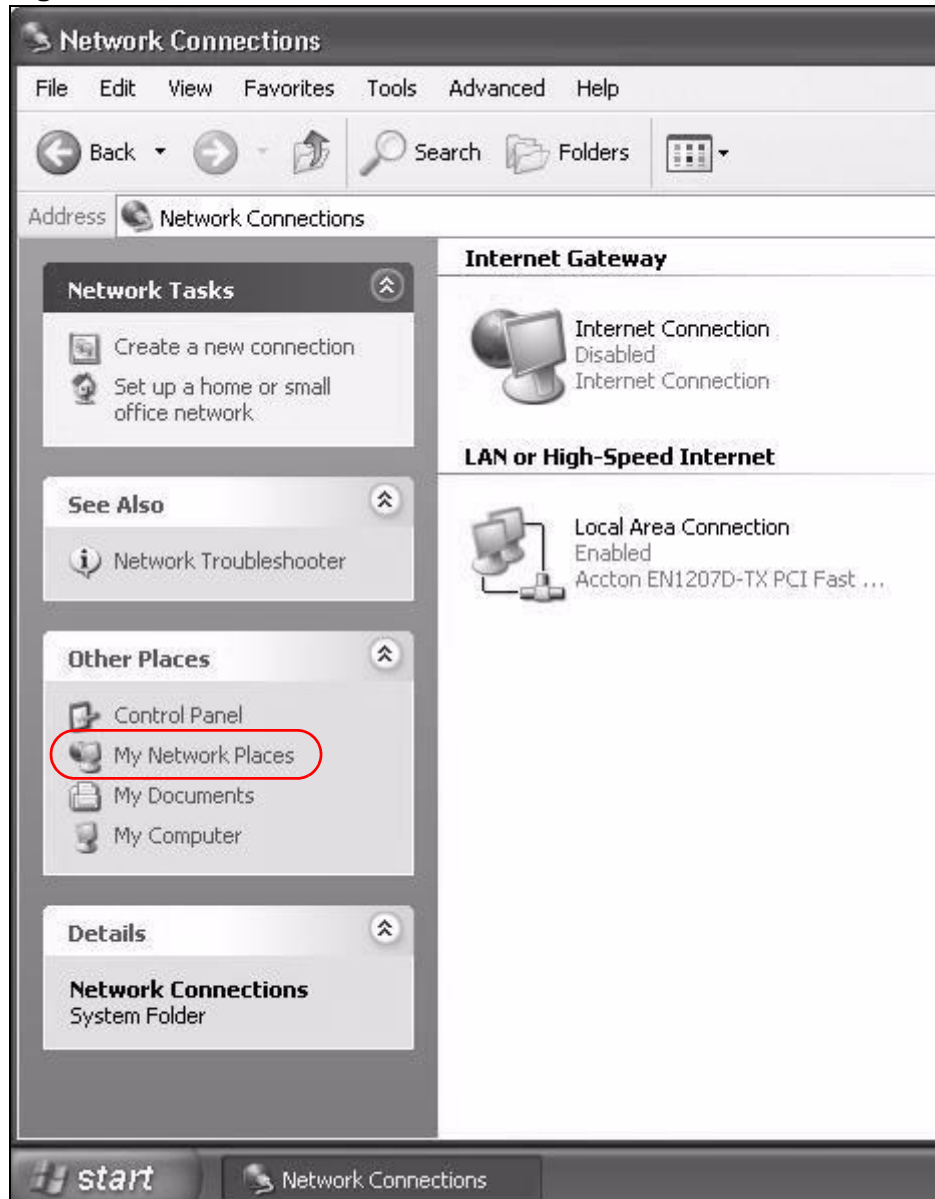

- 4 An icon with the description for each UPNP-enabled device displays under **Local Network**.

- 5 Right-click on the icon for your ZyXEL Device and select **Invoke**. The web configurator login screen displays.

Figure 62 Network Connections: My Network Places

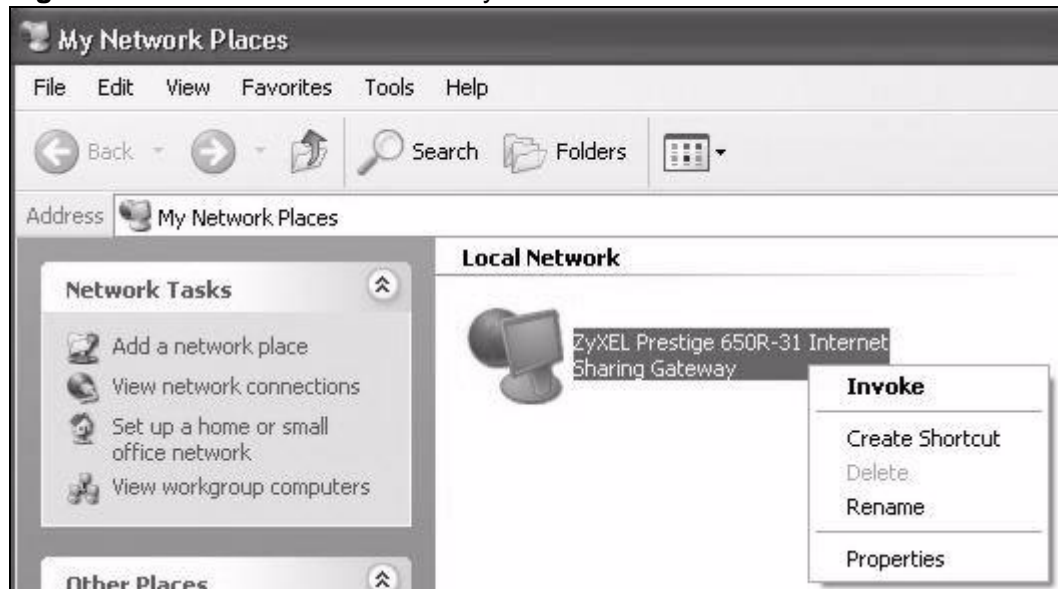

- 6 Right-click on the icon for your ZyXEL Device and select **Properties**. A properties window displays with basic information about the ZyXEL Device.

Figure 63 Network Connections: My Network Places: Properties: Example



Routing

8.1 Overview

The ZyXEL Device usually uses the default gateway to route outbound traffic from computers on the LAN to the Internet. To have the ZyXEL Device send data to devices not reachable through the default gateway, use static routes.

For example, the next figure shows a computer (**A**) connected to the ZyXEL Device's LAN interface. The ZyXEL Device routes most traffic from **A** to the Internet through the ZyXEL Device's default gateway (**R1**). You create one static route to connect to services offered by your ISP behind router **R2**. You create another static route to communicate with a separate network behind a router **R3** connected to the LAN.



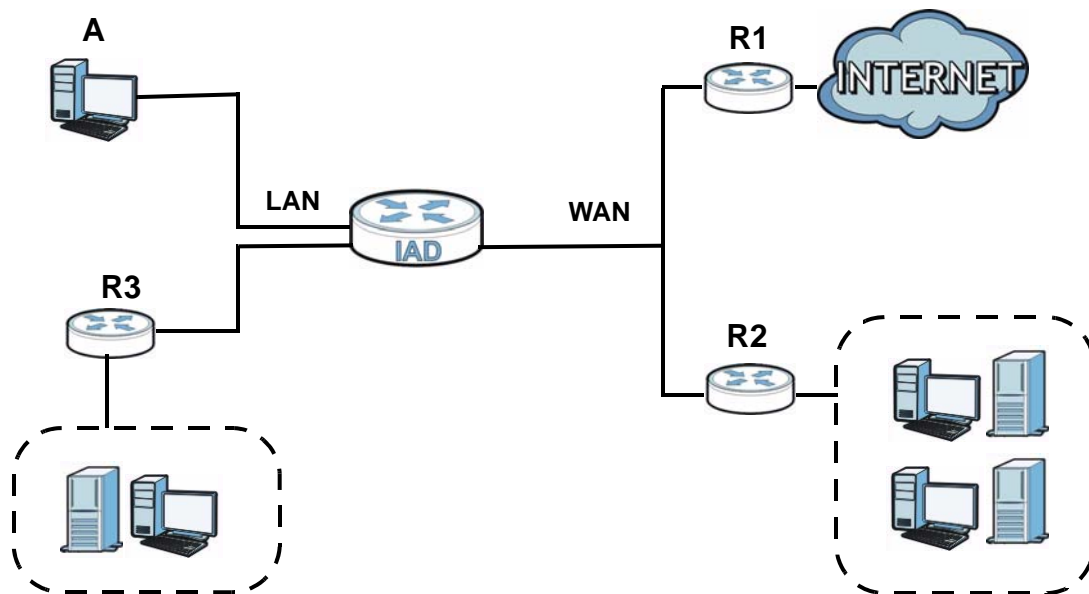

Figure 64 Example of Static Routing Topology



8.2 Configuring Static Route

Use this screen to view and configure IP static routes on the ZyXEL Device. Click **Network Setting > Routing** to open the following screen.

Figure 65 Network Setting > Routing

Add New Static Route								
#	Active	Status	Name	Destination IP	Gateway	Subnet Mask	Interface	Modify
1			test1	192.168.0.0		255.255.0.0	EtherWAN1	 

The following table describes the labels in this screen.

Table 34 Network Setting > Routing

LABEL	DESCRIPTION
Add New Static Route	Click this to set up a new static route on the ZyXEL Device.
#	This is the number of an individual static route.
Active	This indicates whether the rule is active or not. A yellow bulb signifies that this static route is active. A gray bulb signifies that this static route is not active.
Status	This shows whether the static route is currently in use or not. A yellow bulb signifies that this static route is in use. A gray bulb signifies that this static route is not in use.
Name	This is the name that describes or identifies this route.
Destination IP	This parameter specifies the IP network address of the final destination. Routing is always based on network number.
Gateway	This is the IP address of the gateway. The gateway is a router or switch on the same network segment as the device's LAN or WAN port. The gateway helps forward packets to their destinations.
Subnet Mask	This parameter specifies the IP network subnet mask of the final destination.
Interface	This is the WAN interface through which the traffic is routed.
Modify	Click the Edit icon to go to the screen where you can set up a static route on the ZyXEL Device. Click the Delete icon to remove a static route from the ZyXEL Device.

8.2.1 Add/Edit Static Route

Click **add new Static Route** in the **Routing** screen or click the **Edit** icon next to a rule. The following screen appears. Use this screen to configure the required information for a static route.

Figure 66 Routing: Add/Edit

Active

Route Name :

Destination IP Address :

IP Subnet Mask :

Gateway IP Address :

Bound Interface NotAvailable ▾

Note :

The Destination IP Address and IP Subnet Mask fields must be matched; e.g. host/255.255.255.255 or subnet/255.255.255.0.

Apply Back

The following table describes the labels in this screen.

Table 35 Routing: Add/Edit

LABEL	DESCRIPTION
Active	Click this to activate this static route.
Route Name	Enter the name of the IP static route. Leave this field blank to delete this static route.
Destination IP Address	This parameter specifies the IP network address of the final destination. Routing is always based on network number. If you need to specify a route to a single host, use a subnet mask of 255.255.255.255 in the subnet mask field to force the network number to be identical to the host ID.
IP Subnet Mask	Enter the IP subnet mask here.
Gateway IP Address	You can decide if you want to forward packets to a gateway IP address or a bound interface. If you want to configure Gateway IP Address , enter the IP address of the next-hop gateway. The gateway is a router or switch on the same network segment as the device's LAN or WAN port. The gateway helps forward packets to their destinations.
Bound Interface	You can decide if you want to forward packets to a gateway IP address or a bound interface. If you want to configure Bound Interface , select the check box and choose an interface through which the traffic is sent. You must have the WAN interface(s) already configured in the Broadband screen.
Apply	Click Apply to save your changes.
Back	Click Back to exit this screen without saving.

DNS Route

9.1 Overview

DNS (Domain Name System) is for mapping a domain name to its corresponding IP address and vice versa. The DNS server is extremely important because without it, you must know the IP address of a machine before you can access it.

In addition to the system DNS server(s), each WAN interface (service) is set to have its own static or dynamic DNS server list. You can configure a DNS static route to forward DNS queries for certain domain names through a specific WAN interface to its DNS server(s). The ZyXEL Device uses a system DNS server (in the order you specify in the **Broadband** screen) to resolve domain names that do not match any DNS routing entry. After the ZyXEL Device receives a DNS reply from a DNS server, it creates a new entry for the resolved IP address in the routing table.

In the following example, the DNS server 168.92.5.1 obtained from the WAN interface ptm0.100 is set to be the system DNS server. The DNS server 10.10.23.7 is obtained from the WAN interface ppp1.123. You configure a DNS route for *example.com to have the ZyXEL Device forward DNS requests for the domain name mail.example.com through the WAN interface ppp1.123 to the DNS server 10.10.23.7.

Figure 67 Example of DNS Routing Topology

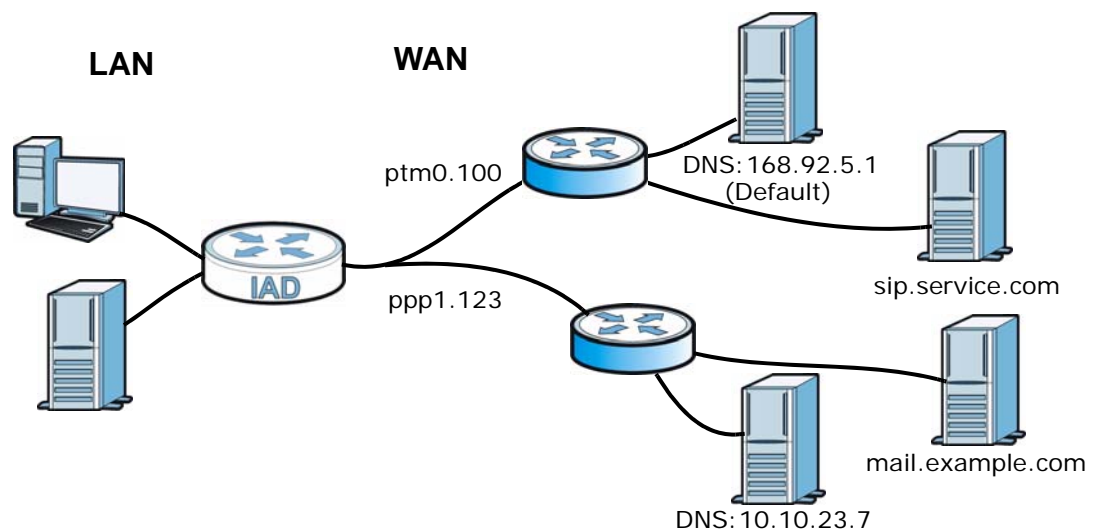

9.1.1 What You Can Do in this Chapter

The **DNS Route** screens let you view and configure DNS routes on the ZyXEL Device ([Section 9.2 on page 186](#)).

9.2 The DNS Route Screen

The **DNS Route** screens let you view and configure DNS routes on the ZyXEL Device. Click **Network Setting > DNS Route** to open the **DNS Route** screen.

Figure 68 Network Setting > DNS Route

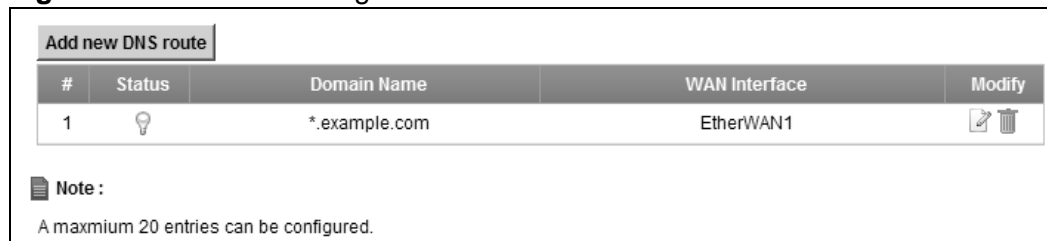

The following table describes the labels in this screen.

Table 36 Network Setting > DNS Route

LABEL	DESCRIPTION
Add new DNS route	Click this to create a new entry.
#	This is the number of an individual DNS route.
Status	This shows whether the DNS route is currently in use or not. A yellow bulb signifies that this DNS route is in use. A gray bulb signifies that this DNS route is not in use.
Domain Name	This is the domain name to which the DNS route applies.
WAN Interface	This is the WAN interface through which the matched DNS request is routed.
Modify	Click the Edit icon to configure a DNS route on the ZyXEL Device. Click the Delete icon to remove a DNS route from the ZyXEL Device.

9.2.1 Add/Edit DNS Route Edit

Click **Add new DNS route** in the **DNS Route** screen or the **Edit** icon next to an existing DNS route. Use this screen to configure the required information for a DNS route.

Figure 69 DNS Route: Add/Edit

The following table describes the labels in this screen.

Table 37 DNS Route: Add/Edit

LABEL	DESCRIPTION
Active	Select this to activate this DNS route.
Domain Name	Enter the domain name you want to resolve. You can use the wildcard character, an "*" (asterisk) as the left most part of a domain name, such as *.example.com. The ZyXEL Device forwards DNS queries for any domain name ending in example.com to the WAN interface specified in this route.
WAN Interface	Select a WAN interface through which the matched DNS query is sent. You must have the WAN interface(s) already configured in the Broadband screen.
Apply	Click Apply to save your changes.
Back	Click Back to exit this screen without saving.

Quality of Service (QoS)

10.1 Overview

This chapter discusses the ZyXEL Device's **QoS** screens. Use these screens to set up your ZyXEL Device to use QoS for traffic management.

Quality of Service (QoS) refers to both a network's ability to deliver data with minimum delay, and the networking methods used to control the use of bandwidth. QoS allows the ZyXEL Device to group and prioritize application traffic and fine-tune network performance.

Without QoS, all traffic data is equally likely to be dropped when the network is congested. This can cause a reduction in network performance and make the network inadequate for time-critical application such as video-on-demand.

The ZyXEL Device assigns each packet a priority and then queues the packet accordingly. Packets assigned a high priority are processed more quickly than those with low priority if there is congestion, allowing time-sensitive applications to flow more smoothly. Time-sensitive applications include both those that require a low level of latency (delay) and a low level of jitter (variations in delay) such as Internet gaming, and those for which jitter alone is a problem such as Internet radio or streaming video.

Note: The ZyXEL Device has built-in configurations for Voice over IP (IP). The Quality of Service (QoS) feature does not affect VoIP traffic.

- See [Section 10.6 on page 199](#) for advanced technical information on SIP.

10.1.1 What You Can Do in this Chapter

- Use the **General** screen to enable QoS, set the bandwidth, and allow the ZyXEL Device to automatically assign priority to upstream traffic according to the IEEE 802.1p priority level, IP precedence or packet length ([Section 10.2 on page 190](#)).
- Use the **Queue Setup** screen to configure QoS queue assignment ([Section 10.3 on page 192](#)).

- Use the **Class Setup** screen to set up classifiers to sort traffic into different flows and assign priority and define actions to be performed for a classified traffic flow ([Section 10.4 on page 194](#)).
- Use the **Monitor** screen to view the ZyXEL Device's QoS-related packet statistics ([Section 10.5 on page 198](#)).

10.1.2 What You Need to Know

The following terms and concepts may help as you read this chapter.

QoS versus Cos

QoS is used to prioritize source-to-destination traffic flows. All packets in the same flow are given the same priority. CoS (class of service) is a way of managing traffic in a network by grouping similar types of traffic together and treating each type as a class. You can use CoS to give different priorities to different packet types.

CoS technologies include IEEE 802.1p layer 2 tagging and DiffServ (Differentiated Services or DS). IEEE 802.1p tagging makes use of three bits in the packet header, while DiffServ is a new protocol and defines a new DS field, which replaces the eight-bit ToS (Type of Service) field in the IP header.

Tagging and Marking

In a QoS class, you can configure whether to add or change the DSCP (DiffServ Code Point) value, IEEE 802.1p priority level and VLAN ID number in a matched packet. When the packet passes through a compatible network, the networking device, such as a backbone switch, can provide specific treatment or service based on the tag or marker.

10.2 The QoS General Screen

Use this screen to enable or disable QoS, set the bandwidth, and select to have the ZyXEL Device automatically assign priority to upstream traffic according to the IEEE 802.1p priority level, IP precedence or packet length.

Click **Network Setting > QoS** to open the **General** screen.

Figure 70 Network Setting > QoS > General

Active QoS

WAN Managed Upstream Bandwidth : (kbps)

Traffic priority will be automatically assigned by

Note :

You can assign the upstream bandwidth manually.
 If the field is empty, the CPE set the value automatically.
 If Enable QoS checkbox is selected, choose an automapping type to assign traffic priority automatically.

The following table describes the labels in this screen.

Table 38 Network Setting > QoS > General

LABEL	DESCRIPTION
Active QoS	Select the check box to turn on QoS to improve your network performance. You can give priority to traffic that the ZyXEL Device forwards out through the WAN interface. Give high priority to voice and video to make them run more smoothly. Similarly, give low priority to many large file downloads so that they do not reduce the quality of other applications.
WAN Managed Upstream Bandwidth	Enter the amount of bandwidth for the WAN interface that you want to allocate using QoS. The recommendation is to set this speed to match the interface's actual transmission speed. For example, set the WAN interface speed to 100000 kbps if your Internet connection has an upstream transmission speed of 100 Mbps. Setting this number higher than the interface's actual transmission speed will stop lower priority traffic from being sent if higher priority traffic uses all of the actual bandwidth. If you set this number lower than the interface's actual transmission speed, the ZyXEL Device will not use some of the interface's available bandwidth. Leave this field blank to have the ZyXEL Device set this value automatically.
Traffic priority will be automatically assigned by	These fields are ignored if upstream traffic matches a class you configured in the Class Setup screen. If you select Ethernet Priority , IP Precedence or Packet Length and traffic does not match a class configured in the Class Setup screen, the ZyXEL Device assigns priority to unmatched traffic based on the IEEE 802.1p priority level, IP precedence or packet length. See Section 10.6.1 on page 199 for more information.

Table 38 Network Setting > QoS > General

LABEL	DESCRIPTION
Apply	Click Apply to save your changes.
Cancel	Click Cancel to restore your previously saved settings.

10.3 The Queue Setup Screen

Use this screen to configure QoS queue assignment. Click **Network Setting > QoS > Queue Setup** to open the screen as shown next.

Figure 71 Network Setting > QoS > Queue Setup

The screenshot shows a web interface for configuring QoS queues. At the top left is a button labeled "Add new Queue". Below it is a table with the following columns: #, Status, Name, Interface, Priority, Weight, Buffer Management, Rate Limit (Kbps), and Modify. There is one row in the table with the following values: # 1, Status checked, Name Default_Queue, Interface WAN, Priority 4, Weight 1, Buffer Management DT, and Modify icons (edit and delete). Below the table is a "Note" section with a document icon and the text: "Maximum 8 configurable entries for WAN port except default queue." At the bottom right are "Apply" and "Cancel" buttons.

#	Status	Name	Interface	Priority	Weight	Buffer Management	Rate Limit (Kbps)	Modify
1	<input checked="" type="checkbox"/>	Default_Queue	WAN	4	1	DT		

Note :
Maximum 8 configurable entries for WAN port except default queue.

Apply Cancel

The following table describes the labels in this screen.

Table 39 Network Setting > QoS > Queue Setup

LABEL	DESCRIPTION
Add new Queue	Click this to create a new entry.
#	This is the index number of this entry.
Status	Select the check box to enable the queue.
Name	This shows the descriptive name of this queue.
Interface	This shows the name of the ZyXEL Device's interface through which traffic in this queue passes.
Priority	This shows the priority of this queue.
Weight	This shows the weight of this queue.
Buffer Management	This shows the queue management algorithm used by the ZyXEL Device.
Rate Limit (kbps)	This shows the maximum transmission rate allowed for traffic on this queue.
Modify	Click the Edit icon to edit the queue. Click the Delete icon to delete an existing queue. Note that subsequent rules move up by one when you take this action.

Table 39 Network Setting > QoS > Queue Setup (continued)

LABEL	DESCRIPTION
Apply	Click Apply to save your changes.
Cancel	Click Cancel to restore your previously saved settings.

10.3.1 Add/Edit a QoS Queue

Use this screen to configure a queue. Click **Add new queue** in the **Queue Setup** screen or the **Edit** icon next to an existing queue.

Figure 72 Queue Setup: Add/Edit

The following table describes the labels in this screen.

Table 40 Queue Setup: Add/Edit

LABEL	DESCRIPTION
Active	Select to enable or disable this queue.
Name	Enter the descriptive name of this queue.
Priority	Select the priority level (from 1 to 7) of this queue. The larger the number, the higher the priority level. Traffic assigned to higher priority queues gets through faster while traffic in lower priority queues is dropped if the network is congested.
Weight	Select the weight (from 1 to 15) of this queue. If two queues have the same priority level, the ZyXEL Device divides the bandwidth across the queues according to their weights. Queues with larger weights get more bandwidth than queues with smaller weights.
Rate Limit	Specify the maximum transmission rate (in Kbps) allowed for traffic on this queue.
Apply	Click Apply to save your changes.
Back	Click Back to return to the previous screen without saving.

10.4 The Class Setup Screen

Use this screen to add, edit or delete QoS classifiers. A classifier groups traffic into data flows according to specific criteria such as the source address, destination address, source port number, destination port number or incoming interface. For example, you can configure a classifier to select traffic from the same protocol port (such as Telnet) to form a flow.

You can give different priorities to traffic that the ZyXEL Device forwards out through the WAN interface. Give high priority to voice and video to make them run more smoothly. Similarly, give low priority to many large file downloads so that they do not reduce the quality of other applications.

Click **Network Setting > QoS > Class Setup** to open the following screen.

Figure 73 Network Setting > QoS > Class Setup

Order	Status	Class Name	Classification Criteria	Forward to	DSCP Mark	To Queue	Modify
1	<input checked="" type="checkbox"/>	Example_1		AdslWAN1	UnChange	Default_Queue	

The following table describes the labels in this screen.

Table 41 Network Setting > QoS > Class Setup

LABEL	DESCRIPTION
Add new Classifier	Click this to create a new classifier.
Order	This field displays the order number of the classifier.
Status	Select the check box to enable the classifier.
Class Name	This is the name of the classifier.
Classification Criteria	This shows criteria specified in this classifier, for example the interface from which traffic of this class should come and the source MAC address of traffic that matches this classifier.
Forward to	This is the interface through which traffic that matches this classifier is forwarded out.
DSCP Mark	This is the DSCP number added to traffic of this classifier.
To Queue	This is the name of the queue in which traffic of this classifier is put.
Modify	Click the Edit icon to edit the classifier. Click the Delete icon to delete an existing classifier. Note that subsequent rules move up by one when you take this action.
Apply	Click Apply to save your changes.
Cancel	Click Cancel to restore your previously saved settings.

10.4.1 Add/Edit QoS Class

Click **Add new Classifier** in the **Class Setup** screen or the **Edit** icon next to an existing classifier to configure it.

Figure 74 Class Setup: Add/Edit

Class Configuration

Active :

Class Name :

Classification Order :

Forward To Interface :

DSCP Mark : (0~63)

To Queue :

Criteria Configuration

Use the configurations below to specify the characteristics of a data flow need to be managed by this QoS rule

- **Basic**
 - From Interface
 - Ether Type
- **Source**
 - MAC Address MAC Mask Exclude
 - IP Address IP Subnet Mask Exclude
 - Port Range ~ (1~65535) Exclude
- **Destination**
 - MAC Address MAC Mask Exclude
 - IP Address IP Subnet Mask Exclude
 - Port Range ~ (1~65535) Exclude
- **Others**
 - IP Protocol Exclude
 - IP Packet Length ~ (46~1504) Exclude
 - DSCP Exclude
 - TCP ACK Exclude
 - DHCP Exclude
 - Class ID (String)
 - Service Exclude

The following table describes the labels in this screen.

Table 42 Class Setup: Add/Edit

LABEL	DESCRIPTION
Class Configuration	
Active	Select to enable this classifier.
Class Name	Enter a descriptive name of up to 32 printable English keyboard characters, including spaces.

Table 42 Class Setup: Add/Edit (continued)

LABEL	DESCRIPTION
Classification Order	Select an existing number for where you want to put this classifier to move the classifier to the number you selected after clicking Apply . Select Last to put this rule in the back of the classifier list.
Forward to Interface	Select a WAN interface through which traffic of this class will be forwarded out. If you select Unchange , the ZyXEL Device forward traffic of this class according to the default routing table.
DSCP Mark	This field is available only when you select the Ether Type check box in Criteria Configuration-Basic section. If you select Mark , enter a DSCP value with which the ZyXEL Device replaces the DSCP field in the packets. If you select Unchange , the ZyXEL Device keep the DSCP field in the packets.
To Queue	Select a queue that applies to this class. You should have configured a queue in the Queue Setup screen already.
Criteria Configuration	
Use the following fields to configure the criteria for traffic classification.	
Basic	
From Interface	Select whether the traffic class comes from the LAN or a wireless interface.
Ether Type	Select a predefined application to configure a class for the matched traffic. If you select IP , you also need to configure source or destination MAC address, IP address, DHCP options, DSCP value or the protocol type. If you select 8021Q , you can configure an 802.1p priority level and VLAN ID in the Others section.
Source	
MAC Address	Select the check box and enter the source MAC address of the packet.
MAC Mask	Type the mask for the specified MAC address to determine which bits a packet's MAC address should match. Enter "f" for each bit of the specified source MAC address that the traffic's MAC address should match. Enter "0" for the bit(s) of the matched traffic's MAC address, which can be of any hexadecimal character(s). For example, if you set the MAC address to 00:13:49:00:00:00 and the mask to ff:ff:ff:00:00:00, a packet with a MAC address of 00:13:49:12:34:56 matches this criteria.
IP Address	Select the check box and enter the source IP address in dotted decimal notation. A blank source IP address means any source IP address.
IP Subnet Mask	Enter the source subnet mask.
Port Range	If you select TCP or UDP in the IP Protocol field, select the check box and enter the port number(s) of the source.

Table 42 Class Setup: Add/Edit (continued)

LABEL	DESCRIPTION
Exclude	Select this option to exclude the packets that match the specified criteria from this classifier.
Destination	
MAC Address	Select the check box and enter the destination MAC address of the packet.
MAC Mask	<p>Type the mask for the specified MAC address to determine which bits a packet's MAC address should match.</p> <p>Enter "f" for each bit of the specified source MAC address that the traffic's MAC address should match. Enter "0" for the bit(s) of the matched traffic's MAC address, which can be of any hexadecimal character(s). For example, if you set the MAC address to 00:13:49:00:00:00 and the mask to ff:ff:ff:00:00:00, a packet with a MAC address of 00:13:49:12:34:56 matches this criteria.</p>
IP Address	Select the check box and enter the destination IP address in dotted decimal notation. A blank source IP address means any source IP address.
IP Subnet Mask	Enter the destination subnet mask.
Port Range	If you select TCP or UDP in the IP Protocol field, select the check box and enter the port number(s) of the source.
Exclude	Select this option to exclude the packets that match the specified criteria from this classifier.
Others	
IP Protocol	<p>This field is available only when you select IP in the Ether Type field.</p> <p>Select this option and select the protocol (service type) from TCP or UDP. If you select User defined, enter the protocol (service type) number.</p>
IP Packet Length	<p>This field is available only when you select IP in the Ether Type field.</p> <p>Select this option and enter the minimum and maximum packet length (from 46 to 1504) in the fields provided.</p>
DSCP	<p>This field is available only when you select IP in the Ether Type field.</p> <p>Select this option and specify a DSCP (DiffServ Code Point) number between 0 and 63 in the field provided.</p>
TCP ACK	<p>This field is available only when you select IP in the Ether Type field.</p> <p>If you select this option, the matched TCP packets must contain the ACK (Acknowledge) flag.</p>

Table 42 Class Setup: Add/Edit (continued)

LABEL	DESCRIPTION
DHCP	<p>This field is available only when you select IP in the Ether Type field, and UDP in the IP Protocol field.</p> <p>Select this option and select a DHCP option.</p> <p>If you select Vendor Class ID (DHCP Option 60), enter the Class ID of the matched traffic, such as the type of the hardware or firmware.</p> <p>If you select ClientID (DHCP Option 61), enter the Type of the matched traffic and Client ID of the DHCP client.</p> <p>If you select User Class ID (DHCP Option 77), enter the User Class Data, which is a string that identifies the user's category or application type in the matched DHCP packets.</p> <p>If you select VendorSpecificIntro (DHCP Option 125), enter the Enterprise Number of the software of the matched traffic and Vendor Class Data used by all the DHCP clients.</p>
Service	Select the service classification of the traffic.
Exclude	Select this option to exclude the packets that match the specified criteria from this classifier.
Apply	Click Apply to save your changes.
Back	Click Back to return to the previous screen without saving.

10.5 The QoS Monitor Screen

To view the ZyXEL Device's QoS packet statistics, click **Network Setting > QoS > Monitor**. The screen appears as shown.

Figure 75 Network Setting > QoS > Monitor

Monitor			
Refresh Interval :	No Refresh ▾		
Status :			
▪ Interface Monitor			
#	Name	Pass Rate(bps)	
1	nas1	0	
▪ Queue Monitor			
#	Name	Pass Rate(bps)	Drop Rate(bps)
1	Default_Queue	0	0

The following table describes the labels in this screen.

Table 43 Network Setting > QoS > Monitor

LABEL	DESCRIPTION
Monitor	
Refresh Interval	Select how often you want the ZyXEL Device to update this screen. Select No Refresh to stop refreshing statistics.
Status	
#	This is the index number of the entry.
Name	This shows the name of the WAN interface on the ZyXEL Device.
Pass Rate (bps)	This shows how many packets forwarded to this interface are transmitted successfully.
Queue Monitor	
#	This is the index number of the entry.
Name	This shows the name of the queue.
Pass Rate (bps)	This shows how many packets assigned to this queue are transmitted successfully.
Drop Rate (bps)	This shows how many packets assigned to this queue are dropped.

10.6 QoS Technical Reference

This section provides some technical background information about the topics covered in this chapter.

10.6.1 IEEE 802.1Q Tag

The IEEE 802.1Q standard defines an explicit VLAN tag in the MAC header to identify the VLAN membership of a frame across bridges. A VLAN tag includes the 12-bit VLAN ID and 3-bit user priority. The VLAN ID associates a frame with a specific VLAN and provides the information that devices need to process the frame across the network.

IEEE 802.1p specifies the user priority field and defines up to eight separate traffic types. The following table describes the traffic types defined in the IEEE 802.1d standard (which incorporates the 802.1p).

Table 44 IEEE 802.1p Priority Level and Traffic Type

PRIORITY LEVEL	TRAFFIC TYPE
Level 7	Typically used for network control traffic such as router configuration messages.
Level 6	Typically used for voice traffic that is especially sensitive to jitter (jitter is the variations in delay).

Table 44 IEEE 802.1p Priority Level and Traffic Type

PRIORITY LEVEL	TRAFFIC TYPE
Level 5	Typically used for video that consumes high bandwidth and is sensitive to jitter.
Level 4	Typically used for controlled load, latency-sensitive traffic such as SNA (Systems Network Architecture) transactions.
Level 3	Typically used for “excellent effort” or better than best effort and would include important business traffic that can tolerate some delay.
Level 2	This is for “spare bandwidth”.
Level 1	This is typically used for non-critical “background” traffic such as bulk transfers that are allowed but that should not affect other applications and users.
Level 0	Typically used for best-effort traffic.

10.6.2 IP Precedence

Similar to IEEE 802.1p prioritization at layer-2, you can use IP precedence to prioritize packets in a layer-3 network. IP precedence uses three bits of the eight-bit ToS (Type of Service) field in the IP header. There are eight classes of services (ranging from zero to seven) in IP precedence. Zero is the lowest priority level and seven is the highest.

10.6.3 DiffServ

QoS is used to prioritize source-to-destination traffic flows. All packets in the flow are given the same priority. You can use CoS (class of service) to give different priorities to different packet types.

DiffServ (Differentiated Services) is a class of service (CoS) model that marks packets so that they receive specific per-hop treatment at DiffServ-compliant network devices along the route based on the application types and traffic flow. Packets are marked with DiffServ Code Points (DSCPs) indicating the level of service desired. This allows the intermediary DiffServ-compliant network devices to handle the packets differently depending on the code points without the need to negotiate paths or remember state information for every flow. In addition, applications do not have to request a particular service or give advanced notice of where the traffic is going.

DSCP and Per-Hop Behavior

DiffServ defines a new DS (Differentiated Services) field to replace the Type of Service (TOS) field in the IP header. The DS field contains a 2-bit unused field and a 6-bit DSCP field which can define up to 64 service levels. The following figure illustrates the DS field.

DSCP is backward compatible with the three precedence bits in the ToS octet so that non-DiffServ compliant, ToS-enabled network device will not conflict with the DSCP mapping.

DSCP (6 bits)	Unused (2 bits)
---------------	-----------------

The DSCP value determines the forwarding behavior, the PHB (Per-Hop Behavior), that each packet gets across the DiffServ network. Based on the marking rule, different kinds of traffic can be marked for different kinds of forwarding. Resources can then be allocated according to the DSCP values and the configured policies.

Network Address Translation (NAT)

11.1 Overview

NAT (Network Address Translation - NAT, RFC 1631) is the translation of the IP address of a host in a packet, for example, the source address of an outgoing packet, used within one network to a different IP address known within another network.

11.1.1 What You Can Do in this Chapter

- Use the **Port Forwarding** screen to configure forward incoming service requests to the server(s) on your local network ([Section 11.2 on page 204](#)).
- Use the **Sessions** screen to limit the number of concurrent NAT sessions each client can use ([Section 11.3 on page 207](#)).

11.1.2 What You Need To Know

The following terms and concepts may help as you read this chapter.

Inside/Outside and Global/Local

Inside/outside denotes where a host is located relative to the ZyXEL Device, for example, the computers of your subscribers are the inside hosts, while the web servers on the Internet are the outside hosts.

Global/local denotes the IP address of a host in a packet as the packet traverses a router, for example, the local address refers to the IP address of a host when the packet is in the local network, while the global address refers to the IP address of the host when the same packet is traveling in the WAN side.

NAT

In the simplest form, NAT changes the source IP address in a packet received from a subscriber (the inside local address) to another (the inside global address)

before forwarding the packet to the WAN side. When the response comes back, NAT translates the destination address (the inside global address) back to the inside local address before forwarding it to the original inside host.

Port Forwarding

A port forwarding set is a list of inside (behind NAT on the LAN) servers, for example, web or FTP, that you can make visible to the outside world even though NAT makes your whole inside network appear as a single computer to the outside world.

Finding Out More

See [Section 11.4 on page 208](#) for advanced technical information on NAT.

11.2 The Port Forwarding Screen

Use the **Port Forwarding** screen to forward incoming service requests to the server(s) on your local network.

You may enter a single port number or a range of port numbers to be forwarded, and the local IP address of the desired server. The port number identifies a service; for example, web service is on port 80 and FTP on port 21. In some cases, such as for unknown services or where one server can support more than one service (for example both FTP and web service), it might be better to specify a range of port numbers. You can allocate a server IP address that corresponds to a port or a range of ports.

The most often used port numbers and services are shown in [Appendix E on page 387](#). Please refer to RFC 1700 for further information about port numbers.

Note: Many residential broadband ISP accounts do not allow you to run any server processes (such as a Web or FTP server) from your location. Your ISP may periodically check for servers and may suspend your account if it discovers any active services at your location. If you are unsure, refer to your ISP.

Configuring Servers Behind Port Forwarding (Example)

Let's say you want to assign ports 21-25 to one FTP, Telnet and SMTP server (**A** in the example), port 80 to another (**B** in the example) and assign a default server IP address of 192.168.1.35 to a third (**C** in the example). You assign the LAN IP

addresses and the ISP assigns the WAN IP address. The NAT network appears as a single host on the Internet.

Figure 76 Multiple Servers Behind NAT Example

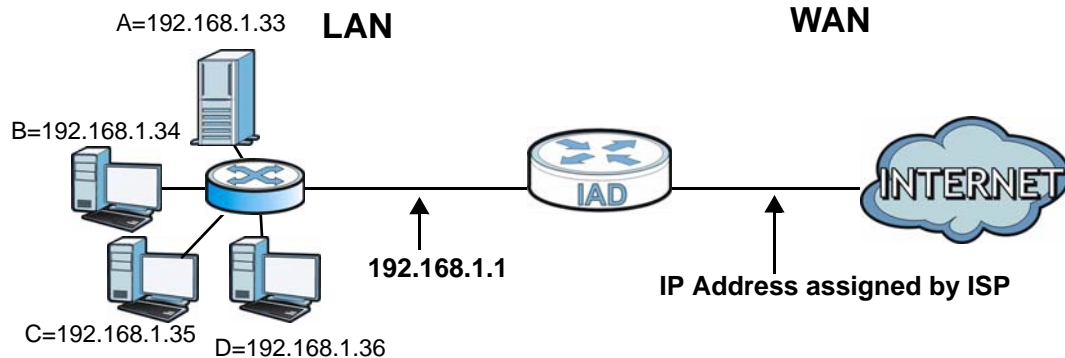

11.2.1 The Port Forwarding Screen

Click **Network Setting > NAT** to open the **Port Forwarding** screen.

See [Appendix E on page 387](#) for port numbers commonly used for particular services.

Figure 77 Network Setting > NAT > Port Forwarding

#	Status	ServiceName	WAN Interface	Start Port	End Port	Translation Start Port	Translation End Port	Server IP Address	Protocol	Modify
1	<input checked="" type="checkbox"/>	User Defined	EtherWAN1	21	21	21	21	192.13.56.32	TCP	

The following table describes the fields in this screen.

Table 45 Network Setting > NAT > Port Forwarding

LABEL	DESCRIPTION
Add new rule	Click this to add a new port forwarding rule.
#	This is the index number of the entry.
Status	This field indicates whether the rule is active or not. Clear the check box to disable the rule. Select the check box to enable it.
Service Name	This is the service's name. This shows User Defined if you manually added a service. You can change this by clicking the edit icon.
WAN Interface	This shows the WAN interface through which the service is forwarded.
Start Port	This is the first external port number that identifies a service.
End Port	This is the last external port number that identifies a service.

Table 45 Network Setting > NAT > Port Forwarding (continued)

LABEL	DESCRIPTION
Translation Start Port	This is the first internal port number that identifies a service.
Translation End Port	This is the last internal port number that identifies a service.
Server IP Address	This is the server's IP address.
Protocol	This shows the IP protocol supported by this virtual server, whether it is TCP , UDP , or TCP/UDP .
Modify	Click the Edit icon to edit the port forwarding rule. Click the Delete icon to delete an existing port forwarding rule. Note that subsequent address mapping rules move up by one when you take this action.
Apply	Click Apply to save your changes.
Cancel	Click Cancel to restore your previously saved settings.

11.2.2 The Port Forwarding Edit Screen

This screen lets you create or edit a port forwarding rule. Click **Add new rule** in the **Port Forwarding** screen or the **Edit** icon next to an existing rule to open the following screen.

Figure 78 Port Forwarding: Add/Edit

The screenshot shows a configuration window for port forwarding. It has a light gray background and a white border. The fields are arranged vertically on the left side, each with a label and a corresponding input field. The input fields are: a text box for 'Service Name' containing 'User Defined', a dropdown menu for 'WAN Interface' showing 'EtherWAN1', and text boxes for 'Start Port', 'End Port', 'Translation Start Port', and 'Translation End Port', all containing the number '21'. Below these is a text box for 'Server IP Address' containing '192.13.56.32' and a dropdown menu for 'Protocol' showing 'TCP'. At the bottom right of the window are two buttons: 'Apply' and 'Back'.

The following table describes the labels in this screen.

Table 46 Port Forwarding: Add/Edit

LABEL	DESCRIPTION
Service Name	Enter a name to identify this rule using keyboard characters (A-Z, a-z, 1-2 and so on).
WAN Interface	Select the WAN interface through which the service is forwarded. You must have already configured a WAN connection with NAT enabled.

Table 46 Port Forwarding: Add/Edit (continued)

LABEL	DESCRIPTION
Start Port	Enter the original destination port for the packets. To forward only one port, enter the port number again in the External End Port field. To forward a series of ports, enter the start port number here and the end port number in the External End Port field.
End Port	Enter the last port of the original destination port range. To forward only one port, enter the port number in the External Start Port field above and then enter it again in this field. To forward a series of ports, enter the last port number in a series that begins with the port number in the External Start Port field above.
Translation Start Port	This shows the port number to which you want the ZyXEL Device to translate the incoming port. For a range of ports, enter the first number of the range to which you want the incoming ports translated.
Translation End Port	This shows the last port of the translated port range.
Server IP Address	Enter the inside IP address of the virtual server here.
Protocol Type	Select the protocol supported by this virtual server. Choices are TCP , UDP , or TCP/UDP .
Apply	Click Apply to save your changes.
Back	Click Back to return to the previous screen without saving.

11.3 The Sessions Screen

Use the **Sessions** screen to limit the number of concurrent NAT sessions each client can use.

Click **Network Setting > NAT > Sessions** to display the following screen.

Figure 79 Network Setting > NAT > Sessions

MAX NAT Session Per Host : (100 - 20480)

Note :
Enter session number and click 'Apply' to activate this feature.
Clear the session number field and click 'Apply' to deactivate this feature.

The following table describes the fields in this screen.

Table 47 Network Setting > NAT > Sessions

LABEL	DESCRIPTION
MAX NAT Session	Use this field to set a common limit to the number of concurrent NAT sessions each client computer can have. If only a few clients use peer to peer applications, you can raise this number to improve their performance. With heavy peer to peer application use, lower this number to ensure no single client uses too many of the available NAT sessions.
Apply	Click Apply to save your changes.
Cancel	Click Cancel to restore your previously saved settings.

11.4 Technical Reference

This section provides some technical background information about the topics covered in this chapter.

11.4.1 NAT Definitions

Inside/outside denotes where a host is located relative to the ZyXEL Device, for example, the computers of your subscribers are the inside hosts, while the web servers on the Internet are the outside hosts.

Global/local denotes the IP address of a host in a packet as the packet traverses a router, for example, the local address refers to the IP address of a host when the packet is in the local network, while the global address refers to the IP address of the host when the same packet is traveling in the WAN side.

Note that inside/outside refers to the location of a host, while global/local refers to the IP address of a host used in a packet. Thus, an inside local address (ILA) is the IP address of an inside host in a packet when the packet is still in the local network, while an inside global address (IGA) is the IP address of the same inside host when the packet is on the WAN side. The following table summarizes this information.

Table 48 NAT Definitions

ITEM	DESCRIPTION
Inside	This refers to the host on the LAN.
Outside	This refers to the host on the WAN.
Local	This refers to the packet address (source or destination) as the packet travels on the LAN.
Global	This refers to the packet address (source or destination) as the packet travels on the WAN.

NAT never changes the IP address (either local or global) of an outside host.

11.4.2 What NAT Does

In the simplest form, NAT changes the source IP address in a packet received from a subscriber (the inside local address) to another (the inside global address) before forwarding the packet to the WAN side. When the response comes back, NAT translates the destination address (the inside global address) back to the inside local address before forwarding it to the original inside host. Note that the IP address (either local or global) of an outside host is never changed.

The global IP addresses for the inside hosts can be either static or dynamically assigned by the ISP. In addition, you can designate servers, for example, a web server and a Telnet server, on your local network and make them accessible to the outside world. If you do not define any servers, NAT offers the additional benefit of firewall protection. With no servers defined, your ZyXEL Device filters out all incoming inquiries, thus preventing intruders from probing your network. For more information on IP address translation, refer to *RFC 1631, The IP Network Address Translator (NAT)*.

11.4.3 How NAT Works

Each packet has two addresses – a source address and a destination address. For outgoing packets, the ILA (Inside Local Address) is the source address on the LAN, and the IGA (Inside Global Address) is the source address on the WAN. For incoming packets, the ILA is the destination address on the LAN, and the IGA is the destination address on the WAN. NAT maps private (local) IP addresses to globally unique ones required for communication with hosts on other networks. It replaces the original IP source address (and TCP or UDP source port numbers for Many-to-One and Many-to-Many Overload NAT mapping) in each packet and then forwards it to the Internet. The ZyXEL Device keeps track of the original addresses

and port numbers so incoming reply packets can have their original values restored. The following figure illustrates this.

Figure 80 How NAT Works

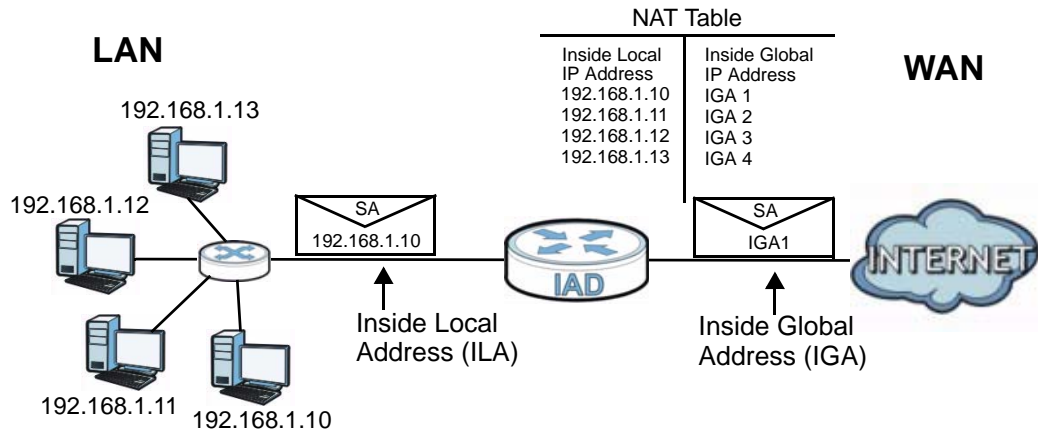

Dynamic DNS

12.1 Overview

This chapter discusses how to configure your ZyXEL Device to use Dynamic DNS.

Dynamic DNS allows you to update your current dynamic IP address with one or many dynamic DNS services so that anyone can contact you (in applications such as NetMeeting and CU-SeeMe). You can also access your FTP server or Web site on your own computer using a domain name (for instance myhost.dhs.org, where myhost is a name of your choice) that will never change instead of using an IP address that changes each time you reconnect. Your friends or relatives will always be able to call you even if they don't know your IP address.

First of all, you need to have registered a dynamic DNS account with www.dyndns.org. This is for people with a dynamic IP from their ISP or DHCP server that would still like to have a domain name. The Dynamic DNS service provider will give you a password or key.

12.1.1 What You Need To Know

DYNDNS Wildcard

Enabling the wildcard feature for your host causes *.yourhost.dyndns.org to be aliased to the same IP address as yourhost.dyndns.org. This feature is useful if you want to be able to use, for example, www.yourhost.dyndns.org and still reach your hostname.

If you have a private WAN IP address, then you cannot use Dynamic DNS.

12.2 The Dynamic DNS Screen

Use the **Dynamic DNS** screen to enable DDNS and configure the DDNS settings on the ZyXEL Device. To change your ZyXEL Device's DDNS, click **Network Setting > DNS**. The screen appears as shown.

Figure 81 Network Setting > DNS

The following table describes the fields in this screen.

Table 49 Network Setting > DNS

LABEL	DESCRIPTION
Dynamic DNS Configuration	
Active Dynamic DNS	Select this check box to use dynamic DNS.
Service Provider	Select the name of your Dynamic DNS service provider.
Dynamic DNS Type	Select the type of service that you are registered for from your Dynamic DNS service provider.
Host Name	Type the domain name assigned to your ZyXEL Device by your Dynamic DNS provider. You can specify up to two host names in the field separated by a comma (",").
User Name	Type your user name.
Password	Type the password assigned to you.
Apply	Click Apply to save your changes.
Cancel	Click Cancel to restore your previously saved settings.

13.1 Overview

Use the ZyXEL Device firewall screens to enable and configure the firewall that protects your ZyXEL Device and network from attacks by hackers on the Internet and control access to it. By default the firewall:

- allows traffic that originates from your LAN and WLAN computers to go to all other networks.
- blocks traffic that originates on other networks from going to the LAN and WLAN.

The following figure illustrates the default firewall action. User **A** can initiate an IM (Instant Messaging) session from the LAN to the WAN (1). Return traffic for this session is also allowed (2). However other traffic initiated from the WAN is blocked (3 and 4).

Figure 82 Default Firewall Action

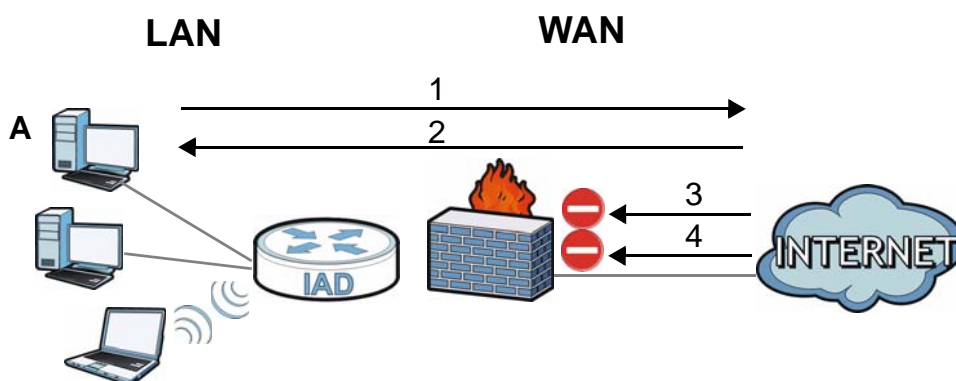

13.1.1 What You Can Do in this Chapter

- Use the **General** screen to enable or disable the ZyXEL Device's firewall ([Section 13.2 on page 215](#)).
- Use the **Services** screen to view the configured firewall rules and add, edit or remove a firewall rule ([Section 13.3 on page 215](#)).

13.1.2 What You Need to Know

Firewall

The ZyXEL Device's firewall feature physically separates the LAN/WLAN and the WAN and acts as a secure gateway for all data passing between the networks.

It is designed to protect against Denial of Service (DoS) attacks when activated. The ZyXEL Device's purpose is to allow a private Local Area Network (LAN) to be securely connected to the Internet. The ZyXEL Device can be used to prevent theft, destruction and modification of data, as well as log events, which may be important to the security of your network.

The ZyXEL Device is installed between the LAN/WLAN and a broadband modem connecting to the Internet. This allows it to act as a secure gateway for all data passing between the Internet and the LAN.

The ZyXEL Device has one Ethernet WAN port and four Ethernet LAN ports, which are used to physically separate the network into two areas. The WAN (Wide Area Network) port attaches to the broadband (cable or DSL) modem to the Internet.

The LAN (Local Area Network) port attaches to a network of computers, which needs security from the outside world. These computers will have access to Internet services such as e-mail, FTP and the World Wide Web. However, "inbound access" is not allowed (by default) unless the remote host is authorized to use a specific service.

ICMP

Internet Control Message Protocol (ICMP) is a message control and error-reporting protocol between a host server and a gateway to the Internet. ICMP uses Internet Protocol (IP) datagrams, but the messages are processed by the TCP/IP software and directly apparent to the application user.

Finding Out More

See [Section 13.4 on page 217](#) for advanced technical information on firewall.

13.2 The General Screen

Use this screen to enable or disable the ZyXEL Device's firewall. Click **Security > Firewall** to open the **General** screen.

Figure 83 Security > Firewall > General

The screenshot shows a web interface for the Firewall General settings. On the left, the word "Firewall" is displayed. To its right, there are two radio buttons: "Enable" (which is selected) and "Disable". At the bottom right of the screen, there are two buttons: "Apply" and "Cancel".

The following table describes the labels in this screen.

Table 50 Security > Firewall > General

LABEL	DESCRIPTION
Firewall	Select Enable to activate the firewall. The ZyXEL Device performs access control and protects against Denial of Service (DoS) attacks when the firewall is activated.
Apply	Click Apply to save your changes.
Cancel	Click Cancel to restore your previously saved settings.

13.3 The Services Screen

Use this screen to enable service blocking and to maintain the list of services you want to block. To access this screen, click **Security > Firewall > Services**.

Note: These rules specify which computers on the LAN can access which computers or services on the WAN.

Figure 84 Security > Firewall > Services

Each field is described in the following table.

Table 51 Security > Firewall > Services

LABEL	DESCRIPTION
LAN-to-WAN Services Blocking	Select Enable to activate service blocking.
Available Services	This is a list of pre-defined services (destination ports) you may prohibit your LAN computers from using. Select the port you want to block, and click Add to add the port to the Blocked Services field. A custom port is a service that is not available in the pre-defined Available Services list. You must define it using the Type and Port Number fields. See Appendix E on page 387 for some examples of services.
Blocked Services	This is a list of services (ports) that are inaccessible to computers on your LAN when service blocking is effective. To remove a service from this list, select the service, and click Delete .
Type	Select TCP , UDP or TCP and UDP , based on which one the custom port uses.
Port Number	Enter the range of port numbers that defines the service. For example, suppose you want to define the Gnutella service. Select TCP type and enter a port range of 6345-6349 .
Add	Click this to add the selected service in Available Services to the Blocked Services list. Note that the service is blocked immediately after clicking this.

Table 51 Security > Firewall > Services (continued)

LABEL	DESCRIPTION
Delete	Select a service in the Blocked Services , and click this to remove the service from the list.
Clear All	Click this to remove all the services in the Blocked Services list.
Apply	Click Apply to save your changes.
Cancel	Click Cancel to restore your previously saved settings.

13.4 Firewall Technical Reference

This section provides some technical background information about the topics covered in this chapter.

13.4.1 Guidelines For Enhancing Security With Your Firewall

- 1 Change the default password via web configurator.
- 2 Think about access control before you connect to the network in any way.
- 3 Limit who can access your ZyXEL Device.
- 4 Don't enable any local service (such as Telnet or FTP) that you don't use. Any enabled service could present a potential security risk. A determined hacker might be able to find creative ways to misuse the enabled services to access the firewall or the network.
- 5 For local services that are enabled, protect against misuse. Protect by configuring the services to communicate only with specific peers, and protect by configuring rules to block packets for the services at specific interfaces.
- 6 Keep the firewall in a secured (locked) room.

13.4.2 Security Considerations

Note: Incorrectly configuring the firewall may block valid access or introduce security risks to the ZyXEL Device and your protected network. Use caution when creating or deleting firewall rules and test your rules after you configure them.

Consider these security ramifications before creating a rule:

- 1 Does this rule stop LAN users from accessing critical resources on the Internet? For example, if IRC is blocked, are there users that require this service?

- 2 Is it possible to modify the rule to be more specific? For example, if IRC is blocked for all users, will a rule that blocks just certain users be more effective?
- 3 Does a rule that allows Internet users access to resources on the LAN create a security vulnerability? For example, if FTP ports (TCP 20, 21) are allowed from the Internet to the LAN, Internet users may be able to connect to computers with running FTP servers.
- 4 Does this rule conflict with any existing rules?

Once these questions have been answered, adding rules is simply a matter of entering the information into the correct fields in the web configurator screens.

MAC Filter

14.1 Overview

This chapter discusses MAC address filtering.

You can configure the ZyXEL Device to permit access to clients based on their MAC addresses in the **MAC Filter** screen. This applies to wired and wireless connections.

14.1.1 What You Need to Know

Every Ethernet device has a unique MAC (Media Access Control) address. The MAC address is assigned at the factory and consists of six pairs of hexadecimal characters, for example, 00:A0:C5:00:00:02. You need to know the MAC address of the devices to configure this screen.

14.2 The MAC Filter Screen

Use the **MAC Filter** screen to allow wireless clients access to the ZyXEL Device. To change your ZyXEL Device's MAC filter settings, click **Security > MAC Filter**. The screen appears as shown.

Figure 85 Security > MAC Filter

MAC Address Filter: Enable Disable

Set	Allow	MAC Address
1	<input type="checkbox"/>	00:24:21:7E:20:96
2	<input type="checkbox"/>	
3	<input type="checkbox"/>	
4	<input type="checkbox"/>	
5	<input type="checkbox"/>	
6	<input type="checkbox"/>	
7	<input type="checkbox"/>	
8	<input type="checkbox"/>	
9	<input type="checkbox"/>	
10	<input type="checkbox"/>	
11	<input type="checkbox"/>	
12	<input type="checkbox"/>	
27	<input type="checkbox"/>	
28	<input type="checkbox"/>	
29	<input type="checkbox"/>	
30	<input type="checkbox"/>	
31	<input type="checkbox"/>	
32	<input type="checkbox"/>	

Note:
Only devices listed here are granted access to the network.

Apply Cancel

The following table describes the labels in this menu.

Table 52 Security > MAC Filter

LABEL	DESCRIPTION
MAC Address Filter	Select Enable to activate MAC address filtering.
Set	This is the index number of the MAC address.
Allow	Select Allow to permit access to the ZyXEL Device. MAC addresses not listed will be denied access to the ZyXEL Device. If you clear this, the MAC Address field for this set clears.
MAC Address	Enter the MAC addresses of the wireless station that are allowed access to the ZyXEL Device in these address fields. Enter the MAC addresses in a valid MAC address format, that is, six hexadecimal character pairs, for example, 12:34:56:78:9a:bc.
Apply	Click Apply to save your changes.
Cancel	Click Cancel to restore your previously saved settings.

Certificates

15.1 Overview

The ZyXEL Device can use certificates (also called digital IDs) to authenticate users. Certificates are based on public-private key pairs. A certificate contains the certificate owner's identity and public key. Certificates provide a way to exchange public keys for use in authentication.

15.1.1 What You Can Do in this Chapter

- Use the **Local Certificate** screens to view and import the ZyXEL Device's CA-signed certificates ([Section 15.2 on page 224](#)).
- Use the **Trusted CA** screens to save the certificates of trusted CAs to the ZyXEL Device. You can also export the certificates to a computer ([Section 15.3 on page 226](#)).

15.1.2 What You Need to Know

The following terms and concepts may help as you read this chapter.

Certification Authorities

A Certification Authority (CA) issues certificates and guarantees the identity of each certificate owner. There are commercial certification authorities like CyberTrust or VeriSign and government certification authorities.

Public and Private Keys

When using public-key cryptology for authentication, each host has two keys. One key is public and can be made openly available; the other key is private and must be kept secure. Public-key encryption in general works as follows.

- 1 Tim wants to send a private message to Jenny. Tim generates a public-private key pair. What is encrypted with one key can only be decrypted using the other.
- 2 Tim keeps the private key and makes the public key openly available.

- 3 Tim uses his private key to encrypt the message and sends it to Jenny.
- 4 Jenny receives the message and uses Tim's public key to decrypt it.
- 5 Additionally, Jenny uses her own private key to encrypt a message and Tim uses Jenny's public key to decrypt the message.

The ZyXEL Device uses certificates based on public-key cryptology to authenticate users attempting to establish a connection. The method used to secure the data that you send through an established connection depends on the type of connection. For example, a VPN tunnel might use the triple DES encryption algorithm.

The certification authority uses its private key to sign certificates. Anyone can then use the certification authority's public key to verify the certificates.

Certification Path

A certification path is the hierarchy of certification authority certificates that validate a certificate. The ZyXEL Device does not trust a certificate if any certificate on its path has expired or been revoked.

Certificate Directory Servers

Certification authorities maintain directory servers with databases of valid and revoked certificates. A directory of certificates that have been revoked before the scheduled expiration is called a CRL (Certificate Revocation List). The ZyXEL Device can check a peer's certificate against a directory server's list of revoked certificates. The framework of servers, software, procedures and policies that handles keys is called PKI (public-key infrastructure).

Advantages of Certificates

Certificates offer the following benefits.

- The ZyXEL Device only has to store the certificates of the certification authorities that you decide to trust, no matter how many devices you need to authenticate.
- Key distribution is simple and very secure since you can freely distribute public keys and you never need to transmit private keys.

Certificate File Formats

The certification authority certificate that you want to import has to be in one of these file formats:

- Binary X.509: This is an ITU-T recommendation that defines the formats for X.509 certificates.
- PEM (Base-64) encoded X.509: This Privacy Enhanced Mail format uses 64 ASCII characters to convert a binary X.509 certificate into a printable form.
- Binary PKCS#7: This is a standard that defines the general syntax for data (including digital signatures) that may be encrypted. The ZyXEL Device currently allows the importation of a PKCS#7 file that contains a single certificate.
- PEM (Base-64) encoded PKCS#7: This Privacy Enhanced Mail (PEM) format uses 64 ASCII characters to convert a binary PKCS#7 certificate into a printable form.

Note: Be careful not to convert a binary file to text during the transfer process. It is easy for this to occur since many programs use text files by default.

15.1.3 Verifying a Certificate

Before you import a trusted CA or trusted remote host certificate into the ZyXEL Device, you should verify that you have the actual certificate. This is especially true of trusted CA certificates since the ZyXEL Device also trusts any valid certificate signed by any of the imported trusted CA certificates.

You can use a certificate's fingerprint to verify it. A certificate's fingerprint is a message digest calculated using the MD5 or SHA1 algorithms. The following procedure describes how to check a certificate's fingerprint to verify that you have the actual certificate.

- 1 Browse to where you have the certificate saved on your computer.
- 2 Make sure that the certificate has a ".cer" or ".crt" file name extension.

Figure 86 Certificates on Your Computer

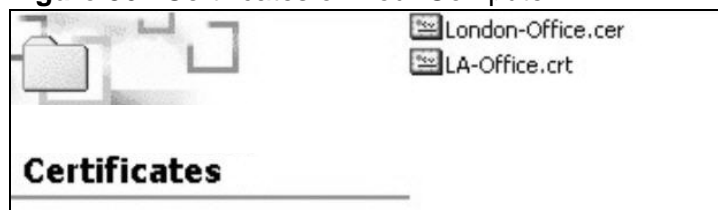

- 3 Double-click the certificate's icon to open the **Certificate** window. Click the **Details** tab and scroll down to the **Thumbprint Algorithm** and **Thumbprint** fields.

Figure 87 Certificate Details

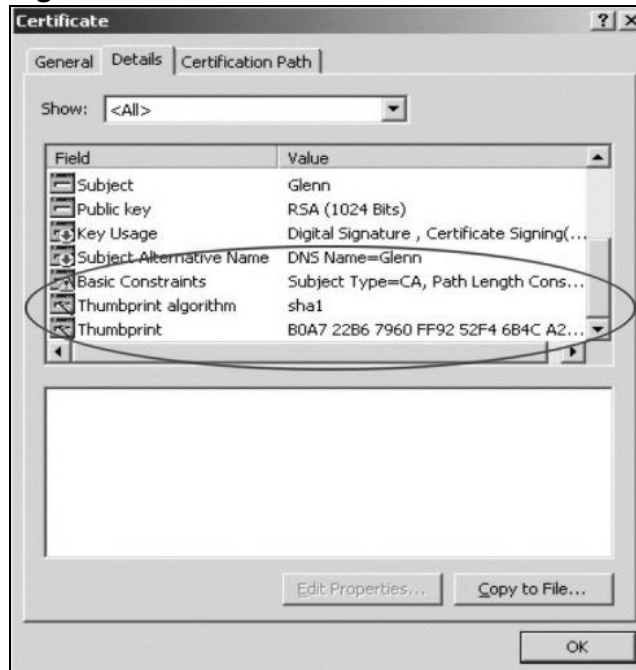

- 4 Use a secure method to verify that the certificate owner has the same information in the **Thumbprint Algorithm** and **Thumbprint** fields. The secure method may vary based on your situation. Possible examples would be over the telephone or through an HTTPS connection.

15.2 Local Certificates

Use this screen to view the ZyXEL Device's summary list of certificates and certification requests. You can import the following certificates to your ZyXEL Device:

- Web Server - This certificate secures HTTP connections.
- SIP TLS - This certificate secures VoIP connections.
- SSH/SCP/SFTP - This certificate secures remote connections.

Click **Security > Certificates** to open the **Local Certificates** screen.

Figure 88 Security > Certificates > Local Certificates

Replace PrivateKey/Certificate file in PEM format

WebServer

Current File	Subject	Issuer	Valid From	Valid To	Cert
web.pem	O=ZyXEL, CN=zyxel.com.tw	O=ZyXEL, CN=zyxel.com.tw	2009-10-07 00:48:07 GMT	2019-10-05 00:48:07 GMT	

SSH/SCP/SFTP

Current File	Key Type
ssh.rsa	RSA

Note :
SSH/SCP/SFTP -- Maximum key length supported is up to 4096 bits (default is 2048 bits), and the initialization time is proportional to key length. You need to adjust your application timeout settings to adapt this variation.

The following table describes the labels in this screen.

Table 53 Security > Certificates > Local Certificates

LABEL	DESCRIPTION
Web Server	Type in the location of the Web Server certificate file you want to upload in this field or click Browse to find it.
Browse	Click Browse to find the certificate file you want to upload.
Current File	This field displays the name used to identify this certificate. It is recommended that you give each certificate a unique name.
Subject	This field displays identifying information about the certificate's owner, such as CN (Common Name), OU (Organizational Unit or department), O (Organization or company) and C (Country). It is recommended that each certificate have unique subject information.
Issuer	This field displays identifying information about the certificate's issuing certification authority, such as a common name, organizational unit or department, organization or company and country.
Valid From	This field displays the date that the certificate becomes applicable. The text displays in red and includes a Not Yet Valid! message if the certificate has not yet become applicable.
Valid To	This field displays the date that the certificate expires. The text displays in red and includes an Expiring! or Expired! message if the certificate is about to expire or has already expired.
Cert	Click this button and then Save in the File Download screen. The Save As screen opens, browse to the location that you want to use and click Save .
SSH/SCP/SFTP	Type in the location of the SSH/SCP/SFTP certificate file you want to upload in this field or click Browse to find it.
Browse	Click Browse to find the certificate file you want to upload.
Current File	This field displays the name used to identify this certificate. It is recommended that you give each certificate a unique name.

Table 53 Security > Certificates > Local Certificates (continued)

LABEL	DESCRIPTION
Key Type	This field applies to the SSH/SCP/SFTP certificate. This shows the file format of the current certificate.
Replace	Click this to replace the certificate(s) and save your changes back to the ZyXEL Device.
Reset	Click this to clear your settings.

15.3 Trusted CA

Use this screen to view a summary list of certificates of the certification authorities that you have set the ZyXEL Device to accept as trusted. The ZyXEL Device accepts any valid certificate signed by a certification authority on this list as being trustworthy; thus you do not need to import any certificate that is signed by one of these certification authorities.

Click **Security > Certificates > Trusted CA** to open the **Trusted CA** screen.

Figure 89 Security > Certificates > Trusted CA

The screenshot shows the 'Trusted CA' screen. At the top left is a button labeled 'Import Certificate'. Below it is a table with the following data:

Name	Subject	Type	Action
certnew.cer	DC=com, DC=ZyXEL, CN=ZyXELCA	CA	[Edit] [Delete]

Below the table is a 'Note' section with the text: 'Maximum 5 certificates can be stored.'

The following table describes the labels in this screen.

Table 54 Security > Certificates > Trusted CA

LABEL	DESCRIPTION
Import Certificate	Click this button to open a screen where you can save the certificate of a certification authority that you trust to the ZyXEL Device.
Name	This field displays the name used to identify this certificate.
Subject	This field displays information that identifies the owner of the certificate, such as Common Name (CN), OU (Organizational Unit or department), Organization (O), State (ST) and Country (C). It is recommended that each certificate have unique subject information.

Table 54 Security > Certificates > Trusted CA (continued)

LABEL	DESCRIPTION
Type	This field displays general information about the certificate. ca means that a Certification Authority signed the certificate.
Action	Click the View icon to open a screen with an in-depth list of information about the certificate (or certification request). Click the Delete icon to delete the certificate (or certification request). You cannot delete a certificate that one or more features is configured to use.

15.4 Trusted CA Import

Click **Import Certificate** in the **Trusted CA** screen to open the **Import Certificate** screen. You can save a trusted certification authority's certificate to the ZyXEL Device.

Note: You must remove any spaces from the certificate's filename before you can import the certificate.

Figure 90 Trusted CA > Import

The certificate is in one of the following formats.

- Binary X.509
- PEM (Base-64) encoded
- Binary PKCS#7
- PEM (Base-64) encoded PKCS#7

Certificate File Path:

The following table describes the labels in this screen.

Table 55 Security > Certificates > Trusted CA > Import

LABEL	DESCRIPTION
Certificate File Path	Type in the location of the file you want to upload in this field or click Browse to find it.
Browse	Click Browse to find the certificate file you want to upload.
Apply	Click Apply to save the certificate on the ZyXEL Device.
Back	Click Back to return to the previous screen.

15.5 View Certificate

Use this screen to view in-depth information about the certification authority's certificate, change the certificate's name and set whether or not you want the ZyXEL Device to check a certification authority's list of revoked certificates before trusting a certificate issued by the certification authority.

Click **Security** > **Certificates** > **Trusted CA** to open the **Trusted CA** screen. Click the **View** icon to open the **View Certificate** screen.

Figure 91 Trusted CA: View



The following table describes the labels in this screen.

Table 56 Trusted CA: View

LABEL	DESCRIPTION
Certificate Name	This field displays the identifying name of this certificate. If you want to change the name, type up to 31 characters to identify this key certificate. You may use any character (not including spaces).
Certificate Detail	This read-only text box displays the certificate or certification request in Privacy Enhanced Mail (PEM) format. PEM uses 64 ASCII characters to convert the binary certificate into a printable form. You can copy and paste the certificate into an e-mail to send to friends or colleagues or you can copy and paste the certificate into a text editor and save the file on a management computer for later distribution (via floppy disk for example).
Back	Click this to return to the previous screen.

16.1 Overview

Use this chapter to:

- Connect an analog phone to the ZyXEL Device.
- Make phone calls over the Internet, as well as the regular phone network.
- Configure settings such as speed dial.
- Configure network settings to optimize the voice quality of your phone calls.

16.1.1 What You Can Do in this Chapter

These screens allow you to configure your ZyXEL Device to make phone calls over the Internet and your regular phone line, and to set up the phones you connect to the ZyXEL Device.

- Use the **SIP Service Provider** screen to configure the SIP server information, QoS for VoIP calls, the numbers for certain phone functions ([Section 16.3 on page 235](#)).
- Use the **SIP Account** screen to set up information about your SIP account, control which SIP accounts the phones connected to the ZyXEL Device use and configure audio settings such as volume levels for the phones connected to the ZyXEL Device ([Section 16.3 on page 235](#)).
- Use the **Common** screen to configure RFC3262 support on the ZyXEL Device ([Section 16.5 on page 242](#)).
- Use the **Phone Device** screen to control which SIP accounts the phones connected to the ZyXEL Device use ([Section 16.6 on page 243](#)).
- Use the **Region** screen to change settings that depend on the country you are in ([Section 16.7 on page 245](#)).
- Use the **Call Rule** screen to set up shortcuts for dialing frequently-used (VoIP) phone numbers ([Section 16.8 on page 245](#)).

You don't necessarily need to use all these screens to set up your account. In fact, if your service provider did not supply information on a particular field in a screen, it is usually best to leave it at its default setting.

16.1.2 What You Need to Know

The following terms and concepts may help as you read this chapter.

VoIP

VoIP stands for Voice over IP. IP is the Internet Protocol, which is the message-carrying standard the Internet runs on. So, Voice over IP is the sending of voice signals (speech) over the Internet (or another network that uses the Internet Protocol).

SIP

SIP stands for Session Initiation Protocol. SIP is a signalling standard that lets one network device (like a computer or the ZyXEL Device) send messages to another. In VoIP, these messages are about phone calls over the network. For example, when you dial a number on your ZyXEL Device, it sends a SIP message over the network asking the other device (the number you dialed) to take part in the call.

SIP Accounts

A SIP account is a type of VoIP account. It is an arrangement with a service provider that lets you make phone calls over the Internet. When you set the ZyXEL Device to use your SIP account to make calls, the ZyXEL Device is able to send all the information about the phone call to your service provider on the Internet.

Strictly speaking, you don't need a SIP account. It is possible for one SIP device (like the ZyXEL Device) to call another without involving a SIP service provider. However, the networking difficulties involved in doing this make it tremendously impractical under normal circumstances. Your SIP account provider removes these difficulties by taking care of the call routing and setup - figuring out how to get your call to the right place in a way that you and the other person can talk to one another.

Voice Activity Detection/Silence Suppression

Voice Activity Detection (VAD) detects whether or not speech is present. This lets the ZyXEL Device reduce the bandwidth that a call uses by not transmitting "silent packets" when you are not speaking.

Comfort Noise Generation

When using VAD, the ZyXEL Device generates comfort noise when the other party is not speaking. The comfort noise lets you know that the line is still connected as total silence could easily be mistaken for a lost connection.

Echo Cancellation

G.168 is an ITU-T standard for eliminating the echo caused by the sound of your voice reverberating in the telephone receiver while you talk.

Use this screen to maintain basic information about each SIP account. You can also enable and disable each SIP account, configure the volume, echo cancellation and VAD (Voice Activity Detection) settings for each individual phone port on the ZyXEL Device.

How to Find Out More

See [Chapter 3 on page 37](#) for a tutorial showing how to set up these screens in an example scenario.

See [Section 16.9 on page 247](#) for advanced technical information on SIP.

16.1.3 Before You Begin

- Before you can use these screens, you need to have a VoIP account already set up. If you don't have one yet, you can sign up with a VoIP service provider over the Internet.
- You should have the information your VoIP service provider gave you ready, before you start to configure the ZyXEL Device.

16.2 The SIP Service Provider Screen

Use this screen to configure the SIP server information, QoS for VoIP calls, the numbers for certain phone functions and dialing plan. Click **VoIP > SIP** to open the **SIP Service Provider** screen.

Note: Click **more...** to see all the fields in the screen. You don't necessarily need to use all these fields to set up your account. Click **hide more** to see and configure only the fields needed for this feature.

Figure 92 VoIP > SIP > SIP Service Provider

SIP Service Provider Selection

Service Provider Selection :

General

SIP Service Provider : Enable SIP Service Provider

SIP Service Provider Name :

SIP Local Port : (1025-65535)

SIP Server Address :

SIP Server Port : (1025-65535)

REGISTER Server Address :

REGISTER Server Port : (1025-65535)

SIP Service Domain :

[hide more](#)

RTP Port Range

Start Port : (1025-65535)

End Port : (1025-65535)

DTMF Mode

DTMF Mode :

Transport Type

Transport Type :

FAX Option

G711 Fax Passthrough T38 Fax Relay

Outbound Proxy

Enable

Server Address :

Server Port : (1025-65535)

QoS Tag

SIP TOS Priority Setting : (0-255)

RTP TOS Priority Setting : (0-255)

Timer Setting

Expiration Duration : (20-65535) second

Register Re-send timer : (180-65535) second

Session Expires : (100-3600) second

Min-SE : (90-1800) second

Dialing Interval Selection

Dialing Interval Selection : second

Bound Interface Name

Bound Interface Name :

The following table describes the labels in this screen.

Table 57 VoIP > SIP > SIP Service Provider

LABEL	DESCRIPTION
SIP Service Provider Selection	
Service Provider Selection	Select the SIP service provider profile you want to use for the SIP account you configure in this screen. If you change this field, the screen automatically refreshes. If you want to configure a new service provider, select Add New .
General	
SIP Service Provider	Select this if you want the ZyXEL Device to use this SIP provider. Clear it if you do not want the ZyXEL Device to use this SIP provider.
SIP Service Provider Name	Enter the name of your SIP service provider.
SIP Local Port	Enter the ZyXEL Device's listening port number, if your VoIP service provider gave you one. Otherwise, keep the default value.
SIP Server Address	Enter the IP address or domain name of the SIP server provided by your VoIP service provider. You can use up to 95 printable ASCII characters. It does not matter whether the SIP server is a proxy, redirect or register server.
SIP Server Port	Enter the SIP server's listening port number, if your VoIP service provider gave you one. Otherwise, keep the default value.
REGISTER Server Address	Enter the IP address or domain name of the SIP register server, if your VoIP service provider gave you one. Otherwise, enter the same address you entered in the SIP Server Address field. You can use up to 95 printable ASCII characters.
REGISTER Server Port	Enter the SIP register server's listening port number, if your VoIP service provider gave you one. Otherwise, enter the same port number you entered in the SIP Server Port field.
SIP Service Domain	Enter the SIP service domain name. In the full SIP URI, this is the part after the @ symbol. You can use up to 127 printable ASCII Extended set characters.
RTP Port Range	
Start Port End Port	<p>Enter the listening port number(s) for RTP traffic, if your VoIP service provider gave you this information. Otherwise, keep the default values.</p> <p>To enter one port number, enter the port number in the Start Port and End Port fields.</p> <p>To enter a range of ports,</p> <ul style="list-style-type: none"> • enter the port number at the beginning of the range in the Start Port field. • enter the port number at the end of the range in the End Port field.

Table 57 VoIP > SIP > SIP Service Provider (continued)

LABEL	DESCRIPTION
DTMF Mode	<p>Control how the ZyXEL Device handles the tones that your telephone makes when you push its buttons. You should use the same mode your VoIP service provider uses.</p> <p>RFC2833 - send the DTMF tones in RTP packets.</p> <p>PCM - send the DTMF tones in the voice data stream. This method works best when you are using a codec that does not use compression (like G.711). Codecs that use compression (like G.729 and G.726) can distort the tones.</p> <p>SIP INFO - send the DTMF tones in SIP messages.</p>
Transport Type	
Transport Type	Select the transport layer protocol (TCP , UDP or TCP) used for SIP.
FAX Option	This field controls how the ZyXEL Device handles fax messages.
G711 Fax Passthrough	Select this if the ZyXEL Device should use G.711 to send fax messages. The peer devices must also use G.711.
T38 Fax Relay	Select this if the ZyXEL Device should send fax messages as UDP or TCP/IP packets through IP networks. This provides better quality, but it may have inter-operability problems. The peer devices must also use T.38.
Outbound Proxy	
Enable	Select this if your VoIP service provider has a SIP outbound server to handle voice calls. This allows the ZyXEL Device to work with any type of NAT router and eliminates the need for STUN or a SIP ALG. Turn off any SIP ALG on a NAT router in front of the ZyXEL Device to keep it from re-translating the IP address (since this is already handled by the outbound proxy server).
Server Address	Enter the IP address or domain name of the SIP outbound proxy server.
Server Port	Enter the SIP outbound proxy server's listening port, if your VoIP service provider gave you one. Otherwise, keep the default value.
QoS Tag	
SIP TOS Priority Setting	Enter the DSCP (DiffServ Code Point) number for SIP message transmissions. The ZyXEL Device creates Class of Service (CoS) priority tags with this number to SIP traffic that it transmits.
RTP TOS Priority Setting	Enter the DSCP (DiffServ Code Point) number for RTP voice transmissions. The ZyXEL Device creates Class of Service (CoS) priority tags with this number to RTP traffic that it transmits.
Timer Setting	
Expiration Duration	Enter the number of seconds your SIP account is registered with the SIP register server before it is deleted. The ZyXEL Device automatically tries to re-register your SIP account when one-half of this time has passed. (The SIP register server might have a different expiration.)
Register Re-send timer	Enter the number of seconds the ZyXEL Device waits before it tries again to register the SIP account, if the first try failed or if there is no response.
Session Expires	Enter the number of seconds the ZyXEL Device lets a SIP session remain idle (without traffic) before it automatically disconnects the session.

Table 57 VoIP > SIP > SIP Service Provider (continued)

LABEL	DESCRIPTION
Min-SE	Enter the minimum number of seconds the ZyXEL Device lets a SIP session remain idle (without traffic) before it automatically disconnects the session. When two SIP devices start a SIP session, they must agree on an expiration time for idle sessions. This field is the shortest expiration time that the ZyXEL Device accepts.
Dialing Interval Selection	
Dialing Interval Selection	Enter the number of seconds the ZyXEL Device should wait after you stop dialing numbers before it makes the phone call. The value depends on how quickly you dial phone numbers.
Bound Interface Name	
Bound Interface Name	If you select LAN or AnyWAN , the ZyXEL Device automatically activates the VoIP service when any LAN or WAN connection is up. If you select MultiWAN , you also need to select the pre-configured WAN connections. The VoIP service is activated only when the selected WAN connection is up.
Apply	Click Apply to save your changes.
Cancel	Click Cancel to restore your previously saved settings.

16.3 The SIP Account Screen

The ZyXEL Device uses a SIP account to make outgoing VoIP calls and check if an incoming call's destination number matches your SIP account's SIP number. In order to make or receive a VoIP call, you need to enable and configure a SIP account, and map it to a phone port. The SIP account contains information that allows your ZyXEL Device to connect to your VoIP service provider.

See [Section 16.6 on page 243](#) for how to map a SIP account to a phone port.

To access the following screen, click **VoIP > SIP > SIP Account**.

Figure 93 VoIP > SIP > SIP Account

Add new SIP account					
#	Active	SIP Account	SIP Service Provider	Account No.	Modify
1		SIP 1	ChangeMe	ChangeMe	
2		SIP 2	ChangeMe	ChangeMe	

The following table describes the labels in this screen.

Table 58 VoIP > SIP > SIP Account

LABEL	DESCRIPTION
Add new SIP Account	Click this to configure a new SIP account.
#	This is the index number of the entry.
Active	This shows whether the SIP account is activated or not. A yellow bulb signifies that this SIP account is activated. A gray bulb signifies that this SIP account is activated.
SIP Account	This shows the name of the SIP account.
Account No.	This shows the SIP number.
Modify	Click the Edit icon to configure the SIP account. Click the Delete icon to delete this SIP account from the ZyXEL Device.

16.3.1 Add/Edit SIP Account

You can configure a new SIP account or edit one. To access this screen, click **Add new SIP Account** in the **SIP Account** screen or the **Edit** icon next to an existing account.

Figure 94 SIP Account: Add/Edit

SIP Service Provider Selection	
Service Provider Selection :	<input type="text" value="ChangeMe"/>
General	
SIP Account :	<input type="checkbox"/> Active SIP Account
SIP Account Number :	<input type="text" value="ChangeMe"/>
Authenticaton	
Username :	<input type="text" value="ChangeMe"/>
Password :	<input type="text"/>
URL Type	
URL Type :	<input type="text" value="SIP"/>
Voice Features	
Primary Compression Type :	<input type="text" value="G.711MuLaw"/>
Second Compression Type :	<input type="text" value="G.711ALaw"/>
Third Compression Type :	<input type="text" value="G.729"/>
Speaking Volume Control :	<input type="text" value="Middle"/>
Listening Volume Control :	<input type="text" value="Middle"/>
<input checked="" type="checkbox"/> Active G.168(Echo Cancellation)	
<input checked="" type="checkbox"/> Active VAD(Voice Active Detector)	
Call Features	
<input checked="" type="checkbox"/> Send Caller ID	
<input checked="" type="checkbox"/> Active Call Transfer	
<input checked="" type="checkbox"/> Active Call Waiting :	
Active Call Waiting Reject Time :	<input type="text" value="24"/> (10-60) second
<input type="checkbox"/> Active Unconditional Forward	To Number : <input type="text"/>
<input type="checkbox"/> Active Busy Forward	To Number : <input type="text"/>
<input type="checkbox"/> Active No Answer Forward	To Number : <input type="text"/>
No Answer Ring Time	<input type="text" value="5"/> (10~180) Second
<input type="button" value="Apply"/> <input type="button" value="Back"/>	

Each field is described in the following table.

Table 59 SIP Account: Add/Edit

LABEL	DESCRIPTION
SIP Service Provider Selection	
Service Provider Selection	Select the SIP service provider profile you want to use for the SIP account you configure in this screen. This field is view-only if you are editing the SIP account.
General	
SIP Account	Select the Active SIP Account check box if you want the ZyXEL Device to use this account. Clear it if you do not want the ZyXEL Device to use this account.
SIP Account Number	Enter your SIP number. In the full SIP URI, this is the part before the @ symbol. You can use up to 127 printable ASCII characters.
Authentication	
Username	Enter the user name for registering this SIP account, exactly as it was given to you. You can use up to 95 printable ASCII characters.
Password	Enter the password for registering this SIP account, exactly as it was given to you. You can use up to 95 printable ASCII characters.
URL Type	
URL Type	Select whether or not to include the SIP service domain name when the ZyXEL Device sends the SIP number. SIP - include the SIP service domain name. TEL - do not include the SIP service domain name.
Voice Features	
Primary Compression Type	Select the type of voice coder/decoder (codec) that you want the ZyXEL Device to use. G.711 provides higher voice quality but requires more bandwidth (64 kbps).
Secondary Compression Type	<ul style="list-style-type: none"> • G.711MuLaw is typically used in North America and Japan. • G.711ALaw is typically used in Europe. • G.729 only requires 8 kbps. • G.726-32 operates at 16, 24, 32 or 40 kbps. • G.722 operates at 48, 56 and 64 kbps. The ZyXEL Device must use the same codec as the peer. When two SIP devices start a SIP session, they must agree on a codec.
Third Compression Type	Select the ZyXEL Device's first choice for voice coder/decoder. Select the ZyXEL Device's second choice for voice coder/decoder. Select None if you only want the ZyXEL Device to accept the first choice. Select the ZyXEL Device's third choice for voice coder/decoder. Select None if you only want the ZyXEL Device to accept the first or second choice.
Speaking Volume Control	Enter the loudness that the ZyXEL Device uses for speech that it sends to the peer device. Minimum is the quietest, and Maximum is the loudest.

Table 59 SIP Account: Add/Edit (continued)

LABEL	DESCRIPTION
Listening Volume Control	Enter the loudness that the ZyXEL Device uses for speech that it receives from the peer device. Minimum is the quietest, and Maximum is the loudest.
Active G.168 (Echo Cancellation)	Select this if you want to eliminate the echo caused by the sound of your voice reverberating in the telephone receiver while you talk.
Active VAD (Voice Active Detector)	Select this if the ZyXEL Device should stop transmitting when you are not speaking. This reduces the bandwidth the ZyXEL Device uses.
Call Features	
Send Caller ID	Select this if you want to send identification when you make VoIP phone calls. Clear this if you do not want to send identification.
Active Call Transfer	Select this to enable call transfer on the ZyXEL Device. This allows you to transfer an incoming call (that you have answered) to another phone.
Active Call Waiting	Select this to enable call waiting on the ZyXEL Device. This allows you to place a call on hold while you answer another incoming call on the same telephone (directory) number.
Active Call Waiting Reject Time	Specify a time of seconds that the ZyXEL Device waits before rejecting the second call if you do not answer it.
Active Unconditional Forward	Select this if you want the ZyXEL Device to forward all incoming calls to the specified phone number. Specify the phone number in the To Number field on the right.
Active Busy Forward	Select this if you want the ZyXEL Device to forward incoming calls to the specified phone number if the phone port is busy. Specify the phone number in the To Number field on the right. If you have call waiting, the incoming call is forwarded to the specified phone number if you reject or ignore the second incoming call.
Active No Answer Forward	Select this if you want the ZyXEL Device to forward incoming calls to the specified phone number if the call is unanswered. (See No Answer Time .) Specify the phone number in the To Number field on the right.
No Answer Ring Time	This field is used by the Active No Answer Forward feature. Enter the number of seconds the ZyXEL Device should wait for you to answer an incoming call before it considers the call is unanswered.
Apply	Click Apply to save your changes.
Back	Click Back to return to the previous screen without saving.

16.4 Multiple SIP Accounts

You can set up two SIP accounts on your ZyXEL Device and your ZyXEL Device is equipped with two phone ports. By default your ZyXEL Device uses SIP account 1 with both phone ports for outgoing calls, and it uses SIP accounts 1 and 2 for incoming calls. With this setting, you always use SIP account 1 for your outgoing calls and you cannot distinguish which SIP account the calls are coming in through. If you want to control the use of different dialing plans for accounting purposes or other reasons, you need to configure your phone ports in order to control which SIP account you are using when placing or receiving calls.

16.4.1 Outgoing Calls

The following figure represents the default behavior of your ZyXEL Device when two SIP accounts are configured and you are using two phones. When you place a call from phone port 1 or phone port 2, the ZyXEL Device will use SIP account 1.

Figure 95 Outgoing Calls: Default

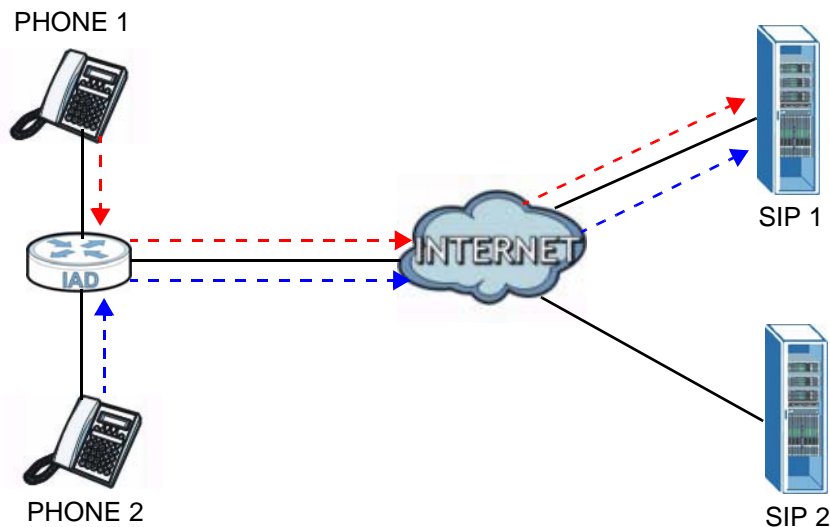

In the next example, phone port 1 is configured to use SIP account 1 and phone port 2 is configured to use SIP account 2. In this case, every time you place a call through phone port 1, you are using your SIP account 1. Similarly, every time you place a call through phone port 2, you are using your SIP account 2. To apply

these configuration changes you need to configure the **Phone Device** screen. See [Section 16.6 on page 243](#).

Figure 96 Outgoing Calls: Individual Configuration

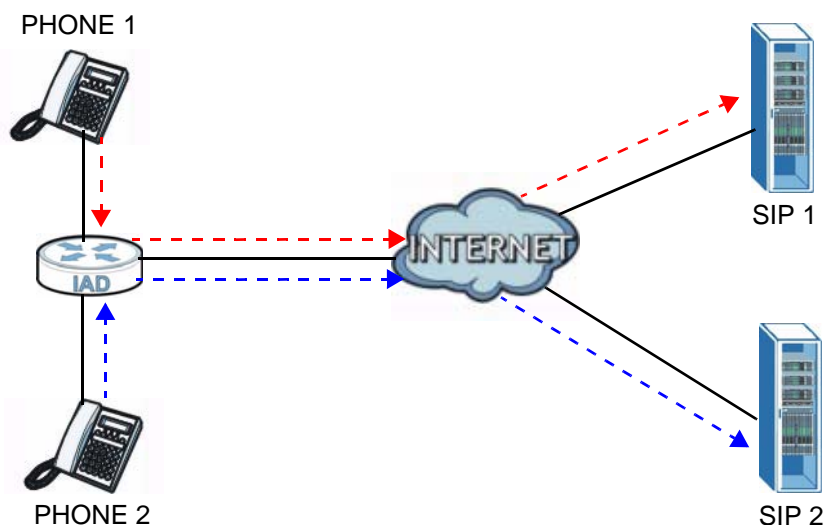

16.4.2 Incoming Calls

The following example shows the default behavior of your ZyXEL Device for incoming calls when two SIP accounts are configured and you are using two phones. When a call comes in from your SIP account 1, the phones connected to both phone port 1 and phone port 2 ring. Similarly, when a call comes in from your SIP account 2, the phones connected to both phone port 1 and phone port 2 ring. In either case you are not sure which SIP account the call is coming from.

Figure 97 Incoming Calls: Default

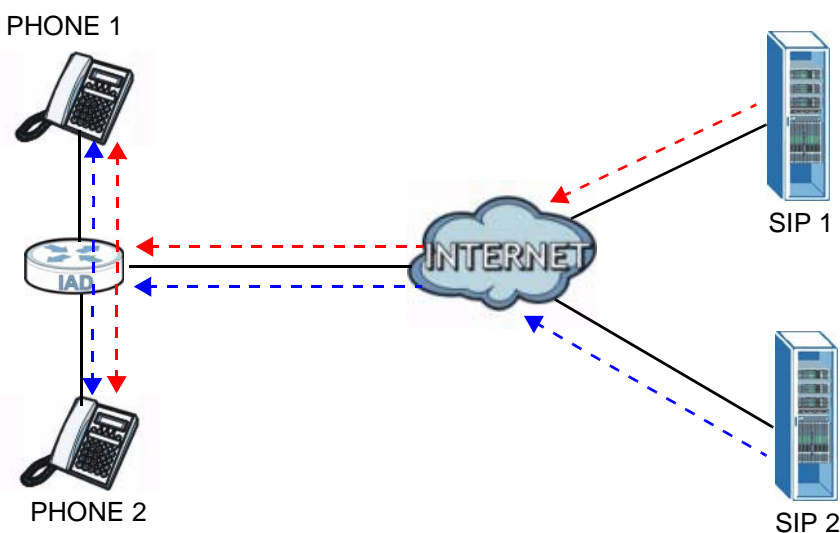

In the next example, phone port 1 is configured to use SIP account 1 and phone port 2 is configured to use SIP account 2 for incoming calls. In this case, every time you receive a call from your SIP account 1, the phone connected to phone port 1 rings. Similarly, every time you receive a call from your SIP account 2, phone port 2 rings. To apply these configuration changes you need to configure the **Phone Device** screen. See [Section 16.6 on page 243](#).

Figure 98 Incoming Calls: Individual Configuration

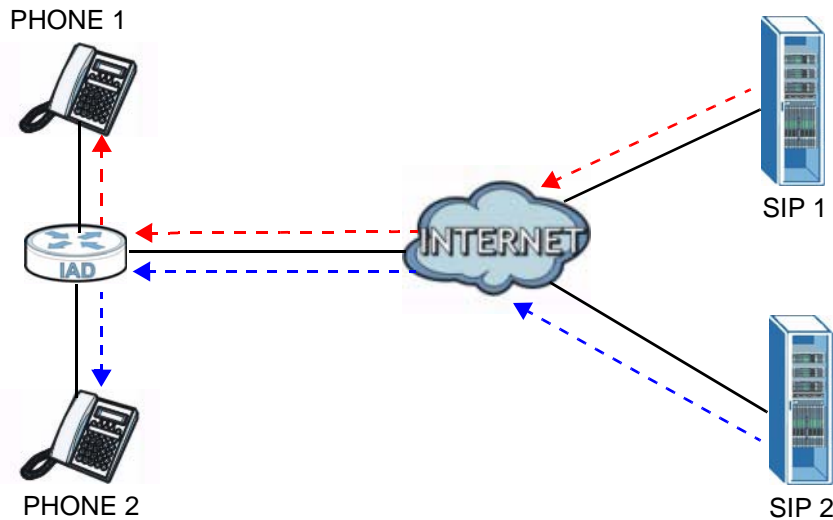

16.5 The Common Screen

Use the **Common** screen to configure RFC3262 support on the ZyXEL Device. To access the following screen, click **VoIP > SIP > Common**.

Figure 99 VoIP > SIP > Common

RFC Support	
PRACK (RFC 3262):	<input type="text" value="Supported"/>
<input type="button" value="Apply"/> <input type="button" value="Cancel"/>	

Each field is described in the following table.



Table 60 VoIP > SIP > Common

LABEL	DESCRIPTION
RFC Support	
PRACK (RFC 3262)	<p>RFC 3262 defines a mechanism to provide reliable transmission of SIP provisional response messages, which convey information on the processing progress of the request. This uses the option tag 100rel and the Provisional Response ACKnowledgement (PRACK) method.</p> <p>Select Supported or Required to have the ZyXEL Device include a SIP Require/Supported header field with the option tag 100rel in all INVITE requests. When the ZyXEL Device receives a SIP response message indicating that the phone it called is ringing, the ZyXEL Device sends a PRACK message to have both sides confirm the message is received.</p> <p>If you select Supported, the peer device supports the option tag 100rel to send provisional responses reliably.</p> <p>If you select Required, the peer device requires the option tag 100rel to send provisional responses reliably.</p>
Apply	Click Apply to save your changes.
Cancel	Click Cancel to return to the previous screen without saving.

16.6 The Phone Device Screen

Use this screen to control which SIP accounts and PSTN line each phone uses. Click **VoIP > Phone** to access the **Phone Device** screen.

Figure 100 VoIP > Phone > Phone Device

Analog Phone			
#	Phone ID	Outgoing SIP Number	Modify
1	Analog Phone 1	ChangeMe	
2	Analog Phone 2	ChangeMe	

The following table describes the labels in this screen.

Table 61 VoIP > Phone > Phone Device

LABEL	DESCRIPTION
#	This is the index number of the entry.
Phone ID	This is the phone device number.
Outgoing SIP Number	This is the outgoing SIP number of the phone device.
Modify	Click the Edit icon to configure the SIP account.

16.6.1 Edit Phone Device

You can edit an SIP account by clicking the **Edit** icon next to an SIP account entry. You cannot edit the account if it is not activated. Go to **VoIP > SIP > SIP Account > Edit** to activate an SIP account (see [Section 16.3.1 on page 237](#) for more information).

Figure 101 Phone Device: Edit

SIP Account to Make Outgoing Call			
SIP Account	SIP Number	SIP Account	SIP Number
<input checked="" type="radio"/> SIP 1	ChangeMe	<input type="radio"/> SIP 2	ChangeMe

SIP Account(s) to Receive Incoming Call			
SIP Account	SIP Number	SIP Account	SIP Number
<input checked="" type="checkbox"/> SIP 1	ChangeMe	<input type="checkbox"/> SIP 2	ChangeMe

The following table describes the labels in this screen.

Table 62 Phone Device: Edit

LABEL	DESCRIPTION
SIP Account to Make Outgoing Call	
SIP Account	Select the SIP account you want to use when making outgoing calls with the analog phone connected to this phone port.
SIP Number	This shows the SIP account number.
SIP Account(s) to Receive Incoming Call	
SIP Account	Select a SIP account if you want to receive phone calls for the selected SIP account on this phone port. If you select more than one SIP account for incoming calls, there is no way to distinguish between them when you receive phone calls. If you do not select a source for incoming calls, you cannot receive any calls on this phone port.
SIP Number	This shows the SIP account number.
Apply	Click Apply to save your changes.
Back	Click Back to return to the previous screen without saving.

16.7 The Region Screen

Use this screen to maintain settings that depend on which region of the world the ZyXEL Device is in. To access this screen, click **VoIP > Phone > Region**.

Figure 102 VoIP > Phone > Region

Region Settings :

Note :
Caution: When Region Settings is changed, you need to reboot device to take settings effect.

Apply

Each field is described in the following table.

Table 63 VoIP > Phone > Region

LABEL	DESCRIPTION
Region Settings	Select the place in which the ZyXEL Device is located.
Apply	Click Apply to save your changes.

16.8 The Call Rule Screen

Use this screen to add, edit, or remove speed-dial numbers for outgoing calls. Speed dial provides shortcuts for dialing frequently-used (VoIP) phone numbers. You also have to create speed-dial entries if you want to call SIP numbers that contain letters. Once you have configured a speed dial rule, you can use a shortcut (the speed dial number, #01 for example) on your phone's keypad to call the phone number.

To access this screen, click **VoIP > Phone > Call Rule**.

Figure 103 VoIP > Phone > Call Rule

The screenshot shows a web interface for configuring speed dial entries. It is divided into two main sections: 'Speed Dial' and 'Phone Book'.

Speed Dial Section:

- Header: #, Number, Description, SIPNumber
- Form fields: A dropdown menu with '1' selected, an empty text box for 'Number', an empty text box for 'Description', and an 'Add' button.

Phone Book Section:

- Header: #, Number, Description, Modify
- Table with 10 rows, each representing a speed-dial entry from #01 to #10. Each row has a 'Modify' column with edit and delete icons.

At the bottom right of the interface are 'Clear' and 'Cancel' buttons.

Each field is described in the following table.

Table 64 VoIP > Phone > Call Rule

LABEL	DESCRIPTION
Speed Dial	Use this section to create or edit speed-dial entries.
#	Select the speed-dial number you want to use for this phone number.
Number	Enter the SIP number you want the ZyXEL Device to call when you dial the speed-dial number.
Description	Enter a short description to identify the party you call when you dial the speed-dial number. You can use up to 127 printable ASCII characters.
Add	Click this to use the information in the Speed Dial section to update the Speed Dial Phone Book section.
Phone Book	Use this section to look at all the speed-dial entries and to erase them.
#	This field displays the speed-dial number you should dial to use this entry.
Number	This field displays the SIP number the ZyXEL Device calls when you dial the speed-dial number.
Description	This field displays a short description of the party you call when you dial the speed-dial number.
Modify	Use this field to edit or erase the speed-dial entry. Click the Edit icon to copy the information for this speed-dial entry into the Speed Dial section, where you can change it. Click Add when you finish editing to change the configurations. Click the Delete icon to erase this speed-dial entry.

Table 64 VoIP > Phone > Call Rule (continued)

LABEL	DESCRIPTION
Clear	Click this to erase all the speed-dial entries.
Cancel	Click this to set every field in this screen to its last-saved value.

16.9 Technical Reference

This section contains background material relevant to the **VoIP** screens.

16.9.1 VoIP

VoIP is the sending of voice signals over Internet Protocol. This allows you to make phone calls and send faxes over the Internet at a fraction of the cost of using the traditional circuit-switched telephone network. You can also use servers to run telephone service applications like PBX services and voice mail. Internet Telephony Service Provider (ITSP) companies provide VoIP service.

Circuit-switched telephone networks require 64 kilobits per second (Kbps) in each direction to handle a telephone call. VoIP can use advanced voice coding techniques with compression to reduce the required bandwidth.

16.9.2 SIP

The Session Initiation Protocol (SIP) is an application-layer control (signaling) protocol that handles the setting up, altering and tearing down of voice and multimedia sessions over the Internet.

SIP signaling is separate from the media for which it handles sessions. The media that is exchanged during the session can use a different path from that of the signaling. SIP handles telephone calls and can interface with traditional circuit-switched telephone networks.

SIP Identities

A SIP account uses an identity (sometimes referred to as a SIP address). A complete SIP identity is called a SIP URI (Uniform Resource Identifier). A SIP account's URI identifies the SIP account in a way similar to the way an e-mail address identifies an e-mail account. The format of a SIP identity is SIP-Number@SIP-Service-Domain.

SIP Number

The SIP number is the part of the SIP URI that comes before the "@" symbol. A SIP number can use letters like in an e-mail address (johndoe@your-ITSP.com for example) or numbers like a telephone number (1122334455@VoIP-provider.com for example).

SIP Service Domain

The SIP service domain of the VoIP service provider is the domain name in a SIP URI. For example, if the SIP address is 1122334455@VoIP-provider.com, then "VoIP-provider.com" is the SIP service domain.

SIP Registration

Each ZyXEL Device is an individual SIP User Agent (UA). To provide voice service, it has a public IP address for SIP and RTP protocols to communicate with other servers.

A SIP user agent has to register with the SIP registrar and must provide information about the users it represents, as well as its current IP address (for the routing of incoming SIP requests). After successful registration, the SIP server knows that the users (identified by their dedicated SIP URIs) are represented by the UA, and knows the IP address to which the SIP requests and responses should be sent.

Registration is initiated by the User Agent Client (UAC) running in the VoIP gateway (the ZyXEL Device). The gateway must be configured with information letting it know where to send the REGISTER message, as well as the relevant user and authorization data.

A SIP registration has a limited lifespan. The User Agent Client must renew its registration within this lifespan. If it does not do so, the registration data will be deleted from the SIP registrar's database and the connection broken.

The ZyXEL Device attempts to register all enabled subscriber ports when it is switched on. When you enable a subscriber port that was previously disabled, the ZyXEL Device attempts to register the port immediately.

Authorization Requirements

SIP registrations (and subsequent SIP requests) require a username and password for authorization. These credentials are validated via a challenge / response system using the HTTP digest mechanism (as detailed in RFC3261, "SIP: Session Initiation Protocol").

SIP Servers

SIP is a client-server protocol. A SIP client is an application program or device that sends SIP requests. A SIP server responds to the SIP requests.

When you use SIP to make a VoIP call, it originates at a client and terminates at a server. A SIP client could be a computer or a SIP phone. One device can act as both a SIP client and a SIP server.

SIP User Agent

A SIP user agent can make and receive VoIP telephone calls. This means that SIP can be used for peer-to-peer communications even though it is a client-server protocol. In the following figure, either **A** or **B** can act as a SIP user agent client to initiate a call. **A** and **B** can also both act as a SIP user agent to receive the call.

Figure 104 SIP User Agent

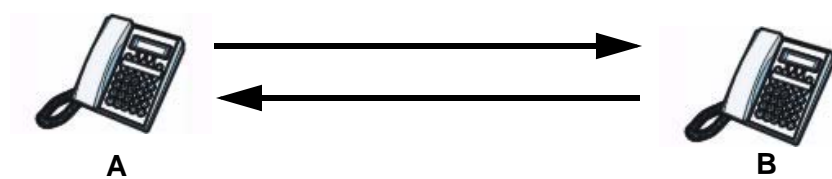

SIP Proxy Server

A SIP proxy server receives requests from clients and forwards them to another server.

In the following example, you want to use client device **A** to call someone who is using client device **C**.

- 1 The client device (**A** in the figure) sends a call invitation to the SIP proxy server **B**.

- 2 The SIP proxy server forwards the call invitation to **C**.

Figure 105 SIP Proxy Server

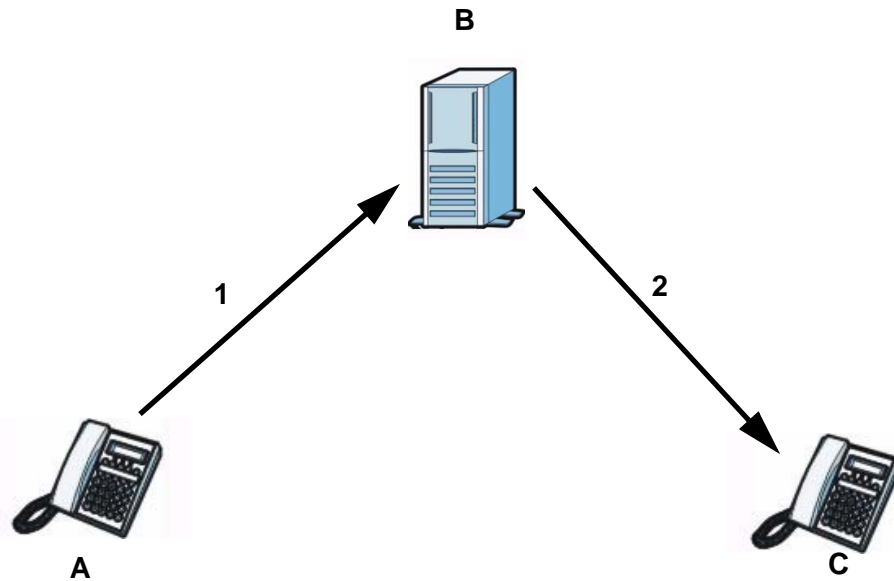

SIP Redirect Server

A SIP redirect server accepts SIP requests, translates the destination address to an IP address and sends the translated IP address back to the device that sent the request. Then the client device that originally sent the request can send requests to the IP address that it received back from the redirect server. Redirect servers do not initiate SIP requests.

In the following example, you want to use client device **A** to call someone who is using client device **C**.

- 1 Client device **A** sends a call invitation for **C** to the SIP redirect server **B**.
- 2 The SIP redirect server sends the invitation back to **A** with **C**'s IP address (or domain name).

- 3 Client device **A** then sends the call invitation to client device **C**.

Figure 106 SIP Redirect Server

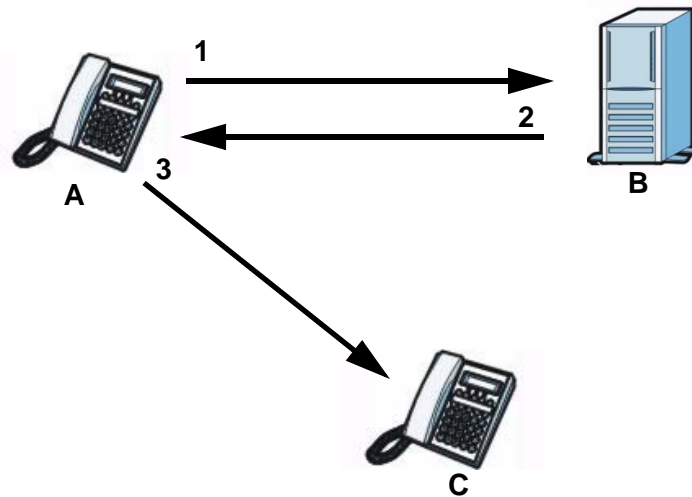

SIP Register Server

A SIP register server maintains a database of SIP identity-to-IP address (or domain name) mapping. The register server checks your user name and password when you register.

RTP

When you make a VoIP call using SIP, the RTP (Real time Transport Protocol) is used to handle voice data transfer. See RFC 3550 for details on RTP.

Pulse Code Modulation

Pulse Code Modulation (PCM) measures analog signal amplitudes at regular time intervals and converts them into bits.

SIP Call Progression

The following figure displays the basic steps in the setup and tear down of a SIP call. A calls B.

Table 65 SIP Call Progression

A		B
1. INVITE	→	
	←	2. Ringing
	←	3. OK
4. ACK	→	

Table 65 SIP Call Progression (continued)

A		B
	5. Dialogue (voice traffic)	
6. BYE	→	
	←	7. OK

- 1 **A** sends a SIP INVITE request to **B**. This message is an invitation for **B** to participate in a SIP telephone call.
- 2 **B** sends a response indicating that the telephone is ringing.
- 3 **B** sends an OK response after the call is answered.
- 4 **A** then sends an ACK message to acknowledge that **B** has answered the call.
- 5 Now **A** and **B** exchange voice media (talk).
- 6 After talking, **A** hangs up and sends a BYE request.
- 7 **B** replies with an OK response confirming receipt of the BYE request and the call is terminated.

Voice Coding

A codec (coder/decoder) codes analog voice signals into digital signals and decodes the digital signals back into analog voice signals. The ZyXEL Device supports the following codecs.

- G.711 is a Pulse Code Modulation (PCM) waveform codec. PCM measures analog signal amplitudes at regular time intervals and converts them into digital samples. G.711 provides very good sound quality but requires 64 kbps of bandwidth.
- G.726 is an Adaptive Differential PCM (ADPCM) waveform codec that uses a lower bitrate than standard PCM conversion. ADPCM converts analog audio into digital signals based on the difference between each audio sample and a prediction based on previous samples. The more similar the audio sample is to the prediction, the less space needed to describe it. G.726 operates at 16, 24, 32 or 40 kbps.
- G.729 is an Analysis-by-Synthesis (AbS) hybrid waveform codec that uses a filter based on information about how the human vocal tract produces sounds. G.729 provides good sound quality and reduces the required bandwidth to 8 kbps.

PSTN Call Setup Signaling

Dual-Tone MultiFrequency (DTMF) signaling uses pairs of frequencies (one lower frequency and one higher frequency) to set up calls. It is also known as Touch Tone®. Each of the keys on a DTMF telephone corresponds to a different pair of frequencies.

Pulse dialing sends a series of clicks to the local phone office in order to dial numbers.³

MWI (Message Waiting Indication)

Enable Message Waiting Indication (MWI) enables your phone to give you a message–waiting (beeping) dial tone when you have a voice message(s). Your VoIP service provider must have a messaging system that sends message waiting status SIP packets as defined in RFC 3842.

16.9.3 Quality of Service (QoS)

Quality of Service (QoS) refers to both a network's ability to deliver data with minimum delay, and the networking methods used to provide bandwidth for real-time multimedia applications.

Type of Service (ToS)

Network traffic can be classified by setting the ToS (Type of Service) values at the data source (for example, at the ZyXEL Device) so a server can decide the best method of delivery, that is the least cost, fastest route and so on.

DiffServ

DiffServ is a class of service (CoS) model that marks packets so that they receive specific per-hop treatment at DiffServ-compliant network devices along the route based on the application types and traffic flow. Packets are marked with DiffServ Code Points (DSCP) indicating the level of service desired. This allows the intermediary DiffServ-compliant network devices to handle the packets differently depending on the code points without the need to negotiate paths or remember state information for every flow. In addition, applications do not have to request a particular service or give advanced notice of where the traffic is going.⁴

3. The ZyXEL Device does not support pulse dialing at the time of writing.

4. The ZyXEL Device does not support DiffServ at the time of writing.

DSCP and Per-Hop Behavior

DiffServ defines a new DS (Differentiated Services) field to replace the Type of Service (TOS) field in the IP header. The DS field contains a 2-bit unused field and a 6-bit DSCP field which can define up to 64 service levels. The following figure illustrates the DS field.

DSCP is backward compatible with the three precedence bits in the ToS octet so that non-DiffServ compliant, ToS-enabled network device will not conflict with the DSCP mapping.

Figure 107 DiffServ: Differentiated Service Field

DSCP (6-bit)	Unused (2-bit)
-----------------	-------------------

The DSCP value determines the forwarding behavior, the PHB (Per-Hop Behavior), that each packet gets across the DiffServ network. Based on the marking rule, different kinds of traffic can be marked for different priorities of forwarding. Resources can then be allocated according to the DSCP values and the configured policies.

VLAN Tagging

Virtual Local Area Network (VLAN) allows a physical network to be partitioned into multiple logical networks. Only stations within the same group can communicate with each other.

Your ZyXEL Device can add IEEE 802.1Q VLAN ID tags to voice frames that it sends to the network. This allows the ZyXEL Device to communicate with a SIP server that is a member of the same VLAN group. Some ISPs use the VLAN tag to identify voice traffic and give it priority over other traffic.

16.9.4 Phone Services Overview

Supplementary services such as call hold, call waiting, and call transfer, are generally available from your VoIP service provider. The ZyXEL Device supports the following services:

- Call Hold
- Call Waiting
- Making a Second Call
- Call Transfer
- Three-Way Conference

- Internal Calls
- Do not Disturb

Note: To take full advantage of the supplementary phone services available through the ZyXEL Device's phone ports, you may need to subscribe to the services from your VoIP service provider.

The Flash Key

Flashing means to press the hook for a short period of time (a few hundred milliseconds) before releasing it. On newer telephones, there should be a "flash" key (button) that generates the signal electronically. If the flash key is not available, you can tap (press and immediately release) the hook by hand to achieve the same effect. However, using the flash key is preferred since the timing is much more precise. With manual tapping, if the duration is too long, it may be interpreted as hanging up by the ZyXEL Device.

You can invoke all the supplementary services by using the flash key.

Europe Type Supplementary Phone Services

This section describes how to use supplementary phone services with the **Europe Type Call Service Mode**. Commands for supplementary services are listed in the table below.

After pressing the flash key, if you do not issue the sub-command before the default sub-command time-out (2 seconds) expires or issue an invalid sub-command, the current operation will be aborted.

Table 66 European Flash Key Commands

COMMAND	SUB-COMMAND	DESCRIPTION
Flash		Put a current call on hold to place a second call. Switch back to the call (if there is no second call).
Flash	0	Drop the call presently on hold or reject an incoming call which is waiting for answer.
Flash	1	Disconnect the current phone connection and answer the incoming call or resume with caller presently on hold.
Flash	2	1. Switch back and forth between two calls. 2. Put a current call on hold to answer an incoming call. 3. Separate the current three-way conference call into two individual calls (one is on-line, the other is on hold).
Flash	3	Create three-way conference connection.
Flash	*98#	Transfer the call to another phone.

European Call Hold

Call hold allows you to put a call (**A**) on hold by pressing the flash key.

If you have another call, press the flash key and then "2" to switch back and forth between caller **A** and **B** by putting either one on hold.

Press the flash key and then "0" to disconnect the call presently on hold and keep the current call on line.

Press the flash key and then "1" to disconnect the current call and resume the call on hold.

If you hang up the phone but a caller is still on hold, there will be a remind ring.

European Call Waiting

This allows you to place a call on hold while you answer another incoming call on the same telephone (directory) number.

If there is a second call to a telephone number, you will hear a call waiting tone. Take one of the following actions.

- Reject the second call.
Press the flash key and then press "0".
- Disconnect the first call and answer the second call.
Either press the flash key and press "1", or just hang up the phone and then answer the phone after it rings.
- Put the first call on hold and answer the second call.
Press the flash key and then "2".

European Call Transfer

Do the following to transfer a call (that you have answered) to another phone number.

- 1 Press the flash key to put the caller on hold.
- 2 When you hear the dial tone, dial "*98#" followed by the number to which you want to transfer the call. to operate the Intercom.
- 3 After you hear the ring signal or the second party answers it, hang up the phone.

European Three-Way Conference

Use the following steps to make three-way conference calls.

- 1 When you are on the phone talking to someone, press the flash key to put the call on hold and get a dial tone.
- 2 Dial a phone number directly to make another call.
- 3 When the second call is answered, press the flash key and press "3" to create a three-way conversation.
- 4 Hang up the phone to drop the connection.
- 5 If you want to separate the activated three-way conference into two individual connections (one is on-line, the other is on hold), press the flash key and press "2".

17.1 Overview

The web configurator allows you to choose which categories of events and/or alerts to have the ZyXEL Device log and then display the logs or have the ZyXEL Device send them to an administrator (as e-mail) or to a syslog server.

Note: The ZyXEL Device's log feature is only for Voice over IP (VoIP).

17.1.1 What You Can Do in this Chapter

- Use the **Phone Log** screen to view phone logs and alert messages ([Section 17.2 on page 259](#)).
- Use The **VoIP Call History** screen to view the details of the calls performed on the ZyXEL Device ([Section 17.3 on page 260](#)).

17.2 The Phone Log Screen

Click **System Monitor > Log** to open the **Phone Log** screen. Use this screen to view phone logs and alert messages. You can select the type of log and level of severity to display.

Figure 108 System Monitor > Log > Phone Log

#	Time	Level	Message
1	Aug 20 07:37:17	err	SIP Registration: SIP:12875: Register Fail, error_cause 43
2	Aug 20 07:37:40	info	[ChangeMe] [FXS2] Phone Event: OFFHOOK
3	Aug 20 07:37:43	info	[ChangeMe] [FXS2] Phone Event: ONHOOK
4	Aug 20 07:37:43	info	[ChangeMe] [FXS2] Phone Event: idle
5	Aug 20 07:39:05	info	[ChangeMe] [FXS2] Phone Event: OFFHOOK
6	Aug 20 07:39:28	info	[ChangeMe] [FXS2] Phone Event: ONHOOK
7	Aug 20 07:39:28	info	[ChangeMe] [FXS2] Phone Event: idle
8	Aug 20 07:41:14	info	SIP Registration: SIP:128752: Register Success
9	Aug 20 07:41:49	info	[ChangeMe] [FXS2] Phone Event: OFFHOOK
10	Aug 20 07:41:56	info	[ChangeMe] [FXS2] Phone Event: ONHOOK

The following table describes the fields in this screen.

Table 67 System Monitor > Log > Phone Log

LABEL	DESCRIPTION
	Select a category of logs to view from the drop-down list box. select All Logs to view all logs.
Level	Select the severity level that you want to view.
Refresh	Click this to renew the log screen.
Clear Logs	Click this to delete all the logs.
#	This field is a sequential value and is not associated with a specific entry.
Time	This field displays the time the log was recorded.
Level	This field displays the severity level of the logs that the device is to send to this syslog server.
Message	This field states the reason for the log.

17.3 The VoIP Call History Screen

Click **System Monitor > Log > Call History** to open the **VoIP Call History** screen. Use this screen to see the details of the calls performed on the ZyXEL Device.

Figure 109 System Monitor > Log > Call History

#	Time	Local Number	Peer Number	Interface	Duration
1	08/20/2010 09:43:52	128752	1353699	SIP	0:00:00
2	08/20/2010 09:43:07	128752	1353699	SIP	0:00:06
3	08/20/2010 09:42:11	128752	1353699	SIP	0:00:37

The following table describes the fields in this screen.

Table 68 System Monitor > Log > Call History

LABEL	DESCRIPTION
	Select a category of call records to view from the drop-down list box. select All Call History to view all call records.
Refresh	Click this to renew the log screen.
Clear Logs	Click this to delete all the logs.
#	This field is a sequential value and is not associated with a specific entry.
Time	This field displays the time the call was recorded.
Local Number	This field displays the phone number you used to make or receive this call.
Peer Number	This field displays the phone number you called or from which this call is made.

Table 68 System Monitor > Log > Call History

LABEL	DESCRIPTION
Interface	This field displays the type of the call.
Duration	This field displays how long the call lasted.

System Monitor

18.1 Overview

Use the **System Monitor** screens to look at network traffic status and statistics of the WAN, LAN interfaces, NAT, and 3G backup.

18.1.1 What You Can Do in this Chapter

- Use the **WAN** screen to view the WAN traffic statistics ([Section 18.2 on page 264](#)).
- Use the **LAN** screen to view the LAN traffic statistics ([Section 18.3 on page 265](#)).
- Use the **NAT** screen to view the NAT status of the ZyXEL Device's client(s) ([Section 18.4 on page 266](#)).
- Use the **3G Backup** screen to view the 3G connection traffic statistics ([Section 18.5 on page 266](#)).
- Use the **VoIP Status** screen to view the VoIP traffic statistics ([Section 18.6 on page 267](#)).

18.2 The WAN Status Screen

Click **System Monitor > Traffic Status** to open the **WAN** screen. You can view the WAN traffic statistics in this screen.

Figure 110 System Monitor > Traffic Status > WAN

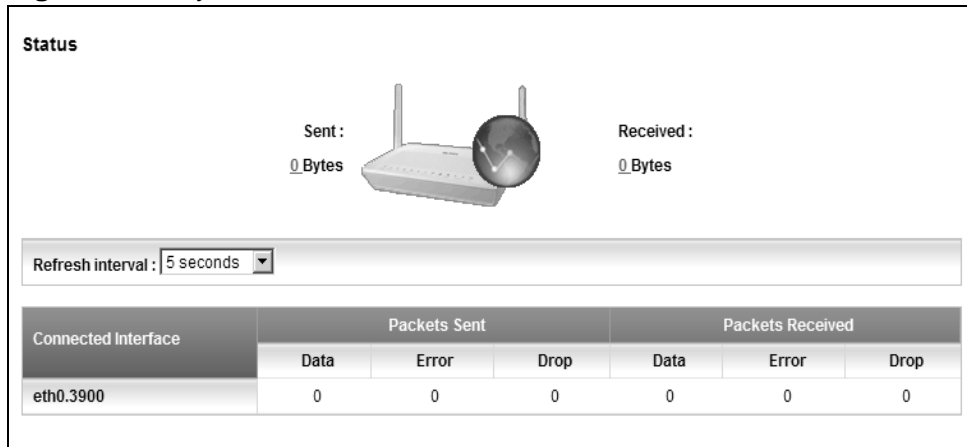

The following table describes the fields in this screen.

Table 69 System Monitor > Traffic Status > WAN

LABEL	DESCRIPTION
Status	This shows the number of bytes received and sent through the WAN interface of the ZyXEL Device.
Refresh Interval	Select how often you want the ZyXEL Device to update this screen from the drop-down list box.
Connected Interface	This shows the name of the WAN interface that is currently connected.
Packets Sent	
Data	This indicates the number of transmitted packets on this interface.
Error	This indicates the number of frames with errors transmitted on this interface.
Drop	This indicates the number of outgoing packets dropped on this interface.
Packets Received	
Data	This indicates the number of received packets on this interface.
Error	This indicates the number of frames with errors received on this interface.
Drop	This indicates the number of received packets dropped on this interface.

18.3 The LAN Status Screen

Click **System Monitor > Traffic Status > LAN** to open the following screen. You can view the LAN traffic statistics in this screen.

Figure 111 System Monitor > Traffic Status > LAN

Refresh interval : 5 seconds ▾						
Interface		LAN1	LAN2	LAN3	LAN4	Wireless
Bytes Sent		8027614	0	0	0	2772
Bytes Received		1159174	0	0	0	3322
Interface		LAN1	LAN2	LAN3	LAN4	Wireless
Sent (Packet)	Data	11290	0	0	0	28
	Error	0	0	0	0	9
	Drop	0	0	0	0	0
Received (Packet)	Data	9452	0	0	0	27
	Error	0	0	0	0	0
	Drop	0	0	0	0	0

The following table describes the fields in this screen.

Table 70 System Monitor > Traffic Status > LAN

LABEL	DESCRIPTION
Refresh Interval	Select how often you want the ZyXEL Device to update this screen from the drop-down list box.
Interface	This shows the LAN or WLAN interface.
Bytes Sent	This indicates the number of bytes transmitted on this interface.
Bytes Received	This indicates the number of bytes received on this interface.
Interface	This shows the LAN or WLAN interface.
Sent (Packet)	
Data	This indicates the number of transmitted packets on this interface.
Error	This indicates the number of frames with errors transmitted on this interface.
Drop	This indicates the number of outgoing packets dropped on this interface.
Received (Packet)	
Data	This indicates the number of received packets on this interface.
Error	This indicates the number of frames with errors received on this interface.
Drop	This indicates the number of received packets dropped on this interface.

18.4 The NAT Status Screen

Click **System Monitor > Traffic Status > NAT** to open the following screen. You can view the NAT status of the ZyXEL Device's client(s) in this screen.

Figure 112 System Monitor > Traffic Status > NAT

Refresh interval : 5 seconds ▾			
Device Name	IP Address	MAC Address	No. of Open Session
twpc13774-02	192.168.1.58	00:24:21:7e:20:96	142
			Total : 142

The following table describes the fields in this screen.

Table 71 System Monitor > Traffic Status > NAT

LABEL	DESCRIPTION
Refresh Interval	Select how often you want the ZyXEL Device to update this screen from the drop-down list box.
Device Name	This shows the name of the client.
IP Address	This shows the IP address of the client.
MAC Address	This shows the MAC address of the client.
No. of Open Session	This shows the number of NAT sessions used by the client.

18.5 The 3G Backup Status Screen

Click **System Monitor > Traffic Status > 3G Backup** to open the following screen. You can view the 3G connection traffic statistics in this screen.

Figure 113 System Monitor > Traffic Status > 3G Backup

Status						
Sent : 0 Bytes				Received : 0 Bytes		
Refresh interval : 5 seconds ▾						
Connected Interface	Packets Sent			Packets Received		
	Data	Error	Drop	Data	Error	Drop
ppp9	0	0	0	0	0	0

The following table describes the fields in this screen.

Table 72 System Monitor > Traffic Status > 3G backup

LABEL	DESCRIPTION
Status	This shows the number of bytes received and sent through the 3G interface of the ZyXEL Device.
Refresh Interval	Select how often you want the ZyXEL Device to update this screen from the drop-down list box.
Connected Interface	This shows the name of the 3G connection interface that is currently connected.
Packets Sent	
Data	This indicates the number of transmitted packets on this interface.
Error	This indicates the number of frames with errors transmitted on this interface.
Drop	This indicates the number of outgoing packets dropped on this interface.
Packets Received	
Data	This indicates the number of received packets on this interface.
Error	This indicates the number of frames with errors received on this interface.
Drop	This indicates the number of received packets dropped on this interface.

18.6 The VoIP Status Screen

Click **System Monitor > VoIP Status** to open the following screen. You can view the VoIP traffic statistics in this screen.

Figure 114 System Monitor > VoIP Status

Refresh interval : 5 seconds ▾						
SIP Status						
Account	Registration	Last Registration	URI	Message Waiting	Last Incoming Number	Last Outgoing Number
SIP 1	Disabled	0:00:00	ChangeMe@ChangeMe	NO	N/A	N/A
SIP 2	Disabled	0:00:00	ChangeMe@ChangeMe	NO	N/A	N/A
Call Status						
Account	Duration			Status	Codec	Peer Number
SIP 1	0 Day(s), 0 Hour(s), 0 Minute(s), 0 Second(s)			Idle		None
SIP 2	0 Day(s), 0 Hour(s), 0 Minute(s), 0 Second(s)			Idle		None
Phone Status						
Account	Outgoing Number		Incoming Number			
Phone 1	ChangeMe		ChangeMe			
Phone 2	ChangeMe		ChangeMe			

The following table describes the fields in this screen.

Table 73 System Monitor > VoIP Status

LABEL	DESCRIPTION
Refresh Interval	Select how often you want the ZyXEL Device to update this screen from the drop-down list box.
SIP Status	
Account	This column displays each SIP account in the ZyXEL Device.
Registration	This field displays the current registration status of the SIP account. You can change this in the Status screen. Registered - The SIP account is registered with a SIP server. Not Registered - The last time the ZyXEL Device tried to register the SIP account with the SIP server, the attempt failed. The ZyXEL Device automatically tries to register the SIP account when you turn on the ZyXEL Device or when you activate it. Inactive - The SIP account is not active. You can activate it in VoIP > SIP > SIP Account .
Last Registration	This field displays the last time you successfully registered the SIP account. The field is blank if you never successfully registered this account.
URI	This field displays the account number and service domain of the SIP account. You can change these in the VoIP > SIP screens.
Message Waiting	This field indicates whether or not there are any messages waiting for the SIP account.
Last Incoming Number	This field displays the last number that called the SIP account. The field is blank if no number has ever dialed the SIP account.
Last Outgoing Number	This field displays the last number the SIP account called. The field is blank if the SIP account has never dialed a number.
Call Status	
Account	This column displays each SIP account in the ZyXEL Device.
Duration	This field displays how long the current call has lasted.
Status	This field displays the current state of the phone call. Idle - There are no current VoIP calls, incoming calls or outgoing calls being made. Dial - The callee's phone is ringing. Ring - The phone is ringing for an incoming VoIP call. Process - There is a VoIP call in progress. DISC - The callee's line is busy, the callee hung up or your phone was left off the hook.
Codec	This field displays what voice codec is being used for a current VoIP call through a phone port.
Peer Number	This field displays the SIP number of the party that is currently engaged in a VoIP call through a phone port.
Phone Status	

Table 73 System Monitor > VoIP Status (continued)

LABEL	DESCRIPTION
Account	This field displays the phone accounts of the ZyXEL Device.
Outgoing Number	This field displays the SIP number that you use to make calls on this phone port.
Incoming Number	This field displays the SIP number that you use to receive calls on this phone port.

User Account

19.1 Overview

You can configure system password for different user accounts in the **User Account** screen.

19.2 The User Account Screen

Use the **User Account** screen to configure system password.

Click **Maintenance > User Account** to open the following screen.

Figure 115 Maintenance > User Account

The screenshot shows a web-based configuration interface for user accounts. It includes a dropdown menu for selecting a user name (currently set to 'admin'), and three text input fields for entering the old password, a new password, and a confirmation of the new password. The interface is clean with a white background and grey borders for the input fields and buttons.

The following table describes the labels in this screen.

Table 74 Maintenance > User Account

LABEL	DESCRIPTION
User Name	You can configure the password for the admin or user account . Select admin or user from the drop-down list box.
Old Password	Type the default password or the existing password you use to access the system in this field.
New Password	Type your new system password (up to 30 characters). Note that as you type a password, the screen displays a (*) for each character you type. After you change the password, use the new password to access the ZyXEL Device.
Retype to Confirm	Type the new password again for confirmation.

Table 74 Maintenance > User Account (continued)

LABEL	DESCRIPTION
Apply	Click Apply to save your changes.
Cancel	Click Cancel to restore your previously saved settings.

Remote MGMT

20.1 Overview

Remote MGMT allows you to manage your ZyXEL Device from a remote location through the following interfaces:

- LAN and WLAN
- WAN only

Note: The ZyXEL Device is managed using the web configurator.

20.1.1 What You Need to Know

The following terms and concepts may help as you read this chapter

TR-064

TR-064 is a LAN-Side DSL CPE Configuration protocol defined by the DSL Forum. TR-064 is built on top of UPnP. It allows the users to use a TR-064 compliant CPE management application on their computers from the LAN to discover the CPE and configure user-specific parameters, such as the username and password.

SSH/SCP/SFTP

Secure Shell (SSH) is a secure communication protocol that combines authentication and data encryption to provide secure encrypted communication between two hosts over an unsecured network. The following file transfer methods use SSH:

- **Secure Copy (SC)** is a secure way of transferring files between computers. It uses port 22.
- **SSH File Transfer Protocol or Secure File Transfer Protocol (SFTP)** is an old way of transferring files between computers. It uses port 22.

20.2 The Remote MGMT Screen

Use this screen to decide what services you may use to access which ZyXEL Device interface. Click **Maintenance > Remote MGMT** to open the following screen.

Figure 116 Maintenance > Remote MGMT

Remote Management			
Services	LAN/WLAN	WAN	Port
HTTPS	<input checked="" type="checkbox"/> Enable	<input checked="" type="checkbox"/> Enable	<input type="text" value="443"/>
HTTP	<input checked="" type="checkbox"/> Enable	<input checked="" type="checkbox"/> Enable	<input type="text" value="80"/>
TELNET	<input checked="" type="checkbox"/> Enable	<input checked="" type="checkbox"/> Enable	<input type="text" value="23"/>
FTP	<input checked="" type="checkbox"/> Enable	<input checked="" type="checkbox"/> Enable	<input type="text" value="21"/>
SSH/SCP/SFTP	<input checked="" type="checkbox"/> Enable	<input checked="" type="checkbox"/> Enable	<input type="text" value="22"/>
ICMP	<input checked="" type="checkbox"/> Enable	<input type="checkbox"/> Enable	N/A
TR-064	<input checked="" type="checkbox"/> Enable	N/A	18888

The following table describes the fields in this screen.

Table 75 Maintenance > Remote MGMT

LABEL	DESCRIPTION
Services	This is the service you may use to access the ZyXEL Device.
LAN/WLAN	Select the Enable check box for the corresponding services that you want to allow access to the ZyXEL Device from the LAN and WLAN.
WAN	Select the Enable check box for the corresponding services that you want to allow access to the ZyXEL Device from the WAN.
Port	You may change the server port number for a service if needed, however you must use the same port number in order to use that service for remote management.
Apply	Click Apply to save your changes.
Cancel	Click Cancel to restore your previously saved settings.

System

21.1 Overview

You can configure system settings, including the host name, domain name and the inactivity time-out interval in the **System** screen.

21.1.1 What You Need to Know

The following terms and concepts may help as you read this chapter.

Domain Name

This is a network address that identifies the owner of a network connection. For example, in the network address "www.zyxel.com/support/files", the domain name is "www.zyxel.com".

21.2 The System Screen

Use the **System** screen to configure the system's host name, domain name, and inactivity time-out interval.

The **Host Name** is for identification purposes. However, because some ISPs check this name you should enter your computer's "Computer Name". Find the system name of your Windows computer.

In Windows XP, click **start**, **My Computer**, **View system information** and then click the **Computer Name** tab. Note the entry in the **Full computer name** field and enter it as the ZyXEL Device **System Name**.

Click **Maintenance > System** to open the following screen.

Figure 117 Maintenance > System

Host Name :	<input type="text" value="P-2612HNU-F1"/>
Domain Name :	<input type="text" value="P-2612HNU-F1"/>
Administrator Inactivity Timer :	<input type="text" value="0"/> (minutes, 0 means no timeout)
<input type="button" value="Apply"/> <input type="button" value="Cancel"/>	

The following table describes the labels in this screen.

Table 76 Maintenance > System

LABEL	DESCRIPTION
Host Name	Choose a descriptive name for identification purposes. It is recommended you enter your computer's "Computer name" in this field. This name can be up to 30 alphanumeric characters long. Spaces are not allowed, but dashes "-" and underscores "_" are accepted.
Domain Name	Enter the domain name (if you know it) here. If you leave this field blank, the ISP may assign a domain name via DHCP. The domain name entered by you is given priority over the ISP assigned domain name.
Administrator Inactivity Timer	Type how many minutes a management session (either via the web configurator) can be left idle before the session times out. The default is 5 minutes. After it times out you have to log in with your password again. Very long idle timeouts may have security risks. A value of "0" means a management session never times out, no matter how long it has been left idle (not recommended).
Apply	Click this to save your changes back to the ZyXEL Device.
Cancel	Click this to begin configuring this screen afresh.

Time Setting

22.1 Overview

You can configure the system's time and date in the **Time Setting** screen.

22.2 The Time Setting Screen

To change your ZyXEL Device's time and date, click **Maintenance > Time Setting**. The screen appears as shown. Use this screen to configure the ZyXEL Device's time based on your local time zone.

Figure 118 Maintenance > Time Setting

The following table describes the fields in this screen.

Table 77 Maintenance > System > Time Setting

LABEL	DESCRIPTION
Current Date/Time	
Current Time	This field displays the time of your ZyXEL Device.
Current Date	This field displays the date of your ZyXEL Device.
Time and Date Setup	

Table 77 Maintenance > System > Time Setting (continued)

LABEL	DESCRIPTION
Get from Time Server	The ZyXEL Device get the time and date from the time server you specified below.
Time Protocol	This shows the time service protocol that your time server sends when you turn on the ZyXEL Device.
Time Server Address	Enter the IP address or URL (up to 20 extended ASCII characters in length) of your time server. Check with your ISP/network administrator if you are unsure of this information.
Time Zone	Choose the time zone of your location. This will set the time difference between your time zone and Greenwich Mean Time (GMT).
Daylight Savings	Daylight saving is a period from late spring to early fall when many countries set their clocks ahead of normal local time by one hour to give more daytime light in the evening. Select this option if you use Daylight Saving Time.
Start Date	<p>Configure the day and time when Daylight Saving Time starts if you selected Daylight Savings. The o'clock field uses the 24 hour format. Here are a couple of examples:</p> <p>Daylight Saving Time starts in most parts of the United States on the second Sunday of March. Each time zone in the United States starts using Daylight Saving Time at 2 A.M. local time. So in the United States you would select Second, Sunday, March and type 2 in the o'clock field.</p> <p>Daylight Saving Time starts in the European Union on the last Sunday of March. All of the time zones in the European Union start using Daylight Saving Time at the same moment (1 A.M. GMT or UTC). So in the European Union you would select Last, Sunday, March. The time you type in the o'clock field depends on your time zone. In Germany for instance, you would type 2 because Germany's time zone is one hour ahead of GMT or UTC (GMT+1).</p>
End Date	<p>Configure the day and time when Daylight Saving Time ends if you selected Daylight Savings. The o'clock field uses the 24 hour format. Here are a couple of examples:</p> <p>Daylight Saving Time ends in the United States on the first Sunday of November. Each time zone in the United States stops using Daylight Saving Time at 2 A.M. local time. So in the United States you would select First, Sunday, November and type 2 in the o'clock field.</p> <p>Daylight Saving Time ends in the European Union on the last Sunday of October. All of the time zones in the European Union stop using Daylight Saving Time at the same moment (1 A.M. GMT or UTC). So in the European Union you would select Last, Sunday, October. The time you type in the o'clock field depends on your time zone. In Germany for instance, you would type 2 because Germany's time zone is one hour ahead of GMT or UTC (GMT+1).</p>
Apply	Click Apply to save your changes.
Reset	Click Reset to begin configuring this screen afresh.

Log Setting

23.1 Overview

You can configure where the ZyXEL Device sends logs and which logs and/or immediate alerts the ZyXEL Device records in the **Log Setting** screen.

23.2 The Log Setting Screen

To change your ZyXEL Device's log settings, click **Maintenance > Log Setting**. The screen appears as shown.

Figure 119 Maintenance > Log Setting

Syslog Logging

Syslog Logging : Enable Disable

Syslog Server : (IP Address)

UDP Port : (Server Port)

Active Log and Select Level

Log Category	Log Level
VoIP	
<input type="checkbox"/> VoIP-Call Statistics	ALL
<input type="checkbox"/> VoIP-SIP Call Signaling	ALL
<input type="checkbox"/> VoIP-SIP Registrations	ALL
<input type="checkbox"/> VoIP-Phone Event	ALL
<input type="checkbox"/> VoIP-Misc	ALL
System	
<input type="checkbox"/> WAN-DHCP	ALL
<input type="checkbox"/> xDSL	ALL
<input type="checkbox"/> ETHER	ALL
<input type="checkbox"/> System Maintenance	ALL
<input type="checkbox"/> Remote Management	ALL
<input type="checkbox"/> TR069	ALL
<input type="checkbox"/> NTP	ALL
<input type="checkbox"/> DDNS	ALL
<input type="checkbox"/> NAT	ALL

Apply Cancel

The following table describes the fields in this screen.

Table 78 Maintenance > Log Setting

LABEL	DESCRIPTION
Syslog Logging	The ZyXEL Device sends a log to an external syslog server. Select the Enable check box to enable syslog logging.
Syslog Server	Enter the server name or IP address of the syslog server that will log the selected categories of logs.
UDP Port	Enter the port number used by the syslog server.
Active Log and Select Level	
Log Category	Select the categories of logs that you want to record.
Log Level	Select the severity level of logs that you want to record. If you want to record all logs, select ALL .
Apply	Click Apply to save your changes.
Cancel	Click Cancel to restore your previously saved settings.

Firmware Upgrade

24.1 Overview

This chapter explains how to upload new firmware to your ZyXEL Device. You can download new firmware releases from your nearest ZyXEL FTP site (or www.zyxel.com) to use to upgrade your device's performance.

Only use firmware for your device's specific model. Refer to the label on the bottom of your ZyXEL Device.

24.2 The Firmware Upgrade Screen

Click **Maintenance > Firmware Upgrade** to open the following screen. The upload process uses HTTP (Hypertext Transfer Protocol) and may take up to two minutes. After a successful upload, the system will reboot.

Do NOT turn off the ZyXEL Device while firmware upload is in progress!

Figure 120 Maintenance > Firmware Upgrade

The following table describes the labels in this screen.

Table 79 Maintenance > Firmware Upgrade

LABEL	DESCRIPTION
Current Firmware Version	This is the present Firmware version.
File Path	Type in the location of the file you want to upload in this field or click Browse ... to find it.

Table 79 Maintenance > Firmware Upgrade

LABEL	DESCRIPTION
Browse...	Click this to find the .bin file you want to upload. Remember that you must decompress compressed (.zip) files before you can upload them.
Upload	Click this to begin the upload process. This process may take up to two minutes.

After you see the firmware updating screen, wait two minutes before logging into the ZyXEL Device again.

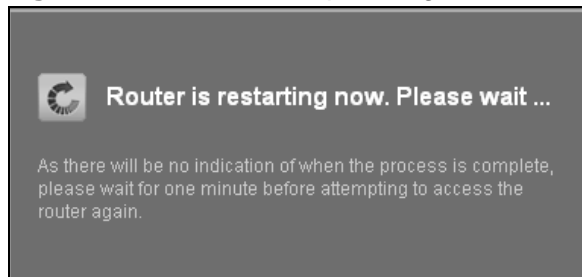
Figure 121 Firmware Uploading

The ZyXEL Device automatically restarts in this time causing a temporary network disconnect. In some operating systems, you may see the following icon on your desktop.

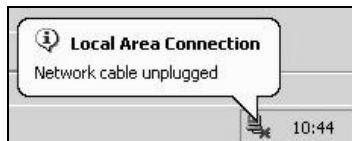
Figure 122 Network Temporarily Disconnected

After two minutes, log in again and check your new firmware version in the **Status** screen.

If the upload was not successful, an error screen will appear. Click **OK** to go back to the **Firmware Upgrade** screen.

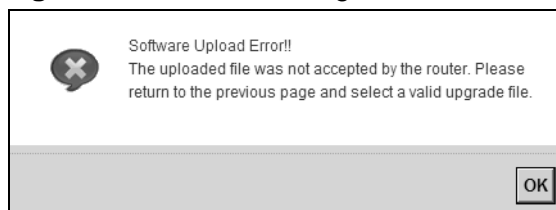
Figure 123 Error Message

Backup/Restore

25.1 Overview

The **Backup/Restore** screen allows you to backup and restore device configurations. You can also reset your device settings back to the factory default.

25.2 The Backup/Restore Screen

Click **Maintenance > Backup/Restore**. Information related to factory defaults, backup configuration, and restoring configuration appears in this screen, as shown next.

Figure 124 Maintenance > Backup/Restore

Backup Configuration

Click Backup to save the current configuration of your system to your computer.

Restore Configuration

To restore a previously saved configuration file to your system, browse to the location of the configuration file and click Upload.

FilePath :

Back to Factory Defaults

Click Reset to clear all user-entered configuration information and return to factory defaults. After resetting, the

- LAN IP address will be 192.168.1.1
- DHCP will be reset to server

Backup Configuration

Backup Configuration allows you to back up (save) the ZyXEL Device's current configuration to a file on your computer. Once your ZyXEL Device is configured and functioning properly, it is highly recommended that you back up your configuration file before making configuration changes. The backup configuration file will be useful in case you need to return to your previous settings.

Click **Backup** to save the ZyXEL Device's current configuration to your computer.

Restore Configuration

Restore Configuration allows you to upload a new or previously saved configuration file from your computer to your ZyXEL Device.

Table 80 Restore Configuration

LABEL	DESCRIPTION
File Path	Type in the location of the file you want to upload in this field or click Browse ... to find it.
Browse...	Click this to find the file you want to upload. Remember that you must decompress compressed (.ZIP) files before you can upload them.
Upload	Click this to begin the upload process.
Reset	Click this to reset your device settings back to the factory default.

Do not turn off the ZyXEL Device while configuration file upload is in progress.

After the ZyXEL Device configuration has been restored successfully, the login screen appears. Login again to restart the ZyXEL Device.

The ZyXEL Device automatically restarts in this time causing a temporary network disconnect. In some operating systems, you may see the following icon on your desktop.

Figure 125 Network Temporarily Disconnected



If you restore the default configuration, you may need to change the IP address of your computer to be in the same subnet as that of the default device IP address (192.168.1.1). See [Appendix B on page 323](#) for details on how to set up your computer's IP address.

If the upload was not successful, an error screen will appear. Click **OK** to go back to the **Configuration** screen.

Reset to Factory Defaults

Click the **Reset** button to clear all user-entered configuration information and return the ZyXEL Device to its factory defaults. The following warning screen appears.

Figure 126 Reset Warning Message

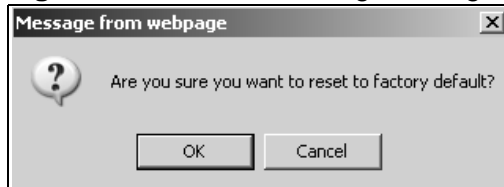
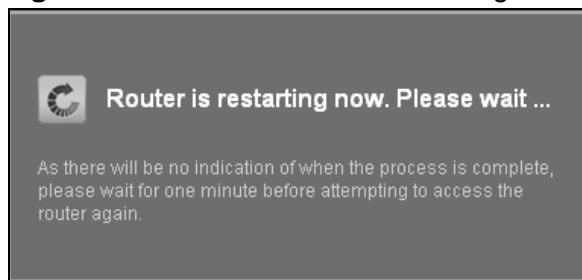

Figure 127 Reset In Process Message



You can also press the **RESET** button on the rear panel to reset the factory defaults of your ZyXEL Device. Refer to [Section 1.7 on page 28](#) for more information on the **RESET** button.

25.3 The Reboot Screen

System restart allows you to reboot the ZyXEL Device remotely without turning the power off. You may need to do this if the ZyXEL Device hangs, for example.

Click **Maintenance > Reboot**. Click the **Reboot** button to have the ZyXEL Device reboot. This does not affect the ZyXEL Device's configuration.

Diagnostic

26.1 Overview

You can use different diagnostic methods to test a connection and see the detailed information. These read-only screens display information to help you identify problems with the ZyXEL Device.

26.1.1 What You Can Do in this Chapter

- Use the **Ping** screen to ping an IP address and see the ping statistics ([Section 26.2 on page 287](#)).
- Use the **DSL Line** screen to check or reset your DSL connection ([Section 26.3 on page 288](#)).

26.2 The Ping Screen

Use this screen to ping an IP address. Click **Maintenance > Diagnostic** to open the **Ping** screen shown next.

Figure 128 Maintenance > Diagnostic > Ping

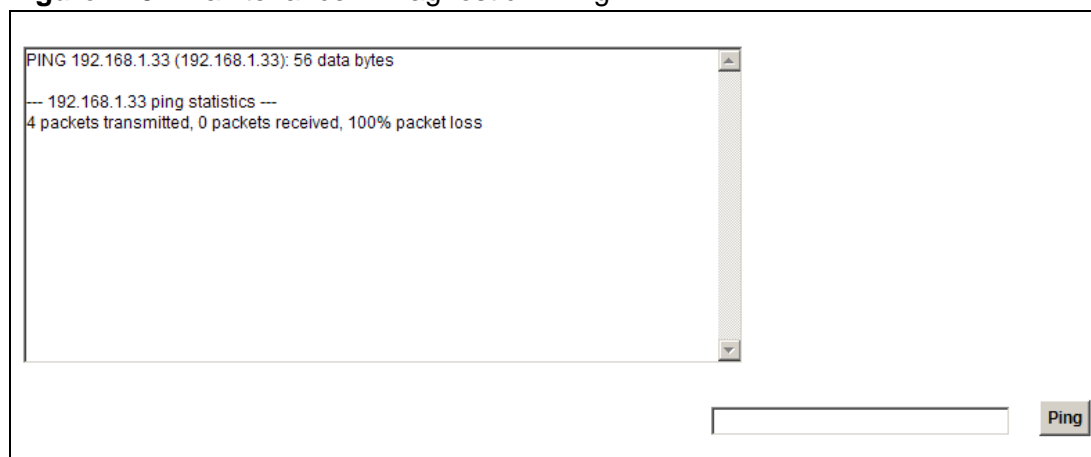

The following table describes the fields in this screen.

Table 81 Maintenance > Diagnostic > Ping

LABEL	DESCRIPTION
Ping	Type the IP address of a computer that you want to ping in order to test a connection. Click Ping and the ping statistics will show in the diagnostic .

26.3 The DSL Line Screen

Click **Maintenance > Diagnostic > DSL Line** to open the screen shown next.

Figure 129 Maintenance > Diagnostic > DSL Line

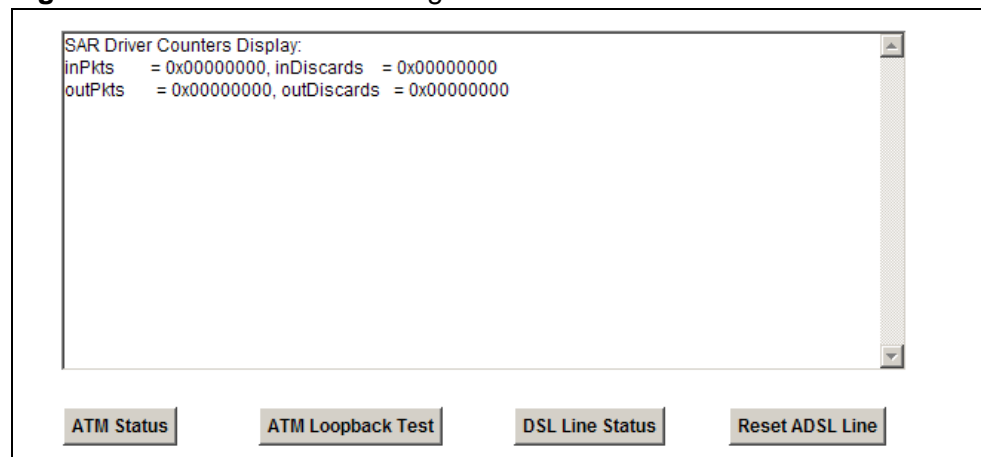

The following table describes the fields in this screen.

Table 82 Maintenance > Diagnostic > DSL Line

ITEM	DESCRIPTION
ATM Status	<p>Click this button to view your DSL connection's Asynchronous Transfer Mode (ATM) statistics. ATM is a networking technology that provides high-speed data transfer. ATM uses fixed-size packets of information called cells. With ATM, a high QoS (Quality of Service) can be guaranteed.</p> <p>The (Segmentation and Reassembly) SAR driver translates packets into ATM cells. It also receives ATM cells and reassembles them into packets.</p> <p>These counters are set back to zero whenever the device starts up.</p> <p>inPkts is the number of good ATM cells that have been received.</p> <p>inDiscards is the number of received ATM cells that were rejected.</p> <p>outPkts is the number of ATM cells that have been sent.</p> <p>outDiscards is the number of ATM cells sent that were rejected.</p>
ATM Loopback Test	<p>Click this button to start the ATM loopback test. Make sure you have configured at least one PVC with proper VPIs/VCIs before you begin this test. The ZyXEL Device sends an OAM F5 packet to the DSLAM/ATM switch and then returns it (loops it back) to the ZyXEL Device. The ATM loopback test is useful for troubleshooting problems with the DSLAM and ATM network.</p>

Table 82 Maintenance > Diagnostic > DSL Line

ITEM	DESCRIPTION
DSL Line Status	<p>Click this button to view statistics about the DSL connections.</p> <ol style="list-style-type: none"> 1. noise margin downstream is the signal to noise ratio for the downstream part of the connection (coming into the ZyXEL Device from the ISP). It is measured in decibels. The higher the number the more signal and less noise there is. 2. output power upstream is the amount of power (in decibels) that the ZyXEL Device is using to transmit to the ISP. 3. attenuation downstream is the reduction in amplitude (in decibels) of the DSL signal coming into the ZyXEL Device from the ISP. <p>Discrete Multi-Tone (DMT) modulation divides up a line's bandwidth into sub-carriers (sub-channels) of 4.3125 KHz each called tones. The rest of the display is the line's bit allocation. This is displayed as the number (in hexadecimal format) of bits transmitted for each tone. This can be used to determine the quality of the connection, whether a given sub-carrier loop has sufficient margins to support certain ADSL transmission rates, and possibly to determine whether particular specific types of interference or line attenuation exist. Refer to the ITU-T G.992.1 recommendation for more information on DMT.</p> <p>The better (or shorter) the line, the higher the number of bits transmitted for a DMT tone. The maximum number of bits that can be transmitted per DMT tone is 15. There will be some tones without any bits as there has to be space between the upstream and downstream channels.</p>
Reset ADSL Line	<p>Click this button to reinitialize the ADSL line. The large text box above then displays the progress and results of this operation, for example:</p> <pre> "Start to reset ADSL Loading ADSL modem F/W... Reset ADSL Line Successfully!" </pre>

Troubleshooting

27.1 Overview

This chapter offers some suggestions to solve problems you might encounter. The potential problems are divided into the following categories.

- [Power, Hardware Connections, and LEDs](#)
- [ZyXEL Device Access and Login](#)
- [Internet Access](#)
- [Wireless Internet Access](#)
- [Phone Calls and VoIP](#)
- [USB Device Connection](#)
- [UPnP](#)

27.2 Power, Hardware Connections, and LEDs

The ZyXEL Device does not turn on. None of the LEDs turn on.

- 1 Make sure the ZyXEL Device is turned on.
- 2 Make sure you are using the power adaptor or cord included with the ZyXEL Device.
- 3 Make sure the power adaptor or cord is connected to the ZyXEL Device and plugged in to an appropriate power source. Make sure the power source is turned on.
- 4 Turn the ZyXEL Device off and on.
- 5 If the problem continues, contact the vendor.

One of the LEDs does not behave as expected.

- 1 Make sure you understand the normal behavior of the LED. See [Section 1.6 on page 26](#).
- 2 Check the hardware connections. See the Quick Start Guide.
- 3 Inspect your cables for damage. Contact the vendor to replace any damaged cables.
- 4 Turn the ZyXEL Device off and on.
- 5 If the problem continues, contact the vendor.

27.3 ZyXEL Device Access and Login

I forgot the IP address for the ZyXEL Device.

- 1 The default IP address is 192.168.1.1.
- 2 If you changed the IP address and have forgotten it, you might get the IP address of the ZyXEL Device by looking up the IP address of the default gateway for your computer. To do this in most Windows computers, click **Start > Run**, enter **cmd**, and then enter **ipconfig**. The IP address of the **Default Gateway** might be the IP address of the ZyXEL Device (it depends on the network), so enter this IP address in your Internet browser.
- 3 If this does not work, you have to reset the device to its factory defaults. See [Section 1.7 on page 28](#).

I forgot the password.

- 1 The default admin password is **1234** and the default user password is **user**.
- 2 If this does not work, you have to reset the device to its factory defaults. See [Section 1.7 on page 28](#).

I cannot see or access the **Login** screen in the web configurator.

- 1 Make sure you are using the correct IP address.
 - The default IP address is 192.168.1.1.
 - If you changed the IP address ([Section on page 166](#)), use the new IP address.
 - If you changed the IP address and have forgotten it, see the troubleshooting suggestions for [I forgot the IP address for the ZyXEL Device](#).
- 2 Check the hardware connections, and make sure the LEDs are behaving as expected. See the Quick Start Guide.
- 3 Make sure your Internet browser does not block pop-up windows and has JavaScript and Java enabled. See [Appendix C on page 353](#).
- 4 Reset the device to its factory defaults, and try to access the ZyXEL Device with the default IP address. See [Section 1.7 on page 28](#).
- 5 If the problem continues, contact the network administrator or vendor, or try one of the advanced suggestions.

Advanced Suggestions

- Try to access the ZyXEL Device using another service, such as Telnet. If you can access the ZyXEL Device, check the remote management settings and firewall rules to find out why the ZyXEL Device does not respond to HTTP.
- If your computer is connected to the **WAN** port or is connected wirelessly, use a computer that is connected to a **ETHERNET** port.

I can see the **Login** screen, but I cannot log in to the ZyXEL Device.

- 1 Make sure you have entered the user name and password correctly. The default user name is **admin**. These fields are case-sensitive, so make sure [Caps Lock] is not on.
- 2 You cannot log in to the web configurator while someone is using Telnet to access the ZyXEL Device. Log out of the ZyXEL Device in the other session, or ask the person who is logged in to log out.
- 3 Turn the ZyXEL Device off and on.

- 4 If this does not work, you have to reset the device to its factory defaults. See [Section 27.2 on page 291](#).

I cannot Telnet to the ZyXEL Device.

See the troubleshooting suggestions for [I cannot see or access the Login screen in the web configurator](#). Ignore the suggestions about your browser.

I cannot use FTP to upload / download the configuration file. / I cannot use FTP to upload new firmware.

See the troubleshooting suggestions for [I cannot see or access the Login screen in the web configurator](#). Ignore the suggestions about your browser.

27.4 Internet Access

I cannot access the Internet.

- 1 Check the hardware connections, and make sure the LEDs are behaving as expected. See the Quick Start Guide and [Section 1.6 on page 26](#).
- 2 Make sure you entered your ISP account information correctly. These fields are case-sensitive, so make sure [Caps Lock] is not on.
- 3 If you are trying to access the Internet wirelessly, make sure the wireless settings in the wireless client are the same as the settings in the AP.
- 4 If you are trying to access the Internet wirelessly, make sure you have enabled the wireless LAN by the **WPS/WLAN** button or the **Network Setting > Wireless > General** screen.
- 5 Disconnect all the cables from your device, and follow the directions in the Quick Start Guide again.
- 6 If the problem continues, contact your ISP.

I cannot access the Internet through a DSL connection.

- 1 Check if you set the **DSL/WAN** switch (on the back of the ZyXEL Device) to the **DSL** side to have the ZyXEL Device use the DSL port for Internet access.
- 2 Make sure you configured a proper DSL WAN connection with the Internet account information provided by your ISP.
- 3 If you set up a WAN connection using bridging service (all LAN ports and WLAN BSSs are bridged to one WAN connection), make sure you turn off the DHCP feature in the **Home Networking** screen to have the clients get WAN IP addresses directly from your ISP's DHCP server.

I cannot access the Internet through an Ethernet WAN connection.

- 1 Check if you set the **DSL/WAN** switch (on the back of the ZyXEL Device) to the **WAN** side to have the ZyXEL Device use the Ethernet WAN port for Internet access.
- 2 Make sure you connect the Ethernet WAN port to a DSL modem or router in your network.
- 3 Make sure you configured a proper Ethernet WAN connection with the Internet account information provided by your ISP.
- 4 If you set up a WAN connection using bridging service (all LAN ports and WLAN BSSs are bridged to one WAN connection), make sure you turn off the DHCP feature in the **Home Networking** screen to have the clients get WAN IP addresses directly from your ISP's DHCP server.

I cannot connect to the Internet using a second DSL connection.

ADSL and VDSL connections cannot work at the same time. You can only use one type of DSL connection, either ADSL or VDSL connection at one time.

I cannot create multiple connections of the same type.

Your WAN interface must enable VLAN and fill each WAN connection with different VLAN IDs.

I cannot access the Internet anymore. I had access to the Internet (with the ZyXEL Device), but my Internet connection is not available anymore.

- 1 Check the hardware connections, and make sure the LEDs are behaving as expected. See the Quick Start Guide and [Section 1.6 on page 26](#).
- 2 Turn the ZyXEL Device off and on.
- 3 If the problem continues, contact your ISP.

The Internet connection is slow or intermittent.

- 1 There might be a lot of traffic on the network. Look at the LEDs, and check [Section 1.6 on page 26](#). If the ZyXEL Device is sending or receiving a lot of information, try closing some programs that use the Internet, especially peer-to-peer applications.
- 2 Turn the ZyXEL Device off and on.
- 3 If the problem continues, contact the network administrator or vendor, or try one of the advanced suggestions.

Advanced Suggestions

- Check the settings for QoS. If it is disabled, you might consider activating it. If it is enabled, you might consider raising or lowering the priority for some applications.

27.5 Wireless Internet Access

What factors may cause intermittent or unstabled wireless connection? How can I solve this problem?

The following factors may cause interference:

- Obstacles: walls, ceilings, furniture, and so on.
- Building Materials: metal doors, aluminum studs.
- Electrical devices: microwaves, monitors, electric motors, cordless phones, and other wireless devices.

To optimize the speed and quality of your wireless connection, you can:

- Move your wireless device closer to the AP if the signal strength is low.
- Reduce wireless interference that may be caused by other wireless networks or surrounding wireless electronics such as cordless phones.
- Place the AP where there are minimum obstacles (such as walls and ceilings) between the AP and the wireless client.
- Reduce the number of wireless clients connecting to the same AP simultaneously, or add additional APs if necessary.
- Try closing some programs that use the Internet, especially peer-to-peer applications. If the wireless client is sending or receiving a lot of information, it may have too many programs open that use the Internet.
- Position the antennas for best reception. If the AP is placed on a table or floor, point the antennas upwards. If the AP is placed at a high position, point the antennas downwards. Try pointing the antennas in different directions and check which provides the strongest signal to the wireless clients.

What is a Server Set ID (SSID)?

An SSID is a name that uniquely identifies a wireless network. The AP and all the clients within a wireless network must use the same SSID.

What wireless security modes does my ZyXEL Device support?

Wireless security is vital to your network. It protects communications between wireless stations, access points and the wired network.

The available security modes in your ZyXEL device are as follows:

- **WPA2-PSK:** (recommended) This uses a pre-shared key with the WPA2 standard.
- **WPA-PSK:** This has the device use either WPA-PSK or WPA2-PSK depending on which security mode the wireless client uses.
- **WPA2:** WPA2 (IEEE 802.11i) is a wireless security standard that defines stronger encryption, authentication and key management than WPA. It requires the use of a RADIUS server and is mostly used in business networks.

- **WPA:** Wi-Fi Protected Access (WPA) is a subset of the IEEE 802.11i standard. It requires the use of a RADIUS server and is mostly used in business networks.
- **WEP:** Wired Equivalent Privacy (WEP) encryption scrambles the data transmitted between the wireless stations and the access points to keep network communications private.

27.6 Phone Calls and VoIP

The telephone port won't work or the telephone lacks a dial tone.

- 1 Check the telephone connections and telephone wire.

I can access the Internet, but cannot make VoIP calls.

- 1 The **PHONE** light should come on. Make sure that your telephone is connected to the **PHONE** port.
- 2 You can also check the VoIP status in the **System Info** screen.
- 3 If the VoIP settings are correct, use speed dial to make peer-to-peer calls. If you can make a call using speed dial, there may be something wrong with the SIP server, contact your VoIP service provider.

27.7 USB Device Connection

The ZyXEL Device fails to detect my USB device.

- 1 Disconnect the USB device.
- 2 Reboot the ZyXEL Device.
- 3 If you are connecting a USB hard drive that comes with an external power supply, make sure it is connected to an appropriate power source that is on.

- 4 Re-connect your USB device to the ZyXEL Device.

27.8 UPnP

When using UPnP and the ZyXEL Device reboots, my computer cannot detect UPnP and refresh **My Network Places > Local Network**.

- 1 Disconnect the Ethernet cable from the ZyXEL Device's LAN port or from your computer.
- 2 Re-connect the Ethernet cable.

The **Local Area Connection** icon for UPnP disappears in the screen.

Restart your computer.

I cannot open special applications such as white board, file transfer and video when I use the MSN messenger.

- 1 Wait more than three minutes.
- 2 Restart the applications.

Product Specifications

The following tables summarize the ZyXEL Device's hardware and firmware features.

Hardware Specifications

Table 83 Hardware Specifications

Dimensions	256 (W) x 145 (D) x 40 (H) mm
Weight	457 g
Power Specification	12V 1.5A DC
Built-in Switch	Four auto-negotiating, auto MDI/MDI-X 10/100/1000 Mbps RJ-45 Ethernet ports
DSL Port	P-2612HNU-F1: One RJ-11 DSL port P-2612HNU-F3: One RJ-45 DSL port
WAN Port	One RJ-45 WAN port
PHONE Ports	2 RJ-11 FXS POTS ports
RESET Button	Restores factory defaults
WLAN/WPS Button	1 second: Turn on or off WLAN 5 seconds: Start WPS
USB Port	Two USB v2.0 ports for file sharing or print server setup
DSL/WAN Switch	Switch for DSL/Gigabit Ethernet WAN
Antenna	Two 2 dBi external fixed antennas, 2 x 2
Operation Temperature	0° C ~ 40° C
Storage Temperature	-30° ~ 60° C
Operation Humidity	20% ~ 95% RH
Storage Humidity	20% ~ 95% RH
Distance between the centers of the holes (for wall-mounting) on the device's back	137.20mm
Screw size for wall-mounting	M4 tap

Firmware Specifications

Table 84 Firmware Specifications

Default IP Address	192.168.1.1
Default Subnet Mask	255.255.255.0 (24 bits)
Default User Name	admin
Default Password	1234
DHCP Server IP Pool	Starting Address: 192.168.1.33 Size: 32
Static DHCP Addresses	10
Static Routes	16
Device Management	Use the web configurator to easily configure the rich range of features on the ZyXEL Device.
Wireless Functionality (wireless devices only)	Allow the IEEE 802.11a, IEEE 802.11n, IEEE 802.11b and/or IEEE 802.11g wireless clients to connect to the ZyXEL Device wirelessly. Enable wireless security (WEP, WPA(2), WPA(2)-PSK) and/or MAC filtering to protect your wireless network.
Firmware Upgrade	Download new firmware (when available) from the ZyXEL web site and use the web configurator, an HTTP/FTP/SCP/SFTP tool to put it on the ZyXEL Device. Note: Only upload firmware for your specific model!
Configuration Backup & Restoration	Make a copy of the ZyXEL Device's configuration. You can put it back on the ZyXEL Device later if you decide to revert back to an earlier configuration.
Network Address Translation (NAT)	Each computer on your network must have its own unique IP address. Use NAT to convert your public IP address(es) to multiple private IP addresses for the computers on your network.
Port Forwarding	If you have a server (mail or web server for example) on your network, you can use this feature to let people access it from the Internet.
DHCP (Dynamic Host Configuration Protocol)	Use this feature to have the ZyXEL Device assign IP addresses, an IP default gateway and DNS servers to computers on your network.
Dynamic DNS Support	With Dynamic DNS (Domain Name System) support, you can use a fixed URL, www.zyxel.com for example, with a dynamic IP address. You must register for this service with a Dynamic DNS service provider.
IP Multicast	IP multicast is used to send traffic to a specific group of computers. The ZyXEL Device supports versions 1 and 2 of IGMP (Internet Group Management Protocol) used to join multicast groups (see RFC 2236).
Time and Date	Get the current time and date from an external server when you turn on your ZyXEL Device. You can also set the time manually. These dates and times are then used in logs.

Table 84 Firmware Specifications (continued)

Logs	Use logs for troubleshooting. You can send logs from the ZyXEL Device to an external syslog server.
Universal Plug and Play (UPnP)	A UPnP-enabled device can dynamically join a network, obtain an IP address and convey its capabilities to other devices on the network.
Firewall	Your device has a stateful inspection firewall with DoS (Denial of Service) protection. By default, when the firewall is activated, all incoming traffic from the WAN to the LAN is blocked unless it is initiated from the LAN. The firewall supports TCP/UDP inspection, DoS detection and prevention, real time alerts, reports and logs.
QoS (Quality of Service)	You can efficiently manage traffic on your network by reserving bandwidth and giving priority to certain types of traffic and/or to particular computers.
Remote Management	This allows you to decide whether a service (HTTP or FTP traffic for example) from a computer on a network (LAN or WAN for example) can access the ZyXEL Device.
PPPoE Support (RFC2516)	PPPoE (Point-to-Point Protocol over Ethernet) emulates a dial-up connection. It allows your ISP to use their existing network configuration with newer broadband technologies such as ADSL. The PPPoE driver on your device is transparent to the computers on the LAN, which see only Ethernet and are not aware of PPPoE thus saving you from having to manage PPPoE clients on individual computers.
Multiple PVC (Permanent Virtual Circuits) Support	Your device supports one Permanent Virtual Circuits (PVCs).
Packet Filters	Your device's packet filtering function allows added network security and management.
ADSL Standards	Support ITU G.992.1 G.dmt EOC specified in ITU-T G.992.1 ADSL2 G.dmt.bis (G.992.3) ADSL 2/2+ AnnexM ADSL2+ (G.992.5) Reach-Extended ADSL (RE ADSL) SRA (Seamless Rate Adaptation) Auto-negotiating rate adaptation ADSL physical connection AAL5 (ATM Adaptation Layer type 5) Multi-protocol over AAL5 (RFC 2684) PPP over Ethernet (RFC 2516) Multiple PPPoE LLC-based multiplexing I.610 F4/F5 OAM

Table 84 Firmware Specifications (continued)

Other Protocol Support	Transparent bridging for unsupported network layer protocols ICMP ATM QoS IP Multicasting IGMP v1, v2 IGMP Proxy/Snooping
Management	Embedded Web Configurator CLI (Command Line Interpreter) Firmware upgrade and configuration file restore through Web/FTP/SCP/SFTP Telnet for remote management Remote Management Control: Telnet, FTP, Web, SNMP, SSH/SCP/SFTP, and ICMP. Remote Firmware Upgrade Syslog TR-069 TR-064

Voice Specifications

Note: To take full advantage of the supplementary phone services available through the ZyXEL Device's phone port, you may need to subscribe to the services from your VoIP service provider.

Note: Not all features are supported by all service providers. Consult your service provider for more information.

Table 85 Voice Features

Call Return	With call return, you can place a call to the last number that called you (either answered or missed). The last incoming call can be through either SIP or PSTN.
Country Code	Phone standards and settings differ from one country to another, so the settings on your ZyXEL Device must be configured to match those of the country you are in. The country code feature allows you to do this by selecting the country from a list rather than changing each setting manually. Configure the country code feature when you move the ZyXEL Device from one country to another.
Do not Disturb (DnD)	This feature allows you to set your phone not to ring when someone calls you. You can set each phone independently using its keypad, or configure global settings for all phones using the command line interpreter.

Table 85 Voice Features

Phone config	The phone config table allows you to customize the phone keypad combinations you use to access certain features on the ZyXEL Device, such as call waiting, call return, and call forward. The phone config table is configurable in command interpreter mode.
Call waiting	This feature allows you to hear an alert when you are already using the phone and another person calls you. You can then either reject the new incoming call, put your current call on hold and receive the new incoming call, or end the current call and receive the new incoming call.
Call forwarding	With this feature, you can set the ZyXEL Device to forward calls to a specified number, either unconditionally (always), when your number is busy, or when you do not answer. You can also forward incoming calls from one specified number to another.
Caller ID	The ZyXEL Device supports caller ID, which allows you to see the originating number of an incoming call (on a phone with a suitable display).
Dynamic Jitter Buffer	The built-in adaptive buffer helps to smooth out the variations in delay (jitter) for voice traffic. This helps ensure good voice quality for your conversations.
Multiple SIP Accounts	You can simultaneously use multiple voice (SIP) accounts and assign them to the telephone port.
Multiple Voice Channels	Your device can simultaneously handle multiple voice channels (telephone calls). Additionally you can answer an incoming phone call on a VoIP account, even while someone else is using the account for a phone call.
Voice Activity Detection/Silence Suppression	Voice Activity Detection (VAD) reduces the bandwidth that a call uses by not transmitting when you are not speaking.
Comfort Noise Generation	Your device generates background noise to fill moments of silence when the other device in a call stops transmitting because the other party is not speaking (as total silence could easily be mistaken for a lost connection).
Echo Cancellation	Your device supports G.168, an ITU-T standard for eliminating the echo caused by the sound of your voice reverberating in the telephone receiver while you talk.

Table 85 Voice Features

QoS (Quality of Service)	Quality of Service (QoS) mechanisms help to provide better service on a per-flow basis. Your device supports Type of Service (ToS) tagging and Differentiated Services (DiffServ) tagging. This allows the device to tag voice frames so they can be prioritized over the network.
Other Voice Features	<p>SIP version 2 (Session Initiation Protocol RFC 3261)</p> <p>SDP (Session Description Protocol RFC 2327)</p> <p>RTP/RTCP (RFC 3550)</p> <p>RTP/AV Profile (RFC 3551)</p> <p>Voice codecs (coder/decoders) G.711, G.729ab, G.726, G.722</p> <p>Fax and data modem discrimination</p> <p>DTMF Detection and Generation</p> <p>DTMF: In-band and Out-band traffic (RFC 2833), (PCM), (SIP INFO)</p> <p>Point-to-point call establishment between two IADs</p> <p>Quick dialing through predefined phone book, which maps the phone dialing number and destination URL.</p> <p>Flexible Dial Plan (RFC3525 section 7.1.14)</p>

Wireless Features

Table 86 Wireless Features

External Antenna	The ZyXEL Device is equipped with two fixed antennas to provide a clear radio signal between the wireless stations and the access points.
Multiple SSID	Multiple SSID allows the ZyXEL Device to operate up to 4 different wireless networks simultaneously, each with independently configurable wireless and security settings.
MAC Address Filtering	Your device can check the MAC addresses of clients against a list of allowed MAC addresses.
WEP Encryption	WEP (Wired Equivalent Privacy) encrypts data frames before transmitting over the wireless network to help keep network communications private.
Wi-Fi Protected Access	Wi-Fi Protected Access (WPA) is a subset of the IEEE 802.11i security standard. Key differences between WPA and WEP are user authentication and improved data encryption.
WPA2	WPA 2 is a wireless security standard that defines stronger encryption, authentication and key management than WPA.

Table 86 Wireless Features

WPS	Wi-Fi Protected Setup
Other Wireless Features	<p>IEEE 802.11n Compliance</p> <p>Frequency Range: 802.11b/g/n ISM Band: 2.4 GHz; 802.11a ISM Band: 5 GHz</p> <p>Advanced Orthogonal Frequency Division Multiplexing (OFDM)</p> <p>Turn on-off WLAN by WLAN button (press the WLAN button for one second to turn the WLAN on or turn off; five seconds to turn on WPS)</p> <p>IEEE 802.11i</p> <p>IEEE 802.11e</p> <p>Wired Equivalent Privacy (WEP) Data Encryption 64/128 bit</p> <p>WLAN bridge to LAN</p> <p>WLAN bridge to DSL/Ethernet WAN</p> <p>IEEE 802.1x</p> <p>External RADIUS server</p> <p>WLAN Scheduling</p>

The following list, which is not exhaustive, illustrates the standards supported in the ZyXEL Device.

Table 87 Standards Supported

STANDARD	DESCRIPTION
RFC 867	Daytime Protocol
RFC 868	Time Protocol
RFC 1112	IGMP v1
RFC 1305	Network Time Protocol (NTP version 3)
RFC 1483	Multiprotocol Encapsulation over ATM Adaptation Layer 5
RFC 1631	IP Network Address Translator (NAT)
RFC 1661	The Point-to-Point Protocol (PPP)
RFC 2236	Internet Group Management Protocol, Version 2
RFC 2516	A Method for Transmitting PPP Over Ethernet (PPPoE)
RFC 2684	Multiprotocol Encapsulation over ATM Adaptation Layer 5
RFC 2766	Network Address Translation - Protocol
IEEE 802.11	Also known by the brand Wi-Fi, denotes a set of Wireless LAN/WLAN standards developed by working group 11 of the IEEE LAN/MAN Standards Committee (IEEE 802)
IEEE 802.11b	Uses the 2.4 gigahertz (GHz) band
IEEE 802.11g	Uses the 2.4 gigahertz (GHz) band
IEEE 802.11n	Uses the 2.4 gigahertz (GHz) band and 5 gigahertz (GHz) band

Table 87 Standards Supported (continued)

STANDARD	DESCRIPTION
IEEE 802.11d	Standard for Local and Metropolitan Area Networks: Media Access Control (MAC) Bridges
802.1x	Port Based Network Access Control
IEEE 802.11e QoS	IEEE 802.11 e Wireless LAN for Quality of Service
ANSI T1.413, Issue 2	Asymmetric Digital Subscriber Line (ADSL) standard
G dmt(G.992.1)	G.992.1 Asymmetrical Digital Subscriber Line (ADSL) Transceivers
ITU G.992.1 (G.DMT)	ITU standard for ADSL using discrete multitone modulation
ITU G.992.2 (G. Lite)	ITU standard for ADSL using discrete multitone modulation
ITU G.992.3 (G.dmt.bis)	ITU standard (also referred to as ADSL2) that extends the capability of basic ADSL in data rates
ITU G.992.4 (G.lite.bis)	ITU standard (also referred to as ADSL2) that extends the capability of basic ADSL in data rates
ITU G.992.5 (ADSL2+)	ITU standard (also referred to as ADSL2+) that extends the capability of basic ADSL by doubling the number of downstream bits
RFC 2383	ST2+ over ATM Protocol Specification - UNI 3.1 Version
TR-069	TR-069 DSL Forum Standard for CPE Wan Management
TR-064	DSL Forum LAN-Side DSL CPE Configuration
1.363.5	Compliant AAL5 SAR (Segmentation And Re-assembly)

Wall-mounting Instructions

Do the following to hang your ZyXEL Device on a wall.

Note: See [Table 83 on page 301](#) for the size of screws to use and how far apart to place them.

- 1 Locate a high position on a wall that is free of obstructions. Use a sturdy wall.
- 2 Drill two holes for the screws. Make sure the distance between the centers of the holes matches what is listed in the product specifications appendix.

Be careful to avoid damaging pipes or cables located inside the wall when drilling holes for the screws.

- 3 Do not screw the screws all the way into the wall. Leave a small gap of about 0.5 cm between the heads of the screws and the wall.
- 4 Make sure the screws are snugly fastened to the wall. They need to hold the weight of the ZyXEL Device with the connection cables.

- 5 Align the holes on the back of the ZyXEL Device with the screws on the wall. Hang the ZyXEL Device on the screws.

Figure 130 Wall-mounting Example

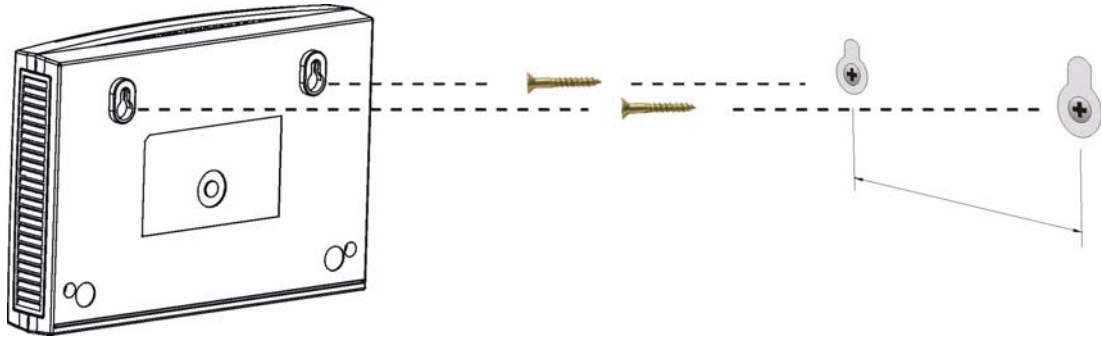

The following are dimensions of an M4 tap screw and masonry plug used for wall mounting. All measurements are in millimeters (mm).

Figure 131 Masonry Plug and M4 Tap Screw

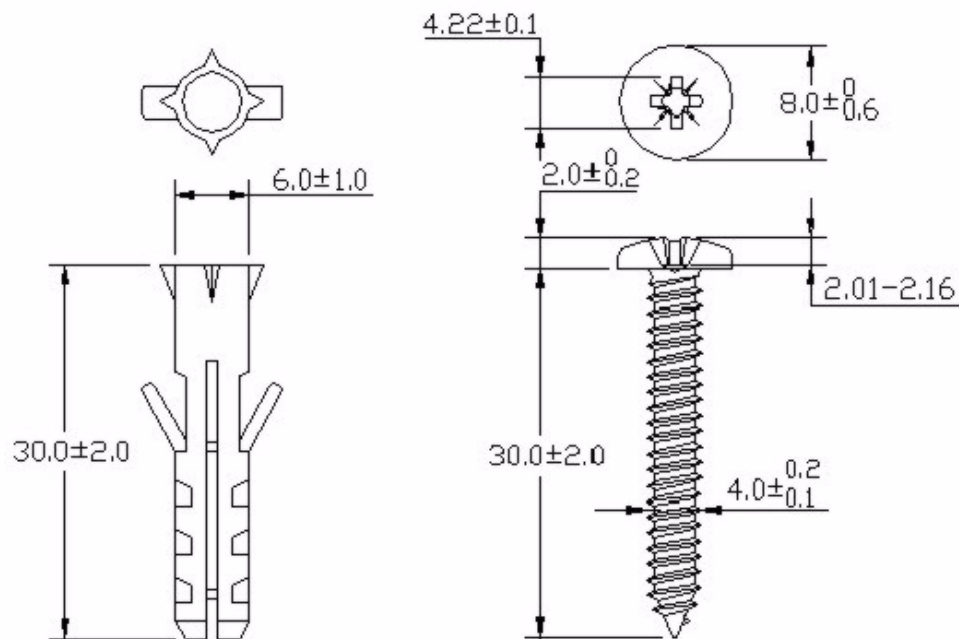

IP Addresses and Subnetting

This appendix introduces IP addresses and subnet masks.

IP addresses identify individual devices on a network. Every networking device (such as computers, servers, routers, and printers) needs an IP address to communicate across the network. These networking devices are also known as hosts.

Subnet masks determine the maximum number of possible hosts on a network. You can also use subnet masks to divide one network into multiple sub-networks.

Introduction to IP Addresses

One part of the IP address is the network number, and the other part is the host ID. In the same way that houses on a street share a common street name, the hosts on a network share a common network number. Similarly, as each house has its own house number, each host on the network has its own unique identifying number - the host ID. Routers use the network number to send packets to the correct network, while the host ID determines to which host on the network the packets are delivered.

Structure

An IP address is made up of four parts, written in dotted decimal notation (for example, 192.168.1.1). Each of these four parts is known as an octet. An octet is an eight-digit binary number (for example 11000000, which is 192 in decimal notation).

Therefore, each octet has a possible range of 00000000 to 11111111 in binary, or 0 to 255 in decimal.

The following figure shows an example IP address in which the first three octets (192.168.1) are the network number, and the fourth octet (16) is the host ID.

Figure 132 Network Number and Host ID

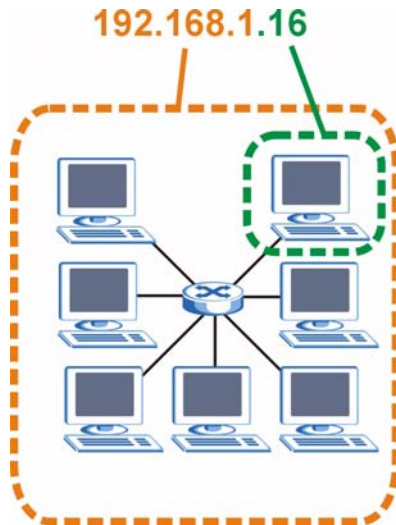

How much of the IP address is the network number and how much is the host ID varies according to the subnet mask.

Subnet Masks

A subnet mask is used to determine which bits are part of the network number, and which bits are part of the host ID (using a logical AND operation). The term “subnet” is short for “sub-network”.

A subnet mask has 32 bits. If a bit in the subnet mask is a “1” then the corresponding bit in the IP address is part of the network number. If a bit in the subnet mask is “0” then the corresponding bit in the IP address is part of the host ID.

The following example shows a subnet mask identifying the network number (in bold text) and host ID of an IP address (192.168.1.2 in decimal).

Table 88 IP Address Network Number and Host ID Example

	1ST OCTET: (192)	2ND OCTET: (168)	3RD OCTET: (1)	4TH OCTET (2)
IP Address (Binary)	11000000	10101000	00000001	00000010
Subnet Mask (Binary)	11111111	11111111	11111111	00000000
Network Number	11000000	10101000	00000001	
Host ID				00000010

By convention, subnet masks always consist of a continuous sequence of ones beginning from the leftmost bit of the mask, followed by a continuous sequence of zeros, for a total number of 32 bits.

Subnet masks can be referred to by the size of the network number part (the bits with a "1" value). For example, an "8-bit mask" means that the first 8 bits of the mask are ones and the remaining 24 bits are zeroes.

Subnet masks are expressed in dotted decimal notation just like IP addresses. The following examples show the binary and decimal notation for 8-bit, 16-bit, 24-bit and 29-bit subnet masks.

Table 89 Subnet Masks

	BINARY				DECIMAL
	1ST OCTET	2ND OCTET	3RD OCTET	4TH OCTET	
8-bit mask	11111111	00000000	00000000	00000000	255.0.0.0
16-bit mask	11111111	11111111	00000000	00000000	255.255.0.0
24-bit mask	11111111	11111111	11111111	00000000	255.255.255.0
29-bit mask	11111111	11111111	11111111	11111000	255.255.255.248

Network Size

The size of the network number determines the maximum number of possible hosts you can have on your network. The larger the number of network number bits, the smaller the number of remaining host ID bits.

An IP address with host IDs of all zeros is the IP address of the network (192.168.1.0 with a 24-bit subnet mask, for example). An IP address with host IDs of all ones is the broadcast address for that network (192.168.1.255 with a 24-bit subnet mask, for example).

As these two IP addresses cannot be used for individual hosts, calculate the maximum number of possible hosts in a network as follows:

Table 90 Maximum Host Numbers

SUBNET MASK		HOST ID SIZE		MAXIMUM NUMBER OF HOSTS
8 bits	255.0.0.0	24 bits	$2^{24} - 2$	16777214
16 bits	255.255.0.0	16 bits	$2^{16} - 2$	65534
24 bits	255.255.255.0	8 bits	$2^8 - 2$	254
29 bits	255.255.255.248	3 bits	$2^3 - 2$	6

Notation

Since the mask is always a continuous number of ones beginning from the left, followed by a continuous number of zeros for the remainder of the 32 bit mask, you can simply specify the number of ones instead of writing the value of each octet. This is usually specified by writing a "/" followed by the number of bits in the mask after the address.

For example, 192.1.1.0 /25 is equivalent to saying 192.1.1.0 with subnet mask 255.255.255.128.

The following table shows some possible subnet masks using both notations.

Table 91 Alternative Subnet Mask Notation

SUBNET MASK	ALTERNATIVE NOTATION	LAST OCTET (BINARY)	LAST OCTET (DECIMAL)
255.255.255.0	/24	0000 0000	0
255.255.255.128	/25	1000 0000	128
255.255.255.192	/26	1100 0000	192
255.255.255.224	/27	1110 0000	224
255.255.255.240	/28	1111 0000	240
255.255.255.248	/29	1111 1000	248
255.255.255.252	/30	1111 1100	252

Subnetting

You can use subnetting to divide one network into multiple sub-networks. In the following example a network administrator creates two sub-networks to isolate a group of servers from the rest of the company network for security reasons.

In this example, the company network address is 192.168.1.0. The first three octets of the address (192.168.1) are the network number, and the remaining octet is the host ID, allowing a maximum of $2^8 - 2$ or 254 possible hosts.

The following figure shows the company network before subnetting.

Figure 133 Subnetting Example: Before Subnetting

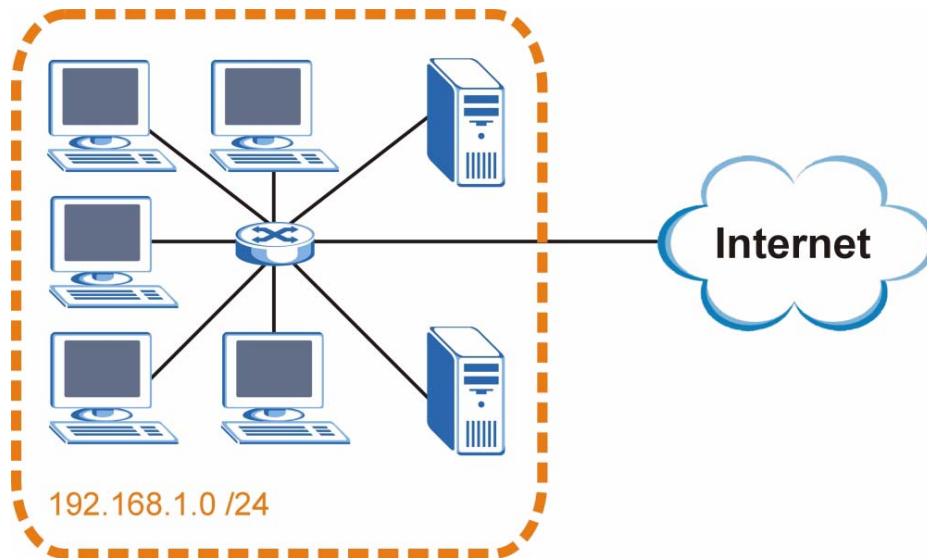

You can “borrow” one of the host ID bits to divide the network 192.168.1.0 into two separate sub-networks. The subnet mask is now 25 bits (255.255.255.128 or /25).

The “borrowed” host ID bit can have a value of either 0 or 1, allowing two subnets; 192.168.1.0 /25 and 192.168.1.128 /25.

The following figure shows the company network after subnetting. There are now two sub-networks, **A** and **B**.

Figure 134 Subnetting Example: After Subnetting

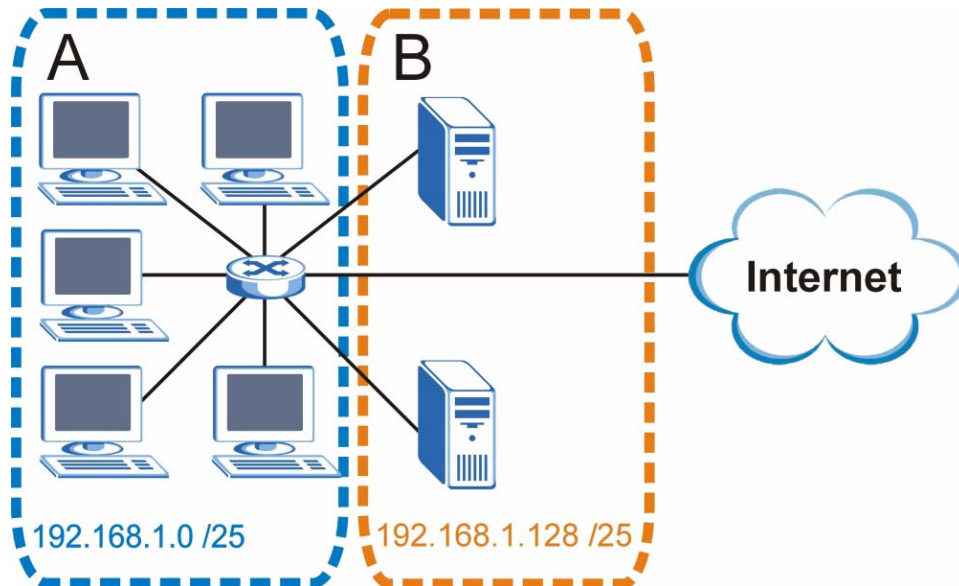

In a 25-bit subnet the host ID has 7 bits, so each sub-network has a maximum of $2^7 - 2$ or 126 possible hosts (a host ID of all zeroes is the subnet's address itself, all ones is the subnet's broadcast address).

192.168.1.0 with mask 255.255.255.128 is subnet **A** itself, and 192.168.1.127 with mask 255.255.255.128 is its broadcast address. Therefore, the lowest IP address that can be assigned to an actual host for subnet **A** is 192.168.1.1 and the highest is 192.168.1.126.

Similarly, the host ID range for subnet **B** is 192.168.1.129 to 192.168.1.254.

Example: Four Subnets

The previous example illustrated using a 25-bit subnet mask to divide a 24-bit address into two subnets. Similarly, to divide a 24-bit address into four subnets, you need to "borrow" two host ID bits to give four possible combinations (00, 01, 10 and 11). The subnet mask is 26 bits (11111111.11111111.11111111.11000000) or 255.255.255.192.

Each subnet contains 6 host ID bits, giving $2^6 - 2$ or 62 hosts for each subnet (a host ID of all zeroes is the subnet itself, all ones is the subnet's broadcast address).

Table 92 Subnet 1

IP/SUBNET MASK	NETWORK NUMBER	LAST OCTET BIT VALUE
IP Address (Decimal)	192.168.1.	0
IP Address (Binary)	11000000.10101000.00000001.	00000000
Subnet Mask (Binary)	11111111.11111111.11111111.	11000000
Subnet Address: 192.168.1.0	Lowest Host ID: 192.168.1.1	
Broadcast Address: 192.168.1.63	Highest Host ID: 192.168.1.62	

Table 93 Subnet 2

IP/SUBNET MASK	NETWORK NUMBER	LAST OCTET BIT VALUE
IP Address	192.168.1.	64
IP Address (Binary)	11000000.10101000.00000001.	01000000
Subnet Mask (Binary)	11111111.11111111.11111111.	11000000
Subnet Address: 192.168.1.64	Lowest Host ID: 192.168.1.65	
Broadcast Address: 192.168.1.127	Highest Host ID: 192.168.1.126	

Table 94 Subnet 3

IP/SUBNET MASK	NETWORK NUMBER	LAST OCTET BIT VALUE
IP Address	192.168.1.	128
IP Address (Binary)	11000000.10101000.00000001.	10000000
Subnet Mask (Binary)	11111111.11111111.11111111.	11000000
Subnet Address: 192.168.1.128	Lowest Host ID: 192.168.1.129	
Broadcast Address: 192.168.1.191	Highest Host ID: 192.168.1.190	

Table 95 Subnet 4

IP/SUBNET MASK	NETWORK NUMBER	LAST OCTET BIT VALUE
IP Address	192.168.1.	192
IP Address (Binary)	11000000.10101000.00000001.	11000000
Subnet Mask (Binary)	11111111.11111111.11111111.	11000000
Subnet Address: 192.168.1.192	Lowest Host ID: 192.168.1.193	
Broadcast Address: 192.168.1.255	Highest Host ID: 192.168.1.254	

Example: Eight Subnets

Similarly, use a 27-bit mask to create eight subnets (000, 001, 010, 011, 100, 101, 110 and 111).

The following table shows IP address last octet values for each subnet.

Table 96 Eight Subnets

SUBNET	SUBNET ADDRESS	FIRST ADDRESS	LAST ADDRESS	BROADCAST ADDRESS
1	0	1	30	31
2	32	33	62	63
3	64	65	94	95
4	96	97	126	127
5	128	129	158	159
6	160	161	190	191
7	192	193	222	223
8	224	225	254	255

Subnet Planning

The following table is a summary for subnet planning on a network with a 24-bit network number.

Table 97 24-bit Network Number Subnet Planning

NO. "BORROWED" HOST BITS	SUBNET MASK	NO. SUBNETS	NO. HOSTS PER SUBNET
1	255.255.255.128 (/25)	2	126
2	255.255.255.192 (/26)	4	62
3	255.255.255.224 (/27)	8	30
4	255.255.255.240 (/28)	16	14
5	255.255.255.248 (/29)	32	6
6	255.255.255.252 (/30)	64	2
7	255.255.255.254 (/31)	128	1

The following table is a summary for subnet planning on a network with a 16-bit network number.

Table 98 16-bit Network Number Subnet Planning

NO. "BORROWED" HOST BITS	SUBNET MASK	NO. SUBNETS	NO. HOSTS PER SUBNET
1	255.255.128.0 (/17)	2	32766
2	255.255.192.0 (/18)	4	16382

Table 98 16-bit Network Number Subnet Planning (continued)

NO. "BORROWED" HOST BITS	SUBNET MASK	NO. SUBNETS	NO. HOSTS PER SUBNET
3	255.255.224.0 (/19)	8	8190
4	255.255.240.0 (/20)	16	4094
5	255.255.248.0 (/21)	32	2046
6	255.255.252.0 (/22)	64	1022
7	255.255.254.0 (/23)	128	510
8	255.255.255.0 (/24)	256	254
9	255.255.255.128 (/25)	512	126
10	255.255.255.192 (/26)	1024	62
11	255.255.255.224 (/27)	2048	30
12	255.255.255.240 (/28)	4096	14
13	255.255.255.248 (/29)	8192	6
14	255.255.255.252 (/30)	16384	2
15	255.255.255.254 (/31)	32768	1

Configuring IP Addresses

Where you obtain your network number depends on your particular situation. If the ISP or your network administrator assigns you a block of registered IP addresses, follow their instructions in selecting the IP addresses and the subnet mask.

If the ISP did not explicitly give you an IP network number, then most likely you have a single user account and the ISP will assign you a dynamic IP address when the connection is established. If this is the case, it is recommended that you select a network number from 192.168.0.0 to 192.168.255.0. The Internet Assigned Number Authority (IANA) reserved this block of addresses specifically for private use; please do not use any other number unless you are told otherwise. You must also enable Network Address Translation (NAT) on the ZyXEL Device.

Once you have decided on the network number, pick an IP address for your ZyXEL Device that is easy to remember (for instance, 192.168.1.1) but make sure that no other device on your network is using that IP address.

The subnet mask specifies the network number portion of an IP address. Your ZyXEL Device will compute the subnet mask automatically based on the IP address that you entered. You don't need to change the subnet mask computed by the ZyXEL Device unless you are instructed to do otherwise.

Private IP Addresses

Every machine on the Internet must have a unique address. If your networks are isolated from the Internet (running only between two branch offices, for example) you can assign any IP addresses to the hosts without problems. However, the Internet Assigned Numbers Authority (IANA) has reserved the following three blocks of IP addresses specifically for private networks:

- 10.0.0.0 — 10.255.255.255
- 172.16.0.0 — 172.31.255.255
- 192.168.0.0 — 192.168.255.255

You can obtain your IP address from the IANA, from an ISP, or it can be assigned from a private network. If you belong to a small organization and your Internet access is through an ISP, the ISP can provide you with the Internet addresses for your local networks. On the other hand, if you are part of a much larger organization, you should consult your network administrator for the appropriate IP addresses.

Regardless of your particular situation, do not create an arbitrary IP address; always follow the guidelines above. For more information on address assignment, please refer to RFC 1597, *Address Allocation for Private Internets* and RFC 1466, *Guidelines for Management of IP Address Space*.

IP Address Conflicts

Each device on a network must have a unique IP address. Devices with duplicate IP addresses on the same network will not be able to access the Internet or other resources. The devices may also be unreachable through the network.

Conflicting Computer IP Addresses Example

More than one device can not use the same IP address. In the following example computer **A** has a static (or fixed) IP address that is the same as the IP address that a DHCP server assigns to computer **B** which is a DHCP client. Neither can access the Internet. This problem can be solved by assigning a different static IP

address to computer **A** or setting computer **A** to obtain an IP address automatically.

Figure 135 Conflicting Computer IP Addresses Example

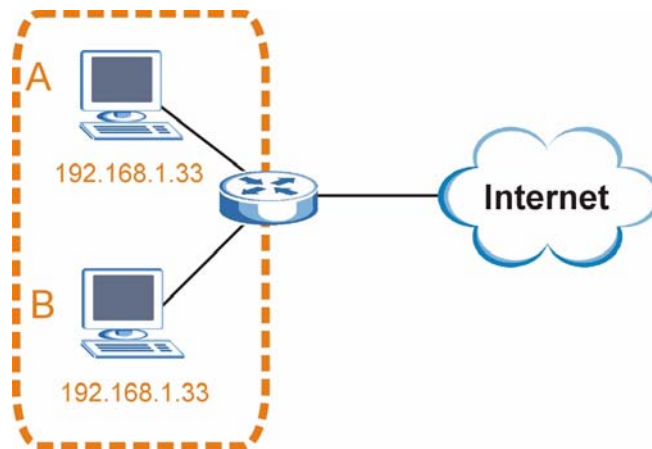

Conflicting Router IP Addresses Example

Since a router connects different networks, it must have interfaces using different network numbers. For example, if a router is set between a LAN and the Internet (WAN), the router's LAN and WAN addresses must be on different subnets. In the following example, the LAN and WAN are on the same subnet. The LAN computers cannot access the Internet because the router cannot route between networks.

Figure 136 Conflicting Computer IP Addresses Example

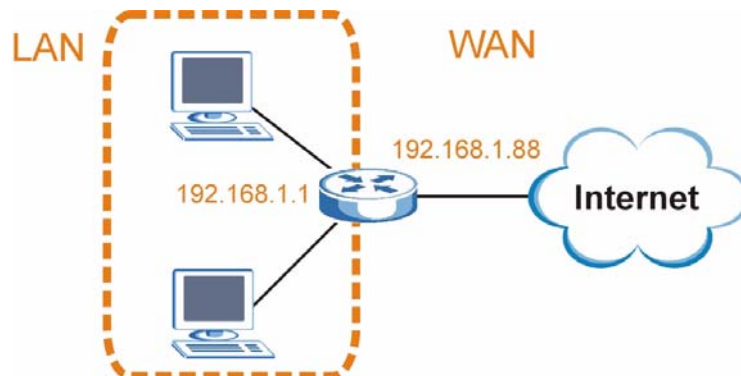

Conflicting Computer and Router IP Addresses Example

More than one device can not use the same IP address. In the following example, the computer and the router's LAN port both use 192.168.1.1 as the IP address.

The computer cannot access the Internet. This problem can be solved by assigning a different IP address to the computer or the router's LAN port.

Figure 137 Conflicting Computer and Router IP Addresses Example

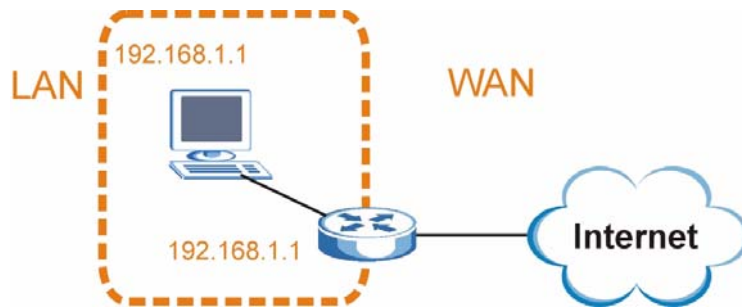

Setting Up Your Computer's IP Address

Note: Your specific ZyXEL Device may not support all of the operating systems described in this appendix. See the product specifications for more information about which operating systems are supported.

This appendix shows you how to configure the IP settings on your computer in order for it to be able to communicate with the other devices on your network. Windows Vista/XP/2000, Mac OS 9/OS X, and all versions of UNIX/LINUX include the software components you need to use TCP/IP on your computer.

If you manually assign IP information instead of using a dynamic IP, make sure that your network's computers have IP addresses that place them in the same subnet.

In this appendix, you can set up an IP address for:

- [Windows XP/NT/2000](#) on [page 323](#)
- [Windows Vista](#) on [page 327](#)
- [Windows 7](#) on [page 331](#)
- [Mac OS X: 10.3 and 10.4](#) on [page 335](#)
- [Mac OS X: 10.5](#) on [page 339](#)
- [Linux: Ubuntu 8 \(GNOME\)](#) on [page 342](#)
- [Linux: openSUSE 10.3 \(KDE\)](#) on [page 347](#)

Windows XP/NT/2000

The following example uses the default Windows XP display theme but can also apply to Windows 2000 and Windows NT.

- 1 Click **Start > Control Panel**.

Figure 138 Windows XP: Start Menu

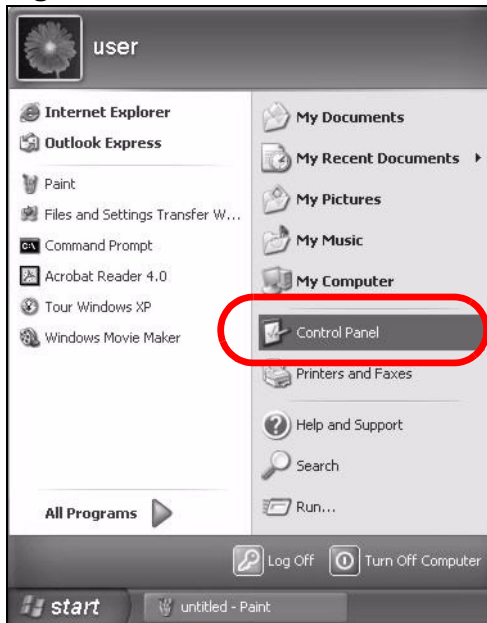

- 2 In the **Control Panel**, click the **Network Connections** icon.

Figure 139 Windows XP: Control Panel

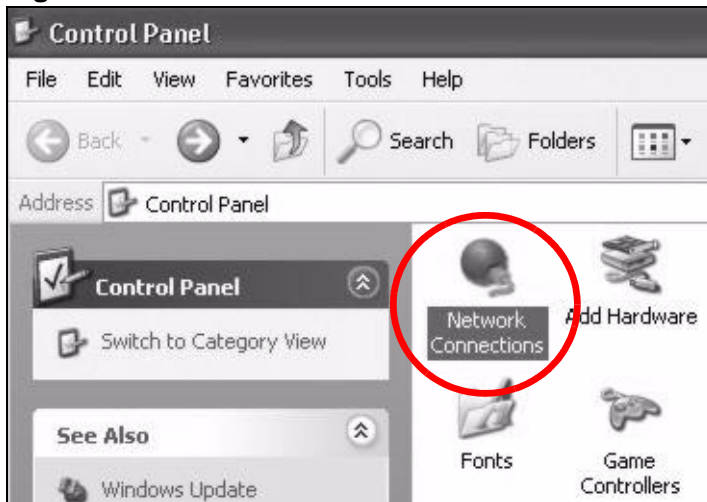

- 3 Right-click **Local Area Connection** and then select **Properties**.

Figure 140 Windows XP: Control Panel > Network Connections > Properties

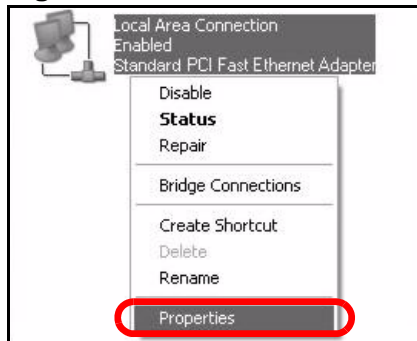

- 4 On the **General** tab, select **Internet Protocol (TCP/IP)** and then click **Properties**.

Figure 141 Windows XP: Local Area Connection Properties

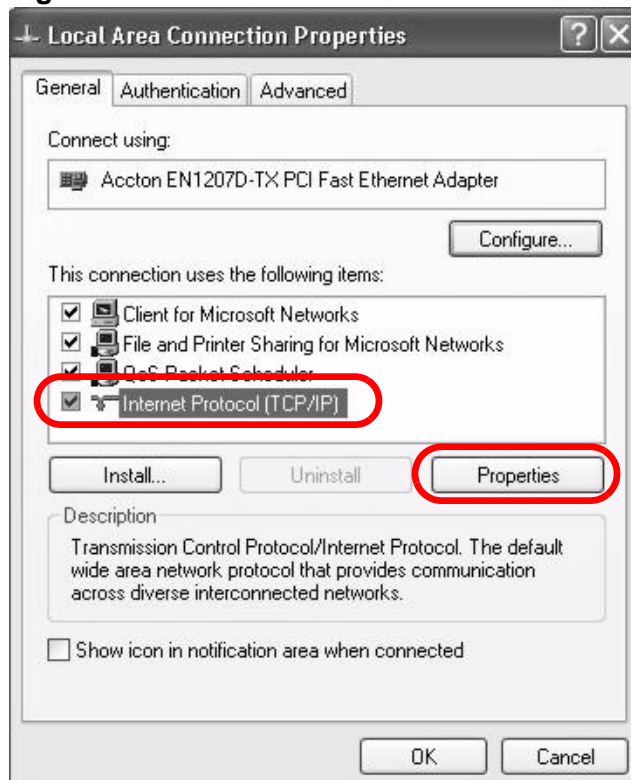

- 5 The **Internet Protocol TCP/IP Properties** window opens.

Figure 142 Windows XP: Internet Protocol (TCP/IP) Properties

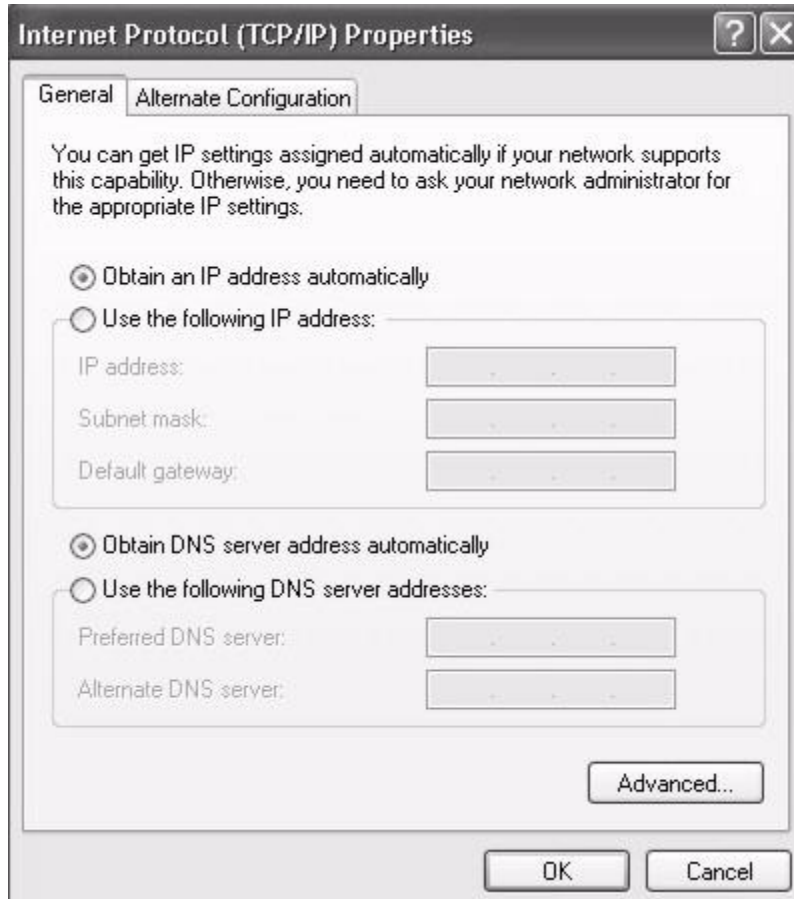

- 6 Select **Obtain an IP address automatically** if your network administrator or ISP assigns your IP address dynamically.

Select **Use the following IP Address** and fill in the **IP address**, **Subnet mask**, and **Default gateway** fields if you have a static IP address that was assigned to you by your network administrator or ISP. You may also have to enter a **Preferred DNS server** and an **Alternate DNS server**, if that information was provided.

- 7 Click **OK** to close the **Internet Protocol (TCP/IP) Properties** window.
- 8 Click **OK** to close the **Local Area Connection Properties** window.

Verifying Settings

- 1 Click **Start > All Programs > Accessories > Command Prompt**.

- 2 In the **Command Prompt** window, type "ipconfig" and then press [ENTER].

You can also go to **Start > Control Panel > Network Connections**, right-click a network connection, click **Status** and then click the **Support** tab to view your IP address and connection information.

Windows Vista

This section shows screens from Windows Vista Professional.

- 1 Click **Start > Control Panel**.

Figure 143 Windows Vista: Start Menu

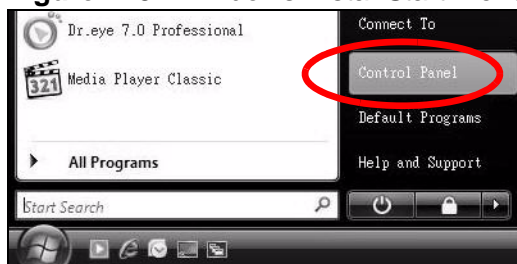

- 2 In the **Control Panel**, click the **Network and Internet** icon.

Figure 144 Windows Vista: Control Panel

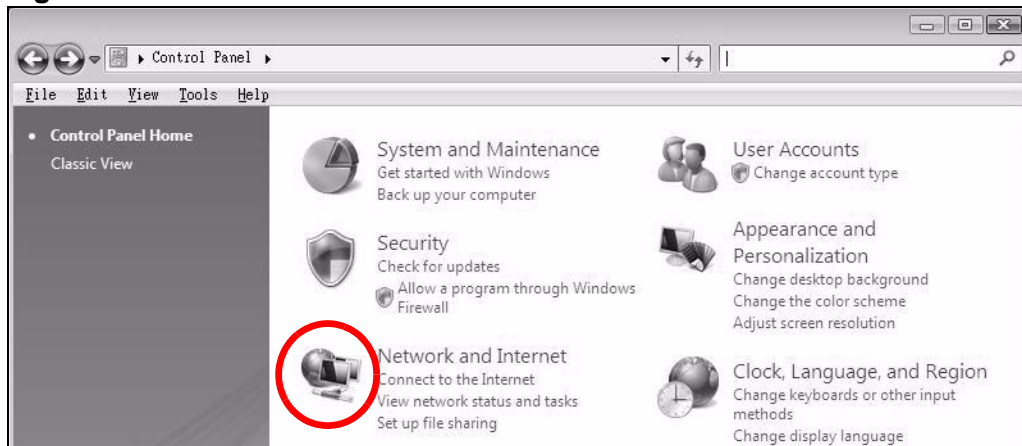

- 3 Click the **Network and Sharing Center** icon.

Figure 145 Windows Vista: Network And Internet

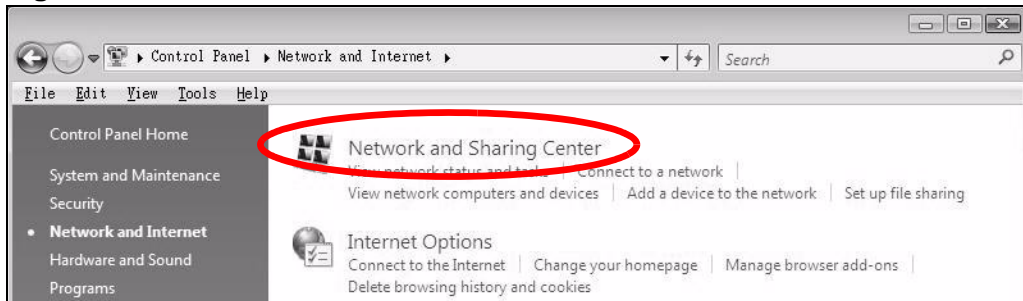

- 4 Click **Manage network connections**.

Figure 146 Windows Vista: Network and Sharing Center

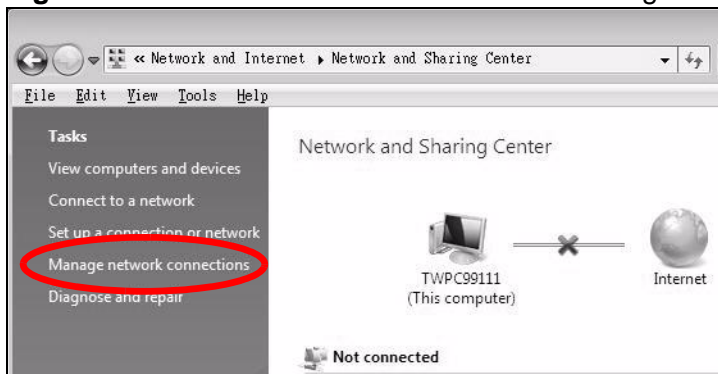

- 5 Right-click **Local Area Connection** and then select **Properties**.

Figure 147 Windows Vista: Network and Sharing Center

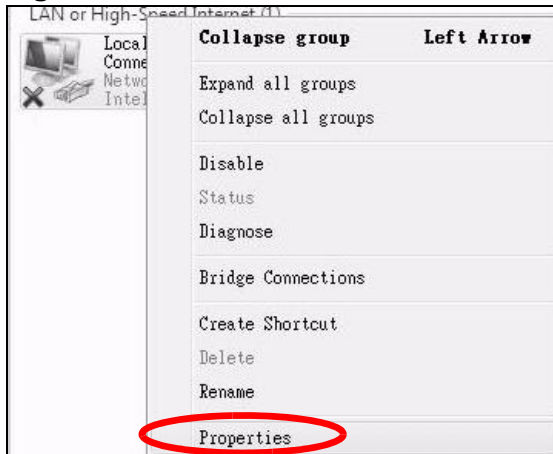

Note: During this procedure, click **Continue** whenever Windows displays a screen saying that it needs your permission to continue.

- 6 Select **Internet Protocol Version 4 (TCP/IPv4)** and then select **Properties**.

Figure 148 Windows Vista: Local Area Connection Properties

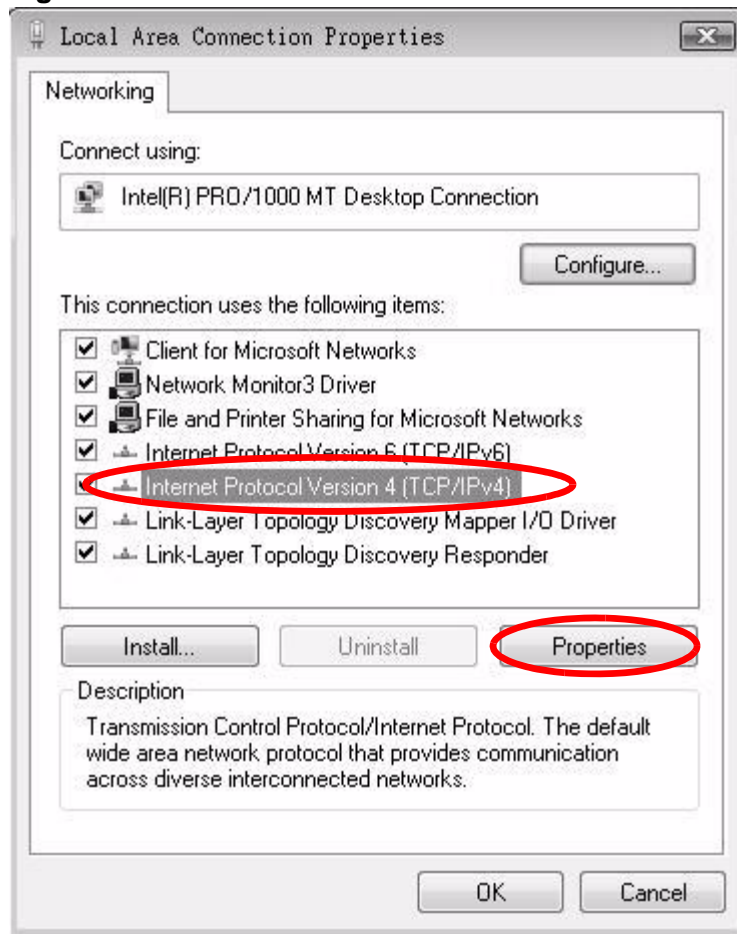

- 7 The **Internet Protocol Version 4 (TCP/IPv4) Properties** window opens.

Figure 149 Windows Vista: Internet Protocol Version 4 (TCP/IPv4) Properties

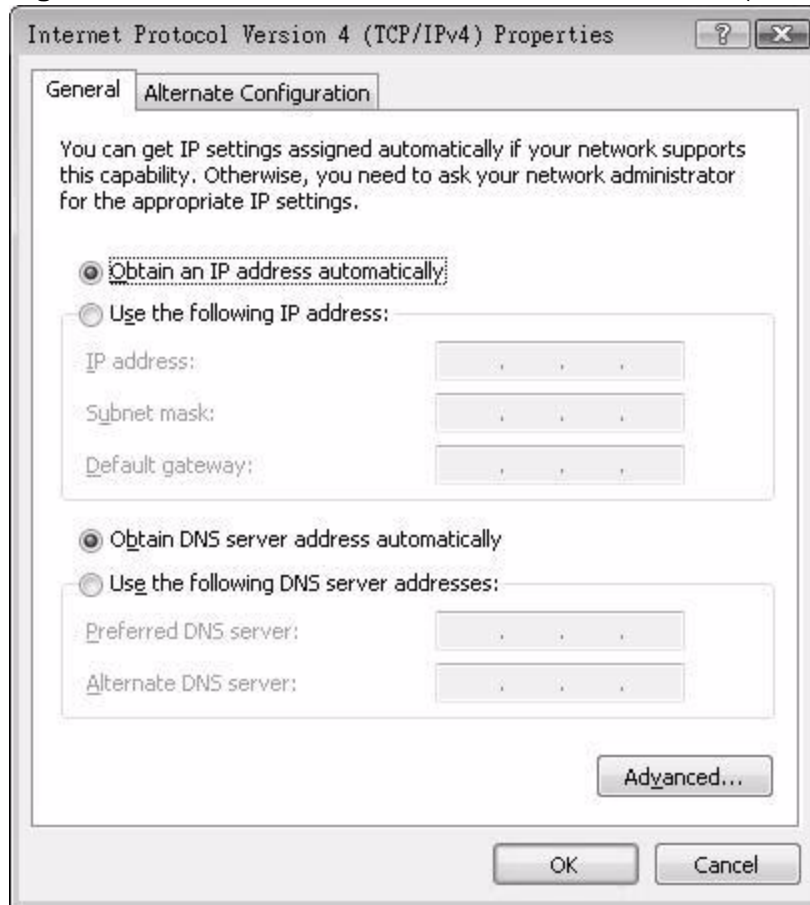

- 8 Select **Obtain an IP address automatically** if your network administrator or ISP assigns your IP address dynamically.

Select **Use the following IP Address** and fill in the **IP address**, **Subnet mask**, and **Default gateway** fields if you have a static IP address that was assigned to you by your network administrator or ISP. You may also have to enter a **Preferred DNS server** and an **Alternate DNS server**, if that information was provided. Click **Advanced**.

- 9 Click **OK** to close the **Internet Protocol (TCP/IP) Properties** window.
- 10 Click **OK** to close the **Local Area Connection Properties** window.

Verifying Settings

- 1 Click **Start > All Programs > Accessories > Command Prompt**.

- 2 In the **Command Prompt** window, type "ipconfig" and then press [ENTER].

You can also go to **Start > Control Panel > Network Connections**, right-click a network connection, click **Status** and then click the **Support** tab to view your IP address and connection information.

Windows 7

This section shows screens from Windows 7 Enterprise.

- 1 Click **Start > Control Panel**.

Figure 150 Windows 7: Start Menu

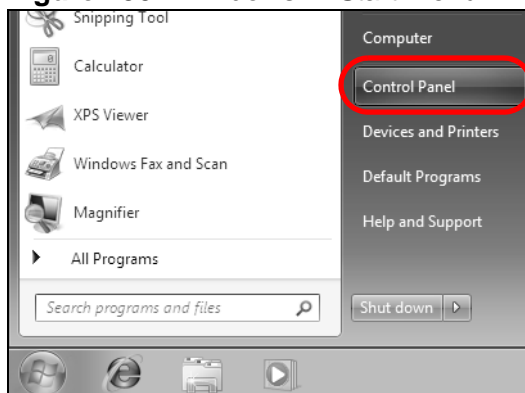

- 2 In the **Control Panel**, click **View network status and tasks** under the **Network and Internet** category.

Figure 151 Windows 7: Control Panel

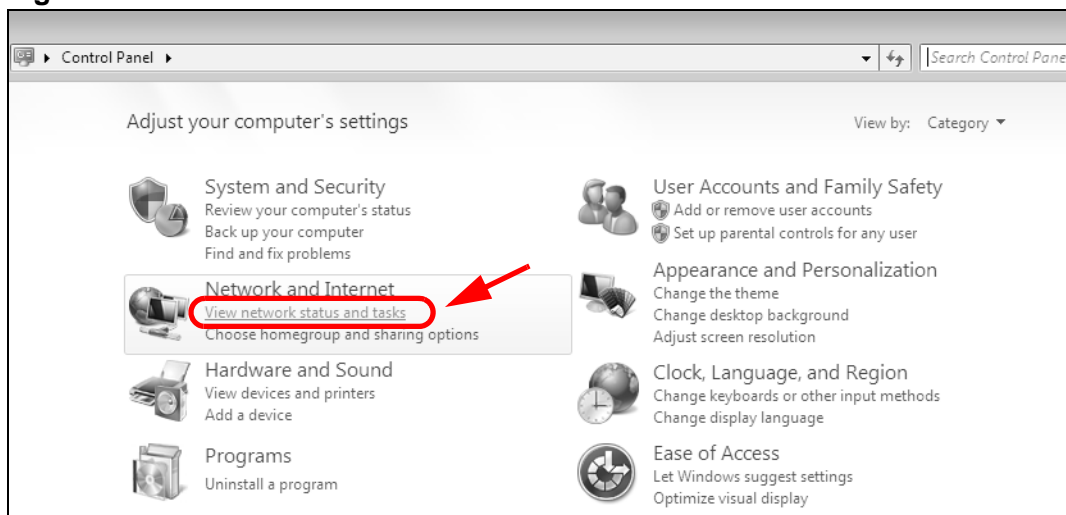

3 Click **Change adapter settings**.

Figure 152 Windows 7: Network And Sharing Center

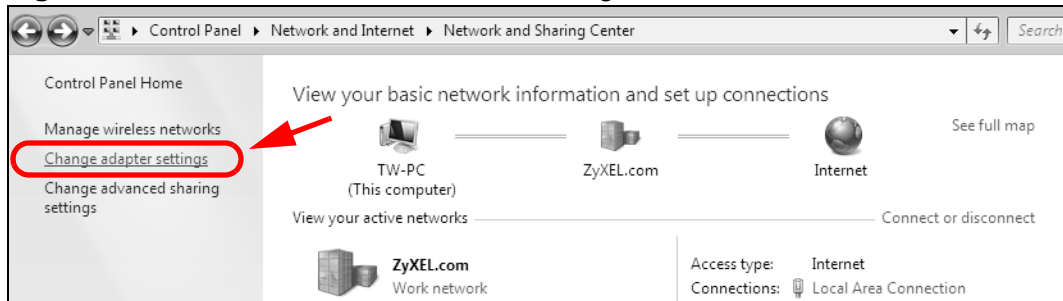

4 Double click **Local Area Connection** and then select **Properties**.

Figure 153 Windows 7: Local Area Connection Status

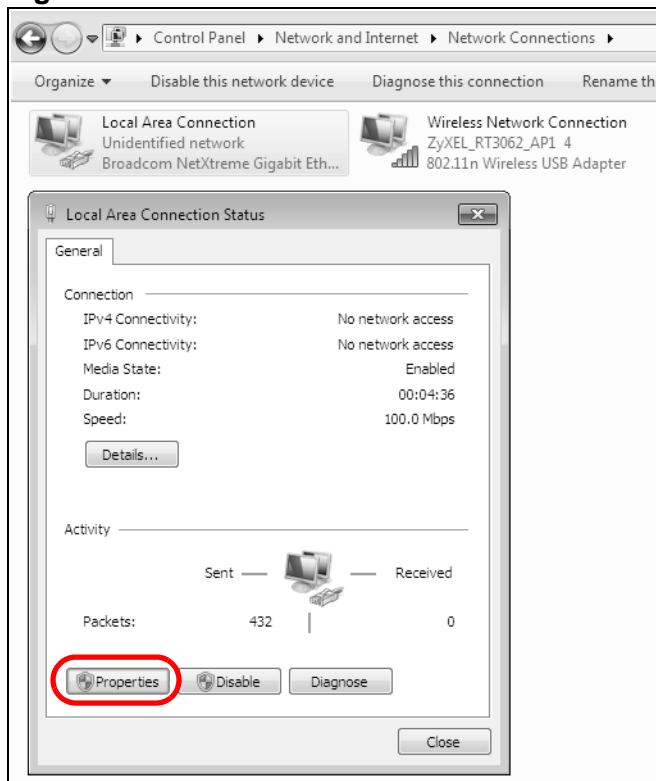

Note: During this procedure, click **Continue** whenever Windows displays a screen saying that it needs your permission to continue.

- 5 Select **Internet Protocol Version 4 (TCP/IPv4)** and then select **Properties**.

Figure 154 Windows 7: Local Area Connection Properties

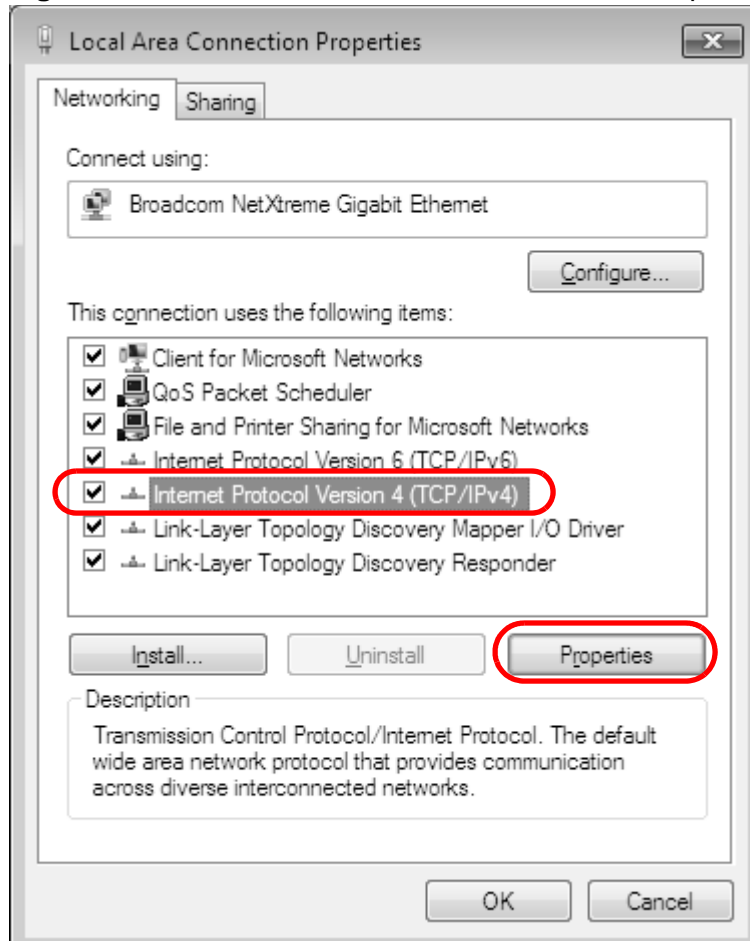

- The **Internet Protocol Version 4 (TCP/IPv4) Properties** window opens.

Figure 155 Windows 7: Internet Protocol Version 4 (TCP/IPv4) Properties

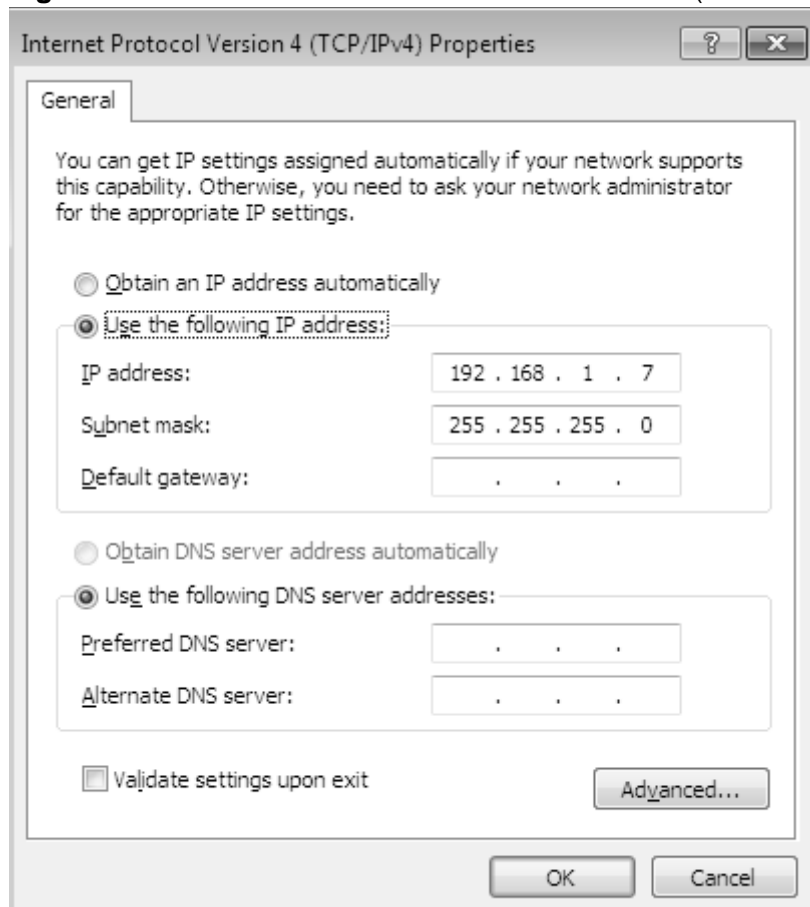

- Select **Obtain an IP address automatically** if your network administrator or ISP assigns your IP address dynamically.

Select **Use the following IP Address** and fill in the **IP address**, **Subnet mask**, and **Default gateway** fields if you have a static IP address that was assigned to you by your network administrator or ISP. You may also have to enter a **Preferred DNS server** and an **Alternate DNS server**, if that information was provided. Click **Advanced** if you want to configure advanced settings for IP, DNS and WINS.

- Click **OK** to close the **Internet Protocol (TCP/IP) Properties** window.
- Click **OK** to close the **Local Area Connection Properties** window.

Verifying Settings

- Click **Start > All Programs > Accessories > Command Prompt**.
- In the **Command Prompt** window, type "ipconfig" and then press [ENTER].

- 3 The IP settings are displayed as follows.

Figure 156 Windows 7: Internet Protocol Version 4 (TCP/IPv4) Properties

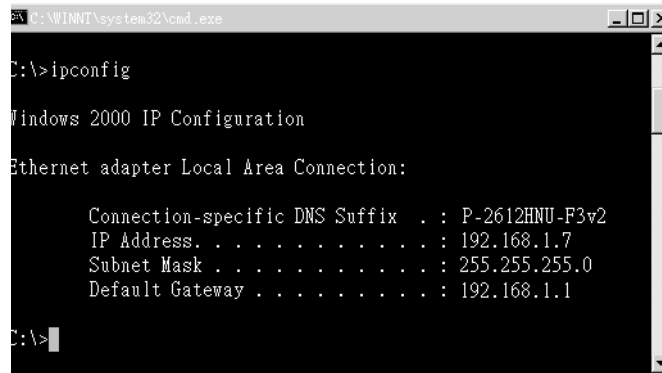

```
C:\WINNT\system32\cmd.exe
C:\>ipconfig

Windows 2000 IP Configuration

Ethernet adapter Local Area Connection:

    Connection-specific DNS Suffix . : P-2612HNU-F3v2
    IP Address . . . . . : 192.168.1.7
    Subnet Mask . . . . . : 255.255.255.0
    Default Gateway . . . . . : 192.168.1.1

C:\>
```

Mac OS X: 10.3 and 10.4

The screens in this section are from Mac OS X 10.4 but can also apply to 10.3.

- 1 Click **Apple > System Preferences**.

Figure 157 Mac OS X 10.4: Apple Menu



- 2 In the **System Preferences** window, click the **Network** icon.

Figure 158 Mac OS X 10.4: System Preferences



- 3 When the **Network** preferences pane opens, select **Built-in Ethernet** from the network connection type list, and then click **Configure**.

Figure 159 Mac OS X 10.4: Network Preferences

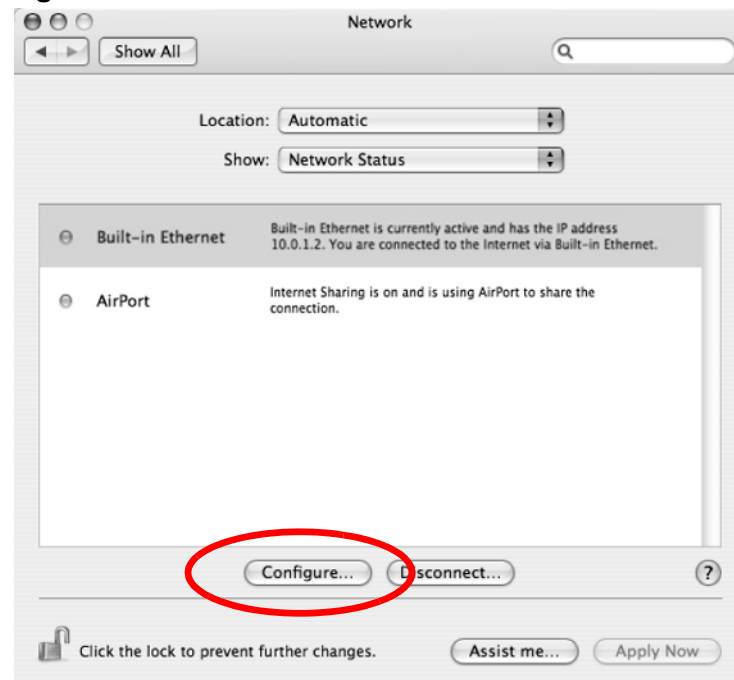

- 4 For dynamically assigned settings, select **Using DHCP** from the **Configure IPv4** list in the **TCP/IP** tab.

Figure 160 Mac OS X 10.4: Network Preferences > TCP/IP Tab.

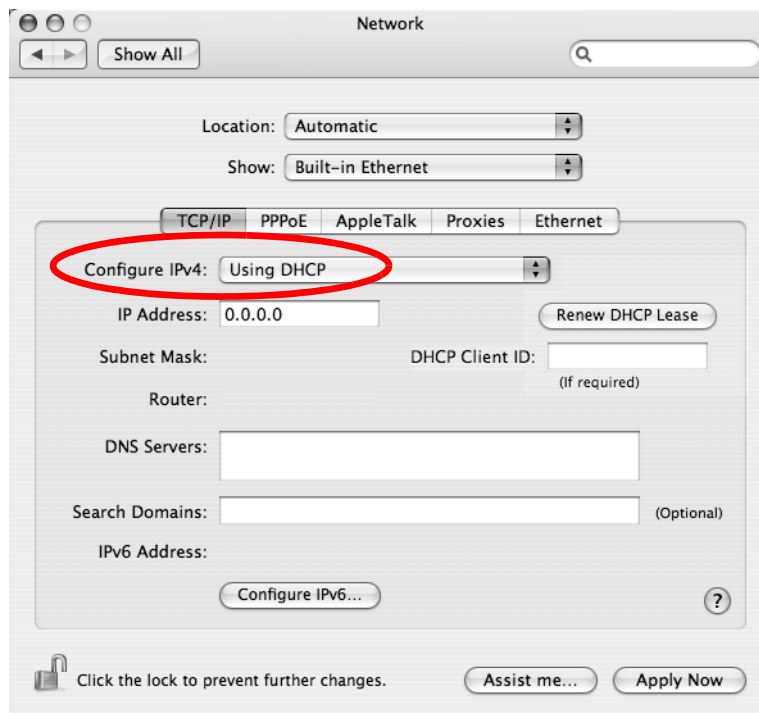

- 5 For statically assigned settings, do the following:
 - From the **Configure IPv4** list, select **Manually**.
 - In the **IP Address** field, type your IP address.
 - In the **Subnet Mask** field, type your subnet mask.

- In the **Router** field, type the IP address of your device.

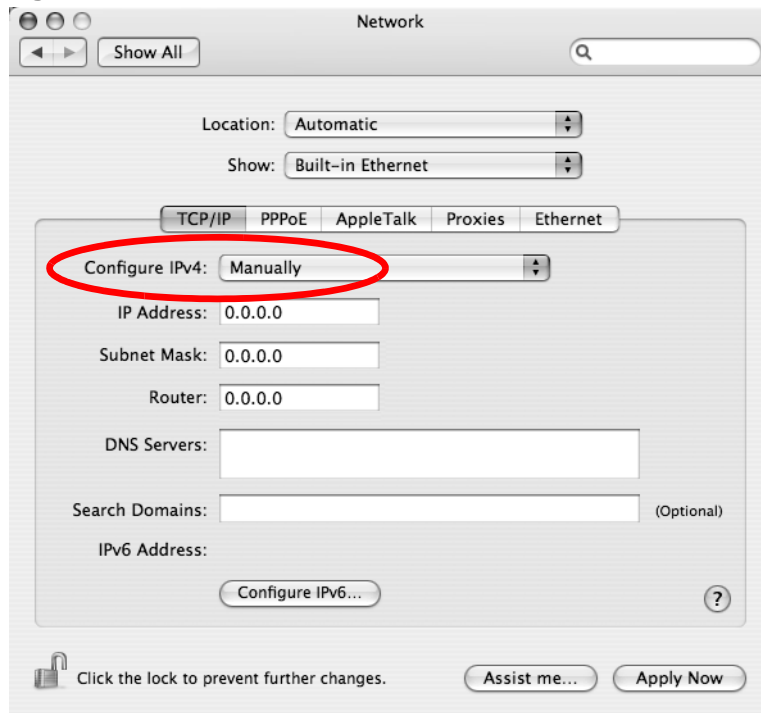
Figure 161 Mac OS X 10.4: Network Preferences > Ethernet

- 6 Click **Apply Now** and close the window.

Verifying Settings

Check your TCP/IP properties by clicking **Applications > Utilities > Network Utilities**, and then selecting the appropriate **Network Interface** from the **Info** tab.

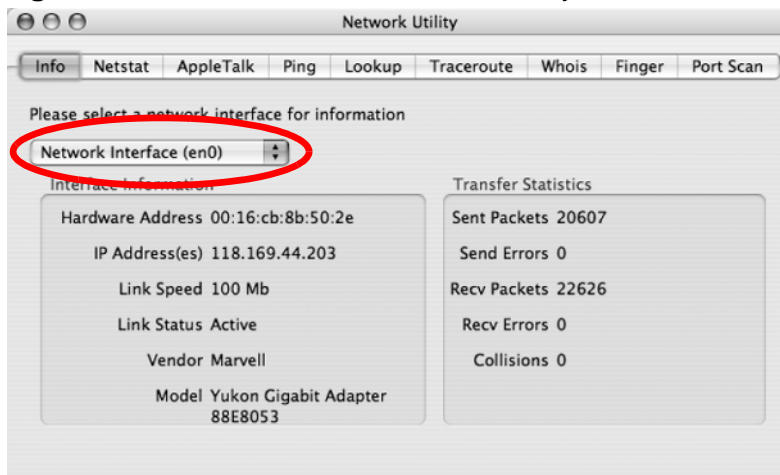
Figure 162 Mac OS X 10.4: Network Utility

Mac OS X: 10.5

The screens in this section are from Mac OS X 10.5.

- 1 Click **Apple** > **System Preferences**.

Figure 163 Mac OS X 10.5: Apple Menu

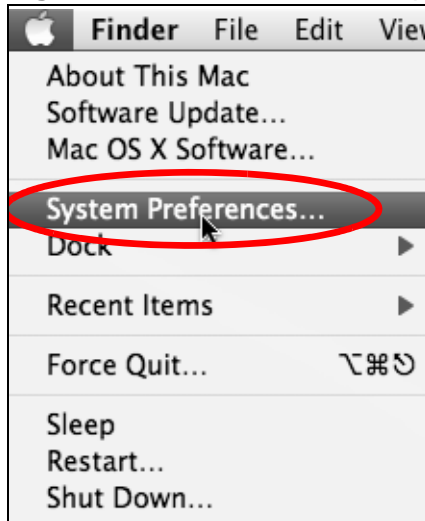

- 2 In **System Preferences**, click the **Network** icon.

Figure 164 Mac OS X 10.5: Systems Preferences



- 3 When the **Network** preferences pane opens, select **Ethernet** from the list of available connection types.

Figure 165 Mac OS X 10.5: Network Preferences > Ethernet

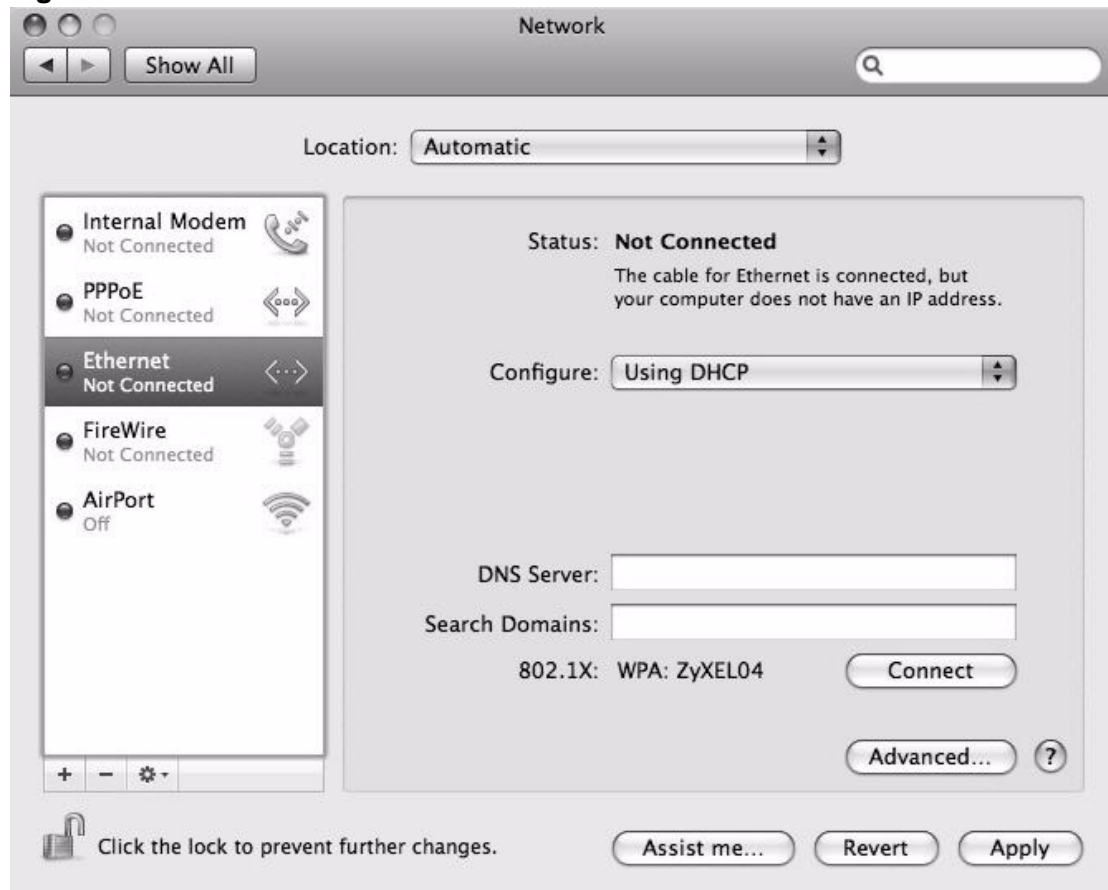

- 4 From the **Configure** list, select **Using DHCP** for dynamically assigned settings.
- 5 For statically assigned settings, do the following:
 - From the **Configure** list, select **Manually**.
 - In the **IP Address** field, enter your IP address.
 - In the **Subnet Mask** field, enter your subnet mask.

- In the **Router** field, enter the IP address of your ZyXEL Device.

Figure 166 Mac OS X 10.5: Network Preferences > Ethernet

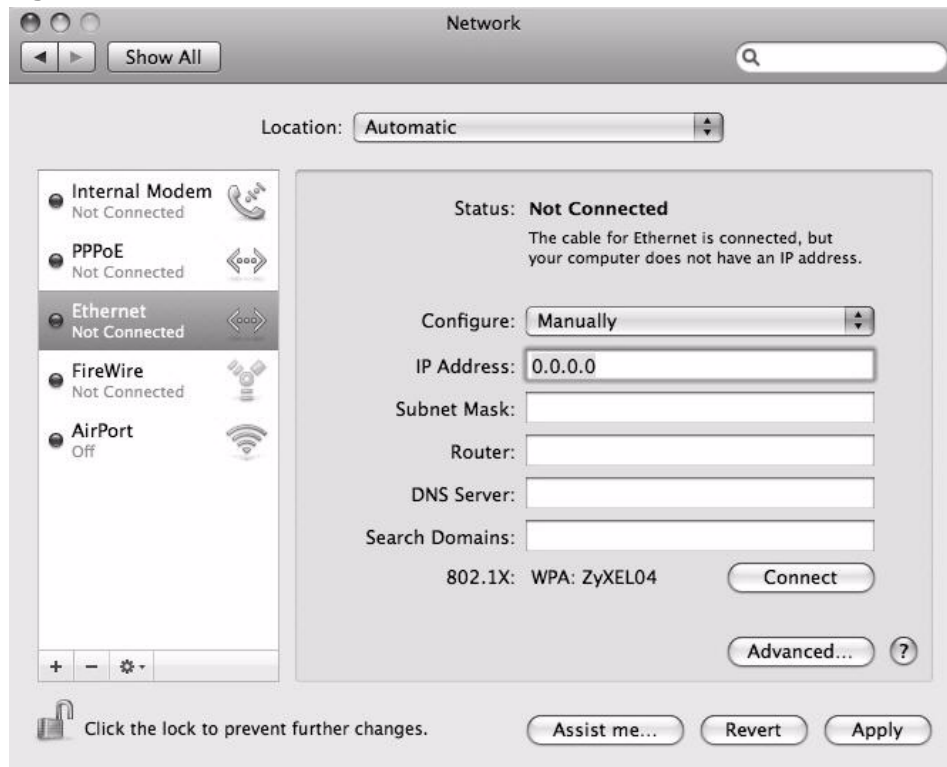

- 6 Click **Apply** and close the window.

Verifying Settings

Check your TCP/IP properties by clicking **Applications > Utilities > Network Utilities**, and then selecting the appropriate **Network interface** from the **Info** tab.

Figure 167 Mac OS X 10.5: Network Utility

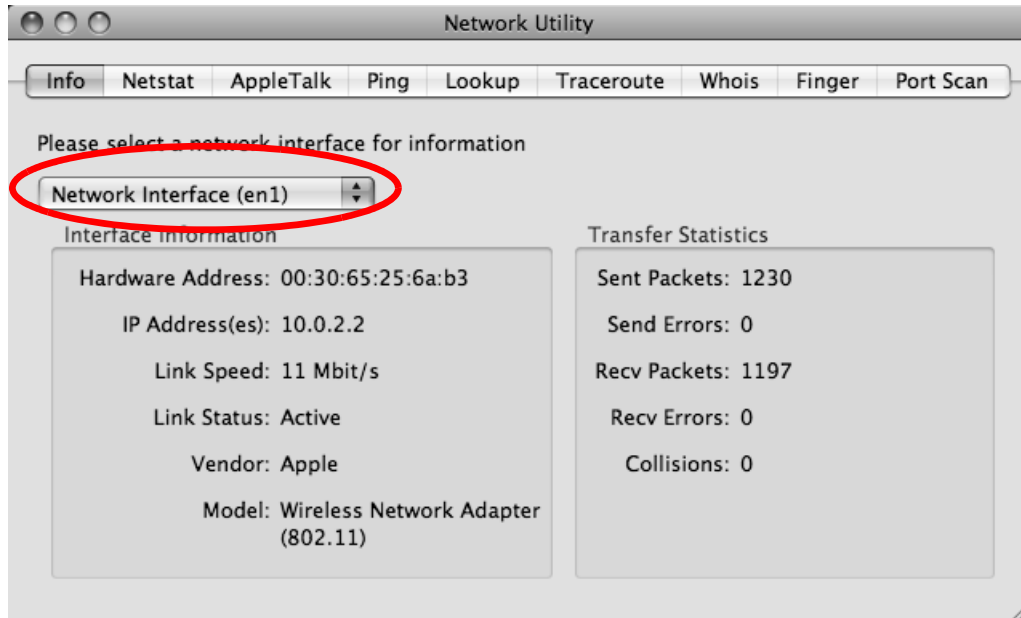

Linux: Ubuntu 8 (GNOME)

This section shows you how to configure your computer's TCP/IP settings in the GNU Object Model Environment (GNOME) using the Ubuntu 8 Linux distribution. The procedure, screens and file locations may vary depending on your specific distribution, release version, and individual configuration. The following screens use the default Ubuntu 8 installation.

Note: Make sure you are logged in as the root administrator.

Follow the steps below to configure your computer IP address in GNOME:

- 1 Click **System > Administration > Network**.

Figure 168 Ubuntu 8: System > Administration Menu

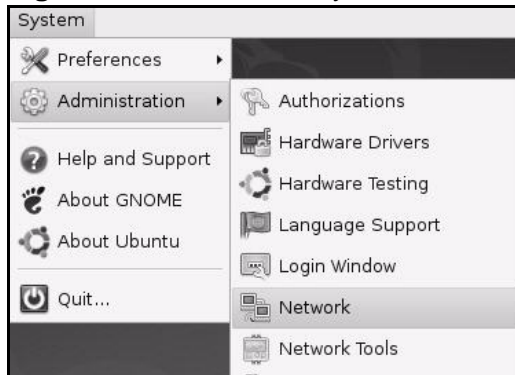

- 2 When the **Network Settings** window opens, click **Unlock** to open the **Authenticate** window. (By default, the **Unlock** button is greyed out until clicked.) You cannot make changes to your configuration unless you first enter your admin password.

Figure 169 Ubuntu 8: Network Settings > Connections

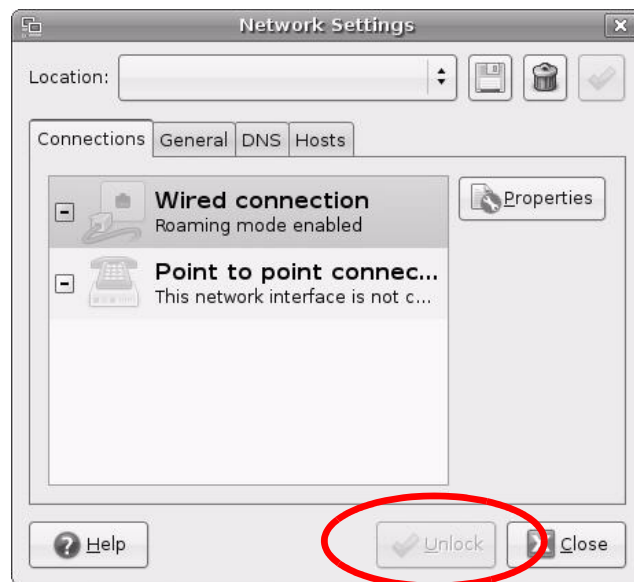

- 3 In the **Authenticate** window, enter your admin account name and password then click the **Authenticate** button.

Figure 170 Ubuntu 8: Administrator Account Authentication



- 4 In the **Network Settings** window, select the connection that you want to configure, then click **Properties**.

Figure 171 Ubuntu 8: Network Settings > Connections

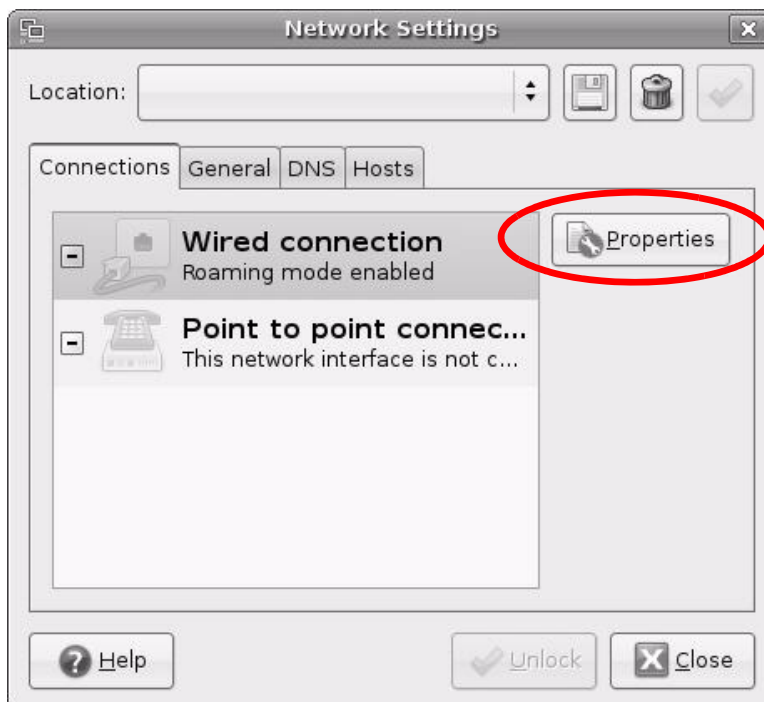

- 5 The **Properties** dialog box opens.

Figure 172 Ubuntu 8: Network Settings > Properties



- In the **Configuration** list, select **Automatic Configuration (DHCP)** if you have a dynamic IP address.
 - In the **Configuration** list, select **Static IP address** if you have a static IP address. Fill in the **IP address**, **Subnet mask**, and **Gateway address** fields.
- 6 Click **OK** to save the changes and close the **Properties** dialog box and return to the **Network Settings** screen.

- 7 If you know your DNS server IP address(es), click the **DNS** tab in the **Network Settings** window and then enter the DNS server information in the fields provided.

Figure 173 Ubuntu 8: Network Settings > DNS

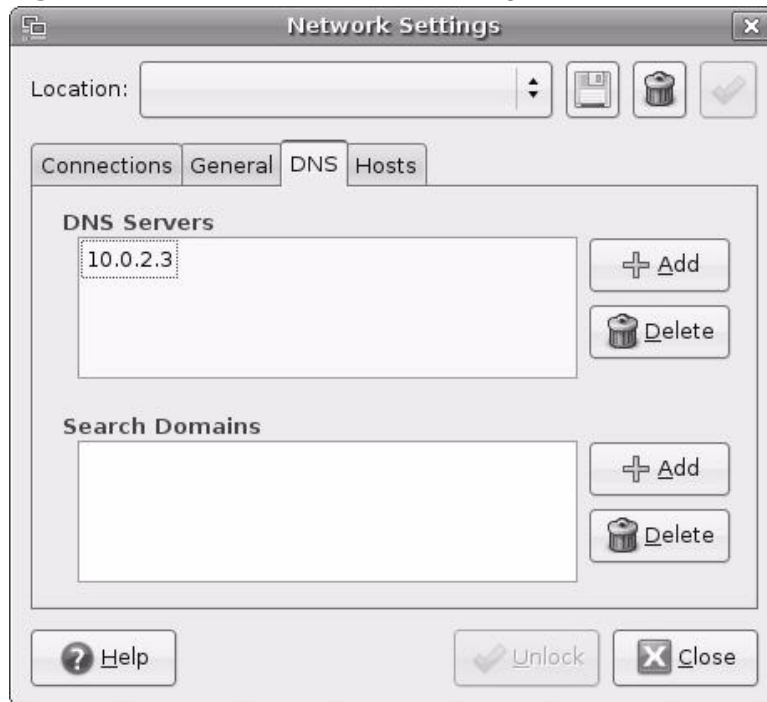

- 8 Click the **Close** button to apply the changes.

Verifying Settings

Check your TCP/IP properties by clicking **System > Administration > Network Tools**, and then selecting the appropriate **Network device** from the **Devices**

tab. The **Interface Statistics** column shows data if your connection is working properly.

Figure 174 Ubuntu 8: Network Tools

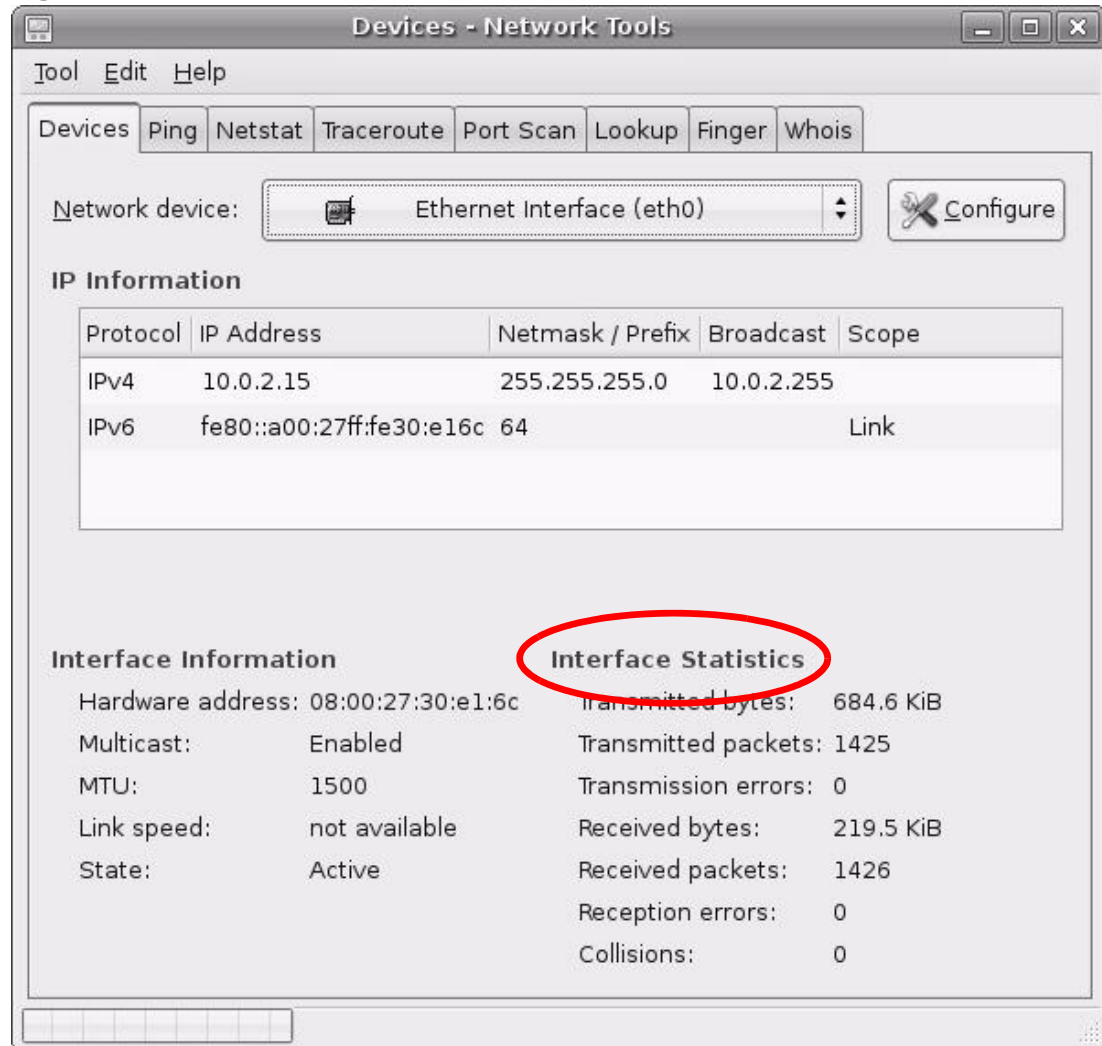

Linux: openSUSE 10.3 (KDE)

This section shows you how to configure your computer's TCP/IP settings in the K Desktop Environment (KDE) using the openSUSE 10.3 Linux distribution. The procedure, screens and file locations may vary depending on your specific distribution, release version, and individual configuration. The following screens use the default openSUSE 10.3 installation.

Note: Make sure you are logged in as the root administrator.

Follow the steps below to configure your computer IP address in the KDE:

- 1 Click **K Menu > Computer > Administrator Settings (YaST)**.

Figure 175 openSUSE 10.3: K Menu > Computer Menu

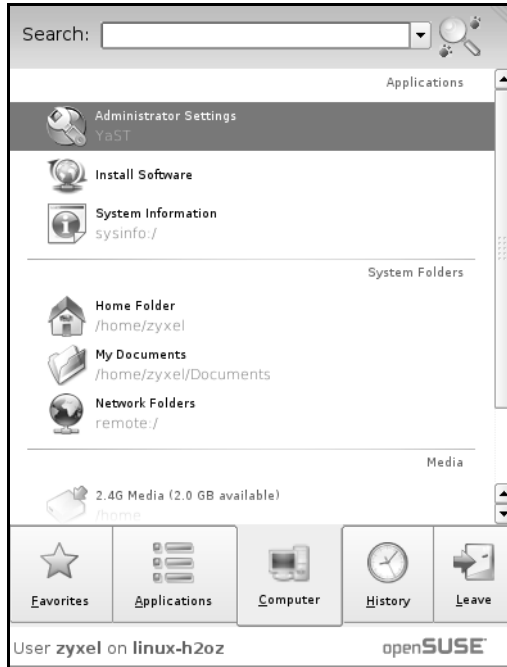

- 2 When the **Run as Root - KDE su** dialog opens, enter the admin password and click **OK**.

Figure 176 openSUSE 10.3: K Menu > Computer Menu

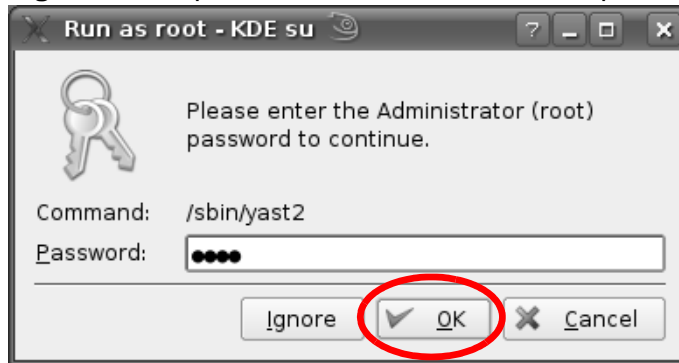

- 3 When the **YaST Control Center** window opens, select **Network Devices** and then click the **Network Card** icon.

Figure 177 openSUSE 10.3: YaST Control Center

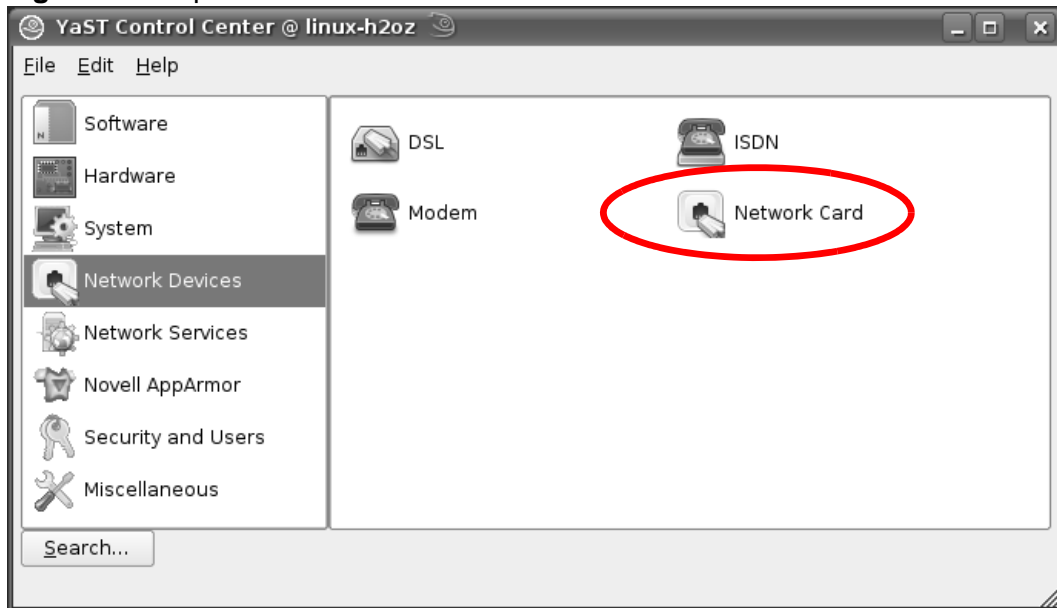

- 4 When the **Network Settings** window opens, click the **Overview** tab, select the appropriate connection **Name** from the list, and then click the **Configure** button.

Figure 178 openSUSE 10.3: Network Settings

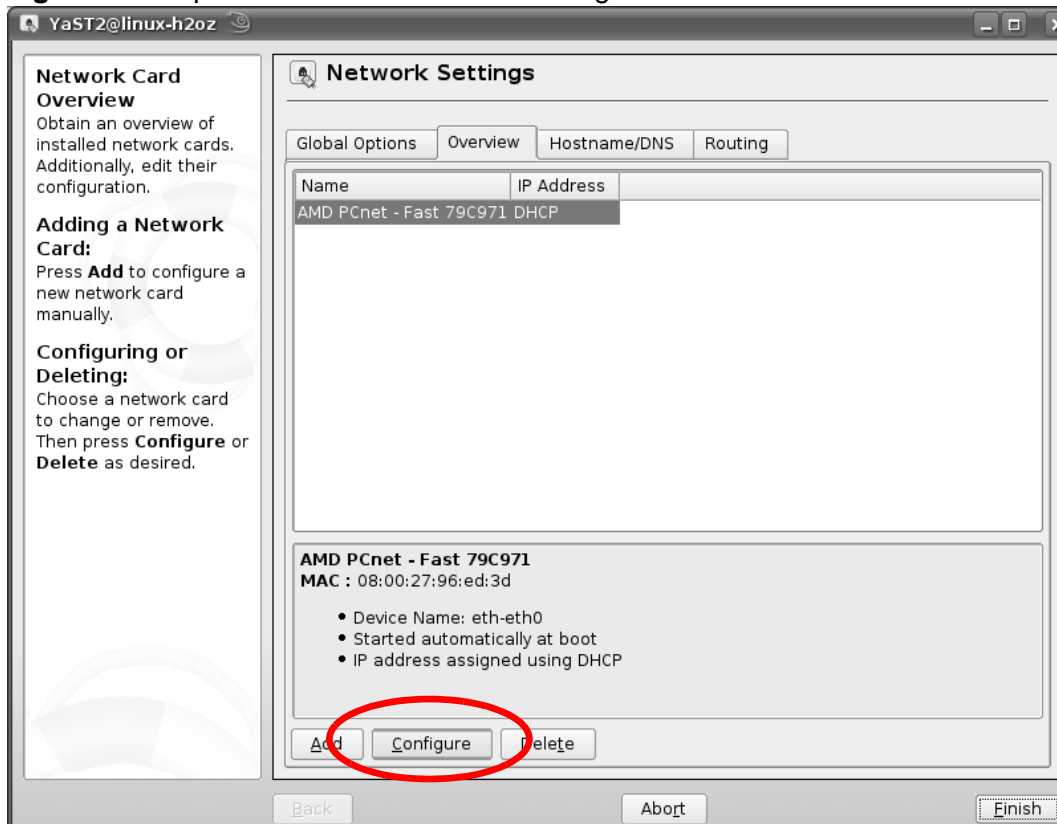

- 5 When the **Network Card Setup** window opens, click the **Address** tab

Figure 179 openSUSE 10.3: Network Card Setup

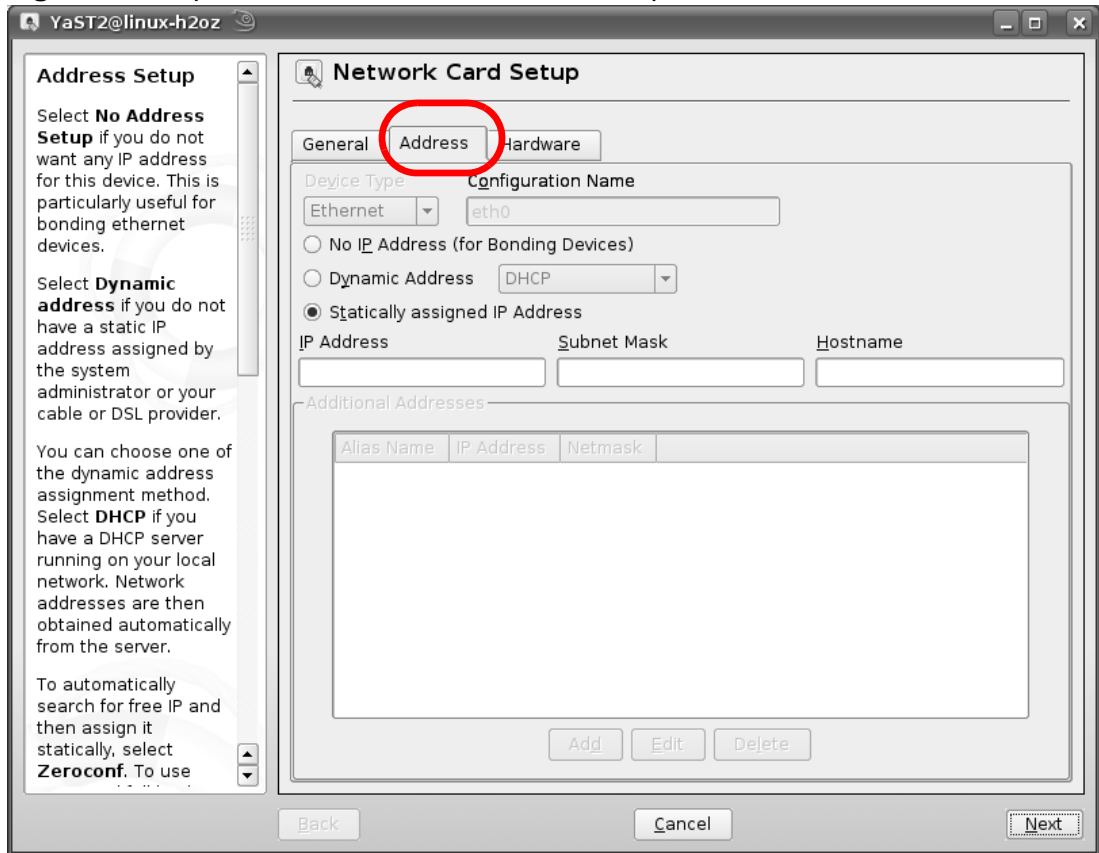

- 6 Select **Dynamic Address (DHCP)** if you have a dynamic IP address.
Select **Statically assigned IP Address** if you have a static IP address. Fill in the **IP address**, **Subnet mask**, and **Hostname** fields.
- 7 Click **Next** to save the changes and close the **Network Card Setup** window.

- 8 If you know your DNS server IP address(es), click the **Hostname/DNS** tab in **Network Settings** and then enter the DNS server information in the fields provided.

Figure 180 openSUSE 10.3: Network Settings

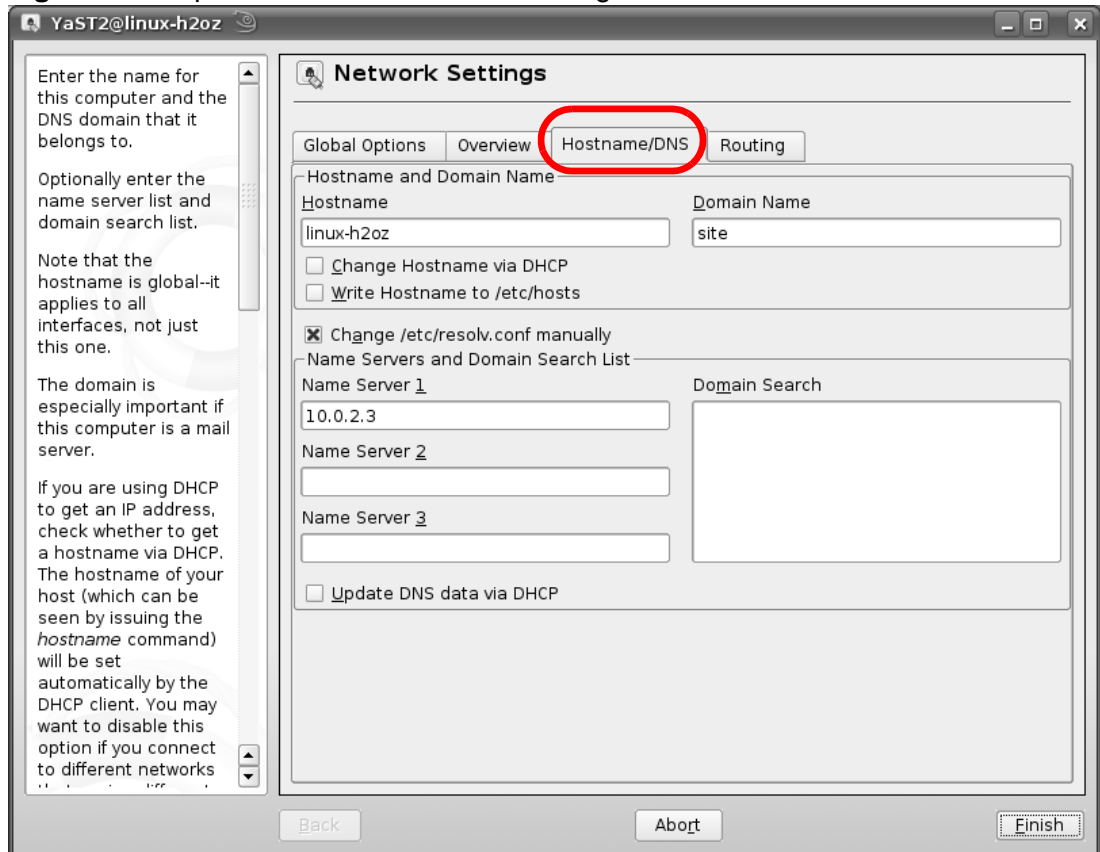

- 9 Click **Finish** to save your settings and close the window.

Verifying Settings

Click the **KNetwork Manager** icon on the **Task bar** to check your TCP/IP properties. From the **Options** sub-menu, select **Show Connection Information**.

Figure 181 openSUSE 10.3: KNetwork Manager

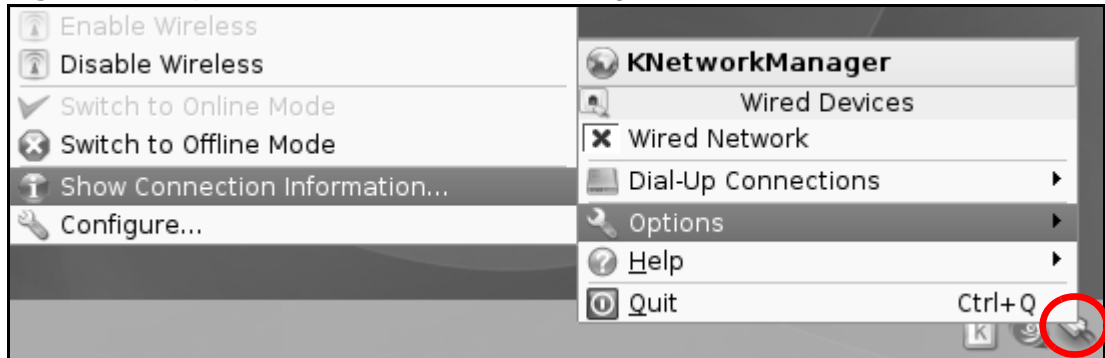

When the **Connection Status - KNetwork Manager** window opens, click the **Statistics** tab to see if your connection is working properly.

Figure 182 openSUSE: Connection Status - KNetwork Manager

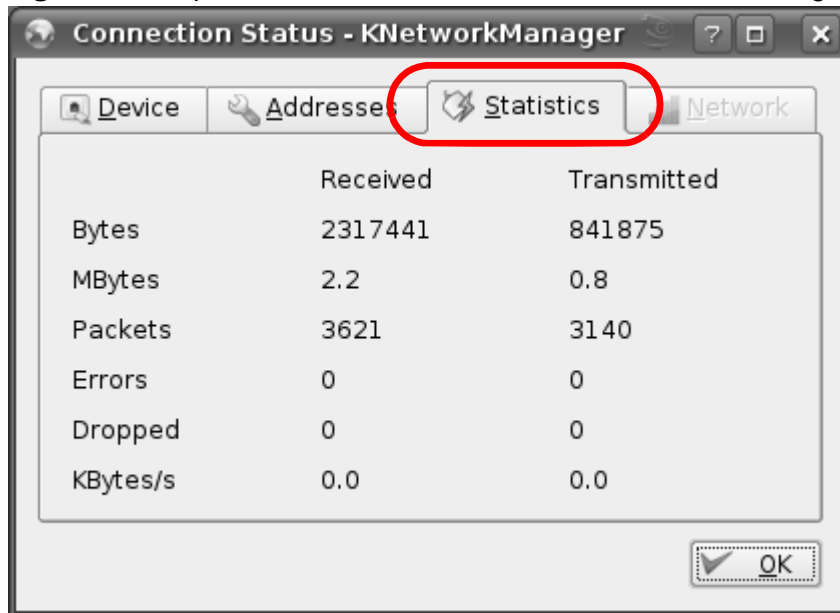

Pop-up Windows, JavaScript and Java Permissions

In order to use the web configurator you need to allow:

- Web browser pop-up windows from your device.
- JavaScript (enabled by default).
- Java permissions (enabled by default).

Note: Internet Explorer 6 screens are used here. Screens for other Internet Explorer versions may vary.

Internet Explorer Pop-up Blockers

You may have to disable pop-up blocking to log into your device.

Either disable pop-up blocking (enabled by default in Windows XP SP (Service Pack) 2) or allow pop-up blocking and create an exception for your device's IP address.

Disable Pop-up Blockers

- 1 In Internet Explorer, select **Tools, Pop-up Blocker** and then select **Turn Off Pop-up Blocker**.

Figure 183 Pop-up Blocker

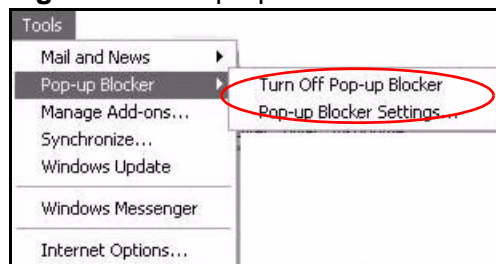

You can also check if pop-up blocking is disabled in the **Pop-up Blocker** section in the **Privacy** tab.

- 1 In Internet Explorer, select **Tools, Internet Options, Privacy**.
- 2 Clear the **Block pop-ups** check box in the **Pop-up Blocker** section of the screen. This disables any web pop-up blockers you may have enabled.

Figure 184 Internet Options: Privacy

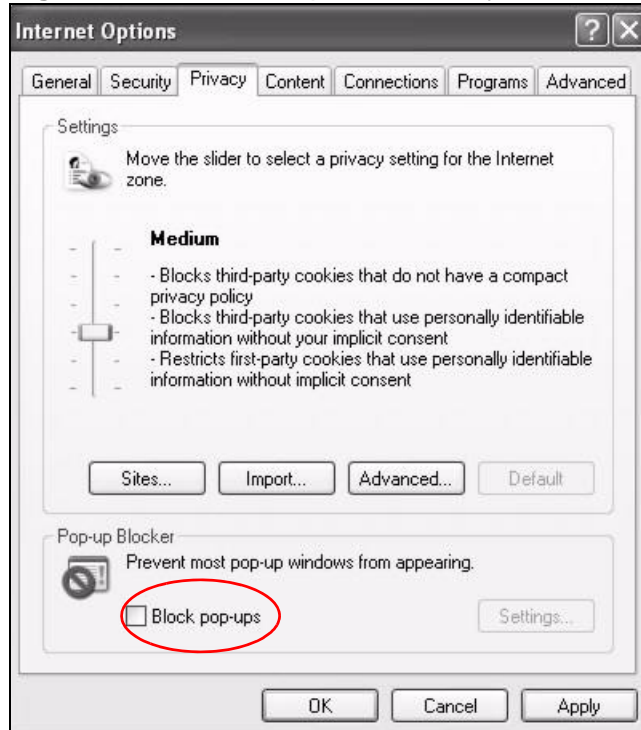

- 3 Click **Apply** to save this setting.

Enable Pop-up Blockers with Exceptions

Alternatively, if you only want to allow pop-up windows from your device, see the following steps.

- 1 In Internet Explorer, select **Tools, Internet Options** and then the **Privacy** tab.

- 2 Select **Settings...** to open the **Pop-up Blocker Settings** screen.

Figure 185 Internet Options: Privacy

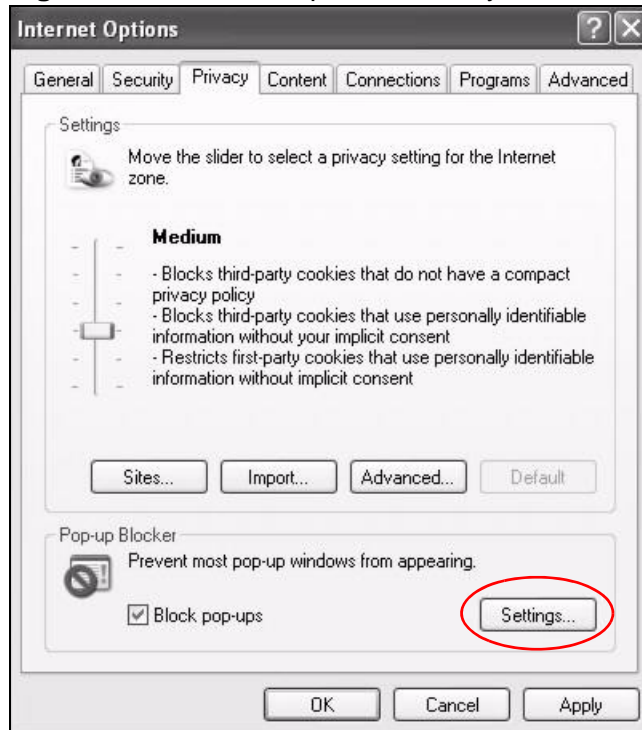

- 3 Type the IP address of your device (the web page that you do not want to have blocked) with the prefix "http://". For example, http://192.168.167.1.

- 4 Click **Add** to move the IP address to the list of **Allowed sites**.

Figure 186 Pop-up Blocker Settings

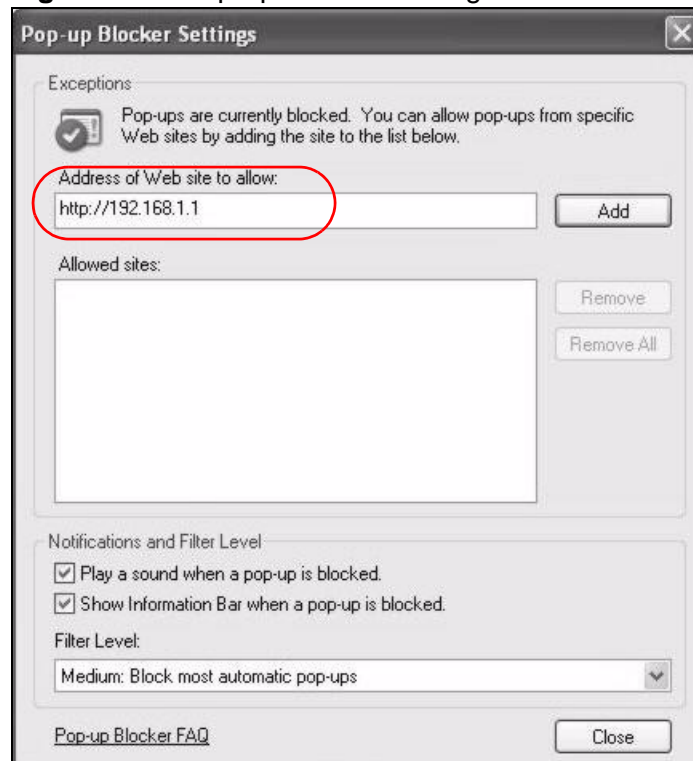

- 5 Click **Close** to return to the **Privacy** screen.
- 6 Click **Apply** to save this setting.

JavaScript

If pages of the web configurator do not display properly in Internet Explorer, check that JavaScript are allowed.

- 1 In Internet Explorer, click **Tools**, **Internet Options** and then the **Security** tab.

Figure 187 Internet Options: Security

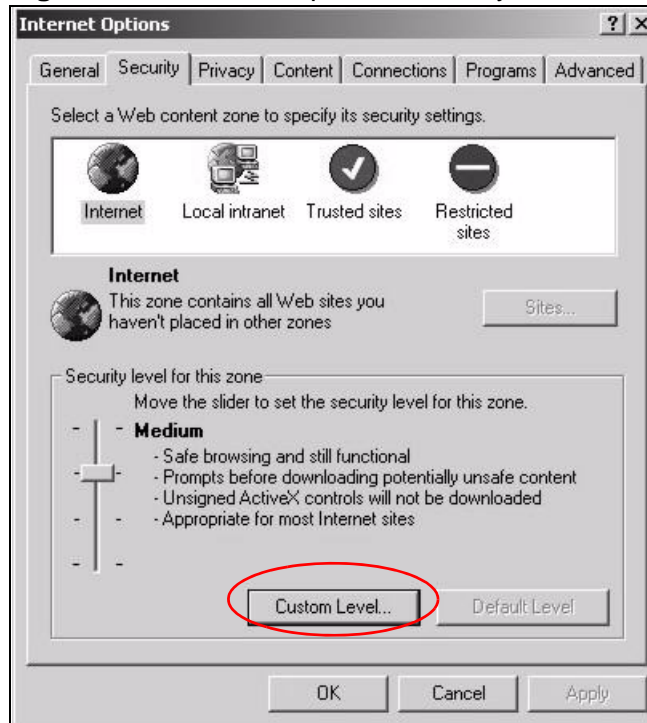

- 2 Click the **Custom Level...** button.
- 3 Scroll down to **Scripting**.
- 4 Under **Active scripting** make sure that **Enable** is selected (the default).
- 5 Under **Scripting of Java applets** make sure that **Enable** is selected (the default).

- 6 Click **OK** to close the window.

Figure 188 Security Settings - Java Scripting

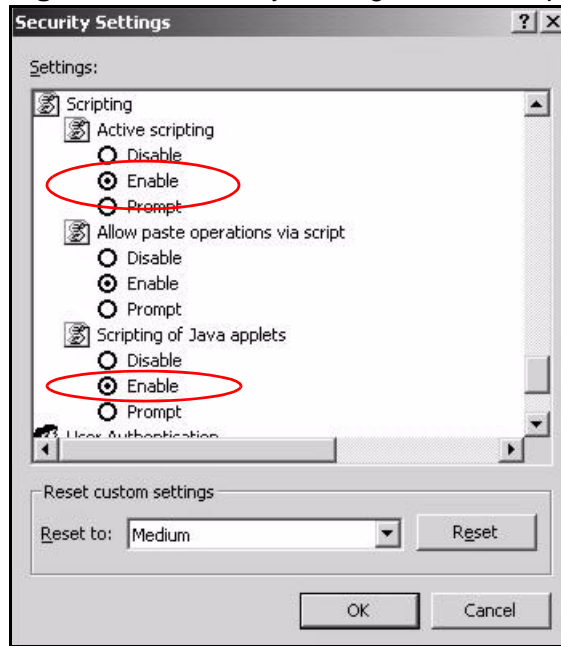

Java Permissions

- 1 From Internet Explorer, click **Tools, Internet Options** and then the **Security** tab.
- 2 Click the **Custom Level...** button.
- 3 Scroll down to **Microsoft VM**.
- 4 Under **Java permissions** make sure that a safety level is selected.

- 5 Click **OK** to close the window.

Figure 189 Security Settings - Java

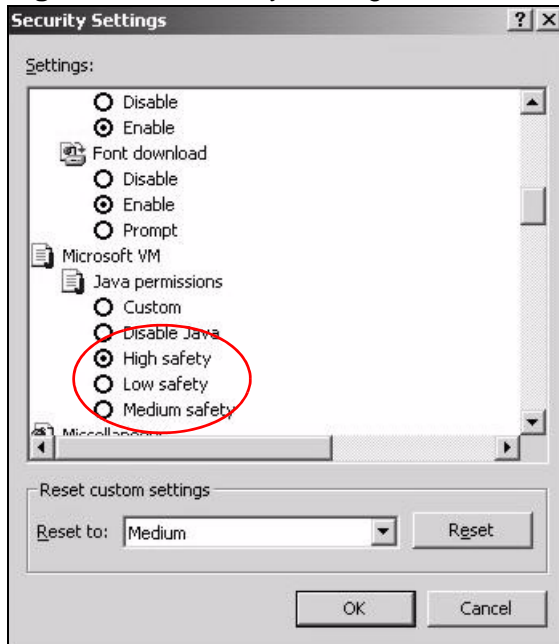

JAVA (Sun)

- 1 From Internet Explorer, click **Tools, Internet Options** and then the **Advanced** tab.
- 2 Make sure that **Use Java 2 for <applet>** under **Java (Sun)** is selected.

- 3 Click **OK** to close the window.

Figure 190 Java (Sun)

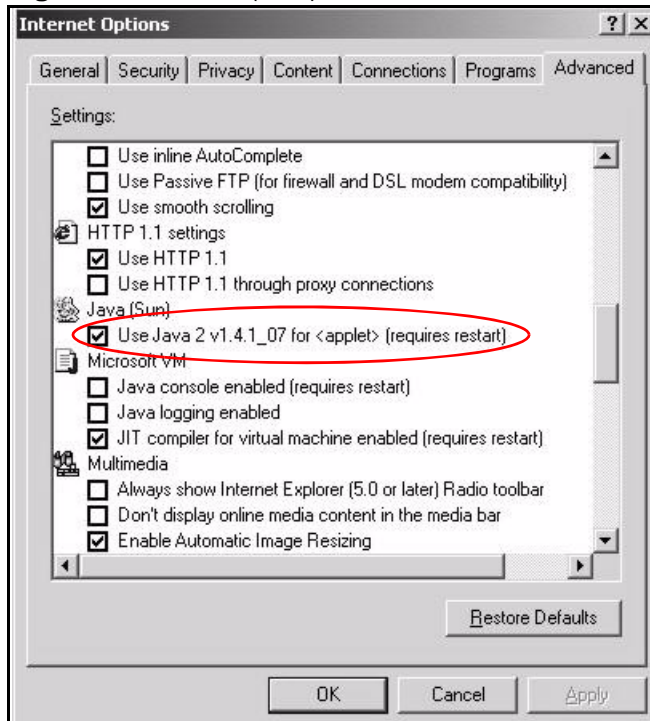

Mozilla Firefox

Mozilla Firefox 2.0 screens are used here. Screens for other versions may vary.

You can enable Java, JavaScript and pop-ups in one screen. Click **Tools**, then click **Options** in the screen that appears.

Figure 191 Mozilla Firefox: Tools > Options

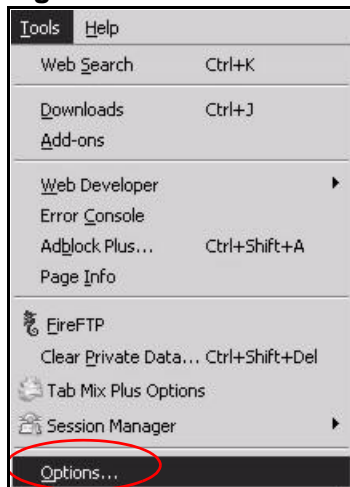

Click **Content** to show the screen below. Select the check boxes as shown in the following screen.

Figure 192 Mozilla Firefox Content Security

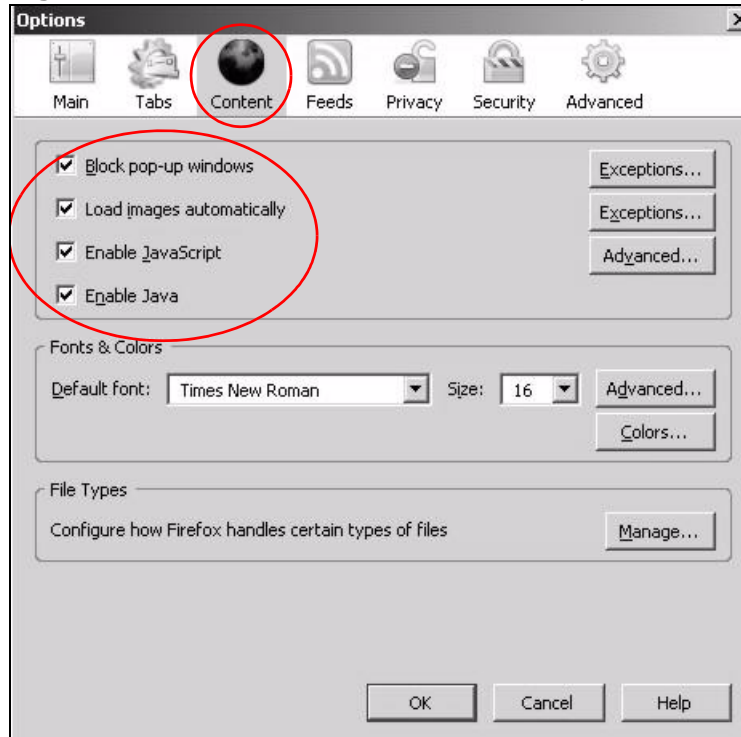

Wireless LANs

Wireless LAN Topologies

This section discusses ad-hoc and infrastructure wireless LAN topologies.

Ad-hoc Wireless LAN Configuration

The simplest WLAN configuration is an independent (Ad-hoc) WLAN that connects a set of computers with wireless adapters (A, B, C). Any time two or more wireless adapters are within range of each other, they can set up an independent network, which is commonly referred to as an ad-hoc network or Independent Basic Service Set (IBSS). The following diagram shows an example of notebook computers using wireless adapters to form an ad-hoc wireless LAN.

Figure 193 Peer-to-Peer Communication in an Ad-hoc Network

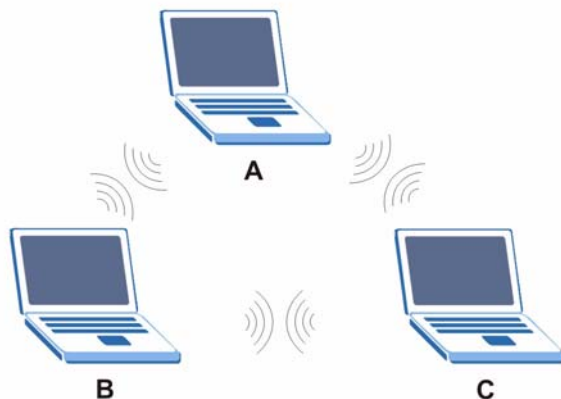

BSS

A Basic Service Set (BSS) exists when all communications between wireless clients or between a wireless client and a wired network client go through one access point (AP).

Intra-BSS traffic is traffic between wireless clients in the BSS. When Intra-BSS is enabled, wireless client **A** and **B** can access the wired network and communicate

with each other. When Intra-BSS is disabled, wireless client **A** and **B** can still access the wired network but cannot communicate with each other.

Figure 194 Basic Service Set

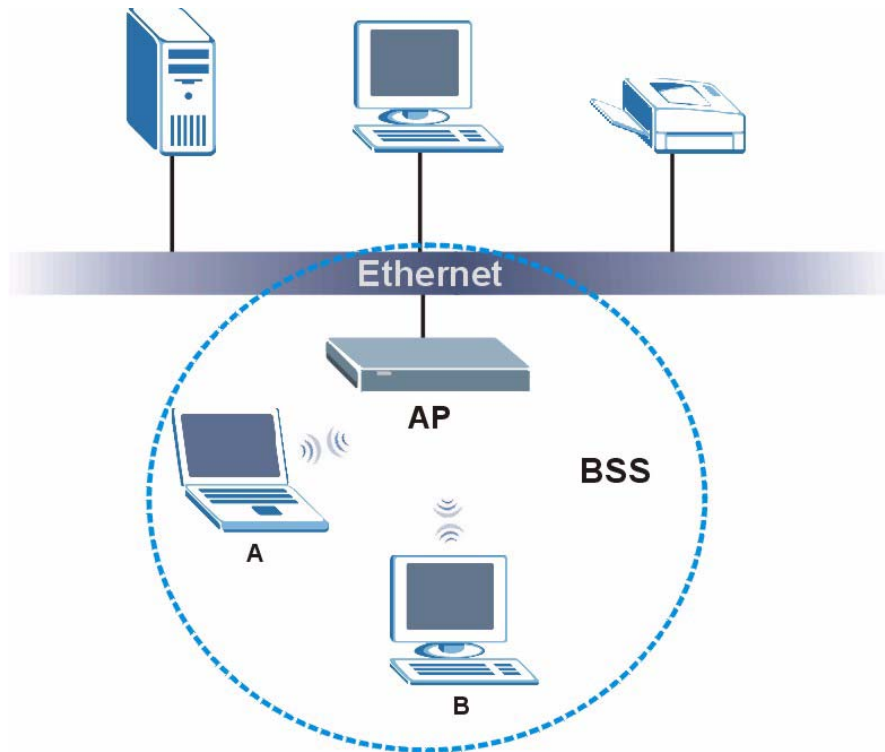

ESS

An Extended Service Set (ESS) consists of a series of overlapping BSSs, each containing an access point, with each access point connected together by a wired network. This wired connection between APs is called a Distribution System (DS).

This type of wireless LAN topology is called an Infrastructure WLAN. The Access Points not only provide communication with the wired network but also mediate wireless network traffic in the immediate neighborhood.

An ESSID (ESS IDentification) uniquely identifies each ESS. All access points and their associated wireless clients within the same ESS must have the same ESSID in order to communicate.

Figure 195 Infrastructure WLAN

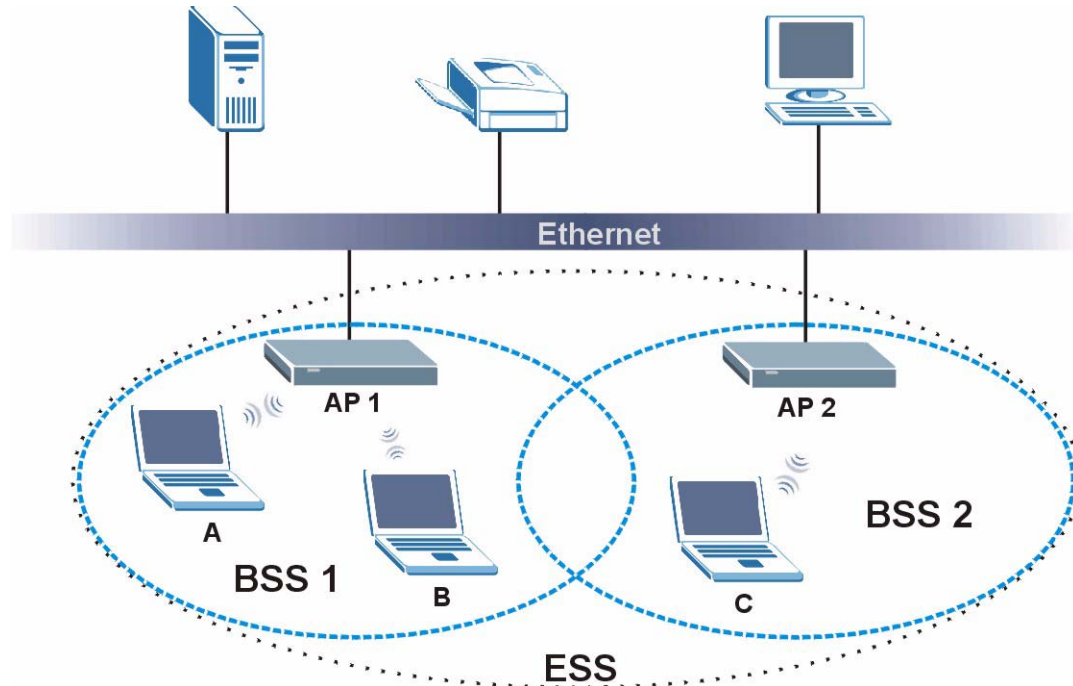

Channel

A channel is the radio frequency(ies) used by wireless devices to transmit and receive data. Channels available depend on your geographical area. You may have a choice of channels (for your region) so you should use a channel different from an adjacent AP (access point) to reduce interference. Interference occurs when radio signals from different access points overlap causing interference and degrading performance.

Adjacent channels partially overlap however. To avoid interference due to overlap, your AP should be on a channel at least five channels away from a channel that an adjacent AP is using. For example, if your region has 11 channels and an adjacent AP is using channel 1, then you need to select a channel between 6 or 11.

RTS/CTS

A hidden node occurs when two stations are within range of the same access point, but are not within range of each other. The following figure illustrates a hidden node. Both stations (STA) are within range of the access point (AP) or

wireless gateway, but out-of-range of each other, so they cannot "hear" each other, that is they do not know if the channel is currently being used. Therefore, they are considered hidden from each other.

Figure 196 RTS/CTS

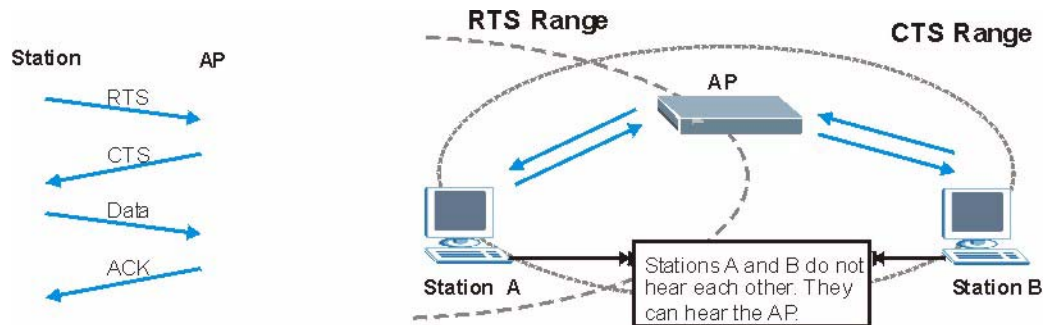

When station **A** sends data to the AP, it might not know that the station **B** is already using the channel. If these two stations send data at the same time, collisions may occur when both sets of data arrive at the AP at the same time, resulting in a loss of messages for both stations.

RTS/CTS is designed to prevent collisions due to hidden nodes. An **RTS/CTS** defines the biggest size data frame you can send before an RTS (Request To Send)/CTS (Clear to Send) handshake is invoked.

When a data frame exceeds the **RTS/CTS** value you set (between 0 to 2432 bytes), the station that wants to transmit this frame must first send an RTS (Request To Send) message to the AP for permission to send it. The AP then responds with a CTS (Clear to Send) message to all other stations within its range to notify them to defer their transmission. It also reserves and confirms with the requesting station the time frame for the requested transmission.

Stations can send frames smaller than the specified **RTS/CTS** directly to the AP without the RTS (Request To Send)/CTS (Clear to Send) handshake.

You should only configure **RTS/CTS** if the possibility of hidden nodes exists on your network and the "cost" of resending large frames is more than the extra network overhead involved in the RTS (Request To Send)/CTS (Clear to Send) handshake.

If the **RTS/CTS** value is greater than the **Fragmentation Threshold** value (see next), then the RTS (Request To Send)/CTS (Clear to Send) handshake will never occur as data frames will be fragmented before they reach **RTS/CTS** size.

Note: Enabling the RTS Threshold causes redundant network overhead that could negatively affect the throughput performance instead of providing a remedy.

Fragmentation Threshold

A **Fragmentation Threshold** is the maximum data fragment size (between 256 and 2432 bytes) that can be sent in the wireless network before the AP will fragment the packet into smaller data frames.

A large **Fragmentation Threshold** is recommended for networks not prone to interference while you should set a smaller threshold for busy networks or networks that are prone to interference.

If the **Fragmentation Threshold** value is smaller than the **RTS/CTS** value (see previously) you set then the RTS (Request To Send)/CTS (Clear to Send) handshake will never occur as data frames will be fragmented before they reach **RTS/CTS** size.

Preamble Type

Preamble is used to signal that data is coming to the receiver. Short and long refer to the length of the synchronization field in a packet.

Short preamble increases performance as less time sending preamble means more time for sending data. All IEEE 802.11 compliant wireless adapters support long preamble, but not all support short preamble.

Use long preamble if you are unsure what preamble mode other wireless devices on the network support, and to provide more reliable communications in busy wireless networks.

Use short preamble if you are sure all wireless devices on the network support it, and to provide more efficient communications.

Use the dynamic setting to automatically use short preamble when all wireless devices on the network support it, otherwise the ZyXEL Device uses long preamble.

Note: The wireless devices **MUST** use the same preamble mode in order to communicate.

IEEE 802.11g Wireless LAN

IEEE 802.11g is fully compatible with the IEEE 802.11b standard. This means an IEEE 802.11b adapter can interface directly with an IEEE 802.11g access point (and vice versa) at 11 Mbps or lower depending on range. IEEE 802.11g has

several intermediate rate steps between the maximum and minimum data rates. The IEEE 802.11g data rate and modulation are as follows:

Table 99 IEEE 802.11g

DATA RATE (MBPS)	MODULATION
1	DBPSK (Differential Binary Phase Shift Keyed)
2	DQPSK (Differential Quadrature Phase Shift Keying)
5.5 / 11	CCK (Complementary Code Keying)
6/9/12/18/24/36/ 48/54	OFDM (Orthogonal Frequency Division Multiplexing)

Wireless Security Overview

Wireless security is vital to your network to protect wireless communication between wireless clients, access points and the wired network.

Wireless security methods available on the ZyXEL Device are data encryption, wireless client authentication, restricting access by device MAC address and hiding the ZyXEL Device identity.

The following figure shows the relative effectiveness of these wireless security methods available on your ZyXEL Device.

Table 100 Wireless Security Levels

SECURITY LEVEL	SECURITY TYPE
Least Secure	Unique SSID (Default)
	Unique SSID with Hide SSID Enabled
	MAC Address Filtering
	WEP Encryption
	IEEE802.1x EAP with RADIUS Server Authentication
	Wi-Fi Protected Access (WPA)
	WPA2
Most Secure	

Note: You must enable the same wireless security settings on the ZyXEL Device and on all wireless clients that you want to associate with it.

IEEE 802.1x

In June 2001, the IEEE 802.1x standard was designed to extend the features of IEEE 802.11 to support extended authentication as well as providing additional accounting and control features. It is supported by Windows XP and a number of network devices. Some advantages of IEEE 802.1x are:

- User based identification that allows for roaming.
- Support for RADIUS (Remote Authentication Dial In User Service, RFC 2138, 2139) for centralized user profile and accounting management on a network RADIUS server.
- Support for EAP (Extensible Authentication Protocol, RFC 2486) that allows additional authentication methods to be deployed with no changes to the access point or the wireless clients.

RADIUS

RADIUS is based on a client-server model that supports authentication, authorization and accounting. The access point is the client and the server is the RADIUS server. The RADIUS server handles the following tasks:

- Authentication
Determines the identity of the users.
- Authorization
Determines the network services available to authenticated users once they are connected to the network.
- Accounting
Keeps track of the client's network activity.

RADIUS is a simple package exchange in which your AP acts as a message relay between the wireless client and the network RADIUS server.

Types of RADIUS Messages

The following types of RADIUS messages are exchanged between the access point and the RADIUS server for user authentication:

- Access-Request
Sent by an access point requesting authentication.
- Access-Reject
Sent by a RADIUS server rejecting access.
- Access-Accept
Sent by a RADIUS server allowing access.

- Access-Challenge

Sent by a RADIUS server requesting more information in order to allow access. The access point sends a proper response from the user and then sends another Access-Request message.

The following types of RADIUS messages are exchanged between the access point and the RADIUS server for user accounting:

- Accounting-Request

Sent by the access point requesting accounting.

- Accounting-Response

Sent by the RADIUS server to indicate that it has started or stopped accounting.

In order to ensure network security, the access point and the RADIUS server use a shared secret key, which is a password, they both know. The key is not sent over the network. In addition to the shared key, password information exchanged is also encrypted to protect the network from unauthorized access.

Types of EAP Authentication

This section discusses some popular authentication types: EAP-MD5, EAP-TLS, EAP-TTLS, PEAP and LEAP. Your wireless LAN device may not support all authentication types.

EAP (Extensible Authentication Protocol) is an authentication protocol that runs on top of the IEEE 802.1x transport mechanism in order to support multiple types of user authentication. By using EAP to interact with an EAP-compatible RADIUS server, an access point helps a wireless station and a RADIUS server perform authentication.

The type of authentication you use depends on the RADIUS server and an intermediary AP(s) that supports IEEE 802.1x. .

For EAP-TLS authentication type, you must first have a wired connection to the network and obtain the certificate(s) from a certificate authority (CA). A certificate (also called digital IDs) can be used to authenticate users and a CA issues certificates and guarantees the identity of each certificate owner.

EAP-MD5 (Message-Digest Algorithm 5)

MD5 authentication is the simplest one-way authentication method. The authentication server sends a challenge to the wireless client. The wireless client 'proves' that it knows the password by encrypting the password with the challenge and sends back the information. Password is not sent in plain text.

However, MD5 authentication has some weaknesses. Since the authentication server needs to get the plaintext passwords, the passwords must be stored. Thus someone other than the authentication server may access the password file. In addition, it is possible to impersonate an authentication server as MD5 authentication method does not perform mutual authentication. Finally, MD5 authentication method does not support data encryption with dynamic session key. You must configure WEP encryption keys for data encryption.

EAP-TLS (Transport Layer Security)

With EAP-TLS, digital certifications are needed by both the server and the wireless clients for mutual authentication. The server presents a certificate to the client. After validating the identity of the server, the client sends a different certificate to the server. The exchange of certificates is done in the open before a secured tunnel is created. This makes user identity vulnerable to passive attacks. A digital certificate is an electronic ID card that authenticates the sender's identity. However, to implement EAP-TLS, you need a Certificate Authority (CA) to handle certificates, which imposes a management overhead.

EAP-TTLS (Tunneled Transport Layer Service)

EAP-TTLS is an extension of the EAP-TLS authentication that uses certificates for only the server-side authentications to establish a secure connection. Client authentication is then done by sending username and password through the secure connection, thus client identity is protected. For client authentication, EAP-TTLS supports EAP methods and legacy authentication methods such as PAP, CHAP, MS-CHAP and MS-CHAP v2.

PEAP (Protected EAP)

Like EAP-TTLS, server-side certificate authentication is used to establish a secure connection, then use simple username and password methods through the secured connection to authenticate the clients, thus hiding client identity. However, PEAP only supports EAP methods, such as EAP-MD5, EAP-MSCHAPv2 and EAP-GTC (EAP-Generic Token Card), for client authentication. EAP-GTC is implemented only by Cisco.

LEAP

LEAP (Lightweight Extensible Authentication Protocol) is a Cisco implementation of IEEE 802.1x.

Dynamic WEP Key Exchange

The AP maps a unique key that is generated with the RADIUS server. This key expires when the wireless connection times out, disconnects or reauthentication times out. A new WEP key is generated each time reauthentication is performed.

If this feature is enabled, it is not necessary to configure a default encryption key in the wireless security configuration screen. You may still configure and store keys, but they will not be used while dynamic WEP is enabled.

Note: EAP-MD5 cannot be used with Dynamic WEP Key Exchange

For added security, certificate-based authentications (EAP-TLS, EAP-TTLS and PEAP) use dynamic keys for data encryption. They are often deployed in corporate environments, but for public deployment, a simple user name and password pair is more practical. The following table is a comparison of the features of authentication types.

Table 101 Comparison of EAP Authentication Types

	EAP-MD5	EAP-TLS	EAP-TTLS	PEAP	LEAP
Mutual Authentication	No	Yes	Yes	Yes	Yes
Certificate – Client	No	Yes	Optional	Optional	No
Certificate – Server	No	Yes	Yes	Yes	No
Dynamic Key Exchange	No	Yes	Yes	Yes	Yes
Credential Integrity	None	Strong	Strong	Strong	Moderate
Deployment Difficulty	Easy	Hard	Moderate	Moderate	Moderate
Client Identity Protection	No	No	Yes	Yes	No

WPA and WPA2

Wi-Fi Protected Access (WPA) is a subset of the IEEE 802.11i standard. WPA2 (IEEE 802.11i) is a wireless security standard that defines stronger encryption, authentication and key management than WPA.

Key differences between WPA or WPA2 and WEP are improved data encryption and user authentication.

If both an AP and the wireless clients support WPA2 and you have an external RADIUS server, use WPA2 for stronger data encryption. If you don't have an external RADIUS server, you should use WPA2-PSK (WPA2-Pre-Shared Key) that only requires a single (identical) password entered into each access point, wireless gateway and wireless client. As long as the passwords match, a wireless client will be granted access to a WLAN.

If the AP or the wireless clients do not support WPA2, just use WPA or WPA-PSK depending on whether you have an external RADIUS server or not.

Select WEP only when the AP and/or wireless clients do not support WPA or WPA2. WEP is less secure than WPA or WPA2.

Encryption

Both WPA and WPA2 improve data encryption by using Temporal Key Integrity Protocol (TKIP), Message Integrity Check (MIC) and IEEE 802.1x. WPA and WPA2 use Advanced Encryption Standard (AES) in the Counter mode with Cipher block chaining Message authentication code Protocol (CCMP) to offer stronger encryption than TKIP.

TKIP uses 128-bit keys that are dynamically generated and distributed by the authentication server. AES (Advanced Encryption Standard) is a block cipher that uses a 256-bit mathematical algorithm called Rijndael. They both include a per-packet key mixing function, a Message Integrity Check (MIC) named Michael, an extended initialization vector (IV) with sequencing rules, and a re-keying mechanism.

WPA and WPA2 regularly change and rotate the encryption keys so that the same encryption key is never used twice.

The RADIUS server distributes a Pairwise Master Key (PMK) key to the AP that then sets up a key hierarchy and management system, using the PMK to dynamically generate unique data encryption keys to encrypt every data packet that is wirelessly communicated between the AP and the wireless clients. This all happens in the background automatically.

The Message Integrity Check (MIC) is designed to prevent an attacker from capturing data packets, altering them and resending them. The MIC provides a strong mathematical function in which the receiver and the transmitter each compute and then compare the MIC. If they do not match, it is assumed that the data has been tampered with and the packet is dropped.

By generating unique data encryption keys for every data packet and by creating an integrity checking mechanism (MIC), with TKIP and AES it is more difficult to decrypt data on a Wi-Fi network than WEP and difficult for an intruder to break into the network.

The encryption mechanisms used for WPA(2) and WPA(2)-PSK are the same. The only difference between the two is that WPA(2)-PSK uses a simple common password, instead of user-specific credentials. The common-password approach makes WPA(2)-PSK susceptible to brute-force password-guessing attacks but it's still an improvement over WEP as it employs a consistent, single, alphanumeric password to derive a PMK which is used to generate unique temporal encryption

keys. This prevent all wireless devices sharing the same encryption keys. (a weakness of WEP)

User Authentication

WPA and WPA2 apply IEEE 802.1x and Extensible Authentication Protocol (EAP) to authenticate wireless clients using an external RADIUS database. WPA2 reduces the number of key exchange messages from six to four (CCMP 4-way handshake) and shortens the time required to connect to a network. Other WPA2 authentication features that are different from WPA include key caching and pre-authentication. These two features are optional and may not be supported in all wireless devices.

Key caching allows a wireless client to store the PMK it derived through a successful authentication with an AP. The wireless client uses the PMK when it tries to connect to the same AP and does not need to go with the authentication process again.

Pre-authentication enables fast roaming by allowing the wireless client (already connecting to an AP) to perform IEEE 802.1x authentication with another AP before connecting to it.

Wireless Client WPA Supplicants

A wireless client supplicant is the software that runs on an operating system instructing the wireless client how to use WPA. At the time of writing, the most widely available supplicant is the WPA patch for Windows XP, Funk Software's Odyssey client.

The Windows XP patch is a free download that adds WPA capability to Windows XP's built-in "Zero Configuration" wireless client. However, you must run Windows XP to use it.

WPA(2) with RADIUS Application Example

To set up WPA(2), you need the IP address of the RADIUS server, its port number (default is 1812), and the RADIUS shared secret. A WPA(2) application example with an external RADIUS server looks as follows. "A" is the RADIUS server. "DS" is the distribution system.

- 1 The AP passes the wireless client's authentication request to the RADIUS server.
- 2 The RADIUS server then checks the user's identification against its database and grants or denies network access accordingly.
- 3 A 256-bit Pairwise Master Key (PMK) is derived from the authentication process by the RADIUS server and the client.

- 4 The RADIUS server distributes the PMK to the AP. The AP then sets up a key hierarchy and management system, using the PMK to dynamically generate unique data encryption keys. The keys are used to encrypt every data packet that is wirelessly communicated between the AP and the wireless clients.

Figure 197 WPA(2) with RADIUS Application Example

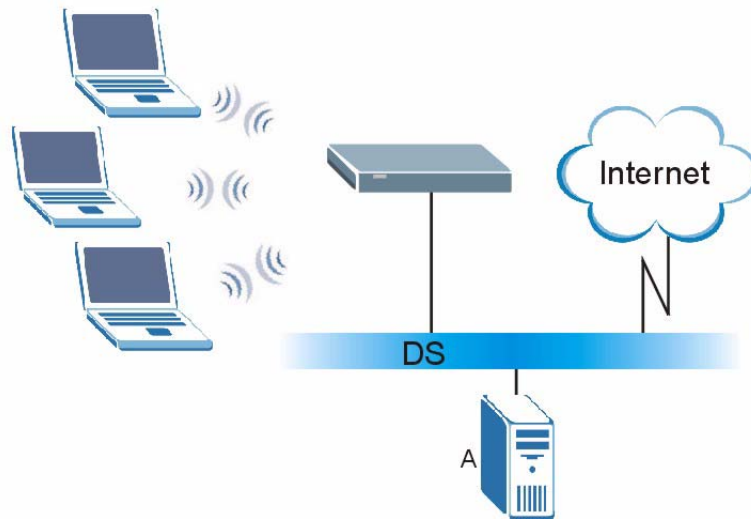

WPA(2)-PSK Application Example

A WPA(2)-PSK application looks as follows.

- 1 First enter identical passwords into the AP and all wireless clients. The Pre-Shared Key (PSK) must consist of between 8 and 63 ASCII characters or 64 hexadecimal characters (including spaces and symbols).
- 2 The AP checks each wireless client's password and allows it to join the network only if the password matches.
- 3 The AP and wireless clients generate a common PMK (Pairwise Master Key). The key itself is not sent over the network, but is derived from the PSK and the SSID.

- 4 The AP and wireless clients use the TKIP or AES encryption process, the PMK and information exchanged in a handshake to create temporal encryption keys. They use these keys to encrypt data exchanged between them.

Figure 198 WPA(2)-PSK Authentication

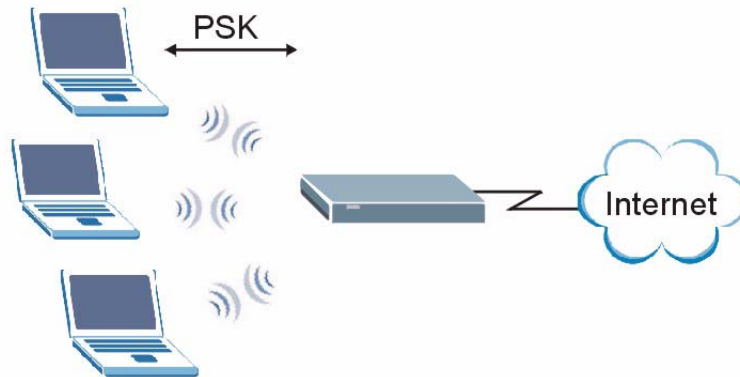

Security Parameters Summary

Refer to this table to see what other security parameters you should configure for each authentication method or key management protocol type. MAC address filters are not dependent on how you configure these security features.

Table 102 Wireless Security Relational Matrix

AUTHENTICATION METHOD/ KEY MANAGEMENT PROTOCOL	ENCRYPTION METHOD	ENTER MANUAL KEY	IEEE 802.1X
Open	None	No	Disable
			Enable without Dynamic WEP Key
Open	WEP	No	Enable with Dynamic WEP Key
		Yes	Enable without Dynamic WEP Key
		Yes	Disable
Shared	WEP	No	Enable with Dynamic WEP Key
		Yes	Enable without Dynamic WEP Key
		Yes	Disable
WPA	TKIP/AES	No	Enable
WPA-PSK	TKIP/AES	Yes	Disable
WPA2	TKIP/AES	No	Enable
WPA2-PSK	TKIP/AES	Yes	Disable

Antenna Overview

An antenna couples RF signals onto air. A transmitter within a wireless device sends an RF signal to the antenna, which propagates the signal through the air. The antenna also operates in reverse by capturing RF signals from the air.

Positioning the antennas properly increases the range and coverage area of a wireless LAN.

Antenna Characteristics

Frequency

An antenna in the frequency of 2.4GHz (IEEE 802.11b and IEEE 802.11g) or 5GHz (IEEE 802.11a) is needed to communicate efficiently in a wireless LAN

Radiation Pattern

A radiation pattern is a diagram that allows you to visualize the shape of the antenna's coverage area.

Antenna Gain

Antenna gain, measured in dB (decibel), is the increase in coverage within the RF beam width. Higher antenna gain improves the range of the signal for better communications.

For an indoor site, each 1 dB increase in antenna gain results in a range increase of approximately 2.5%. For an unobstructed outdoor site, each 1dB increase in gain results in a range increase of approximately 5%. Actual results may vary depending on the network environment.

Antenna gain is sometimes specified in dBi, which is how much the antenna increases the signal power compared to using an isotropic antenna. An isotropic antenna is a theoretical perfect antenna that sends out radio signals equally well in all directions. dBi represents the true gain that the antenna provides.

Types of Antennas for WLAN

There are two types of antennas used for wireless LAN applications.

- Omni-directional antennas send the RF signal out in all directions on a horizontal plane. The coverage area is torus-shaped (like a donut) which makes these antennas ideal for a room environment. With a wide coverage area, it is possible to make circular overlapping coverage areas with multiple access points.
- Directional antennas concentrate the RF signal in a beam, like a flashlight does with the light from its bulb. The angle of the beam determines the width of the coverage pattern. Angles typically range from 20 degrees (very directional) to 120 degrees (less directional). Directional antennas are ideal for hallways and outdoor point-to-point applications.

Positioning Antennas

In general, antennas should be mounted as high as practically possible and free of obstructions. In point-to-point application, position both antennas at the same height and in a direct line of sight to each other to attain the best performance.

For omni-directional antennas mounted on a table, desk, and so on, point the antenna up. For omni-directional antennas mounted on a wall or ceiling, point the antenna down. For a single AP application, place omni-directional antennas as close to the center of the coverage area as possible.

For directional antennas, point the antenna in the direction of the desired coverage area.

WiFi Protected Setup

Your ZyXEL Device supports WiFi Protected Setup (WPS), which is an easy way to set up a secure wireless network. WPS is an industry standard specification, defined by the WiFi Alliance.

WPS allows you to quickly set up a wireless network with strong security, without having to configure security settings manually. Each WPS connection works between two devices. Both devices must support WPS (check each device's documentation to make sure).

Depending on the devices you have, you can either press a button (on the device itself, or in its configuration utility) or enter a PIN (a unique Personal Identification Number that allows one device to authenticate the other) in each of the two devices. When WPS is activated on a device, it has two minutes to find another device that also has WPS activated. Then, the two devices connect and set up a secure network by themselves.

Push Button Configuration

WPS Push Button Configuration (PBC) is initiated by pressing a button on each WPS-enabled device, and allowing them to connect automatically. You do not need to enter any information.

Not every WPS-enabled device has a physical WPS button. Some may have a WPS PBC button in their configuration utilities instead of or in addition to the physical button.

Take the following steps to set up WPS using the button.

- 1 Ensure that the two devices you want to set up are within wireless range of one another.
- 2 Look for a WPS button on each device. If the device does not have one, log into its configuration utility and locate the button (see the device's User's Guide for how to do this - for the ZyXEL Device, see [Section 6.4 on page 135](#)).
- 3 Press the button on one of the devices (it doesn't matter which).
- 4 Within two minutes, press the button on the other device. The registrar sends the network name (SSID) and security key through an secure connection to the enrollee.

If you need to make sure that WPS worked, check the list of associated wireless clients in the AP's configuration utility. If you see the wireless client in the list, WPS was successful.

PIN Configuration

Each WPS-enabled device has its own PIN (Personal Identification Number). This may either be static (it cannot be changed) or dynamic (you can change it to a new random number by clicking on a button in the configuration interface).

When you use the PIN method, you must enter the enrollee's PIN into the registrar. Then, when WPS is activated on the enrollee, it presents its PIN to the registrar. If the PIN matches, the registrar sends the network and security information to the enrollee, allowing it to join the network.

The advantage of using the PIN method rather than the PBC method is that you can ensure that the connection is established between the devices you specify, not just the first two devices to activate WPS in the area. However, you need to log into the configuration interfaces of both devices.

Take the following steps to set up WPS using the PIN method.

- 1 Decide which device you want to be the registrar (usually the AP) and which you want to be the enrollee (usually the client).
- 2 Look for the enrollee's WPS PIN; it may be displayed on the device. If you don't see it, log into the enrollee's configuration interface and locate the PIN. Select the PIN connection mode (not PBC connection mode). See the device's User's Guide for how to do this - for the ZyXEL Device, see [Section 6.4 on page 135](#).
- 3 Log into the configuration utility of the registrar. Select the PIN connection mode (not the PBC connection mode). Locate the place where you can enter the enrollee's PIN (if you are using the ZyXEL Device, see [Section 6.4 on page 135](#)). Enter the PIN from the enrollee device.
- 4 Activate WPS on both devices within two minutes.

Note: Use the configuration utility to activate WPS, not the push-button on the device itself.

- 5 On a computer connected to the wireless client, try to connect to the Internet. If you can connect, WPS was successful.

If you cannot connect, check the list of associated wireless clients in the AP's configuration utility. If you see the wireless client in the list, WPS was successful.

The following figure shows a WPS-enabled wireless client (installed in a notebook computer) connecting to the WPS-enabled AP via the PIN method.

Figure 199 Example WPS Process: PIN Method

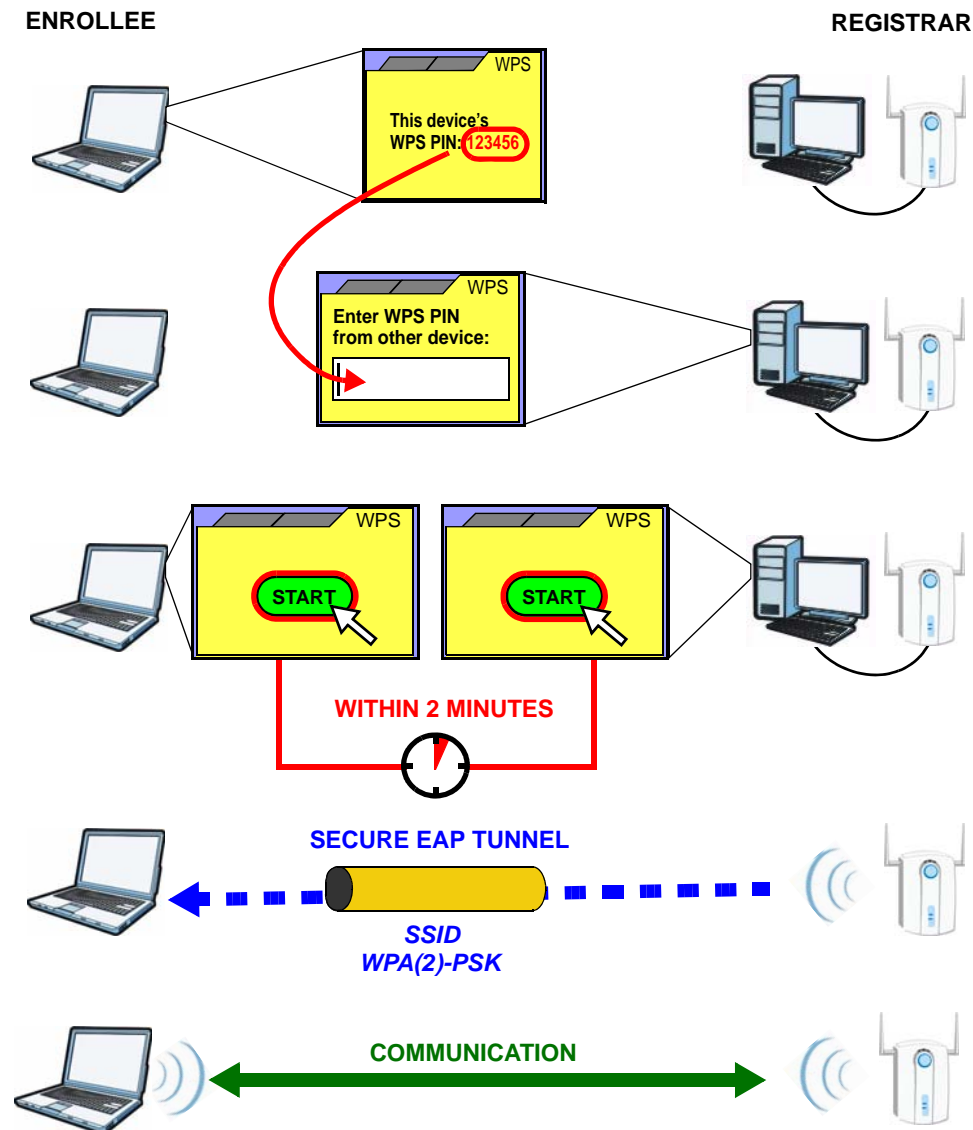

How WPS Works

When two WPS-enabled devices connect, each device must assume a specific role. One device acts as the registrar (the device that supplies network and security settings) and the other device acts as the enrollee (the device that receives network and security settings). The registrar creates a secure EAP (Extensible Authentication Protocol) tunnel and sends the network name (SSID) and the WPA-PSK or WPA2-PSK pre-shared key to the enrollee. Whether WPA-PSK or WPA2-PSK is used depends on the standards supported by the devices. If the registrar is

already part of a network, it sends the existing information. If not, it generates the SSID and WPA(2)-PSK randomly.

The following figure shows a WPS-enabled client (installed in a notebook computer) connecting to a WPS-enabled access point.

Figure 200 How WPS works

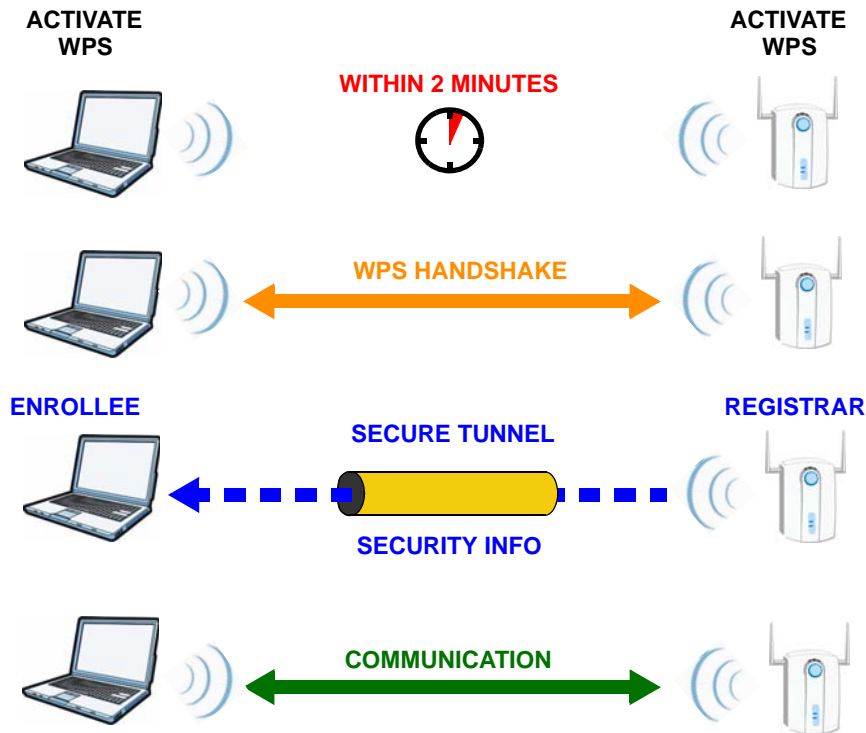

The roles of registrar and enrollee last only as long as the WPS setup process is active (two minutes). The next time you use WPS, a different device can be the registrar if necessary.

The WPS connection process is like a handshake; only two devices participate in each WPS transaction. If you want to add more devices you should repeat the process with one of the existing networked devices and the new device.

Note that the access point (AP) is not always the registrar, and the wireless client is not always the enrollee. All WPS-certified APs can be a registrar, and so can some WPS-enabled wireless clients.

By default, a WPS device is “unconfigured”. This means that it is not part of an existing network and can act as either enrollee or registrar (if it supports both functions). If the registrar is unconfigured, the security settings it transmits to the enrollee are randomly-generated. Once a WPS-enabled device has connected to another device using WPS, it becomes “configured”. A configured wireless client can still act as enrollee or registrar in subsequent WPS connections, but a configured access point can no longer act as enrollee. It will be the registrar in all

subsequent WPS connections in which it is involved. If you want a configured AP to act as an enrollee, you must reset it to its factory defaults.

Example WPS Network Setup

This section shows how security settings are distributed in an example WPS setup.

The following figure shows an example network. In step **1**, both **AP1** and **Client 1** are unconfigured. When WPS is activated on both, they perform the handshake. In this example, **AP1** is the registrar, and **Client 1** is the enrollee. The registrar randomly generates the security information to set up the network, since it is unconfigured and has no existing information.

Figure 201 WPS: Example Network Step 1

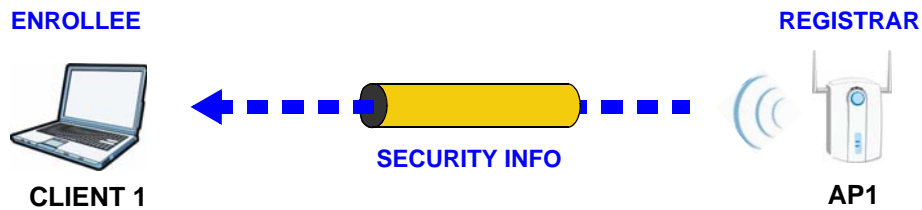

In step **2**, you add another wireless client to the network. You know that **Client 1** supports registrar mode, but it is better to use **AP1** for the WPS handshake with the new client since you must connect to the access point anyway in order to use the network. In this case, **AP1** must be the registrar, since it is configured (it already has security information for the network). **AP1** supplies the existing security information to **Client 2**.

Figure 202 WPS: Example Network Step 2

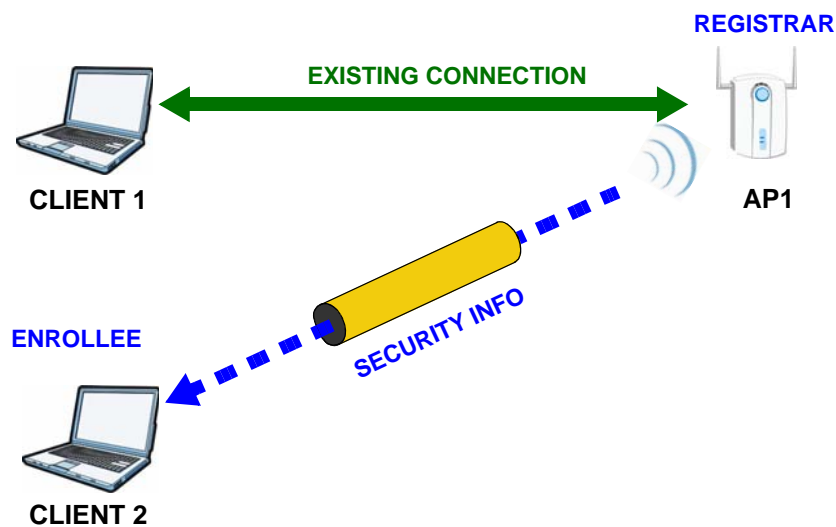

In step 3, you add another access point (**AP2**) to your network. **AP2** is out of range of **AP1**, so you cannot use **AP1** for the WPS handshake with the new access point. However, you know that **Client 2** supports the registrar function, so you use it to perform the WPS handshake instead.

Figure 203 WPS: Example Network Step 3

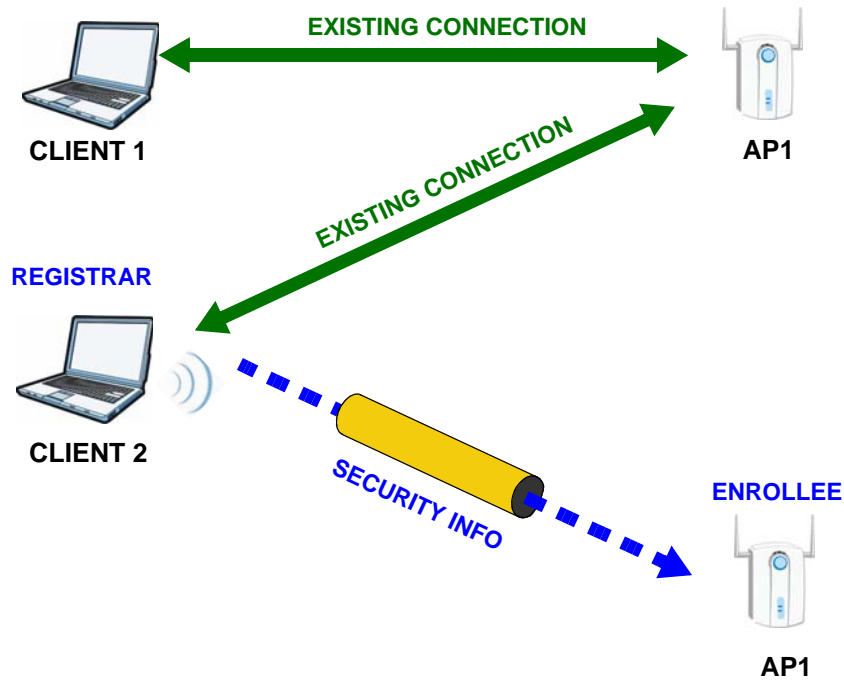

Limitations of WPS

WPS has some limitations of which you should be aware.

- WPS works in Infrastructure networks only (where an AP and a wireless client communicate). It does not work in Ad-Hoc networks (where there is no AP).
- When you use WPS, it works between two devices only. You cannot enroll multiple devices simultaneously, you must enroll one after the other.

For instance, if you have two enrollees and one registrar you must set up the first enrollee (by pressing the WPS button on the registrar and the first enrollee, for example), then check that it successfully enrolled, then set up the second device in the same way.

- WPS works only with other WPS-enabled devices. However, you can still add non-WPS devices to a network you already set up using WPS.

WPS works by automatically issuing a randomly-generated WPA-PSK or WPA2-PSK pre-shared key from the registrar device to the enrollee devices. Whether the network uses WPA-PSK or WPA2-PSK depends on the device. You can check the configuration interface of the registrar device to discover the key the network is using (if the device supports this feature). Then, you can enter the key into the non-WPS device and join the network as normal (the non-WPS device must also support WPA-PSK or WPA2-PSK).

- When you use the PBC method, there is a short period (from the moment you press the button on one device to the moment you press the button on the other device) when any WPS-enabled device could join the network. This is because the registrar has no way of identifying the “correct” enrollee, and cannot differentiate between your enrollee and a rogue device. This is a possible way for a hacker to gain access to a network.

You can easily check to see if this has happened. WPS works between only two devices simultaneously, so if another device has enrolled your device will be unable to enroll, and will not have access to the network. If this happens, open the access point’s configuration interface and look at the list of associated clients (usually displayed by MAC address). It does not matter if the access point is the WPS registrar, the enrollee, or was not involved in the WPS handshake; a rogue device must still associate with the access point to gain access to the network. Check the MAC addresses of your wireless clients (usually printed on a label on the bottom of the device). If there is an unknown MAC address you can remove it or reset the AP.

Common Services

The following table lists some commonly-used services and their associated protocols and port numbers. For a comprehensive list of port numbers, ICMP type/code numbers and services, visit the IANA (Internet Assigned Number Authority) web site.

- **Name:** This is a short, descriptive name for the service. You can use this one or create a different one, if you like.
- **Protocol:** This is the type of IP protocol used by the service. If this is **TCP/UDP**, then the service uses the same port number with TCP and UDP. If this is **USER-DEFINED**, the **Port(s)** is the IP protocol number, not the port number.
- **Port(s):** This value depends on the **Protocol**. Please refer to RFC 1700 for further information about port numbers.
 - If the **Protocol** is **TCP, UDP, or TCP/UDP**, this is the IP port number.
 - If the **Protocol** is **USER**, this is the IP protocol number.
- **Description:** This is a brief explanation of the applications that use this service or the situations in which this service is used.

Table 103 Commonly Used Services

NAME	PROTOCOL	PORT(S)	DESCRIPTION
AH (IPSEC_TUNNEL)	User-Defined	51	The IPSEC AH (Authentication Header) tunneling protocol uses this service.
AIM/New-ICQ	TCP	5190	AOL's Internet Messenger service. It is also used as a listening port by ICQ.
AUTH	TCP	113	Authentication protocol used by some servers.
BGP	TCP	179	Border Gateway Protocol.
BOOTP_CLIENT	UDP	68	DHCP Client.
BOOTP_SERVER	UDP	67	DHCP Server.
CU-SEEME	TCP UDP	7648 24032	A popular videoconferencing solution from White Pines Software.
DNS	TCP/UDP	53	Domain Name Server, a service that matches web names (for example www.zyxel.com) to IP numbers.

Table 103 Commonly Used Services (continued)

NAME	PROTOCOL	PORT(S)	DESCRIPTION
ESP (IPSEC_TUNNEL)	User-Defined	50	The IPSEC ESP (Encapsulation Security Protocol) tunneling protocol uses this service.
FINGER	TCP	79	Finger is a UNIX or Internet related command that can be used to find out if a user is logged on.
FTP	TCP TCP	20 21	File Transfer Program, a program to enable fast transfer of files, including large files that may not be possible by e-mail.
H.323	TCP	1720	NetMeeting uses this protocol.
HTTP	TCP	80	Hyper Text Transfer Protocol - a client/server protocol for the world wide web.
HTTPS	TCP	443	HTTPS is a secured http session often used in e-commerce.
ICMP	User-Defined	1	Internet Control Message Protocol is often used for diagnostic or routing purposes.
ICQ	UDP	4000	This is a popular Internet chat program.
IGMP (MULTICAST)	User-Defined	2	Internet Group Management Protocol is used when sending packets to a specific group of hosts.
IKE	UDP	500	The Internet Key Exchange algorithm is used for key distribution and management.
IRC	TCP/UDP	6667	This is another popular Internet chat program.
MSN Messenger	TCP	1863	Microsoft Networks' messenger service uses this protocol.
NEW-ICQ	TCP	5190	An Internet chat program.
NEWS	TCP	144	A protocol for news groups.
NFS	UDP	2049	Network File System - NFS is a client/server distributed file service that provides transparent file sharing for network environments.
NNTP	TCP	119	Network News Transport Protocol is the delivery mechanism for the USENET newsgroup service.
PING	User-Defined	1	Packet INTERNet Groper is a protocol that sends out ICMP echo requests to test whether or not a remote host is reachable.
POP3	TCP	110	Post Office Protocol version 3 lets a client computer get e-mail from a POP3 server through a temporary connection (TCP/IP or other).

Table 103 Commonly Used Services (continued)

NAME	PROTOCOL	PORT(S)	DESCRIPTION
PPTP	TCP	1723	Point-to-Point Tunneling Protocol enables secure transfer of data over public networks. This is the control channel.
PPTP_TUNNEL (GRE)	User-Defined	47	PPTP (Point-to-Point Tunneling Protocol) enables secure transfer of data over public networks. This is the data channel.
RCMD	TCP	512	Remote Command Service.
REAL_AUDIO	TCP	7070	A streaming audio service that enables real time sound over the web.
REXEC	TCP	514	Remote Execution Daemon.
RLOGIN	TCP	513	Remote Login.
RTELNET	TCP	107	Remote Telnet.
RTSP	TCP/UDP	554	The Real Time Streaming (media control) Protocol (RTSP) is a remote control for multimedia on the Internet.
SFTP	TCP	115	Simple File Transfer Protocol.
SMTP	TCP	25	Simple Mail Transfer Protocol is the message-exchange standard for the Internet. SMTP enables you to move messages from one e-mail server to another.
SNMP	TCP/UDP	161	Simple Network Management Program.
SNMP-TRAPS	TCP/UDP	162	Traps for use with the SNMP (RFC: 1215).
SQL-NET	TCP	1521	Structured Query Language is an interface to access data on many different types of database systems, including mainframes, midrange systems, UNIX systems and network servers.
SSH	TCP/UDP	22	Secure Shell Remote Login Program.
STRM WORKS	UDP	1558	Stream Works Protocol.
SYSLOG	UDP	514	Syslog allows you to send system logs to a UNIX server.
TACACS	UDP	49	Login Host Protocol used for (Terminal Access Controller Access Control System).
TELNET	TCP	23	Telnet is the login and terminal emulation protocol common on the Internet and in UNIX environments. It operates over TCP/IP networks. Its primary function is to allow users to log into remote host systems.

Table 103 Commonly Used Services (continued)

NAME	PROTOCOL	PORT(S)	DESCRIPTION
TFTP	UDP	69	Trivial File Transfer Protocol is an Internet file transfer protocol similar to FTP, but uses the UDP (User Datagram Protocol) rather than TCP (Transmission Control Protocol).
VDOLIVE	TCP	7000	Another videoconferencing solution.

Open Software Announcements

End-User License Agreement for “P-2612HNU-F1 and/or P-2612HNU-F3”

WARNING: ZyXEL Communications Corp. IS WILLING TO LICENSE THE SOFTWARE TO YOU ONLY UPON THE CONDITION THAT YOU ACCEPT ALL OF THE TERMS CONTAINED IN THIS LICENSE AGREEMENT. PLEASE READ THE TERMS CAREFULLY BEFORE COMPLETING THE INSTALLATION PROCESS AS INSTALLING THE SOFTWARE WILL INDICATE YOUR ASSENT TO THEM. IF YOU DO NOT AGREE TO THESE TERMS, THEN ZyXEL, IS UNWILLING TO LICENSE THE SOFTWARE TO YOU, IN WHICH EVENT YOU SHOULD RETURN THE UNINSTALLED SOFTWARE AND PACKAGING TO THE PLACE FROM WHICH IT WAS ACQUIRED OR ZyXEL, AND YOUR MONEY WILL BE REFUNDED.

1. Grant of License for Personal Use

ZyXEL Communications Corp. ("ZyXEL") grants you a non-exclusive, non-sublicense, non-transferable license to use the program with which this license is distributed (the "Software"), including any documentation files accompanying the Software ("Documentation"), for internal business use only, for up to the number of users specified in sales order and invoice. You have the right to make one backup copy of the Software and Documentation solely for archival, back-up or disaster recovery purposes. You shall not exceed the scope of the license granted hereunder. Any rights not expressly granted by ZyXEL to you are reserved by ZyXEL, and all implied licenses are disclaimed.

2. Ownership

You have no ownership rights in the Software. Rather, you have a license to use the Software as long as this License Agreement remains in full force and effect. Ownership of the Software, Documentation and all intellectual property rights therein shall remain at all times with ZyXEL. Any other use of the Software by any other entity is strictly forbidden and is a violation of this License Agreement.

3. Copyright

The Software and Documentation contain material that is protected by International Copyright Law and trade secret law, and by international treaty provisions. All rights not granted to you herein are expressly reserved by ZyXEL. You may not remove any proprietary notice of ZyXEL or any of its licensors from any copy of the Software or Documentation.

4.Restrictions

You may not publish, display, disclose, sell, rent, lease, modify, store, loan, distribute, or create derivative works of the Software, or any part thereof. You may not assign, sublicense, convey or otherwise transfer, pledge as security or otherwise encumber the rights and licenses granted hereunder with respect to the Software. Certain components of the Software, and third party open source programs included with the Software, have been or may be made available by ZyXEL listed in the below Table (collectively the "Open-Sourced Components") You may modify or replace only these Open-Sourced Components; provided that you comply with the terms of this License and any applicable licensing terms governing use of the Open-Sourced Components, which have been provided on the License Notice as below for the Software. ZyXEL is not obligated to provide any maintenance, technical or other support for the resultant modified Software. You may not copy, reverse engineer, decompile, reverse compile, translate, adapt, or disassemble the Software, or any part thereof, nor shall you attempt to create the source code from the object code for the Software. Except as and only to the extent expressly permitted in this License, by applicable licensing terms governing use of the Open-Sourced Components, or by applicable law, you may not market, co-brand, private label or otherwise permit third parties to link to the Software, or any part thereof. You may not use the Software, or any part thereof, in the operation of a service bureau or for the benefit of any other person or entity. You may not cause, assist or permit any third party to do any of the foregoing. Portions of the Software utilize or include third party software and other copyright material. Acknowledgements, licensing terms and disclaimers for such material are contained in the License Notice as below for the Software, and your use of such material is governed by their respective terms. ZyXEL has provided, as part of the Software package, access to certain third party software as a convenience. To the extent that the Software contains third party software, ZyXEL has no express or implied obligation to provide any technical or other support for such software. Please contact the appropriate software vendor or manufacturer directly for technical support and customer service related to its software and products.

5.Confidentiality

You acknowledge that the Software contains proprietary trade secrets of ZyXEL and you hereby agree to maintain the confidentiality of the Software using at least as great a degree of care as you use to maintain the confidentiality of your own most confidential information. You agree to reasonably communicate the terms and conditions of this License Agreement to those persons employed by you who come into contact with the Software, and to use reasonable best efforts to ensure

their compliance with such terms and conditions, including, without limitation, not knowingly permitting such persons to use any portion of the Software for the purpose of deriving the source code of the Software.

6.No Warranty

THE SOFTWARE IS PROVIDED "AS IS." TO THE MAXIMUM EXTENT PERMITTED BY LAW, ZyxEL DISCLAIMS ALL WARRANTIES OF ANY KIND, EITHER EXPRESSED OR IMPLIED, INCLUDING, WITHOUT LIMITATION, IMPLIED WARRANTIES OF MERCHANTABILITY AND FITNESS FOR A PARTICULAR PURPOSE. ZyxEL DOES NOT WARRANT THAT THE FUNCTIONS CONTAINED IN THE SOFTWARE WILL MEET ANY REQUIREMENTS OR NEEDS YOU MAY HAVE, OR THAT THE SOFTWARE WILL OPERATE ERROR FREE, OR IN AN UNINTERRUPTED FASHION, OR THAT ANY DEFECTS OR ERRORS IN THE SOFTWARE WILL BE CORRECTED, OR THAT THE SOFTWARE IS COMPATIBLE WITH ANY PARTICULAR PLATFORM. SOME JURISDICTIONS DO NOT ALLOW THE WAIVER OR EXCLUSION OF IMPLIED WARRANTIES SO THEY MAY NOT APPLY TO YOU. IF THIS EXCLUSION IS HELD TO BE UNENFORCEABLE BY A COURT OF COMPETENT JURISDICTION, THEN ALL EXPRESS AND IMPLIED WARRANTIES SHALL BE LIMITED IN DURATION TO A PERIOD OF THIRTY (30) DAYS FROM THE DATE OF PURCHASE OF THE SOFTWARE, AND NO WARRANTIES SHALL APPLY AFTER THAT PERIOD.

7.Limitation of Liability

IN NO EVENT WILL ZyxEL BE LIABLE TO YOU OR ANY THIRD PARTY FOR ANY INCIDENTAL OR CONSEQUENTIAL DAMAGES (INCLUDING, WITHOUT LIMITATION, INDIRECT, SPECIAL, PUNITIVE, OR EXEMPLARY DAMAGES FOR LOSS OF BUSINESS, LOSS OF PROFITS, BUSINESS INTERRUPTION, OR LOSS OF BUSINESS INFORMATION) ARISING OUT OF THE USE OF OR INABILITY TO USE THE PROGRAM, OR FOR ANY CLAIM BY ANY OTHER PARTY, EVEN IF ZyxEL HAS BEEN ADVISED OF THE POSSIBILITY OF SUCH DAMAGES. ZyxEL'S AGGREGATE LIABILITY WITH RESPECT TO ITS OBLIGATIONS UNDER THIS AGREEMENT OR OTHERWISE WITH RESPECT TO THE SOFTWARE AND DOCUMENTATION OR OTHERWISE SHALL BE EQUAL TO THE PURCHASE PRICE, BUT SHALL IN NO EVENT EXCEED THE PRODUCT'S PRICE. BECAUSE SOME STATES/COUNTRIES DO NOT ALLOW THE EXCLUSION OR LIMITATION OF LIABILITY FOR CONSEQUENTIAL OR INCIDENTAL DAMAGES, THE ABOVE LIMITATION MAY NOT APPLY TO YOU.

8.Export Restrictions

THIS LICENSE AGREEMENT IS EXPRESSLY MADE SUBJECT TO ANY APPLICABLE LAWS, REGULATIONS, ORDERS, OR OTHER RESTRICTIONS ON THE EXPORT OF THE SOFTWARE OR INFORMATION ABOUT SUCH SOFTWARE WHICH MAY BE IMPOSED FROM TIME TO TIME. YOU SHALL NOT EXPORT THE SOFTWARE, DOCUMENTATION OR INFORMATION ABOUT THE SOFTWARE AND DOCUMENTATION WITHOUT COMPLYING WITH SUCH LAWS, REGULATIONS, ORDERS, OR OTHER RESTRICTIONS. YOU AGREE TO INDEMNIFY ZyxEL AGAINST

ALL CLAIMS, LOSSES, DAMAGES, LIABILITIES, COSTS AND EXPENSES, INCLUDING REASONABLE ATTORNEYS' FEES, TO THE EXTENT SUCH CLAIMS ARISE OUT OF ANY BREACH OF THIS SECTION 8.

9. Audit Rights

ZyXEL SHALL HAVE THE RIGHT, AT ITS OWN EXPENSE, UPON REASONABLE PRIOR NOTICE, TO PERIODICALLY INSPECT AND AUDIT YOUR RECORDS TO ENSURE YOUR COMPLIANCE WITH THE TERMS AND CONDITIONS OF THIS LICENSE AGREEMENT.

10. Termination

This License Agreement is effective until it is terminated. You may terminate this License Agreement at any time by destroying or returning to ZyXEL all copies of the Software and Documentation in your possession or under your control. ZyXEL may terminate this License Agreement for any reason, including, but not limited to, if ZyXEL finds that you have violated any of the terms of this License Agreement. Upon notification of termination, you agree to destroy or return to ZyXEL all copies of the Software and Documentation and to certify in writing that all known copies, including backup copies, have been destroyed. All provisions relating to confidentiality, proprietary rights, and non-disclosure shall survive the termination of this Software License Agreement.

11. General

This License Agreement shall be construed, interpreted and governed by the laws of Republic of China without regard to conflicts of laws provisions thereof. The exclusive forum for any disputes arising out of or relating to this License Agreement shall be an appropriate court or Commercial Arbitration Association sitting in ROC, Taiwan. This License Agreement shall constitute the entire Agreement between the parties hereto. This License Agreement, the rights granted hereunder, the Software and Documentation shall not be assigned by you without the prior written consent of ZyXEL. Any waiver or modification of this License Agreement shall only be effective if it is in writing and signed by both parties hereto. If any part of this License Agreement is found invalid or unenforceable by a court of competent jurisdiction, the remainder of this License Agreement shall be interpreted so as to reasonably effect the intention of the parties.

NOTE: Some components of this product incorporate source code covered under the open source code licenses. To obtain the source code covered under those Licenses, please check ZyXEL Technical Support (support@zyxel.com.tw) to get it.

Open-Sourced Components

3RD PARTY SOFTWARE	VERSION	WEB ADDRESS OF THE SOFTWARE LICENSE TERM
MIPS Linux Kernel	2.6.20	http://www.linux-mips.org
bridge-utils	1.4	http://bridge.sourceforge.net
busybox	1.10.4	http://www.busybox.net
db	4.2.52	http://www.spikesource.com/stacklicense#sleepycat
dnsmasq	2.49	http://www.thekelleys.org.uk/dnsmasq/
dropbear	0.52	http://matt.ucc.asn.au/dropbear/dropbear.html
eatables	2.0.8-1	http://eatables.sourceforge.net
fuse	2.7.4	http://fuse.sourceforge.net
igmpproxy	0.1-beta2	http://openports.se/net/igmpproxy
iproute2	2.6.20	http://www.linuxgrill.com/anonymous/iproute2
iptables	1.3.8	http://www.netfilter.org
libbase64	0.0.1	http://www.gnu.org/software/gnulib
libedit	20080712-2.11	http://libedit.sourceforge.net
libupnp	1.4.2	http://dries.ulyssis.org/rpm/packages/libupnp/info.html
linuxigd	1	http://linux-igd.sourceforge.net
logrotate	3.7.1	http://logrotate.darwinports.com/
mini_httpd		http://www.acme.com/software/mini_httpd/
mtd-utils	1.0.0	http://www.linux-mtd.infradead.org/
ncurses	5.7	http://www.gnu.org/software/ncurses/
netatalk	2.0.3	http://liferea.sourceforge.net/
ntfs-3g	2009.4.4	http://ntfs-3g.org
openssh	5.2p1	http://www.openssh.com
p910nd	0.93	http://p910nd.sourceforge.net/
ppp	2.4.4	http://samba.org/ppp/index.html
pure-ftpd	1.0.23	http://pureftpd.org
samba	3.0.36	http://www.samba.org
syslog-ng	2.0.6	http://www.balabit.com/network-security/syslog-ng/
sysstat	8.1.8	http://pagesperso-orange.fr/sebastien.godard/

updatedd	2.6	http://www.philipp-benner.de/updatedd/
usbmount	0.0.14.1	http://usbmount.alioth.debian.org/
wireless_tools	0.29	http://www.hpl.hp.com/

Notice

Information herein is subject to change without notice. Companies, names, and data used in examples herein are fictitious unless otherwise noted. No part may be reproduced or transmitted in any form or by any means, electronic or mechanical, for any purpose, except the express written permission of ZyXEL Communications Corporation.

This Product includes Bridge-utils 1.4, Busybox 1.10.4, Dnsmasq 2.49, Ebttables 2.0.8-1, Fuse 2.7.4, Igmpproxy 0.1-beta2, Iproute2 2.6.20, Iptables 1.3.8, linuxigd 1, logrotate 3.7.1, MIPS linux kernel 2.6.20, Mtd-utils 1.0.0, Netatalk 2.0.3, Ntfs-3g 2009.4.4, P910nd 0.93, Ppp 2.4.4, Samba 3.0.36, Syslog-ng 2.0.6, Sysstat 8.1.8, Updatedd 2.6, Usbmount 0.0.14.1 and Wireless_tools 0.29 under below GPL license

GNU GENERAL PUBLIC LICENSE

Version 2, June 1991

Copyright (C) 1989, 1991 Free Software Foundation, Inc.

59 Temple Place - Suite 330, Boston, MA 02111-1307, USA

Everyone is permitted to copy and distribute verbatim copies of this license document, but changing it is not allowed.

Preamble

The licenses for most software are designed to take away your freedom to share and change it. By contrast, the GNU General Public License is intended to guarantee your freedom to share and change free software--to make sure the software is free for all its users. This General Public License applies to most of the Free Software Foundation's software and to any other program whose authors

commit to using it. (Some other Free Software Foundation software is covered by the GNU Library General Public License instead.) You can apply it to your programs, too.

When we speak of free software, we are referring to freedom, not price. Our General Public Licenses are designed to make sure that you have the freedom to distribute copies of free software (and charge for this service if you wish), that you receive source code or can get it if you want it, that you can change the software or use pieces of it in new free programs; and that you know you can do these things.

To protect your rights, we need to make restrictions that forbid anyone to deny you these rights or to ask you to surrender the rights. These restrictions translate to certain responsibilities for you if you distribute copies of the software, or if you modify it. For example, if you distribute copies of such a program, whether gratis or for a fee, you must give the recipients all the rights that you have. You must make sure that they, too, receive or can get the source code. And you must show them these terms so they know their rights.

We protect your rights with two steps: (1) copyright the software, and (2) offer you this license which gives you legal permission to copy, distribute and/or modify the software. Also, for each author's protection and ours, we want to make certain that everyone understands that there is no warranty for this free software. If the software is modified by someone else and passed on, we want its recipients to know that what they have is not the original, so that any problems introduced by others will not reflect on the original authors' reputations.

Finally, any free program is threatened constantly by software patents. We wish to avoid the danger that redistributors of a free program will individually obtain patent licenses, in effect making the program proprietary. To prevent this, we have made it clear that any patent must be licensed for everyone's free use or not licensed at all.

The precise terms and conditions for copying, distribution and modification follow.

TERMS AND CONDITIONS FOR COPYING, DISTRIBUTION AND MODIFICATION

0. This License applies to any program or other work which contains a notice placed by the copyright holder saying it may be distributed under the terms of this General Public License. The "Program", below, refers to any such program or work, and a "work based on the Program" means either the Program or any derivative work under copyright law: that is to say, a work containing the Program or a portion of it, either verbatim or with modifications and/or translated into another language. (Hereinafter, translation is included without limitation in the term "modification".) Each licensee is addressed as "you". Activities other than

copying, distribution and modification are not covered by this License; they are outside its scope. The act of running the Program is not restricted, and the output from the Program is covered only if its contents constitute a work based on the Program (independent of having been made by running the Program). Whether that is true depends on what the Program does.

1. You may copy and distribute verbatim copies of the Program's source code as you receive it, in any medium, provided that you conspicuously and appropriately publish on each copy an appropriate copyright notice and disclaimer of warranty; keep intact all the notices that refer to this License and to the absence of any warranty; and give any other recipients of the Program a copy of this License along with the Program. You may charge a fee for the physical act of transferring a copy, and you may at your option offer warranty protection in exchange for a fee.

2. You may modify your copy or copies of the Program or any portion of it, thus forming a work based on the Program, and copy and distribute such modifications or work under the terms of Section 1 above, provided that you also meet all of these conditions:

a) You must cause the modified files to carry prominent notices stating that you changed the files and the date of any change.

b) You must cause any work that you distribute or publish, that in whole or in part contains or is derived from the Program or any part thereof, to be licensed as a whole at no charge to all third parties under the terms of this License.

c) If the modified program normally reads commands interactively when run, you must cause it, when started running for such interactive use in the most ordinary way, to print or display an announcement including an appropriate copyright notice and a notice that there is no warranty (or else, saying that you provide a warranty) and that users may redistribute the program under these conditions, and telling the user how to view a copy of this License. (Exception: if the Program itself is interactive but does not normally print such an announcement, your work based on the Program is not required to print an announcement.)

These requirements apply to the modified work as a whole. If identifiable sections of that work are not derived from the Program, and can be reasonably considered independent and separate works in themselves, then this License, and its terms, do not apply to those sections when you distribute them as separate works. But when you distribute the same sections as part of a whole which is a work based on the Program, the distribution of the whole must be on the terms of this License, whose permissions for other licensees extend to the entire whole, and thus to each and every part regardless of who wrote it. Thus, it is not the intent of this section to claim rights or contest your rights to work written entirely by you; rather, the intent is to exercise the right to control the distribution of derivative or collective works based on the Program. In addition, mere aggregation of another work not based on the Program with the Program (or with a work based on the

Program) on a volume of a storage or distribution medium does not bring the other work under the scope of this License.

3. You may copy and distribute the Program (or a work based on it, under Section 2) in object code or executable form under the terms of Sections 1 and 2 above provided that you also do one of the following:

a) Accompany it with the complete corresponding machine-readable source code, which must be distributed under the terms of Sections 1 and 2 above on a medium customarily used for software interchange; or,

b) Accompany it with a written offer, valid for at least three years, to give any third party, for a charge no more than your cost of physically performing source distribution, a complete machine-readable copy of the corresponding source code, to be distributed under the terms of Sections 1 and 2 above on a medium customarily used for software interchange; or, c) Accompany it with the information you received as to the offer to distribute corresponding source code. (This alternative is allowed only for noncommercial distribution and only if you received the program in object code or executable form with such an offer, in accord with Subsection b above.) The source code for a work means the preferred form of the work for making modifications to it. For an executable work, complete source code means all the source code for all modules it contains, plus any associated interface definition files, plus the

scripts used to control compilation and installation of the executable. However, as a special exception, the source code distributed need not include anything that is normally distributed (in either source or binary form) with the major components (compiler, kernel, and so on) of the operating system on which the executable runs, unless that component itself accompanies the executable. If distribution of executable or object code is made by offering access to copy from a designated place, then offering equivalent access to copy the source code from the same place counts as distribution of the source code, even though third parties are not compelled to copy the source along with the object code.

4. You may not copy, modify, sublicense, or distribute the Program except as expressly provided under this License. Any attempt otherwise to copy, modify, sublicense or distribute the Program is void, and will automatically terminate your rights under this License. However, parties who have received copies, or rights, from you under this License will not have their licenses terminated so long as such parties remain in full compliance.

5. You are not required to accept this License, since you have not signed it. However, nothing else grants you permission to modify or distribute the Program or its derivative works. These actions are prohibited by law if you do not accept this License. Therefore, by modifying or distributing the Program (or any work based on the Program), you indicate your acceptance of this License to do so, and

all its terms and conditions for copying, distributing or modifying the Program or works based on it.

6. Each time you redistribute the Program (or any work based on the Program), the recipient automatically receives a license from the original licensor to copy, distribute or modify the Program subject to these terms and conditions. You may not impose any further restrictions on the recipients' exercise of the rights granted herein. You are not responsible for enforcing compliance by third parties to this License.

7. If, as a consequence of a court judgment or allegation of patent infringement or for any other reason (not limited to patent issues), conditions are imposed on you (whether by court order, agreement or otherwise) that contradict the conditions of this License, they do not excuse you from the conditions of this License. If you cannot distribute so as to satisfy simultaneously your obligations under this License and any other pertinent obligations, then as a consequence you may not distribute the Program at all. For example, if a patent license would not permit royalty-free redistribution of the Program by all those who receive copies directly or indirectly through you, then the only way you could satisfy both it and this License would be to refrain entirely from distribution of the Program. If any portion of this section is held invalid or unenforceable under any particular circumstance, the balance of the section is intended to apply and the section as a whole is intended to apply in other circumstances. It is not the purpose of this section to induce you to infringe any patents or other property right claims or to contest validity of any such claims; this section has the sole purpose of protecting the integrity of the free software distribution system, which is implemented by public license practices. Many people have made generous contributions to the wide range of software distributed through that system in reliance on consistent application of that system; it is up to the author/donor to decide if he or she is willing to distribute software through any other system and a licensee cannot impose that choice. This section is intended to make thoroughly clear what is believed to be a consequence of the rest of this License.

8. If the distribution and/or use of the Program is restricted in certain countries either by patents or by copyrighted interfaces, the original copyright holder who places the Program under this License may add an explicit geographical distribution limitation excluding those countries, so that distribution is permitted only in or among countries not thus excluded. In such case, this License incorporates the limitation as if written in the body of this License.

9. The Free Software Foundation may publish revised and/or new versions of the General Public License from time to time. Such new versions will be similar in spirit to the present version, but may differ in detail to address new problems or concerns. Each version is given a distinguishing version number. If the Program specifies a version number of this License which applies to it and "any later version", you have the option of following the terms and conditions either of that version or of any later version published by the Free Software Foundation. If the

Program does not specify a version number of this License, you may choose any version ever published by the Free Software Foundation.

10. If you wish to incorporate parts of the Program into other free programs whose distribution conditions are different, write to the author to ask for permission. For software which is copyrighted by the Free Software Foundation, write to the Free Software Foundation; we sometimes make exceptions for this. Our decision will be guided by the two goals of preserving the free status of all derivatives of our free software and of promoting the sharing and reuse of software generally.

NO WARRANTY

11. BECAUSE THE PROGRAM IS LICENSED FREE OF CHARGE, THERE IS NO WARRANTY FOR THE PROGRAM, TO THE EXTENT PERMITTED BY APPLICABLE LAW. EXCEPT WHEN OTHERWISE STATED IN WRITING THE COPYRIGHT HOLDERS AND/OR OTHER PARTIES PROVIDE THE PROGRAM "AS IS" WITHOUT WARRANTY OF ANY KIND, EITHER EXPRESSED OR IMPLIED, INCLUDING, BUT NOT LIMITED TO, THE IMPLIED WARRANTIES OF MERCHANTABILITY AND FITNESS FOR A PARTICULAR PURPOSE. THE ENTIRE RISK AS TO THE QUALITY AND PERFORMANCE OF THE PROGRAM IS WITH YOU. SHOULD THE PROGRAM PROVE DEFECTIVE, YOU ASSUME THE COST OF ALL NECESSARY SERVICING, REPAIR OR CORRECTION.

12. IN NO EVENT UNLESS REQUIRED BY APPLICABLE LAW OR AGREED TO IN WRITING WILL ANY COPYRIGHT HOLDER, OR ANY OTHER PARTY WHO MAY MODIFY AND/OR REDISTRIBUTE THE PROGRAM AS PERMITTED ABOVE, BE LIABLE TO YOU FOR DAMAGES, INCLUDING ANY GENERAL, SPECIAL, INCIDENTAL OR CONSEQUENTIAL DAMAGES ARISING OUT OF THE USE OR INABILITY TO USE THE PROGRAM (INCLUDING BUT NOT LIMITED TO LOSS OF DATA OR DATA BEING RENDERED INACCURATE OR LOSSES SUSTAINED BY YOU OR THIRD PARTIES OR A FAILURE OF THE PROGRAM TO OPERATE WITH ANY OTHER PROGRAMS), EVEN IF SUCH HOLDER OR OTHER PARTY HAS BEEN ADVISED OF THE POSSIBILITY OF SUCH DAMAGES.

END OF TERMS AND CONDITIONS

All other trademarks or trade names mentioned herein, if any, are the property of their respective owners.

This Product includes Dropbear 0.52 and Ncurses 5.7 under the MIT-Style License.

The MIT License

Copyright (c) <year> <copyright holders>

Permission is hereby granted, free of charge, to any person obtaining a copy of this software and associated documentation files (the "Software"), to deal in the Software without restriction, including without limitation the rights to use, copy, modify, merge, publish, distribute, sublicense, and/or sell copies of the Software, and to permit persons to whom the Software is furnished to do so, subject to the following conditions:

The above copyright notice and this permission notice shall be included in all copies or substantial portions of the Software.

THE SOFTWARE IS PROVIDED "AS IS", WITHOUT WARRANTY OF ANY KIND, EXPRESS OR IMPLIED, INCLUDING BUT NOT LIMITED TO THE WARRANTIES OF MERCHANTABILITY, FITNESS FOR A PARTICULAR PURPOSE AND NONINFRINGEMENT. IN NO EVENT SHALL THE AUTHORS OR COPYRIGHT HOLDERS BE LIABLE FOR ANY CLAIM, DAMAGES OR OTHER LIABILITY, WHETHER IN AN ACTION OF CONTRACT, TORT OR OTHERWISE, ARISING FROM, OUT OF OR IN CONNECTION WITH THE SOFTWARE OR THE USE OR OTHER DEALINGS IN THE SOFTWARE.

This Product includes libedit 20080712-2.11, libupnp 1.4.2, Openssh 5.2p1, Ppp 2.4.4 and Pure-ftpd 1.0.23 under the license by BSD

BSD

Copyright (c) [dates as appropriate to package]

The Regents of the University of California. All rights reserved. Redistribution and use in source and binary forms, with or without modification, are permitted provided that the following conditions are met:

Redistributions of source code must retain the above copyright notice, this list of conditions and the following disclaimer.

Redistributions in binary form must reproduce the above copyright notice, this list of conditions and the following disclaimer in the documentation and/or other materials provided with the distribution.

Neither the name of the University nor of the Laboratory may be used to endorse or promote products derived from this software without specific prior written permission.

THIS SOFTWARE IS PROVIDED BY THE REGENTS AND CONTRIBUTORS ``AS IS'' AND ANY EXPRESS OR IMPLIED WARRANTIES, INCLUDING, BUT NOT LIMITED TO, THE IMPLIED WARRANTIES OF MERCHANTABILITY AND FITNESS FOR A PARTICULAR PURPOSE ARE DISCLAIMED. IN NO EVENT SHALL THE REGENTS OR CONTRIBUTORS BE LIABLE FOR ANY DIRECT, INDIRECT, INCIDENTAL, SPECIAL, EXEMPLARY, OR CONSEQUENTIAL DAMAGES (INCLUDING, BUT NOT LIMITED TO, PROCUREMENT OF SUBSTITUTE GOODS OR SERVICES; LOSS OF USE, DATA, OR PROFITS; OR BUSINESS INTERRUPTION) HOWEVER CAUSED AND ON ANY THEORY OF LIABILITY, WHETHER IN CONTRACT, STRICT LIABILITY, OR TORT (INCLUDING NEGLIGENCE OR OTHERWISE) ARISING IN ANY WAY OUT OF THE USE OF THIS SOFTWARE, EVEN IF ADVISED OF THE POSSIBILITY OF SUCH DAMAGE.

This Product includes Mini_httpd under the license by ACME Labs Freeware

ACME Labs Freeware License

All the free software available on the ACME Labs web site has a copyright notice like this one:

Copyright 2000 by Jef Poskanzer <jef@mail.acme.com>. All rights reserved.

Redistribution and use in source and binary forms, with or without modification, are permitted provided that the following conditions are met:

1. Redistributions of source code must retain the above copyright notice, this list of conditions and the following disclaimer.

2. Redistributions in binary form must reproduce the above copyright notice, this list of conditions and the following disclaimer in the documentation and/or other materials provided with the distribution.

THIS SOFTWARE IS PROVIDED BY THE AUTHOR AND CONTRIBUTORS ``AS IS'' AND

ANY EXPRESS OR IMPLIED WARRANTIES, INCLUDING, BUT NOT LIMITED TO, THE IMPLIED WARRANTIES OF MERCHANTABILITY AND FITNESS FOR A PARTICULAR PURPOSE ARE DISCLAIMED. IN NO EVENT SHALL THE AUTHOR OR CONTRIBUTORS BE LIABLE FOR ANY DIRECT, INDIRECT, INCIDENTAL, SPECIAL, EXEMPLARY, OR CONSEQUENTIAL DAMAGES (INCLUDING, BUT NOT LIMITED TO, PROCUREMENT OF SUBSTITUTE GOODS OR SERVICES; LOSS OF USE, DATA, OR PROFITS; OR BUSINESS INTERRUPTION) HOWEVER CAUSED AND ON ANY THEORY OF LIABILITY, WHETHER IN CONTRACT, STRICT LIABILITY, OR TORT (INCLUDING NEGLIGENCE OR OTHERWISE) ARISING IN ANY WAY OUT OF THE USE OF THIS SOFTWARE, EVEN IF ADVISED OF THE POSSIBILITY

This Product includes libbase64 0.0.1 under the LGPL License.

GNU LESSER GENERAL PUBLIC LICENSE

Version 2.1, February 1999

Copyright (C) 1991, 1999 Free Software Foundation, Inc.

59 Temple Place, Suite 330, Boston, MA 02111-1307 USA

Everyone is permitted to copy and distribute verbatim copies of this license document, but changing it is not allowed. [This is the first released version of the Lesser GPL. It also counts as the successor of the GNU Library Public License, version 2, hence the version number 2.1.]

Preamble

The licenses for most software are designed to take away your freedom to share and change it. By contrast, the GNU General Public Licenses are intended to guarantee your freedom to share and change free software--to make sure the software is free for all its users.

This license, the Lesser General Public License, applies to some specially designated software packages--typically libraries--of the Free Software Foundation and other authors who decide to use it. You can use it too, but we suggest you first think carefully about whether this license or the ordinary General Public License is the better strategy to use in any particular case, based on the explanations below.

When we speak of free software, we are referring to freedom of use, not price. Our General Public Licenses are designed to make sure that you have the freedom to distribute copies of free software (and charge for this service if you wish); that you receive source code or can get it if you want it; that you can change the software and use pieces of it in new free programs; and that you are informed that you can do these things.

To protect your rights, we need to make restrictions that forbid distributors to deny you these rights or to ask you to surrender these rights. These restrictions translate to certain responsibilities for you if you distribute copies of the library or if you modify it.

For example, if you distribute copies of the library, whether gratis or for a fee, you must give the recipients all the rights that we gave you. You must make sure that they, too, receive or can get the source code. If you link other code with the library, you must provide complete object files to the recipients, so that they can relink them with the library after making changes to the library and recompiling it. And you must show them these terms so they know their rights.

We protect your rights with a two-step method: (1) we copyright the library, and (2) we offer you this license, which gives you legal permission to copy, distribute and/or modify the library.

To protect each distributor, we want to make it very clear that there is no warranty for the free library. Also, if the library is modified by someone else and passed on, the recipients should know that what they have is not the original version, so that the original author's reputation will not be affected by problems that might be introduced by others.

Finally, software patents pose a constant threat to the existence of any free program. We wish to make sure that a company cannot effectively restrict the

users of a free program by obtaining a restrictive license from a patent holder. Therefore, we insist that any patent license obtained for a version of the library must be consistent with the full freedom of use specified in this license.

Most GNU software, including some libraries, is covered by the ordinary GNU General Public License. This license, the GNU Lesser General Public License, applies to certain designated libraries, and is quite different from the ordinary General Public License. We use this license for certain libraries in order to permit linking those libraries into non-free programs.

When a program is linked with a library, whether statically or using a shared library, the combination of the two is legally speaking a combined work, a derivative of the original library. The ordinary General Public License therefore permits such linking only if the entire combination fits its criteria of freedom. The Lesser General Public License permits more lax criteria for linking other code with the library.

We call this license the "Lesser" General Public License because it does Less to protect the user's freedom than the ordinary General Public License. It also provides other free software developers Less of an advantage over competing non-free programs. These disadvantages are the reason we use the ordinary General Public License for many libraries. However, the Lesser license provides advantages in certain special circumstances.

For example, on rare occasions, there may be a special need to encourage the widest possible use of a certain library, so that it becomes a de-facto standard. To achieve this, non-free programs must be allowed to use the library. A more frequent case is that a free library does the same job as widely used non-free libraries. In this case, there is little to gain by limiting the free library to free software only, so we use the Lesser General Public License. In other cases, permission to use a particular library in non-free programs enables a greater number of people to use a large body of free software. For example, permission to use the GNU C Library in non-free programs enables many more people to use the whole GNU operating system, as well as its variant, the GNU/Linux operating system.

Although the Lesser General Public License is Less protective of the users' freedom, it does ensure that the user of a program that is linked with the Library has the freedom and the wherewithal to run that program using a modified version of the Library.

The precise terms and conditions for copying, distribution and modification follow. Pay close attention to the difference between a "work based on the library" and a "work that uses the library". The former contains code derived from the library, whereas the latter must be combined with the library in order to run.

GNU LESSER GENERAL PUBLIC LICENSE TERMS AND CONDITIONS FOR COPYING, DISTRIBUTION AND MODIFICATION

0. This License Agreement applies to any software library or other program which contains a notice placed by the copyright holder or other authorized party saying it may be distributed under the terms of this Lesser General Public License (also called "this License").

Each licensee is addressed as "you".

A "library" means a collection of software functions and/or data prepared so as to be conveniently linked with application programs (which use some of those functions and data) to form executables. The "Library", below, refers to any such software library or work which has been distributed under these terms. A "work based on the Library" means either the Library or any derivative work under copyright law: that is to say, a work containing the Library or a portion of it, either verbatim or with modifications and/or translated straightforwardly into another language. (Hereinafter, translation is included without limitation in the term "modification".)

"Source code" for a work means the preferred form of the work for making modifications to it. For a library, complete source code means all the source code for all modules it contains, plus any associated interface definition files, plus the scripts used to control compilation and installation of the library. Activities other than copying, distribution and modification are not covered by this License; they are outside its scope. The act of running a program using the Library is not restricted, and output from such a program is covered only if its contents constitute a work based on the Library (independent of the use of the Library in a tool for writing it). Whether that is true depends on what the Library does and what the program that uses the Library does.

1. You may copy and distribute verbatim copies of the Library's complete source code as you receive it, in any medium, provided that you conspicuously and appropriately publish on each copy an appropriate copyright notice and disclaimer of warranty; keep intact all the notices that refer to this License and to the absence of any warranty; and distribute a copy of this License along with the Library. You may charge a fee for the physical act of transferring a copy, and you may at your option offer warranty protection in exchange for a fee.

2. You may modify your copy or copies of the Library or any portion of it, thus forming a work based on the Library, and copy and distribute such modifications or work under the terms of Section 1 above, provided that you also meet all of these conditions: a) The modified work must itself be a software library. b) You must cause the files modified to carry prominent notices stating that you changed the files and the date of any change. c) You must cause the whole of the work to be licensed at no charge to all third parties under the terms of this License. d) If a facility in the modified Library refers to a function or a table of data to be supplied

by an application program that uses the facility, other than as an argument passed when the facility is invoked, then you must make a good faith effort to ensure that, in the event an application does not supply such function or table, the facility still operates, and performs whatever part of its purpose remains meaningful. (For example, a function in a library to compute square roots has a purpose that is entirely well-defined independent of the application. Therefore, Subsection 2d requires that any application-supplied function or table used by this function must be optional: if the application does not supply it, the square root function must still compute square roots.) These requirements apply to the modified work as a whole. If identifiable sections of that work are not derived from the Library, and can be reasonably considered independent and separate works in themselves, then this License, and its terms, do not apply to those sections when you distribute them as separate works. But when you distribute the same sections as part of a whole which is a work based on the Library, the distribution of the whole must be on the terms of this License, whose permissions for other licensees extend to the entire whole, and thus to each and every part regardless of who wrote it. Thus, it is not the intent of this section to claim rights or contest your rights to work written entirely by you; rather, the intent is to exercise the right to control the distribution of derivative or collective works based on the Library. In addition, mere aggregation of another work not based on the Library with the Library (or with a work based on the Library) on a volume of a storage or distribution medium does not bring the other work under the scope of this License.

3. You may opt to apply the terms of the ordinary GNU General Public License instead of this License to a given copy of the Library. To do this, you must alter all the notices that refer to this License, so that they refer to the ordinary GNU General Public License, version 2, instead of to this License. (If a newer version than version 2 of the ordinary GNU General Public License has appeared, then you can specify that version instead if you wish.) Do not make any other change in these notices. Once this change is made in a given copy, it is irreversible for that copy, so the ordinary GNU General Public License applies to all subsequent copies and derivative works made from that copy. This option is useful when you wish to copy part of the code of the Library into a program that is not a library.

4. You may copy and distribute the Library (or a portion or derivative of it, under Section 2) in object code or executable form under the terms of Sections 1 and 2 above provided that you accompany it with the complete corresponding machine-readable source code, which must be distributed under the terms of Sections 1 and 2 above on a medium customarily used for software interchange. If distribution of object code is made by offering access to copy from a designated place, then offering equivalent access to copy the source code from the same place satisfies the requirement to distribute the source code, even though third parties are not compelled to copy the source along with the object code.

5. A program that contains no derivative of any portion of the Library, but is designed to work with the Library by being compiled or linked with it, is called a

"work that uses the Library". Such a work, in isolation, is not a derivative work of the Library, and therefore falls outside the scope of this License.

However, linking a "work that uses the Library" with the Library creates an executable that is a derivative of the Library (because it contains portions of the Library), rather than a "work that uses the library". The executable is therefore covered by this License. Section 6 states terms for distribution of such executables. When a "work that uses the Library" uses material from a header file that is part of the Library, the object code for the work may be a derivative work of the Library even though the source code is not. Whether this is true is especially significant if the work can be linked without the Library, or if the work is itself a library. The threshold for this to be true is not precisely defined by law. If such an object file uses only numerical parameters, data structure layouts and accessors, and small macros and small inline functions (ten lines or less in length), then the use of the object file is unrestricted, regardless of whether it is legally a derivative work. (Executables containing this object code plus portions of the Library will still fall under Section 6.) Otherwise, if the work is a derivative of the Library, you may distribute the object code for the work under the terms of Section 6. Any executables containing that work also fall under Section 6, whether or not they are linked directly with the Library itself.

6. As an exception to the Sections above, you may also combine or link a "work that uses the Library" with the Library to produce a work containing portions of the Library, and distribute that work under terms of your choice, provided that the terms permit modification of the work for the customer's own use and reverse engineering for debugging such modifications. You must give prominent notice with each copy of the work that the Library is used in it and that the Library and its use are covered by this License. You must supply a copy of this License. If the work during execution displays copyright notices, you must include the copyright notice for the Library among them, as well as a reference directing the user to the copy of this License. Also, you must do one of these things: a) Accompany the work with the complete corresponding machine-readable source code for the Library including whatever changes were used in the work (which must be distributed under Sections 1 and 2 above); and, if the work is an executable linked with the Library, with the complete machine-readable "work that uses the Library", as object code and/or source code, so that the user can modify the Library and then relink to produce a modified executable containing the modified Library. (It is understood that the user who changes the contents of definitions files in the Library will not necessarily be able to recompile the application to use the modified definitions.) b) Use a suitable shared library mechanism for linking with the Library. A suitable mechanism is one that (1) uses at run time a copy of the library already present on the user's computer system, rather than copying library functions into the executable, and (2) will operate properly with a modified version of the library, if the user installs one, as long as the modified version is interface-compatible with the version that the work was made with. c) Accompany the work with a written offer, valid for at least three years, to give the same user

the materials specified in Subsection 6a, above, for a charge no more than the cost of performing this distribution. d) If distribution of the work is made by offering access to copy from a designated place, offer equivalent access to copy the above specified materials from the same place. e) Verify that the user has already received a copy of these materials or that you have already sent this user a copy. For an executable, the required form of the "work that uses the Library" must include any data and utility programs needed for reproducing the executable from it. However, as a special exception, the materials to be distributed need not include anything that is normally distributed (in either source or binary form) with the major components (compiler, kernel, and so on) of the operating system on which the executable runs, unless that component itself accompanies the executable.

It may happen that this requirement contradicts the license restrictions of other proprietary libraries that do not normally accompany the operating system. Such a contradiction means you cannot use both them and the Library together in an executable that you distribute.

7. You may place library facilities that are a work based on the Library side-by-side in a single library together with other library facilities not covered by this License, and distribute such a combined library, provided that the separate distribution of the work based on the Library and of the other library facilities is otherwise permitted, and provided that you do these two things: a) Accompany the combined library with a copy of the same work based on the Library, uncombined with any other library facilities. This must be distributed under the terms of the Sections above. b) Give prominent notice with the combined library of the fact that part of it is a work based on the Library, and explaining where to find the accompanying uncombined form of the same work.

8. You may not copy, modify, sublicense, link with, or distribute the Library except as expressly provided under this License. Any attempt otherwise to copy, modify, sublicense, link with, or distribute the Library is void, and will automatically terminate your rights under this License. However, parties who have received copies, or rights, from you under this License will not have their licenses terminated so long as such parties remain in full compliance.

9. You are not required to accept this License, since you have not signed it. However, nothing else grants you permission to modify or distribute the Library or its derivative works. These actions are prohibited by law if you do not accept this License. Therefore, by modifying or distributing the Library (or any work based on the Library), you indicate your acceptance of this License to do so, and all its terms and conditions for copying, distributing or modifying the Library or works based on it.

10. Each time you redistribute the Library (or any work based on the Library), the recipient automatically receives a license from the original licensor to copy, distribute, link with or modify the Library subject to these terms and conditions.

You may not impose any further restrictions on the recipients' exercise of the rights granted herein. You are not responsible for enforcing compliance by third parties with this License.

11. If, as a consequence of a court judgment or allegation of patent infringement or for any other reason (not limited to patent issues), conditions are imposed on you (whether by court order, agreement or otherwise) that contradict the conditions of this License, they do not excuse you from the conditions of this License. If you cannot distribute so as to satisfy simultaneously your obligations under this License and any other pertinent obligations, then as a consequence you may not distribute the Library at all. For example, if a patent license would not permit royalty-free redistribution of the Library by all those who receive copies directly or indirectly through you, then the only way you could satisfy both it and this License would be to refrain entirely from distribution of the Library. If any portion of this section is held invalid or unenforceable under any particular circumstance, the balance of the section is intended to apply, and the section as a whole is intended to apply in other circumstances. It is not the purpose of this section to induce you to infringe any patents or other property right claims or to contest validity of any such claims; this section has the sole purpose of protecting the integrity of the free software distribution system which is implemented by public license practices. Many people have made generous contributions to the wide range of software distributed through that system in reliance on consistent application of that system; it is up to the author/donor to decide if he or she is willing to distribute software through any other system and a licensee cannot impose that choice. This section is intended to make thoroughly clear what is believed to be a consequence of the rest of this License.

12. If the distribution and/or use of the Library is restricted in certain countries either by patents or by copyrighted interfaces, the original copyright holder who places the Library under this License may add an explicit geographical distribution limitation excluding those countries, so that distribution is permitted only in or among countries not thus excluded. In such case, this License incorporates the limitation as if written in the body of this License.

13. The Free Software Foundation may publish revised and/or new versions of the Lesser General Public License from time to time. Such new versions will be similar in spirit to the present version, but may differ in detail to address new problems or concerns. Each version is given a distinguishing version number. If the Library specifies a version number of this License which applies to it and "any later version", you have the option of following the terms and conditions either of that version or of any later version published by the Free Software Foundation. If the Library does not specify a license version number, you may choose any version ever published by the Free Software Foundation.

14. If you wish to incorporate parts of the Library into other free programs whose distribution conditions are incompatible with these, write to the author to ask for permission. For software which is copyrighted by the Free Software Foundation,

write to the Free Software Foundation; we sometimes make exceptions for this. Our decision will be guided by the two goals of preserving the free status of all derivatives of our free software and of promoting the sharing and reuse of software generally.

NO WARRANTY

15. BECAUSE THE LIBRARY IS LICENSED FREE OF CHARGE, THERE IS NO WARRANTY FOR THE LIBRARY, TO THE EXTENT PERMITTED BY APPLICABLE LAW. EXCEPT WHEN OTHERWISE STATED IN WRITING THE COPYRIGHT HOLDERS AND/OR OTHER PARTIES PROVIDE THE LIBRARY "AS IS" WITHOUT WARRANTY OF ANY KIND, EITHER EXPRESSED OR IMPLIED, INCLUDING, BUT NOT LIMITED TO, THE IMPLIED WARRANTIES OF MERCHANTABILITY AND FITNESS FOR A PARTICULAR PURPOSE. THE ENTIRE RISK AS TO THE QUALITY AND PERFORMANCE OF THE LIBRARY IS WITH YOU. SHOULD THE LIBRARY PROVE DEFECTIVE, YOU ASSUME THE COST OF ALL NECESSARY SERVICING, REPAIR OR CORRECTION.

16. IN NO EVENT UNLESS REQUIRED BY APPLICABLE LAW OR AGREED TO IN WRITING WILL ANY COPYRIGHT HOLDER, OR ANY OTHER PARTY WHO MAY MODIFY AND/OR REDISTRIBUTE THE LIBRARY AS PERMITTED ABOVE, BE LIABLE TO YOU FOR DAMAGES, INCLUDING ANY GENERAL, SPECIAL, INCIDENTAL OR CONSEQUENTIAL DAMAGES ARISING OUT OF THE USE OR INABILITY TO USE THE LIBRARY (INCLUDING BUT NOT LIMITED TO LOSS OF DATA OR DATA BEING RENDERED INACCURATE OR LOSSES SUSTAINED BY YOU OR THIRD PARTIES OR A FAILURE OF THE LIBRARY TO OPERATE WITH ANY OTHER SOFTWARE), EVEN IF SUCH HOLDER OR OTHER PARTY HAS BEEN ADVISED OF THE POSSIBILITY OF SUCH DAMAGES.

END OF TERMS AND CONDITIONS.

This Product includes Db under the 4.2.52 License.

Oracle BerkelyDB

This open source database delivers the core data management functionality, power, scalability and flexibility of enterprise relational databases, but without the overhead of a query processing layer. It is available under the Open Source License for Oracle BerkelyDB. The license permits you to use the software at no charge under the condition that if you use the software in an application you

redistribute, the complete source code for your application must be available and freely redistributable under reasonable conditions. If you do not want to release the source code or your application, you may wish to obtain a separate commercial license for this component directly from Oracle.

Legal Information

Copyright

Copyright © 2010 by ZyXEL Communications Corporation.

The contents of this publication may not be reproduced in any part or as a whole, transcribed, stored in a retrieval system, translated into any language, or transmitted in any form or by any means, electronic, mechanical, magnetic, optical, chemical, photocopying, manual, or otherwise, without the prior written permission of ZyXEL Communications Corporation.

Published by ZyXEL Communications Corporation. All rights reserved.

Disclaimer

ZyXEL does not assume any liability arising out of the application or use of any products, or software described herein. Neither does it convey any license under its patent rights nor the patent rights of others. ZyXEL further reserves the right to make changes in any products described herein without notice. This publication is subject to change without notice.

Your use of the ZyXEL Device is subject to the terms and conditions of any related service providers.

Certifications

Notices

Changes or modifications not expressly approved by the party responsible for compliance could void the user's authority to operate the equipment.

This device has been designed for the WLAN 2.4 GHz network throughout the EC region and Switzerland, with restrictions in France.

Viewing Certifications

- 1 Go to <http://www.zyxel.com>.
- 2 Select your product on the ZyXEL home page to go to that product's page.
- 3 Select the certification you wish to view from this page.

ZyXEL Limited Warranty

ZyXEL warrants to the original end user (purchaser) that this product is free from any defects in materials or workmanship for a period of up to two years from the date of purchase. During the warranty period, and upon proof of purchase, should the product have indications of failure due to faulty workmanship and/or materials, ZyXEL will, at its discretion, repair or replace the defective products or components without charge for either parts or labor, and to whatever extent it shall deem necessary to restore the product or components to proper operating condition. Any replacement will consist of a new or re-manufactured functionally equivalent product of equal or higher value, and will be solely at the discretion of ZyXEL. This warranty shall not apply if the product has been modified, misused, tampered with, damaged by an act of God, or subjected to abnormal working conditions.

Note

Repair or replacement, as provided under this warranty, is the exclusive remedy of the purchaser. This warranty is in lieu of all other warranties, express or implied, including any implied warranty of merchantability or fitness for a particular use or purpose. ZyXEL shall in no event be held liable for indirect or consequential damages of any kind to the purchaser.

To obtain the services of this warranty, contact your vendor. You may also refer to the warranty policy for the region in which you bought the device at http://www.zyxel.com/web/support_warranty_info.php.

Registration

Register your product online to receive e-mail notices of firmware upgrades and information at www.zyxel.com.

Index

A

- AAL5 [312](#)
- ACK message [250](#)
- activation
 - media server [162](#)
 - SSID [132](#)
 - wireless LAN
 - scheduling [137](#)
- adding a printer example [66](#)
- administrator password [30](#)
- ADSL2 [312](#)
- Advanced Encryption Standard, see AES
- AES [383](#)
- ALG [316](#)
- alternative subnet mask notation [324](#)
- antenna [309](#)
 - directional [388](#)
 - gain [387](#)
 - omni-directional [388](#)
- AP (Access Point) [375](#)
- Application Layer Gateway [316](#)
- applications
 - Internet access [22](#)
 - media server [161](#)
 - activation [162](#)
 - iTunes server [161](#)
 - VoIP [23](#)
- Asynchronous Transfer Mode [297](#)
- ATM Adaptation Layer 5, see AAL5
- audience [3](#)
- authentication [138, 140](#)
 - RADIUS server [140](#)
- auto dial [314](#)
- automatic logout [30](#)
- auto-negotiating rate adaptation [312](#)

B

- backup
 - configuration [291](#)
- bandwidth management [187](#)
- Basic Service Set, see BSS
- blinking LEDs [26](#)
- Broadband [93](#)
- broadcast [117](#)
- BSS [141, 373](#)
 - example [142](#)
- BYE request [250](#)

C

- CA [219, 381](#)
- call forwarding [315](#)
- call hold [254](#)
- call park and pickup [314](#)
- call return [314](#)
- call rule [243](#)
- call service mode [253](#)
- call transfer [254](#)
- call waiting [254, 314](#)
- caller ID [315](#)
- Canonical Format Indicator See CFI
- CBR (Constant Bit Rate) [100, 105, 108](#)
- certificate
 - factory default [223](#)
- Certificate Authority, see CA
- certificates [219](#)
 - CA [219](#)
 - replacing [223](#)
 - storage space [223](#)
 - thumbprint algorithms [222](#)
 - thumbprints [222](#)
 - trusted CAs [224, 225](#)
 - verifying fingerprints [221](#)
- Certification Authority, see CA

certifications [425](#)
 notices [425](#)
 viewing [426](#)
CFI [117](#)
channel [375](#)
 interference [375](#)
channel scan [125](#)
channel, wireless LAN [123](#)
Class of Service [251](#)
Class of Service, see CoS
client list [156](#)
client-server protocol [247](#)
codecs [316](#)
comfort noise generation [228](#), [315](#)
command interface [25](#)
configuration [164](#)
 backup [291](#)
 reset [293](#)
 restoring [292](#)
copyright [425](#)
CoS [198](#), [251](#)
country code [314](#)
CTS (Clear to Send) [376](#)
CTS threshold [138](#)

D

data fragment threshold [138](#)
default LAN IP address [29](#)
Denial of Service, see DoS
device management
 command interface [25](#)
 Telnet [25](#)
DHCP [90](#), [152](#), [164](#), [165](#), [209](#)
DHCP relay [310](#)
DHCP server [310](#)
diagnostic [295](#)
differentiated services [252](#)
Differentiated Services, see DiffServ
DiffServ (Differentiated Services) [251](#)
 code points [251](#)
 marking rule [199](#), [252](#)
disclaimer [425](#)

DLNA [161](#)
DnD [314](#)
DNS [152](#), [183](#)
DNS server address assignment [117](#)
Do not Disturb, see DnD
domain name system, see DNS
Domain Name System. See DNS.
DS (Differentiated Services) [198](#)
DS field [198](#), [252](#)
DSCP [198](#), [251](#)
DSL line, reinitialize [298](#)
DTMF [251](#)
 detection and generation [316](#)
Dual-Tone MultiFrequency, see DTMF
dynamic DNS [209](#)
Dynamic Host Configuration Protocol, see DHCP
dynamic jitter buffer [315](#)
dynamic WEP key exchange [382](#)
DYNDNS wildcard [209](#)

E

EAP Authentication [380](#)
echo cancellation [229](#), [315](#)
Encapsulation [113](#)
 MER [113](#)
 PPP over Ethernet [113](#)
encapsulation [95](#)
 RFC 1483 [113](#)
encryption [140](#), [383](#)
ESS [374](#)
Europe type call service mode [253](#)
Extended Service Set IDentification [124](#), [133](#)
Extended Service Set, see ESS
external antenna [316](#)
external RADIUS [317](#)

F

F4/F5 OAM [312](#)
File Sharing [159](#)
file sharing [24](#)

filters
 MAC address [139](#)
 firewalls [211](#)
 configuration [213](#)
 security [215](#)
 firmware [289](#)
 flash key [253](#)
 flashing [253](#)
 fragmentation threshold [138, 377](#)
 frequency range [317](#)
 FTP [202](#)

G

G.168 [229, 315](#)
 G.711 [316](#)
 G.729 [316](#)
 G.992.1 [312](#)
 G.992.3 [312](#)
 G.992.5 [312](#)

H

hidden node [375](#)
 host [265](#)
 host name [89](#)
 humidity [309](#)

I

IAD [21](#)
 IANA [166, 330](#)
 IBSS [373](#)
 IEEE 802.11g [377](#)
 IEEE 802.11g wireless LAN [316](#)
 IEEE 802.11i [316](#)
 IEEE 802.1Q [116](#)
 IEEE 802.1Q VLAN [252](#)
 IGMP [117](#)
 version [117](#)

IGMP proxy [313](#)
 IGMP v1 [313](#)
 IGMP v2 [313](#)
 importing trusted CAs [225](#)
 Independent Basic Service Set, see IBSS
 initialization vector (IV) [383](#)
 install UPnP [168](#)
 Windows Me [168](#)
 Windows XP [170](#)
 Integrated Access Device, see IAD
 intended audience [3](#)
 Internet access [22](#)
 Internet Assigned Numbers Authority
 See IANA
 Internet Assigned Numbers Authority, see IANA
 Internet Service Provider, see ISP
 IP address [90, 165](#)
 default [29](#)
 ping [295](#)
 WAN [95](#)
 IP Address Assignment [116](#)
 IP multicasting [313](#)
 IP pool [156](#)
 IP pool setup [165](#)
 ISP [95](#)
 iTunes server [161](#)
 ITU-T [229](#)
 ITU-T G.992.1 [298](#)

J

jitter buffer [315](#)

L

LAN [151](#)
 and USB printer [163](#)
 client list [156](#)
 MAC address [157](#)
 LAN TCP/IP [165](#)
 limitations
 wireless LAN [141](#)

- WPS [148](#)
- listening port [232](#)
- Local Area Network, see LAN
- login
 - passwords [30](#)
- logout [30](#)
 - automatic [30](#)
- logs [257](#), [261](#), [277](#)

M

- MAC [89](#), [217](#)
- MAC address [157](#)
 - filter [139](#)
- MAC address filtering [217](#)
- MAC filter [217](#)
- managing the device
 - command interface [25](#)
 - good habits [26](#)
 - Telnet [25](#)
 - using FTP. See FTP.
- Maximum Burst Size (MBS) [100](#), [105](#), [109](#), [114](#)
- MBSSID [142](#)
- Media access control [217](#)
- Media Access Control, see MAC Address
- media server [161](#)
 - activation [162](#)
 - iTunes server [161](#)
- Message Integrity Check, see MIC
- MIC [383](#)
- model name [89](#)
- MTU (Multi-Tenant Unit) [116](#)
- multicast [117](#)
- multimedia [245](#)
- Multiple BSS, see MBSSID
- multiple PVC support [311](#)
- multiple SIP accounts [315](#)
- multiple voice channels [315](#)
- multiplexing [114](#)
 - LLC-based [114](#)
 - VC-based [114](#)
- multiprotocol encapsulation [113](#)

N

- NAT [165](#), [203](#), [329](#)
 - definitions [206](#)
 - how it works [207](#)
 - what it does [207](#)
- Network Address Translation, see NAT
- network map [33](#)
- non-proxy calls [243](#)

O

- OAM [312](#)
- OK response [250](#)
- operation humidity [309](#)
- operation temperature [309](#)

P

- Pairwise Master Key (PMK) [383](#), [385](#)
- park [314](#)
- passphrase [127](#)
- passwords [30](#)
- PBC [143](#)
- Peak Cell Rate (PCR) [100](#), [105](#), [108](#), [114](#)
- peer-to-peer calls [243](#)
- Per-Hop Behavior, see PHB
- PHB [199](#), [252](#)
- phone book
 - speed dial [243](#)
- phone config [314](#)
- pickup [314](#)
- PIN, WPS [144](#)
 - example [145](#)
- point-to-point calls [316](#)
- ports [26](#)
- power adaptor [317](#)
- power specifications [309](#)
- PPP (Point-to-Point Protocol) Link Layer Protocol [313](#)
- PPP over ATM AAL5 [312](#)
- PPP over Ethernet [312](#)

PPP over Ethernet, see PPPoE
 PPPoE [95](#), [113](#), [311](#)
 Benefits [113](#)
 preamble [138](#)
 preamble mode [377](#)
 print server [24](#)
 Printer Server [163](#)
 printer sharing
 and LAN [163](#)
 configuration [61](#)
 requirements [163](#)
 TCP/IP port [61](#)
 product registration [426](#)
 profile [45](#)
 protocol [95](#)
 PSK [383](#)
 PSTN call setup signaling [251](#)
 pulse dialing [251](#)
 Push Button Configuration, see PBC
 push button, WPS [143](#)

Q

QoS [187](#), [188](#), [198](#), [251](#), [315](#)
 Quality of Service [315](#)
 Quality of Service, see QoS
 quick dialing [316](#)
 Quick Start Guide [29](#)

R

RADIUS [317](#), [379](#)
 message types [379](#)
 messages [379](#)
 shared secret key [380](#)
 RADIUS server [140](#)
 Reach-Extended ADSL [312](#)
 Real time Transport Protocol, see RTP
 region [314](#)
 registration
 product [426](#)
 reinitialize the ADSL line [298](#)

related documentation [3](#)
 REN [315](#)
 Request To Send, see RTS
 reset [293](#)
 RESET button [28](#)
 restart [293](#)
 restoring configuration [292](#)
 RFC 1483 [113](#), [312](#)
 RFC 1631 [201](#)
 RFC 1889 [249](#), [316](#)
 RFC 1890 [316](#)
 RFC 2327 [316](#)
 RFC 2364 [312](#)
 RFC 2516 [311](#), [312](#)
 RFC 2684 [312](#)
 RFC 3261 [316](#)
 Ringer Equivalence Number, see REN
 router features [22](#)
 RTCP [316](#)
 RTP [249](#), [316](#)
 RTS (Request To Send) [376](#)
 threshold [375](#), [376](#)
 RTS threshold [138](#)

S

safety warnings [7](#)
 scan [125](#)
 scheduling
 wireless LAN [137](#)
 SDP [316](#)
 seamless rate adaptation [312](#)
 security
 wireless LAN [138](#)
 security, network [215](#)
 service access control [270](#)
 Service Set [124](#), [133](#)
 Session Description Protocol [316](#)
 Session Initiation Protocol, see SIP
 silence suppression [228](#), [315](#)
 SIP [245](#)
 account [245](#)
 accounts [315](#)

- ALG [316](#)
- Application Layer Gateway [316](#)
- call progression [249](#)
- client [247](#)
- identities [245](#)
- INVITE request [250](#)
- number [246](#)
- proxy server [247](#)
- redirect server [248](#)
- register server [249](#)
- servers [247](#)
- service domain [246](#)
- URI [245](#)
- user agent [247](#)
- version 2 [316](#)
- SMTP error messages [278](#)
- SNMP [313](#)
- speed dial [243](#)
- SRA [312](#)
- SSID [139](#)
 - activation [132](#)
 - MBSSID [142](#)
- stateful inspection [311](#)
- static route [179](#)
- static VLAN
- status [87](#)
- status indicators [26](#)
- storage humidity [309](#)
- storage temperature [309](#)
- subnet [321](#)
- subnet mask [165](#), [322](#)
- subnetting [324](#)
- supplementary services [252](#)
- Sustain Cell Rate (SCR) [100](#), [105](#), [109](#)
- Sustained Cell Rate (SCR) [114](#)
- syntax conventions [5](#)
- system
 - firmware [289](#)
 - passwords [30](#)
 - status [87](#)
- System Info [89](#)
- system name [89](#), [272](#)

T

- Tag Control Information See TCI
- Tag Protocol Identifier See TPID
- TCI
- TCP/IP port [61](#)
- Telnet [25](#)
- temperature [309](#)
- Temporal Key Integrity Protocol, see TKIP
- The [95](#)
- three-way conference [254](#)
- thresholds
 - data fragment [138](#)
 - RTS/CTS [138](#)
- TKIP [383](#)
- ToS [251](#)
- TPID [116](#)
- traffic shaping [114](#)
- transparent bridging [313](#)
- trusted CAs, and certificates [224](#)
- tutorial
 - VoIP [51](#)
 - wireless [40](#)
- Type of Service, see ToS

U

- unicast [117](#)
- Uniform Resource Identifier [245](#)
- Universal Plug and Play, see UPnP
- upgrading firmware [289](#)
- UPnP [158](#)
 - forum [153](#)
 - security issues [153](#)
- USB features [24](#)
- USB printer [24](#)

V

- VAD [228](#), [315](#)
- version
 - firmware

- version **90**
- VID
- Virtual Circuit (VC) **114**
- Virtual Local Area Network See VLAN
- Virtual Local Area Network, see VLAN
- VLAN **116, 252**
 - group **252**
 - ID **252**
 - ID tags **252**
 - Introduction **116**
 - number of possible VLANs
 - priority frame
 - static
- VLAN ID **116**
- VLAN Identifier See VID
- VLAN tag **116**
- voice activity detection **228, 315**
- voice channels **315**
- voice coding **250**
- VoIP **245**
 - features **23**
 - peer-to-peer calls **243**
 - standards compliance **315**
 - tutorial **51**
- VoIP features **23**

W

- WAN
 - Wide Area Network, see WAN **93**
- warnings **7**
- warranty **426**
 - note **426**
- Web Configurator **29**
- web configurator
 - passwords **30**
- WEP **127, 141, 316**
- WEP Encryption **128**
- Wi-Fi Protected Access, see WPA
- Wired Equivalent Privacy, see WEP
- wireless
 - client configuration **42**
 - profile **45**
 - security **378**

- tutorial **40**
- wireless client WPA supplicants **384**
- wireless LAN **121**
 - authentication **138, 140**
 - BSS **141**
 - example **142**
 - channel **123**
 - encryption **140**
 - example **122**
 - fragmentation threshold **138**
 - limitations **141**
 - MAC address filter **139, 316**
 - MBSSID **142**
 - preamble **138**
 - RADIUS server **140**
 - RTS/CTS threshold **138**
 - scheduling **137**
 - security **138**
 - SSID **139**
 - activation **132**
 - WEP **141**
 - WPA **141**
 - WPA-PSK **141**
 - WPS **143, 145**
 - example **147**
 - limitations **148**
 - PIN **144**
 - push button **143**
- wireless network
 - example **121**
- wireless security **378**
- WLAN **121**
 - auto-scan channel **125**
 - interference **375**
 - passphrase **127**
 - scheduling **137**
 - security parameters **386**
 - see also wireless.
 - WEP **127**
- WLAN button **25**
- WPA **141, 316, 382**
 - key caching **384**
 - pre-authentication **384**
 - user authentication **384**
 - vs WPA-PSK **383**
 - wireless client supplicant **384**
 - with RADIUS application example **384**
- WPA2 **382**

- user authentication [384](#)
- vs WPA2-PSK [383](#)
- wireless client supplicant [384](#)
- with RADIUS application example [384](#)
- WPA2-Pre-Shared Key, see WPA2-PSK
- WPA2-PSK [382](#), [383](#)
 - application example [385](#)
- WPA-PSK [141](#), [383](#)
 - application example [385](#)
- WPS [143](#), [145](#)
 - example [147](#)
 - limitations [148](#)
 - PIN [144](#)
 - example [145](#)
 - push button [143](#)