



# ZXV10 W300

## Wireless ADSL Router

### Maintenance Manual

---

Version 5.2

ZTE CORPORATION  
ZTE Plaza, Keji Road South,  
Hi-Tech Industrial Park,  
Nanshan District, Shenzhen,  
P. R. China  
518057  
Tel: (86) 755 26771900 800-9830-9830  
Fax: (86) 755 26772236  
URL: <http://support.zte.com.cn>  
E-mail: [doc@zte.com.cn](mailto:doc@zte.com.cn)

---

## LEGAL INFORMATION

Copyright © 2010 ZTE CORPORATION.

The contents of this document are protected by copyright laws and international treaties. Any reproduction or distribution of this document or any portion of this document, in any form by any means, without the prior written consent of ZTE CORPORATION is prohibited. Additionally, the contents of this document are protected by contractual confidentiality obligations.

All company, brand and product names are trade or service marks, or registered trade or service marks, of ZTE CORPORATION or of their respective owners.

This document is provided "as is", and all express, implied, or statutory warranties, representations or conditions are disclaimed, including without limitation any implied warranty of merchantability, fitness for a particular purpose, title or non-infringement. ZTE CORPORATION and its licensors shall not be liable for damages resulting from the use of or reliance on the information contained herein.

ZTE CORPORATION or its licensors may have current or pending intellectual property rights or applications covering the subject matter of this document. Except as expressly provided in any written license between ZTE CORPORATION and its licensee, the user of this document shall not acquire any license to the subject matter herein.

The contents of this document and all policies of ZTE CORPORATION, including without limitation policies related to support or training are subject to change without notice.

---

## **Revision History**

<b>Date</b>	<b>Revision No.</b>	<b>Serial No.</b>	<b>Description</b>
2010/12/07	R1.0		First Edition

# Contents

---

<b>About this Manual</b>	<b>i</b>
Purpose of this Manual	i
Typographical Conventions	i
Mouse Operation Conventions	ii
Safety Signs	ii
How to Get in Touch	iii
Customer Support	iii
Documentation Support	iii
<b>Safety Instructions</b>	<b>v</b>
During Installation and Application	v
For Service	vi
<b>Chapter 1</b>	<b>1</b>
<b>Introduction</b>	<b>1</b>
Overview	1
Packing List	2
Front Panel	2
Rear Panel	4
System Requirements	4
<b>Chapter 2</b>	<b>7</b>
<b>Product Installation</b>	<b>7</b>
Hardware Connections	7
Default Settings	10
Computer Configuration	10

Checking Computer Configuration.....	10
Configuring TCP/IP.....	11
<b>Chapter 3.....</b>	<b>13</b>
<b>Configuration Page Login.....</b>	<b>13</b>
<b>Chapter 4.....</b>	<b>16</b>
<b>Interface Setup.....</b>	<b>16</b>
Internet Configuration.....	17
ATM VC and ATM Qos.....	17
Encapsulation.....	19
LAN Configuration.....	24
Router Local IP.....	24
DHCP.....	25
Wireless Configuration.....	26
Access Point Settings.....	27
Multiple SSIDs Settings.....	28
Wireless MAC Address Filter.....	29
<b>Chapter 5.....</b>	<b>30</b>
<b>Advanced Setup.....</b>	<b>30</b>
Firewall Configuration.....	30
Routing Configuration.....	31
NAT Configuration.....	32
QoS Configuration.....	33
VLAN Configuration.....	34
ADSL Configuration.....	37
<b>Chapter 6.....</b>	<b>38</b>
<b>Access Management.....</b>	<b>38</b>
ACL Management.....	38
Filter Management.....	40

UPnP Management.....	41
DDNS Management.....	42
CWMP Management.....	43
<b>Chapter 7.....</b>	<b>47</b>
<b>Maintenance.....</b>	<b>47</b>
Administration Configuration.....	47
Time Zone Configuration.....	48
Firmware Configuration.....	48
SysRestart Configuration.....	49
Diagnostics.....	49
<b>Chapter 8.....</b>	<b>51</b>
<b>Status.....</b>	<b>51</b>
Device Information.....	51
System Log.....	52
Statistics.....	53
<b>Chapter 9.....</b>	<b>56</b>
<b>Troubleshooting.....</b>	<b>56</b>
<b>Appendix A.....</b>	<b>58</b>
<b>Technical Specifications.....</b>	<b>58</b>
<b>Appendix B.....</b>	<b>61</b>
<b>Computer WLAN Configuration.....</b>	<b>61</b>
<b>Appendix C.....</b>	<b>69</b>
<b>PPPoE Dial-up Configuration.....</b>	<b>69</b>
<b>Figures.....</b>	<b>75</b>
<b>Tables.....</b>	<b>79</b>

# About this Manual

---




## Purpose of this Manual

This manual provides the basic information of installing, configuring and maintaining the ZXV10 W300 (V5.2) wireless ADSL router (hereinafter W300). It is a reference book for the maintenance personnel of W300.

## Typographical Conventions

ZTE documents employ the following typographical conventions.

**TABLE 1 TYPOGRAPHICAL CONVENTIONS**

Typeface	Meaning
<i>Italics</i>	References to other guides and documents; parameter values
“Quotes”	Links on screens
<b>Bold</b>	Menus, menu options, input fields, radio button names, check boxes, drop-down lists, dialog box names, window names
CAPS	Keys on the keyboard and buttons on screens and company name
Constant width	Text that you type, program code, files and directory names, and function names
[ ]	Optional parameters
{ }	Mandatory parameters
	Select one of the parameters that are delimited by it
	Note: Provides additional information about a certain topic
	Checkpoint: Indicates that a particular step needs to be checked before proceeding further
	Tip: Indicates a suggestion or hint to make things easier or more productive for the reader









# Mouse Operation Conventions







**TABLE 2 MOUSE OPERATION CONVENTIONS**

Typeface	Meaning
Click	Refers to clicking the primary mouse button (usually the left mouse button) once.
Double-click	Refers to quickly clicking the primary mouse button (usually the left mouse button) twice.
Right-click	Refers to clicking the secondary mouse button (usually the right mouse button) once.
Drag	Refers to pressing and holding a mouse button and moving the mouse.

# Safety Signs

**TABLE 3 SAFETY SIGNS**

Safety Signs	Meaning
	Danger: Indicates an imminently hazardous situation, which if not avoided, will result in death or serious injury. This signal word should be limited to only extreme situations.
	Warning: Indicates a potentially hazardous situation, which if not avoided, could result in death or serious injury.
	Caution: Indicates a potentially hazardous situation, which if not avoided, could result in minor or moderate injury. It may also be used to alert against unsafe practices.
	Erosion: Beware of erosion.
	Electric shock: There is a risk of electric shock.
	Electrostatic: The device may be sensitive to static electricity.
	Microwave: Beware of strong electromagnetic field.
	Laser: Beware of strong laser beam.

Safety Signs	Meaning
	Danger: Indicates an imminently hazardous situation, which if not avoided, will result in death or serious injury. This signal word should be limited to only extreme situations.
	Warning: Indicates a potentially hazardous situation, which if not avoided, could result in death or serious injury.
	Caution: Indicates a potentially hazardous situation, which if not avoided, could result in minor or moderate injury. It may also be used to alert against unsafe practices.
	No flammables: No flammables can be stored.
	No touching: Do not touch.
	No smoking: Smoking is forbidden.

## How to Get in Touch

The following sections provide information on how to obtain support for the documentation and the software.

## Customer Support

If you have problems, questions, comments, or suggestions regarding your product, contact us by e-mail at [support@zte.com.cn](mailto:support@zte.com.cn). You can also call our customer support center at (86) 755 26771900 and (86) 800-9830-9830.

## Documentation Support

ZTE welcomes your comments and suggestions on the quality and usefulness of this document. For further questions, comments, or suggestions on the documentation, you can contact us by e-mail at [doc@zte.com.cn](mailto:doc@zte.com.cn); or you can fax your comments and suggestions to (86) 755 26772236. You can also explore our website at <http://support.zte.com.cn>, which contains various interesting subjects like documentation, knowledge base, forum and service request.



This page is intentionally blank.

# Safety Instructions

---

## During Installation and Application

- Use the power adapter included in this package. Another power adaptor may make the device unable to work normally or even damage the device.
- Note the power load of the power socket and power cable. The overloading power socket or broken power cable may cause an electric shock or fire. It is recommended to check the cables periodically and replace the broken one immediately.
- Appropriate space for heat dissipation is required to prevent the product from overheating.
- Keep the product away from heat sources. Avoid the product working in high-temperature or direct sunshine environment.
- Keep the product away from moisture or vapor. Do not splash any fluid on the product.
- Do not place the product on any unstable surface.
- Power off and unplug this product carefully when it is not in use or before cleaning. Pay attention to the high temperature on the transformer's surface.
- Wait for at least 15 seconds between powering off and re-powering on of the device.
- Do not block the heat dissipation opening of the product.
- When the product is not used for a long period of time, unplug the power cord.

## For Service

Do not attempt to disassemble, repair, or open this product, which will lose the warranty services. Contact qualified service personnel in case of problems, especially under the following conditions:

- The power socket or cable is damaged.
- Liquid is splashed into the product.
- The product is exposed to rain or water.
- The product does not work normally when the operating instructions are followed.
- The product is dropped or struck, causing the product damaged.

# Chapter 1

## Introduction

---

This chapter gives an overview of the W300 router, presents the packing list, introduces the front and rear panels and system requirements.

## Overview

W300 is a home and SOHO oriented wireless broadband router integrating A DSL, AP and LAN Switch. It provides triple-play services such as Internet data, voice access, and video access. W300 provides priority access for different services with sophisticated ATM-based and IP-based QoS to meet different requirements for high-speed Internet access, IPTV Video on Demand (VoD), live-broadcast access and voice access. Wireless encryption and built-in firewall prevent unauthorized users from accessing the network, ensuring the security of legal users accessing the wired and wireless networks. W300 supports TR-069 protocols for allowing overall remote network management.



**Note:** ZTE CORPORATION reserves the right to modify technical specifications in this manual without any notification in advance.

---

# Packing List

The package box for a W300 includes the following components, as shown in Table 4.

**TABLE 4 PACKING LIST**

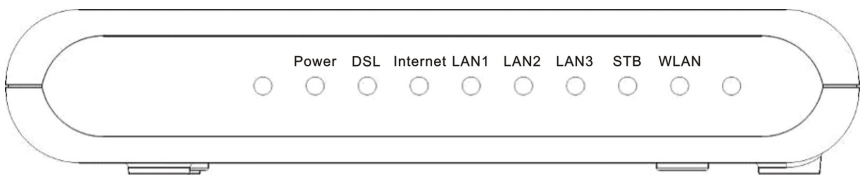
Component	Quantity
ZXV10 W300 Wireless ADSL Router	1
External splitter	1
Power adapter	1
Telephone line	2
Straight-through Ethernet cable	1
Warranty card	1
ZXV10 W300 V5.2 Wireless ADSL Router User Manual	1



**Note:** Components actually delivered depend on the service provider. If any component is missing or damaged, immediately contact the service provider. Please keep the packing box and components well in case of replacement.

## Front Panel

**FIGURE 1 FRONT PANEL**



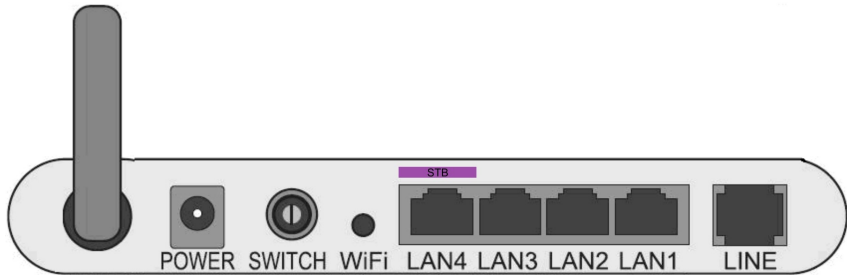
There are eight indicators on the front panel of a W300 indicating the running status of the device, as shown in Figure 1. These indicators are described in Table 5.

**TABLE 5 DESCRIPTIONS FOR THE INDICATORS**

Indicator	Color	Description
Power	Red/Green	<ul style="list-style-type: none"> <li>▪ Red: Indicates the power is just connected or it fails to function.</li> <li>▪ Green Steady on: Indicates switched on.</li> <li>▪ Off: Indicates the power has not been connected</li> </ul>
DSL	Green	<ul style="list-style-type: none"> <li>▪ Steady on: Indicates a DSL link is established.</li> <li>▪ Slow flashing: Indicates no signal is detected.</li> <li>▪ Fast flashing: Indicates the MODEM is activating.</li> </ul>
Internet	Green	<ul style="list-style-type: none"> <li>▪ Steady on: Indicates operating in Route mode and the ADSL link is established. The IP data packet of the MODEM can be transmitted and received normally (For example, the embedded PPPOE link is established and a dynamic IP address is allocated.).</li> <li>▪ Flashing: Indicates operating in Route mode and there is data packet passing the MODEM.</li> <li>▪ Off: Indicates operating in Bridge mode or ADSL link is not established.</li> </ul>
LAN1 LAN2 LAN3 STB	Green	<ul style="list-style-type: none"> <li>▪ Steady on: Indicates a LAN connection is established.</li> <li>▪ Flashing: Indicates data is transmitting.</li> <li>▪ Off: Indicates the LAN connection has not been established</li> </ul>
WLAN	Green	<ul style="list-style-type: none"> <li>▪ Steady on: Indicates the wireless module is on.</li> <li>▪ Flashing: Indicates wireless data is transmitting.</li> <li>▪ Off: Indicates the wireless module is off.</li> </ul>

# Rear Panel

FIGURE 2 REAR PANEL



There are seven ports and buttons on the rear panel of a W300, as shown in Figure 2. These ports and buttons are described in Table 6.

TABLE 6 DESCRIPTIONS FOR THE PORTS AND BUTTONS

Identification	Description
POWER	Connected to the companion power adapter.
SWITCH	Power switch
LINE	Connected to the ADSL line or splitter via RJ-11 telephone line.
LAN1~ LAN3 & STB	Connected to PC's network interface card (NIC) or another network device via RJ-45 cable. For Ethernet uplink mode, connect the Ethernet subscriber line to LAN1 port.

## System Requirements

System requirements for the W300 router are as follows:

- The user has already subscribed the ADSL or Ethernet service. The service provider shall provide at least one legal IP address (allocated either statically or dynamically).
- One or more PCs with 10/100M Ethernet Network Interface Card (NIC).

- For wireless access, an external or built-in 802.11b/g/n wireless adapter is required.
- To configure the system via the web page based interface, you need a web browser such as Internet Explorer (version6.0 or above), Netscape (version4.7 or above).



This page is intentionally blank.

## Chapter 2

# Product Installation

---

This chapter shows hardware connections for installing W300, presents factory default settings, and describes how to configure a computer for using W300.

## Hardware Connections

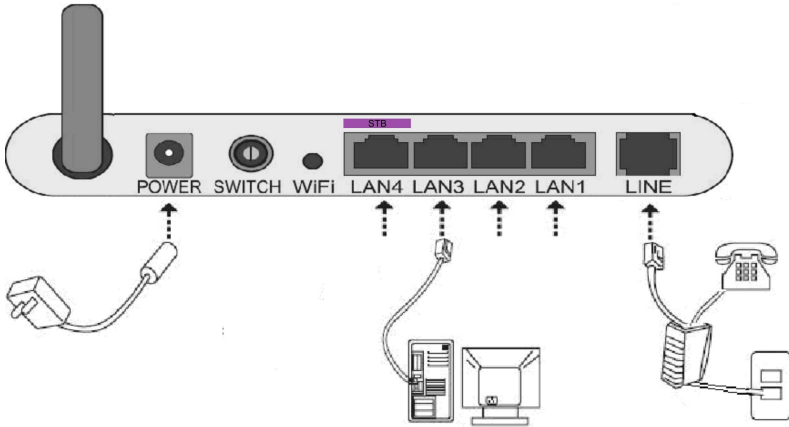
1. Place the W300 router on the plane surface. Minimize obstacles and the distance between the W300 router and the wireless terminal.
2. ADSL/Ethernet uplink connection

A W300 router can access the ISP's network in either ADSL uplink mode or Ethernet uplink mode.

- ADSL uplink

The user is suggested to adopt the following connection method for ADSL uplink mode, as shown in Figure 3.

**FIGURE 3 ADSL UPLINK CONNECTIONS**

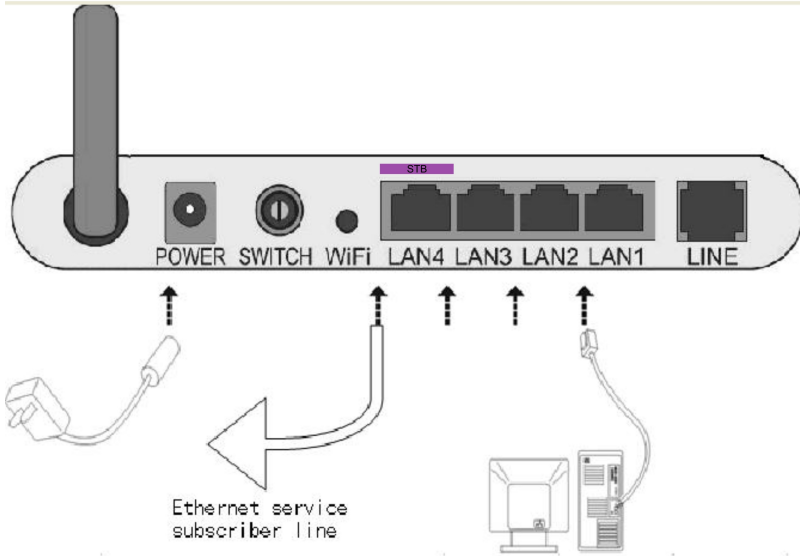


If a telephone needs to be installed in front of the splitter, the user must connect a voice filter in the Line port of the splitter; then connect the phone to the splitter's Phone port. The other port connections can be referred to Figure 3.

A splitter consists of three ports:

- Line: The port connected to the ADSL subscriber line.
  - Modem: The port connected to the W300's LINE port.
  - Phone: The port connected to a phone.
- Ethernet uplink
- Port connections for Ethernet uplink mode can be referred to Figure 4. Connect one end of the RJ-45 Ethernet cable to the W300's LAN1 port, and another end to the ISP's network.

FIGURE 4 ETHERNET UPLINK CONNECTIONS



3. Use an RJ-45 cable to connect the W300's **LAN4** port to a computer or another network device.
4. Connect the power adapter to the device and plug the power adapter to the AC power outlet. W300 will be on after pushing the power switch button.



**Caution:** Please use the companion power adapter. The other power adaptor may make W300 unable to work normally or even damage it.

# Default Settings

The factory default settings for a W300 router are listed as follows:

- IP address: 192.168.1.1; subnet mask: 255.255.255.0.
- Use the DHCP server by default (i.e., the IP address can be obtained from the W300 automatically via DHCP).
- Line coding: Auto negotiation (T1.413/G.DMT/G.LITE/ADSL2 /ADSL2+).
- Default network name (SSID) for WLAN, wireless encryption mode, and encryption key are also marked on the label shown on the cover of the W300 router.



---

**Note:** If the W300 router fails to work due to error configuration or if the user forgets the login password, insert a needle into the device's **Reset** hole when the device is running and hold **Reset** down for more than 10 seconds to restore the settings to the default ones, then the system restarts automatically.

---

## Computer Configuration

This section shows how to check computer configuration and configure TCP/IP for a W300.

### Checking Computer Configuration

If the computer uses a proxy server to access the Internet, it is suggested to disable this proxy service before performing the configurations. It is recommended to close the VPN software and the firewalls running on the computer. For example, in Microsoft Internet Explorer, the user may check the proxy service configuration as follows:

1. In the browser, select **Tools > Internet Options**.
2. Click the **Connections** tab and then click the **LAN Settings** button.
3. Uncheck the **Use a proxy server for your LAN** box if it is checked.
4. Click the **OK** button.

## Configuring TCP/IP

If the operating system of the computer is one of the following ones: Windows 95, Windows 98, Windows ME, Windows 2000, and Windows XP, there are two ways for configuring the computer (the first one is recommended). The following instruction uses Windows XP as an example (the method under another operation system is similar).

- To obtain an address from the W300 via DHCP, perform the following procedure in the computer:
  1. In Windows taskbar, select **Start > Control Panel**.
  2. Double-click the **Network Connection** icon.
  3. Right click **Local Area Connection**, and select **Properties**.
  4. Select **Internet Protocol (TCP/IP)**, and then click the **Properties** button.
  5. In the **Internet Protocol (TCP/IP) Properties** dialog box, check **Obtain an IP address automatically** and check **Obtain DNS server address automatically**.
  6. Click **OK** to confirm and save the settings.
- To configure a static address, perform the following procedure in the computer:
  1. In Windows taskbar, select **Start > Control Panel**.
  2. Double-click the **Network Connection** icon.
  3. Right click **Local Area Connection**, and select **Properties**.
  4. Select **Internet Protocol (TCP/IP)**, and then click the **Properties** button.
  5. In **Internet Protocol (TCP/IP) Properties** dialog box, check **Use the following IP address** to specify this computer's IP address. This IP address

ess shall be in the same network segment as the LAN port address of the W300 and shall be in the form 192.168.1.x (x is a decimal integer between 2~254, for example, 192.168.1.2). Subnet mask is set to 255.255.255.0. Default gateway is set to 192.168.1.1.

6. Check **Use the following DNS server addresses**. To set the IP addresses of the DNS server, contact local service provider or set it to 192.168.1.1.

Click **OK** to confirm and save the settings.

## Chapter 3

# Configuration Page Login

---

This chapter introduces how to log into the configuration page and presents the default main page after login.

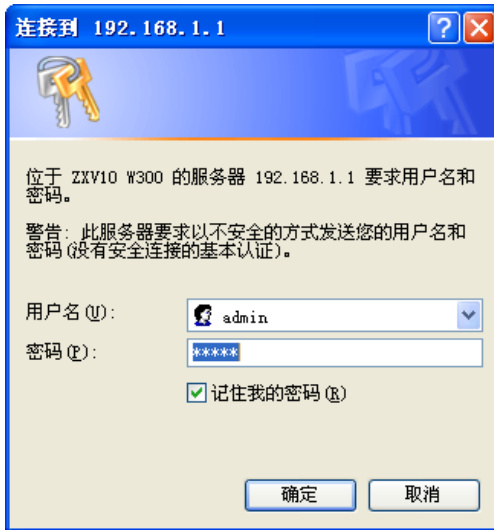
Follow the precedures below to log into the web configuration page.

□ To log into configuration page:

1. Open a browser (e.g, IE) and type **http://192.168.1.1** (i.e., default IP address of the W300's LAN port) in the address bar.
2. Press the **Enter** key of the keyboard to display the login dialog box, as shown in Figure 5.



FIGURE 5 THE LOGIN DIALOG BOX



3. Enter the default user name **admin** and password **admin**, and then click the **OK** button to enter the main page for configuration, as shown in Figure 6.

FIGURE 6 MAIN PAGE FOR CONFIGURATION

ZTE中兴 ZXV10 W300

Status	Interface Setup	Advanced Setup	Access Management	Maintenance	Status
	Device Info	System Log	Statistics		
<b>Device Information</b>	Firmware Version : W300V1.0.0a_ZRD_OV MAC Address : d0:15:4a:01:e2:3a				
<b>LAN</b>	IP Address : 192.168.1.1 Subnet Mask : 255.255.255.0 DHCP Server : Disabled				
<b>WAN</b>	Virtual Circuit : <input type="text" value="PVC0"/> <input type="button" value="v"/> Status : Not Connected Connection Type : Bridge IP Address : N/A Subnet Mask : N/A Default Gateway : N/A Primary DNS : N/A Secondary DNS : N/A				
<b>ADSL</b>	ADSL Firmware Version : FwVer:3.12.8.200_TC3086 HwVer:T14.F7_7.0 Line State : Down Modulation : N/A Annex Mode : N/A				
		Downstream	Upstream		
	SNR Margin :	N/A	N/A	db	
	Line Attenuation :	N/A	N/A	db	
	Data Rate :	N/A	N/A	kbps	

The main page shows the device information of the W300 ADSL router.

## Chapter 4

# Interface Setup

---

This chapter describes the Internet and local network configuration of the W300 Router.

After logging into the configuration main page, click **Interface Setup** to open the page shown in Figure 7.

FIGURE 7 THE INTERFACE SETUP PAGE

Interface	Interface Setup	Advanced Setup	Access Management	Maintenance	Status
	Internet	LAN	Wireless		
<b>ATM VC</b>	Virtual Circuit : <input type="text" value="PVC0"/> <input type="button" value="PVCs Summary"/> Status : <input checked="" type="radio"/> Activated <input type="radio"/> Deactivated VPI : <input type="text" value="8"/> (range: 0-255) VCI : <input type="text" value="81"/> (range: 1-65535)				
<b>QoS</b>	ATM QoS : <input type="text" value="UBR"/> PCR : <input type="text" value="0"/> cells/second SCR : <input type="text" value="0"/> cells/second MBS : <input type="text" value="0"/> cells				
<b>Encapsulation</b>	ISP : <input type="radio"/> Dynamic IP Address <input type="radio"/> Static IP Address <input type="radio"/> PPPoA/PPPoE <input checked="" type="radio"/> Bridge Mode				
<b>Bridge Mode</b>	Encapsulation : <input type="text" value="1483 Bridged IP LLC"/>				
<input type="button" value="SAVE"/> <input type="button" value="DELETE"/>					

Three sub-pages are under the **Interface Setup** page, which are **Internet**, **LAN** and **Wireless**.

## Internet Configuration

By default the **Interface Setup** page displays the **Internet** configuration page as shown in Figure 7.

### ATM VC and ATM Qos

Asynchronous transfer mode (ATM) is a protocol that arranges data into small, uniform-sized cells with VCI data, as opposed to variable-sized data packets. ATM settings are used to connect to ISP. ISP provides the VPI and VCI setting information. The users of W300 can configure up to 8 virtual circuits (VC), each using different encapsulation. Each VC must be activated to take effect. For permanent virtual circuit (PVC) management, users can use ATM Quality of Service (Qos) to set up each PVC traffic line's priority.

Table 7 presents the ATM VC and Qos parameters descriptions.

**TABLE 7 THE DESCRIPTIONS OF ATM VC & QOS PARAMETERS**

Parameter	Description
Virtual Circuit	Select the PVC to be modified
Status	Each PVC can be toggled <b>Activated</b> or <b>Deactivated</b>
VPI	Enter the VPI number
VCI	Enter the VCI number
ATM Qos	Select the Qos type for the PVC from the dropdown list
PCR	Enter the PCR. For all Qos types
SCR	Enter the SCR. Only for rtVBR and nrtVBR
MBS	Enter the MBS. Only for rtVBR and nrtVBR

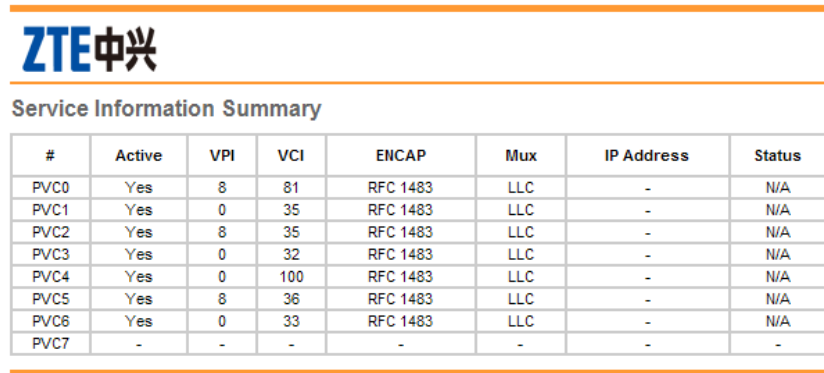
## Definitions

- PCR: Peak Cell Rate, is the maximum rate at which the sender can send cells. This parameter may be lower (but not higher) than the maximum line speed. One ATM cell is 53 bytes (424 bits), so a maximum speed of 832 Kbps gives a maximum PCR of 1962 cells/sec. This rate not guaranteed because it is dependent on the line speed.
- SCR: Sustained Cell Rate is the mean cell rate of a bursting, on-off traffic source that can be sent at the peak rate, and a parameter for burst-type traffic. SCR may not be greater than the PCR; the system default is 0 cells/sec.
- MBS: Maximum Burst Size is the maximum number of cells that can be sent at the PCR. After MBS is reached, cell rates fall below SCR until cell rate averages to the SCR again. At this time, more cells (up to the MBS) can be sent at the PCR again.
- CBR: It is for connections that support constant rates of data transfer.
- UBR: It is for connections that have variable traffic.
- rtVBR: It is for connections that, while having variable traffic, require precise timing between traffic source and destination. PCR, SCR and MBS must all be set for rtVBR.

- nrtVBR: It is for connections that have variable traffic, do not require precise timing, but still require a set bandwidth availability. PCR, SCR and MBS must all be set for nrtVBR.

The **PVCs Summary** button opens a new window that displays the current PVC settings, as shown in Figure 8.

FIGURE 8 THE PVC SUMMARY TABLE



#	Active	VPI	VCI	ENCAP	Mux	IP Address	Status
PVC0	Yes	8	81	RFC 1483	LLC	-	N/A
PVC1	Yes	0	35	RFC 1483	LLC	-	N/A
PVC2	Yes	8	35	RFC 1483	LLC	-	N/A
PVC3	Yes	0	32	RFC 1483	LLC	-	N/A
PVC4	Yes	0	100	RFC 1483	LLC	-	N/A
PVC5	Yes	8	36	RFC 1483	LLC	-	N/A
PVC6	Yes	0	33	RFC 1483	LLC	-	N/A
PVC7	-	-	-	-	-	-	-

## Encapsulation

Four ISP connection modes can be selected according to requirement.

- Dynamic IP Address: Choose this option to obtain an IP address automatically from the ISP.
- Static IP Address: Choose this option to set static IP information provided by the ISP.
- PPPoE/PPPoA: Choose this option if the ISP uses PPPoE/PPPoA.
- Bridge Mode: Choose this option if the ISP uses bridge mode.

## Dynamic IP address

Figure 9 shows the dynamic IP address parameters on the web configuration page and Table 8 gives the descriptions of the parameters.

FIGURE 9 DYNAMIC IP ADDRESS PARAMETERS

Dynamic IP	
Encapsulation :	1483 Bridged IP LLC
Bridge Interface :	<input type="radio"/> Activated <input checked="" type="radio"/> Deactivated
NAT :	Enable
Default Route :	<input checked="" type="radio"/> Yes <input type="radio"/> No
TCP MTU Option :	TCP MTU(default:1500) 1500 bytes
Dynamic Route :	RIP2-B Direction : Both
Multicast :	IGMP v2

TABLE 8 THE DESCRIPTIONS OF THE DYNAMIC IP ADDRESS PARAMETERS

Parameter	Description
Encapsulation	Select the encapsulation type from the dropdown list
NAT	Select whether NAT is enabled or disabled
Default Route	Select whether this PVC will be the default route for the Internet data
Dynamic Route	Select the RIP type and direction from the dropdown lists
Multicast	Select the multicast protocol to be used from the dropdown list

## Static IP Address

Figure 10 shows the static IP address parameters on the web configuration page and Table 9 gives the parameter descriptions.

FIGURE 10 STATIC IP ADDRESS PARAMETERS

Static IP	
Encapsulation :	1483 Routed IP LLC(IPoA)
Static IP Address :	192.168.2.1
IP Subnet Mask :	255.255.255.0
Gateway :	192.168.2.254
NAT :	Enable
Default Route :	<input checked="" type="radio"/> Yes <input type="radio"/> No
TCP MTU Option :	TCP MTU(default:1500) 1500 bytes
Dynamic Route :	RIP2-B Direction : Both
Multicast :	IGMP v2

TABLE 9 THE DESCRIPTIONS OF THE STATIC IP ADDRESS PARAMETERS

Parameter	Description
Encapsulation	Select the encapsulation type from the dropdown list
Static IP Address	Enter the static IP address
IP Subnet Mask	Enter the IP subnet mask
Gateway	Enter the gateway address
NAT	Select whether NAT is enabled or disabled
Default Route	Select whether this PVC will be the default route for the Internet data
Dynamic Route	Select the RIP type and direction from the dropdown lists
Multicast	Select the multicast protocol to be used from the dropdown list




---

**Note:** The parameters listed in Table 9 should be provided by the ISP.

---

## PPPoE/PPPoA

Figure 11 shows the PPPoE/PPPoA parameters on the web configuration page and Table 10 gives the parameter descriptions.



**FIGURE 11 PPPoE/PPPoA PARAMETERS**

Encapsulation	ISP: <input type="radio"/> Dynamic IP Address <input type="radio"/> Static IP Address <input checked="" type="radio"/> PPPoE/PPPoE <input type="radio"/> Bridge Mode
PPPoE/PPPoA	Servicename: <input type="text"/> Username: <input type="text"/> Password: <input type="text"/> Encapsulation: PPPoE LLC <input type="button" value="v"/> Bridge Interface: <input type="radio"/> Activated <input checked="" type="radio"/> Deactivated
Connection Setting	Connection: <input type="radio"/> Always On (Recommended) <input checked="" type="radio"/> Connect On-Demand (Close if idle for <input type="text" value="0"/> minutes) <input type="radio"/> Connect Manually TCP MSS Option: TCP MSS(default:1400) <input type="text" value="1400"/> bytes
IP Address	Get IP Address: <input checked="" type="radio"/> Static <input type="radio"/> Dynamic Static IP Address: <input type="text" value="0.0.0.0"/> IP Subnet Mask: <input type="text" value="0.0.0.0"/> Gateway: <input type="text" value="0.0.0.0"/> NAT: <input type="button" value="v"/> Enable Default Route: <input checked="" type="radio"/> Yes <input type="radio"/> No TCP MTU Option: TCP MTU(default:1492) <input type="text" value="1492"/> bytes Dynamic Route: <input type="button" value="v"/> RIP2-B      Direction: <input type="button" value="v"/> Both Multicast: <input type="button" value="v"/> IGMP v2 MAC Spoofing: <input type="radio"/> Enabled <input checked="" type="radio"/> Disabled <input type="text" value="00:00:00:00:00:00"/>
<input type="button" value="SAVE"/>	

**TABLE 10 THE DESCRIPTIONS OF THE PPPoE/PPPoA PARAMETERS**

Parameter	Description
Username	Enter the username
Password	Enter the password
Encapsulation	Select the encapsulation type from the dropdown list
Connection	Select whether your connection is always on or if it connects on demand. If on demand specify how many minutes the connection may be idle before it disconnects
TCP MSS Option	Enter the TCP MSS to be used
Get IP Address	Choose whether the W300 obtains the IP address statically or dynamically

Parameter	Description
Static IP Address	Enter the static IP address. Only if static IP is selected.
IP Subnet Mask	Enter the IP subnet mask. Only if static IP is selected.
Gateway	Enter the gateway address. Only if static IP is selected.
NAT	Select whether NAT is enabled or disabled
Default Route	Select whether this PVC will be the default route for the Internet data
Dynamic Route	Select the RIP type and direction form the dropdown lists
Multicast	Select the multicast protocol to be used from the dropdown list

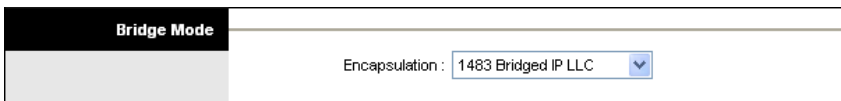


**Note:** The parameters listed in Table 10 should be provided by the ISP. The user name must be assigned by the ISP.

## Bridge Mode

Figure 12 shows the bridge mode parameters on the web configuration page and Table 11 gives the parameter descriptions.

**FIGURE 12 BRIDGE MODE PARAMETERS**



**TABLE 11 THE DESCRIPTIONS OF THE BRIDGE MODE PARAMETERS**

Parameter	Description
Encapsulation	Select the encapsulation type from the dropdown list

# LAN Configuration

Click **Interface Setup>LAN** to show the **LAN** configuration page, as shown in Figure 13.

FIGURE 13 THE LAN CONFIGURATION PAGE

The screenshot displays the LAN configuration interface for the ZTE ZXV10 W300 router. The top navigation bar includes 'Interface', 'Interface Setup', 'Advanced Setup', 'Access Management', 'Maintenance', and 'Status'. Under 'Interface Setup', 'LAN' is selected. The configuration is divided into three sections: Router Local IP, DHCP, and DNS.

**Router Local IP:**

- Main IP Address: 192.168.1.1
- Main Subnet Mask: 255.255.255.0
- Alias IP Address: 0.0.0.0
- Alias Subnet Mask: 0.0.0.0
- Dynamic Route: RIP2-B (dropdown), Direction: None (dropdown)
- Multicast: IGMP v2 (dropdown)
- IGMP Snoop:  Disabled  Enabled

**DHCP:**

- DHCP:  Disabled  Enabled  Relay

**DHCP Server:**

- Starting IP Address: 192.168.1.2 (with 'Current Pool Summary' button)
- IP Pool Count: 32
- Lease Time: 259200 seconds (0 sets to default value of 259200)
- Physical Ports:  1  2  3  4

**DNS:**

- DNS Relay: Use Auto Discovered DNS Server Only (dropdown)
- Primary DNS Server: N/A
- Secondary DNS Server: N/A

At the bottom, there are 'SAVE' and 'CANCEL' buttons.

## Router Local IP

Table 12 gives the description of the local IP parameters.

TABLE 12 THE DESCRIPTIONS OF THE LOCAL IP PARAMETERS

Parameter	Description
IP Address	Enter the W300 local IP address. By default, it is 192.168.1.1.

Parameter	Description
IP Subnet Mask	Enter the W300 IP subnet mask. By default, it is 255.255.255.0.
Dynamic Route	Select the Routing Information Protocol (RIP) to be used from the dropdown list. And select the direction from the dropdown list
Multicast	Select the multicast protocol to be used from the dropdown list

## DHCP

DHCP function can be disabled, enabled or in relay mode. Figure 13 shows the parameters when DHCP is enabled. And Table 13 gives the parameter descriptions.

**TABLE 13 THE DESCRIPTIONS OF THE DHCP PARAMETERS**

Parameter	Description
Starting IP Address	Enter the starting IP address to be used by the DHCP server's IP assignment. By default, the starting IP address is 192.168.1.2 and the ending IP address is 192.168.1.254.
IP Pool Count	Enter the maximum user pool size to be assigned.
Lease Time	Enter the amount of time to lease out a given IP address.
DNS Relay	Select the DNS relay option to be used from the dropdown list. If the users do not want to use the DNS relay option, set the DNS relay to "Use User Discovered DNS Server Only" and set both Primary and Secondary DNS servers to 0.0.0.0.
Primary DNS Server	Enter the primary DNS server IP address to be used. For user discovered DNS only.
Secondary DNS Server	Enter the secondary DNS server IP address to be used. For user discovered DNS only.

A DHCP relay is a computer that forwards DHCP data between computers that request IP address and the DHCP server that assigns the IP address. If the DHCP Relay option is enabled, DHCP requests from local PCs will be forwarded to the DHCP server that runs on WAN side. For this function working properly, W300 must run on the router mode, disable the DHCP server on the LAN port and make sure the routing table has the correct routing entry.

If relay DHCP is selected, Figure 14 will be display on the web configuration page. Table 14 describes the parameter.

**FIGURE 14 THE RELAY DHCP WEB CONFIGURATION PAGE**

DHCP

DHCP Relay

DHCP:  Disabled  Enabled  Relay

DHCP Server IP for Relay Agent:

SAVE CANCEL

**TABLE 14 THE RELAY DHCP PARAMETER**

Parameter	Description
DHCP Server IP for Relay Agent	Enter the IP address for the DHCP relay agent.

## Wireless Configuration

Click **Interface Setup>Wireless** to show the **Wireless** configuration page, as shown in Figure 15.

FIGURE 15 THE WIRELESS CONFIGURATION PAGE

ZXV10 W300

Interface	Interface Setup	Advanced Setup	Access Management	Maintenance	Status
	Internet	LAN	Wireless		

---

**Access Point Settings**

Access Point :  Activated  Deactivated  
 Channel : Auto Current Channel: 1  
 Beacon Interval : 100 ms (range: 20~1000)  
 RTS/CTS Threshold : 2347 bytes (range: 1500~2347)  
 Fragmentation Threshold : 2346 bytes (range: 256~2346, even numbers only)  
 DTIM : 1 (range: 1~255)  
 Wireless Mode : 802.11b+g+n  
 Station Number : 16 (range: 0~16)

---

**11n Settings**

Channel Bandwidth : 20/40 MHz  
 Extension Channel : above the control channel  
 Guard Interval : AUTO  
 MCS : AUTO

---

**Multiple SSIDs Settings**

SSID Index : 1  
 Broadcast SSID :  Yes  No  
 SSID : ZTE  
 Authentication Type : Disabled

---

**Wireless MAC Address Filter**

Active :  Activated  Deactivated  
 Action : Allow Association the follow Wireless LAN station(s) association.  
 Mac Address #1 : 00:00:00:00:00:00  
 Mac Address #2 : 00:00:00:00:00:00  
 Mac Address #3 : 00:00:00:00:00:00  
 Mac Address #4 : 00:00:00:00:00:00  
 Mac Address #5 : 00:00:00:00:00:00  
 Mac Address #6 : 00:00:00:00:00:00  
 Mac Address #7 : 00:00:00:00:00:00  
 Mac Address #8 : 00:00:00:00:00:00

## Access Point Settings

Table 15 describes the access point setting parameters.

TABLE 15 THE ACCESS POINT PARAMETERS

Parameter	Description
Access Point	By default, it is activated. If there is no wireless device in the network, select <b>Deactivated</b> .
Channel	Select a channel from the dropdown list.
Beacon Interval	A beacon is a packet broadcasted by the router to synchronize the wireless network. Enter a value between 20 and 1000.
RTS/CTS Threshold	The RTS (Request To Send) threshold for enabling RTS/CTS handshake. Enter a value between 1500 and 2347.
Fragmentation Threshold	The maximum fragment size that can be sent. Enter a value between 256 and 2346.
DTIM	Enter a value between 1 and 255. It indicates the interval of eh Delivery Traffic Indication Message (DTIM).
802.11 b/g/n	The default setting is 802.11 b+g+n. other modes can be selected from the dropdown list.
Station Number	Enter a value between 0 and 16

## Multiple SSIDs Settings

The SSID is the name of a wireless access point to be distinguished from another. It is case sensitive and must not exceed 32 characters. User can set multiple SSIDs for W300. Table 16 describes the parameters.

TABLE 16 THE MULTIPLE SSIDs PARAMETERS

Parameter	Description
SSID Index	Select an index number from the dropdown list.
SSID	Enter the SSID name.
Broadcast SSID	Select <b>No</b> to hide the SSID in so that a station cannot obtain the SSID through passive scanning; select <b>Yes</b> to make the SSID visible so that a station can obtain the SSID through passive scanning.
Authentication Type	Select the authentication type from the dropdown list.

## Wireless MAC Address Filter

The MAC filter function allows the user to configure the W300 to give access or deny access to specified devices. Every Ethernet device has a unique MAC (Media Access Control) address. The MAC address is assigned at the factory and consists of six pairs of hexadecimal characters, for example, 00:AA:BB:00:00:02.

Table 17 describes the parameters.

**TABLE 17 THE MAC FILTER PARAMETERS**

Parameter	Description
Active	Select <b>Activated</b> to enable MAC address filtering.
Action	Select <b>Deny Association</b> to block access to W300 or select <b>Allow Association</b> to permit access to W300
MAC Address #1 ~ #8	Enter the MAC address of the devices that are allowed or denied access to the router in these address fields.

Click the **SAVE** button to save the changes, for configurations mentioned in this chapter.



# Chapter 5

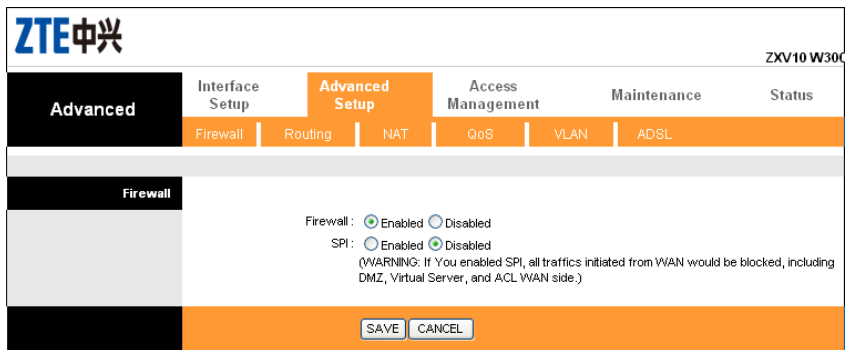
## Advanced Setup

The **Advanced Setup** configuration page determines how data enters and exits the W300 router.

### Firewall Configuration

By default the **Advanced Setup** page displays the **Firewall** configuration page as shown in Figure 7. Enable or disable the firewall and SPI according to requirements.

FIGURE 16 THE FIREWALL CONFIGURATION PAGE



# Routing Configuration

Routing directs the W300 router to forward data to specific IP address. Figure 17 shows the routing configuration page. It shows the routing rules which have been set.

FIGURE 17 THE ROUTING CONFIGURATION PAGE

ZTE中兴 ZXV10 W300

Advanced Setup | Advanced Setup | Access Management | Maintenance | Status

Firewall | Routing | NAT | QoS | VLAN | ADSL

Routing Table List

#	Dest IP	Mask	Gateway IP	Metric	Device	Use	Edit	Drop
1	192.168.1.0	24	192.168.1.1	1	enet0	282		

Note: Maximum number of static route we can add is 16!

ADD ROUTE

To add a route, click the **Add Route** button and Figure 18 displays. Set the parameters according to Table 18.

FIGURE 18 ADDING ROUTE

Static Route

Destination IP Address : 0.0.0.0

IP Subnet Mask : 0.0.0.0

Gateway IP Address : 0.0.0.0 PVC0

Metric : 0

Announced in RIP : Yes

SAVE DELETE BACK CANCEL

Click **SAVE** to save the changes; click **DELETE** to delete the parameters; click **BACK** to return to the previous screen or **CANCEL** to exit without saving.

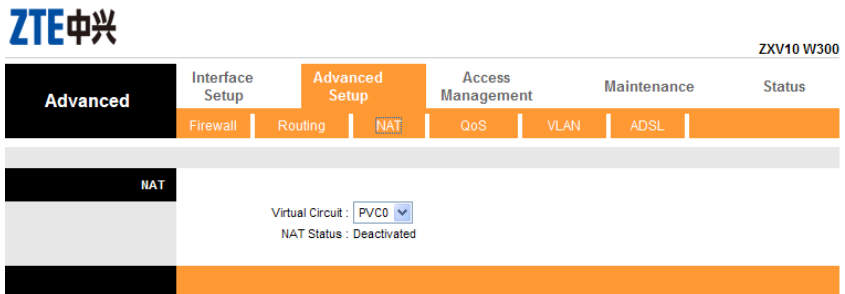
TABLE 18 THE STATIC ROUTE PARAMETERS

Parameter	Description
Destination IP Address	Enter the destination IP address for this routing rule
IP Subnet Mask	Enter the destination IP subnet mask for this routing rule
Gateway address	Enter the gateway IP address for this routing rule or select which PVC will be affected by this routing rule.
Metric	Enter the metric for this routing rule.
Announced in RIP	Choose whether this route is included in RIP broadcasts.

## NAT Configuration

Network Address Translation (NAT) translates the host IP address in a packet used within on network to a different IP address known within another network. The NAT configuration page is shown in Figure 19.

FIGURE 19 THE NAT CONFIGURATION PAGE



Select a virtual circuit (PV0 ~ PV7) and the related NAT status is displayed.

# QoS Configuration

Quality of Service (QoS) helps to prioritize the data entering the W300 router. By attaching special identification marks or headers to incoming packets, QoS determines which queue the packets enter, based on priority. Figure 20 shows the QoS configuration page.

**FIGURE 20 THE QoS CONFIGURATION PAGE**

**Quality of Service**

QoS:  Activated  Deactivated

Summary: [QoS Settings Summary](#)

Rule

Rule Index: 1

Active:  Activated  Deactivated

Application: [Dropdown]

Physical Ports:  WLAN  Enet1  Enet2  Enet3  Enet4

Destination MAC (00:00:00:00:00:00): [Text]

IP: [Text]

Mask: [Text]

Port Range: [Text] ~ [Text]

Source MAC (00:00:00:00:00:00): [Text]

IP: [Text]

Mask: [Text]

Port Range: [Text] ~ [Text]

Protocol ID: [Dropdown]

Vlan ID Range: [Text] ~ [Text]

IPP/DSP Field:  IPP/TOS  DSCP

IP Precedence Range: [Dropdown] ~ [Dropdown]

Type of Service: [Dropdown]

DSCP Range: [Text] ~ [Text] (Value Range: 0 ~ 63)

802.1p: [Dropdown] ~ [Dropdown]

Action

IPP/DSP Field:  IPP/TOS  DSCP

IP Precedence Remarking: [Dropdown]

Type of Service Remarking: [Dropdown]

DSCP Remarking: [Text] (Value Range: 0 ~ 63)

802.1p Remarking: [Dropdown]

Queue #: [Dropdown]

[SAVE](#) [DELETE](#) [CANCEL](#)

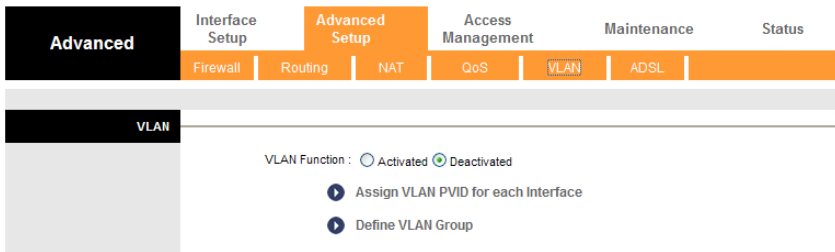
The main goal of QoS is prioritizing incoming data, preventing data loss due to factors such as jitter, delay and dropping. Another important aspect of QoS is ensuring that prioritizing one data flow doesn't interfere with other data flows. QoS can be toggled **Activated** or **Deactivated**. Activate QoS to edit the parameters listed in Figure 20. Click the **SAVE** button to submit the changes.

# VLAN Configuration

A virtual LAN (VLAN) is a switched network logically segmented by functions, project teams, or applications. The physical location of VLAN members is unimportant. VLANs allow ports on the same or different switches to be grouped so that traffic is confined to members of only that group. In high-traffic networks, VLAN can reduce the amount of data sent to unnecessary destinations.

VLAN must be activated before the user can assign VLAN PVID and define VLAN group.

**FIGURE 21 THE VLAN CONFIGURATION PAGE**



Click the link **Assign VLAN PVID for each interface** to display Figure 22. Table 19 describes the parameters.

FIGURE 22 ASSIGNING PVID

**PVID Assign**

ATM VC #0 : PVID

VC #1 : PVID

VC #2 : PVID

VC #3 : PVID

VC #4 : PVID

VC #5 : PVID

VC #6 : PVID

VC #7 : PVID

---

Ethernet Port #1 : PVID

Port #2 : PVID

Port #3 : PVID

Port #4 : PVID

---

Wireless LAN : PVID

TABLE 19 THE PVID PARAMETERS

Parameter	Description
ATM VC #0 ~ #7	Enter the PVID assigned to eight ATM VCs.
Ethernet Port #1 ~ #4	Enter the PVID assigned to four Ethernet ports.
Wireless LAN BSSID #1 ~ #4	Enter the PVID assigned to four wireless LAN BSSIDs.

Click the link **Define VLAN Group** to display Figure 23. Table 20 describes the parameters.

**FIGURE 23 DEFINING VLAN GROUP**

VLAN Group Setting

VLAN Index:

Active:  Yes  No

VLAN ID:  (Decimal)

ATM VCs:

Tagged	<input type="checkbox"/>	<input type="checkbox"/>	<input type="checkbox"/>	<input type="checkbox"/>	<input type="checkbox"/>	<input type="checkbox"/>	<input type="checkbox"/>
Port #	<input checked="" type="checkbox"/>	<input checked="" type="checkbox"/>	<input checked="" type="checkbox"/>	<input checked="" type="checkbox"/>	<input checked="" type="checkbox"/>	<input checked="" type="checkbox"/>	<input checked="" type="checkbox"/>
	0	1	2	3	4	5	6

Ethernet:

Tagged	<input type="checkbox"/>	<input type="checkbox"/>	<input type="checkbox"/>	<input type="checkbox"/>
Port #	<input checked="" type="checkbox"/>	<input checked="" type="checkbox"/>	<input checked="" type="checkbox"/>	<input checked="" type="checkbox"/>
	1	2	3	4

Wireless LAN:

Tagged	<input type="checkbox"/>
Port #	<input checked="" type="checkbox"/>
	0

**VLAN Group Summary**

Warning: if you are not familiar with the Vlan, please take care when you delete or deactivate the default Vlan group, it may cause the serious result that the modem can not be accessed!

Group	Active	ID	VLAN Group Ports	VLAN Tagged Ports
1	Yes	1	e4,e3,e2,e1,w0,p0,p1,p2,p3,p4,p5,p6,p7	

p:pvc, e:ethernet, and w:wlan

**TABLE 20 VLAN GROUP SETTING PARAMETERS**

Parameter	Description
VLAN Index	The number of the index is determined by the model or IC.
Active	Toggle this index on or off with <b>Yes</b> and <b>No</b> .
VLAN ID	Enter the VLAN ID number.
ATM VCs	Checking the <b>Tagged</b> and <b>Port#</b> box for each port number will add a tag to let other devices know if they need to check the packet and allow the packet through to the port in question.
Ethernet	Checking the <b>Tagged</b> and <b>Port#</b> box for each port number will add a tag to let other devices know if they need to check the packet and allow the packet through to the port in question.
Wireless LAN	Checking the <b>Tagged</b> and <b>Port#</b> box for each port number will add a tag to let other devices know if they need to check the packet and allow the packet through to the port in question.

Click **SAVE** to submit the changes, or **DELETE** to delete the rule with the parameters, or **CANCEL** to exit without saving.

## ADSL Configuration

Figure 24 shows the ADSL configuration page and Table 21 describes the parameters.

FIGURE 24 THE ADSL CONFIGURATION PAGE

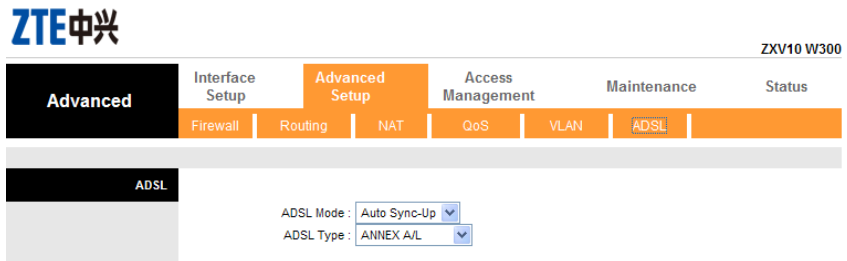


TABLE 21 THE ADSL PARAMETERS

Parameter	Description
ADSL Mode	Select the ADSL connection mode uses from the dropdown list.
ADSL Type	Select the ADSL type from the dropdown list.

Click the **SAVE** button to submit the changes.



## Chapter 6

# Access Management

---

The **Access Management** configuration page determines which device and application can access the network.

## ACL Management

Access Control Listing (ACL) acts as a filter for incoming or outgoing packets, based on application.

FIGURE 25 THE ACL MANAGEMENT PAGE

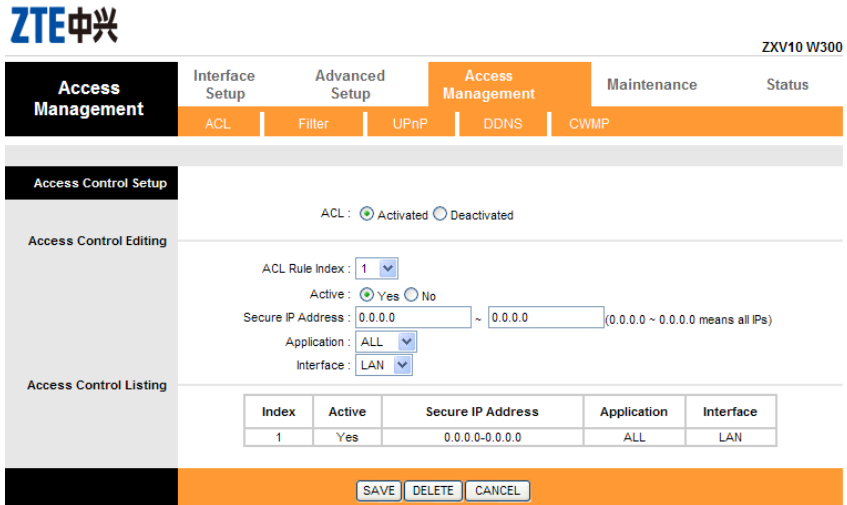


Figure 25 shows the configuration page and Table 22 describes the parameters.

TABLE 22 THE ACL MANAGEMENT PARAMETERS

Parameter	Description
ACL	ACL must be activated before editing the settings.
ACL Rule Index	Select the rule index from the dropdown list.
Active	Toggle the rule ON or OFF with <b>Yes</b> or <b>No</b> .
Secure IP Address	Enter the IP address to allow access. If 0.0.0.0 is entered, all packets are allowed.
Application	Select the application to allow access. The web browser must be allowed first; otherwise the web configuration page cannot be accessed.
Interface	Select the interface the above rules to be applied for.

Click **SAVE** to submit the changes, or **DELETE** to delete the rule with the parameters, or **CANCEL** to exit without saving.

# Filter Management

IP filter is a more complex filtering tool, based more on IP and custom rules. Each of the indices can hold six rules, and each interface can have four associated indices, allowing 24 rules per interface.

FIGURE 26 THE FILTER MANAGEMENT PAGE

ZXV10 W300

Access Management
Interface Setup
Advanced Setup
Access Management
Maintenance
Status

ACL
Filter
UPnP
DDNS
CWMP

Filter

Filter Type

Filter Type Selection: IP / MAC Filter

IP / MAC Filter Set Editing

IP / MAC Filter Set Index: 1

Interface: PVC0

Direction: Both

IP / MAC Filter Rule Editing

IP / MAC Filter Rule Index: 1

Rule Type: IP

Active:  Yes  No

Source IP Address:  (0.0.0.0 means Don't care)

Subnet Mask:

Port Number:  (0 means Don't care)

Destination IP Address:  (0.0.0.0 means Don't care)

Subnet Mask:

Port Number:  (0 means Don't care)

Protocol: TCP

Rule Unmatched: Forward

IP / MAC Filter Listing

IP / MAC Filter Set Index: 1    Interface: -    Direction: -

#	Active	Src Address/Mask	Dest IP/Mask	Src Port	Dest Port	Protocol	Unmatched
1	-	-	-	-	-	-	-
2	-	-	-	-	-	-	-
3	-	-	-	-	-	-	-
4	-	-	-	-	-	-	-
5	-	-	-	-	-	-	-
6	-	-	-	-	-	-	-

SAVE
DELETE
CANCEL

TABLE 23 THE FILTER MANAGEMENT PARAMETERS

Parameter	Description
Filter Type Selection	Select the IP filter to be viewed
IP Filter Set Index	Select the IP filter set to be modified
Interface	Select the interface to be modified. PV0~PV7 and WAN interfaces.
Direction	Select which direction of data flow to apply to the filters.
IP Filter Rule Index	Select IP filter rule index to be modified.
Active	Toggle this rule index ON or OF with <b>Yes</b> or <b>No</b> .
Source IP Address	Enter the source IP address to deny access to the W300 router.
Subnet Mask	Enter the subnet mask of the source IP address.
Port Number	Enter the port number of the source IP address. <b>0</b> means that all ports are allowed.
Destination IP Address	Enter the destination IP address to deny access to the W300 router.
Subnet Mask	Enter the subnet mask of the destination IP address.
Port Number	Enter the port number of the destination IP address. <b>0</b> means that all ports are allowed.
Protocol	Select the protocol to filter.
Rule Unmatched	Select what happens to the data in question if the rule currently editing is unmatched. <b>Next</b> means that the data is then compared to the next IP filter rule. <b>Forward</b> means that the data will be allowed into the user system.

Click **SAVE** to submit the changes, or **DELETE** to delete the rule with the parameters, or **CANCEL** to exit without saving.

## UPnP Management

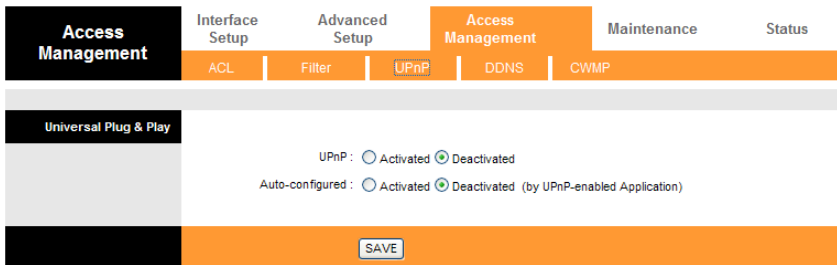
Universal Plug and Play (UPnP) is an open networking standard that uses TCP/IP for simple peer-to-peer network connectivity between devices. An

UPnP device can dynamically join a network, obtain an IP address, convey its capabilities and learn about other devices on the network. A device can leave a network smoothly and automatically when it is no longer in use.

UPnP hardware is identified as an icon in the **Network Connection** folder (in Windows XP). Each UPnP-compatible device that is installed on the W300 network will appear as a separate icon.

Figure 27 shows the UPnP management page. Set the parameters according to requirement and click the **SAVE** button to save the changes.

**FIGURE 27 THE UPnP MANAGEMENT PAGE**



## DDNS Management

Dynamic DNS (DDNS) allows the user to update the current dynamic IP address with one or many dynamic DNS services so that anyone can contact the user through various applications.

The user needs to have registered a dynamic DNS account with [www.dyndns.org](http://www.dyndns.org). It is for people with a dynamic IP from their ISP or DHCP server that would still like to have a DNS name. The dynamic DNS service provider will give the user a password or key.

Figure 28 shows the DDNS management page. Table 24 describes the parameters.

FIGURE 28 THE DDNS MANAGEMENT PAGE

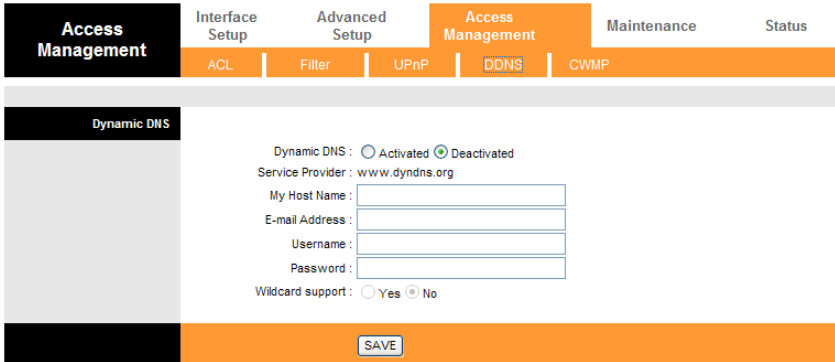


TABLE 24 THE DDNS PARAMETERS

Parameter	Description
Active	Dynamic DNS can be toggled <b>Activated</b> or <b>Deactivated</b> .
Service Provider	The name of the dynamic DNS service provider.
My Host Name	Enter the domain name assigned to the W300 router by the dynamic DNS provider.
E-mail Address	Enter the user’s e-mail address.
Username	Enter the username provided by ISP.
Password	Enter the password.
Wildcard support	Choose whether or not to have DYNDNS Wildcard.

Click the **SAVE** button to save the changes.

## CWMP Management

Figure 29 shows the **CWMP management** configuration page. By default, the CWMP service is deactivated. Users can activate the service and set the parameters according to Table 25.

**FIGURE 29 THE CWMP MANAGEMENT PAGE**

Access Management	Interface Setup	Advanced Setup	Access Management		Maintenance	Status
	ACL	Filter	UPnP	DDNS	CWMP	
<b>CWMP Setup</b>						
	CWMP : <input type="radio"/> Activated <input checked="" type="radio"/> Deactivated					
Login ACS	URL : <input type="text"/>					
	User Name : <input type="text"/>					
	Password : <input type="text"/>					
Connection Request	Path : <input type="text" value="tr069"/>					
	Port : <input type="text" value="7547"/>					
	UserName : <input type="text"/>					
	Password : <input type="text"/>					
Periodic Inform	Periodic Inform : <input checked="" type="radio"/> Activated <input type="radio"/> Deactivated					
	Interval(s) : <input type="text" value="96400"/>					
			<input type="button" value="SAVE"/> <input type="button" value="CANCEL"/>			

**TABLE 25 THE CWMP PARAMETERS**

Parameter	Description
CWMP	CWMP can be toggled <b>Activated</b> and <b>Deactivated</b> .
URL	Enter the URL address of the ACS server
User Name	Enter the user name of W300 to login the ACS server.
Password	Enter the password of W300 to login the ACS server.
Path	Enter the path for the packet exchange between the W300 router and the ACS server. By default, the path is tr069.
Port	Enter the port for the packet exchange between the W300 router and the ACS server. By default, the port is 80.
UserName	Enter the user name for the ACS server to access the W300 router.
Password	Enter the password for the ACS server to access the W300 router.
Periodic inform	To configure whether the W300 router sends the <b>Inform</b> packet periodically.
Interval(s)	Enter the interval to send the Inform packet: 1 ~ 86400 s (24 hours)

Click the **SAVE** button to save the changes or **CANCEL** to discard the changes.



This page is intentionally blank.

# Chapter 7

## Maintenance

The **Maintenance** page helps the user to manage the W300 router.

### Administration Configuration

The **Administration** page, as shown in Figure 30 is used to change the W300 router login password. Click the **SAVE** button to save the new password or **CANCEL** to discard the changes.

FIGURE 30 THE ADMINISTRATION CONFIGURATION PAGE

The screenshot shows the ZTE 中兴 ZXV10 W300 web interface. The top navigation bar includes 'Maintenance' (selected), 'Interface Setup', 'Advanced Setup', 'Access Management', and 'Status'. Below this, a sub-menu for 'Maintenance' contains 'Administration', 'Time Zone', 'Firmware', 'SysRestart', and 'Diagnostics'. The 'Administration' section is active, displaying a form for changing the administrator password. The form includes a 'Username' field with the value 'admin', a 'New Password' field, and a 'Confirm Password' field. At the bottom of the form are 'SAVE' and 'CANCEL' buttons.

## Time Zone Configuration

The **Time Zone** configuration page is used to change the W300 router's date and time, as shown in Figure 31. Click the **SAVE** button to save the new password or **CANCEL** to discard the changes.

FIGURE 31 THE TIME ZONE CONFIGURATION PAGE

Maintenance	Interface Setup	Advanced Setup	Access Management	Maintenance	Status
	Administration	Time Zone	Firmware	SysRestart	Diagnostics

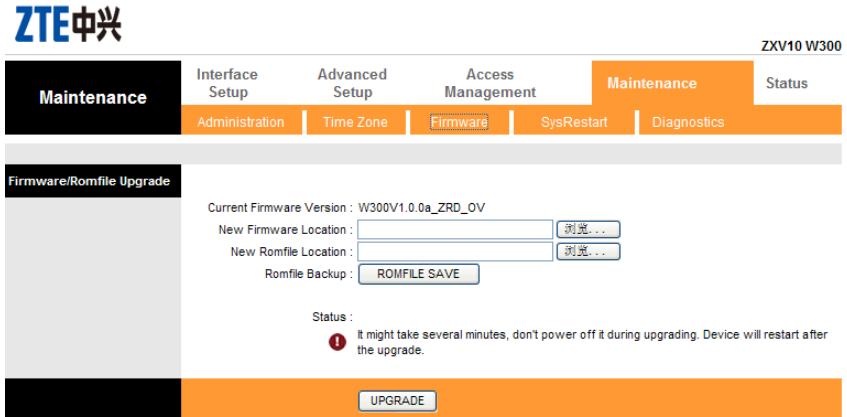
Time Zone	Current Date/Time : 01/01/2000 00:52:18
Time Synchronization	Synchronize time with : <input checked="" type="radio"/> NTP Server automatically <input type="radio"/> PC's Clock <input type="radio"/> Manually
	Time Zone : (GMT) Greenwich Mean Time : Dublin, Edinburgh, Lisbon, London
	Daylight Saving : <input type="radio"/> Enabled <input checked="" type="radio"/> Disabled
	NTP Server Address : 0.0.0.0 (0.0.0.0: Default Value)
<input type="button" value="SAVE"/> <input type="button" value="CANCEL"/>	

## Firmware Configuration

The **Firmware** configuration page shown in Figure 32 is used to view and update the W300 router firmware.

Click the **Browse** button to upload the firmware. And then click the **UPGRADE** button to perform the update.

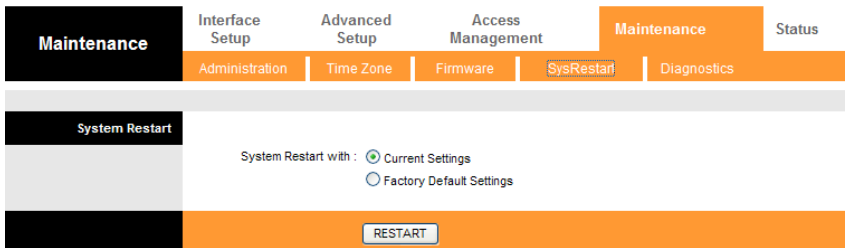
FIGURE 32 THE FIRMWARE CONFIGURATION PAGE



## SysRestart Configuration

The **SysRestart** configuration page is used to determine whether the current setting or the factory default setting to be loaded after the W300 router restarting. Click the **RESTART** button to restart the W300 router.

FIGURE 33 THE SYSTEM RESTART CONFIGURATION PAGE

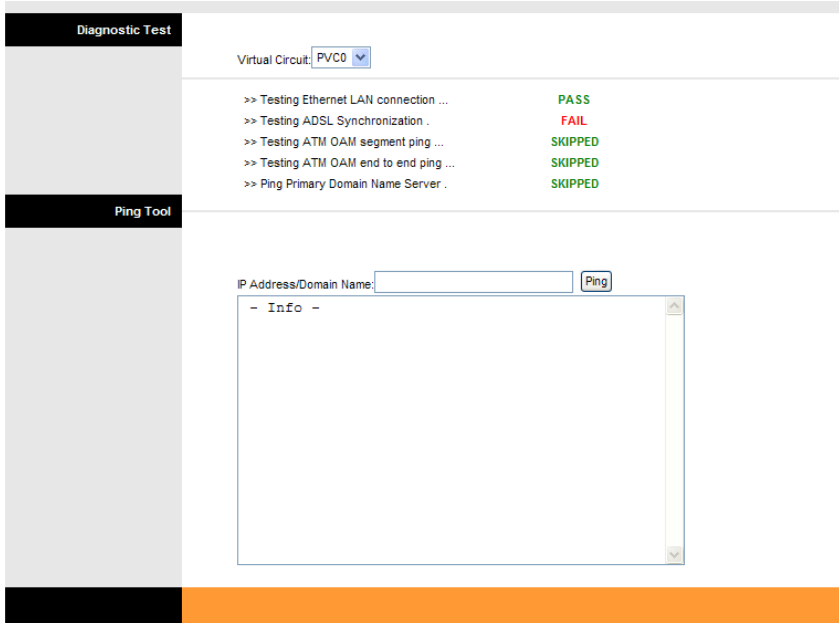


## Diagnostics

The performance of the virtual circuits can be tested through the Diagnostics page, as shown in Figure 34. Select a PVC from the dropdown list and the corresponding testing result will be displayed.

**PASS** means the test is passed; **FAIL** means the test is failed; **SKIPPED** means the test is skipped.

FIGURE 34 THE DIAGNOSTICS PAGE



## Chapter 8

# Status

---

The **Status** page provides the information about the W300 router.

## Device Information

Figure 35 is the **Device Information** page. It presents the Internet related settings of the W300 router.

FIGURE 35 THE DEVICE INFORMATION PAGE



ZXV10 W300

Status	Interface Setup	Advanced Setup	Access Management	Maintenance	Status
	Device Info	System Log	Statistics		
<b>Device Information</b>	Firmware Version : W300V1.0.0a_ZRD_OV MAC Address : d0:15:4a:01:e2:3a				
<b>LAN</b>	IP Address : 192.168.1.1 Subnet Mask : 255.255.255.0 DHCP Server : Enabled				
<b>WAN</b>	Virtual Circuit : <input type="text" value="PVC0"/> Status : Not Connected Connection Type : Bridge IP Address : N/A Subnet Mask : N/A Default Gateway : N/A Primary DNS : N/A Secondary DNS : N/A				
<b>ADSL</b>	ADSL Firmware Version : FwVer:3.12.8.200_TC3086 HwVer:T14.F7_7.0 Line State : Down Modulation : N/A Annex Mode : N/A				
			Downstream	Upstream	
	SNR Margin :	N/A	N/A	db	
	Line Attenuation :	N/A	N/A	db	
	Data Rate :	N/A	N/A	kbps	

## System Log

The **System Log** page displays a log of the W300 router operating, as shown in Figure 36. Click the **CLEAR LOG** button to clear the log or **SAVE LOG** to save the log to a file.

FIGURE 36 THE SYSTEM LOG PAGE

The screenshot shows the 'System Log' page of a ZTE W300 router. The navigation bar includes 'Status', 'Interface Setup', 'Advanced Setup', 'Access Management', 'Maintenance', and 'Status'. The 'System Log' tab is selected, displaying a scrollable log window with the following entries:

```
1/1/2000 0:0:4> MPOA Link Down
1/1/2000 0:0:4> LAN promiscuous mode <1>
1/1/2000 0:0:4> Last errorlog repeat 1 Times
1/1/2000 0:0:4> main: init completed
1/1/2000 0:0:4> adjtime task pause 1 day
1/1/2000 0:9:40> ADSL: L1 Recovery
1/1/2000 0:19:17> ADSL: L1 Recovery
1/1/2000 0:28:54> ADSL: L1 Recovery
1/1/2000 0:38:31> ADSL: L1 Recovery
1/1/2000 0:48:8> ADSL: L1 Recovery
```

At the bottom of the page, there are two buttons: 'CLEAR LOG' and 'SAVE LOG'.

## Statistics

The Statistics page shown in Figure 37 presents the information on how much data the W300 router has processed. Choose **Ethernet**, **ADSL** or **WLAN** option to view the corresponding statistics information. Click the **REFRESH** button to update the data.



FIGURE 37 THE STATISTICS PAGE



ZXV10 W300

Status	Interface Setup	Advanced Setup	Access Management	Maintenance	Status
	Device Info	System Log	Statistics		

**Traffic Statistics**

Interface :  Ethernet  ADSL  WLAN

Transmit Statistics		Receive Statistics	
Transmit Frames	893	Receive Frames	953
Transmit Multicast Frames	140	Receive Multicast Frames	58
Transmit total Bytes	661682	Receive total Bytes	142090
Transmit Collision	0	Receive CRC Errors	0
Transmit Error Frames	0	Receive Under-size Frames	0

**Traffic Statistics**

Interface :  Ethernet  ADSL  WLAN

Transmit Statistics		Receive Statistics	
Transmit total PDUs	0	Receive total PDUs	0
Transmit total Error Counts	0	Receive total Error Counts	0

**Traffic Statistics**

Interface :  Ethernet  ADSL  WLAN

Transmit Statistics		Receive Statistics	
Tx Frames Count	88	Rx Frames Count	42884
Tx Errors Count	0	Rx Errors Count	1670
Tx Drops Count	0	Rx Drops Count	1670

This page is intentionally blank.

## Chapter 9

# Troubleshooting

---

This chapter describes how to troubleshoot problems when installing and using a W300. For any problems not addressed here; contact the service provider for help.

**TABLE 26 TROUBLESHOOTING**

<b>Problem</b>	<b>Troubleshooting</b>
Power indicator is OFF when the device is powered on.	Make sure to use the power adapter included in the package. Make sure that the adapter is connected properly to the device and power outlet.
DSL indicator is OFF when the telephone line is connected.	Make sure to use standard telephone lines (e.g., the companion telephone line). Make sure that the lines are connected properly. Check all the port connections. Wait for 60 seconds for the device to establish an ADSL connection.
When the telephone line is connected, DSL indicator alternates between slow and fast flashing.	It indicates the connection failure between the device and the office-end DSLAM. Please make sure that the lines are connected properly. If a telephone is required to be installed in front of the splitter, make sure to install a voice filter properly.

Problem	Troubleshooting
LAN indicator is OFF when the Ethernet cable is connected.	Make sure that the Ethernet cable is connected properly to the computer and the W300. Make sure that the device and computer are all powered on.
WLAN unable to be connected	Make sure that the WLAN indicator is ON. Make sure that the wireless NIC is set properly. Check the network name, encryption mode, and encryption key to see whether they match the settings of the W300.
PC unable to access the network	<ul style="list-style-type: none"><li data-bbox="393 456 980 579">■ Use the ping command to check if the IP address of the network port of the W300 (192.168.1.1 by default) can be pinged from the computer. If it cannot be pinged successfully, check the Ethernet connection and see if the indicator status is normal.</li><li data-bbox="393 595 980 643">■ It is recommended that the local IP address and DNS server address are set to be obtained automatically.</li><li data-bbox="393 659 980 707">■ It is recommended to close all the running firewall and VPN software.</li><li data-bbox="393 722 980 770">■ Disable the proxy server setting of the web browser (e.g., IE).</li><li data-bbox="393 786 980 861">■ The failure reason may be that the office-end devices of the ADSL service provider are being upgraded or in maintenance.</li></ul>

## Appendix A

# Technical Specifications

---

Items	Parameter Description
ADSL interface	<ul style="list-style-type: none"><li>Compatible standards: ANSI T1.413 Issue 2, ITU G.992.1 (G.dmt), ITU G.992.2 (G.lite), ITU G.992.3 (ADSL2), ITU G.992.5 (ADSL2+), Annex A,, I, J, L,M</li><li>Line impedance: 100 <math>\Omega</math></li><li>Connection line: A pair of ordinary telephone wires</li><li>Connector: RJ-11</li></ul>
LAN interface	<ul style="list-style-type: none"><li>Interface: 10/100 Base-T, IEEE 802.3/802.3u</li><li>Connector: RJ-45</li><li>Automatic recognition of crossover cable and straight-through cable</li></ul>
WAN interface	<ul style="list-style-type: none"><li>Working frequency band: 2.4GHz~2.4835GHz</li><li>Compatible standards: IEEE 802.11b, IEEE 802.11g, IEEE 802.11n</li><li>Rates: 1/2/5.5/11/6/9/12/18/24/36/48/54/150Mbps</li></ul>
Physical size	<ul style="list-style-type: none"><li>Dimensions: 145.0mm ( L ) x 107.6mm ( W ) x 29.3mm ( H )</li></ul>
Weight	<ul style="list-style-type: none"><li>575g(including the package and kits)</li></ul>

Items	Parameter Description
Power adapter	<ul style="list-style-type: none"><li>Input: 100 ~ 240 VAC, 50/60Hz, 250m A(max)</li><li>Output: 12V±5%, 500 mA</li></ul>
Environmental requirement	<ul style="list-style-type: none"><li>Operating temperature: -5 °C ~ 40 °C</li><li>Operating humidity: 30%~90%</li></ul>
Security	<ul style="list-style-type: none"><li>CE</li></ul>

This page is intentionally blank.

## Appendix B

# Computer Configuration

# WLAN

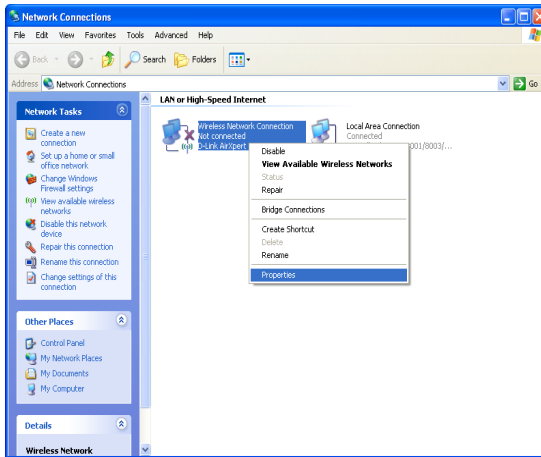
---

To access the W300 in the wireless way from the computer, the user needs to configure WLAN settings of the computer as follows (the following example assumes that the user adopts a laptop computer with a built-in wireless NIC and the operating system is Windows XP):

1. From the Windows taskbar, select **Start > Control Panel**.
2. Double click the **Network Connections** icon. Right-click **Wireless Network Connection** and then select **Properties**. In the **Wireless Network Connection Properties** page, click the **General** tab, and set the wireless NIC to obtain the IP address and DNS server address from the W300 automatically via DHCP. Refer to section **“Configuring TCP/IP”** in Chapter 2 for the detailed procedure.

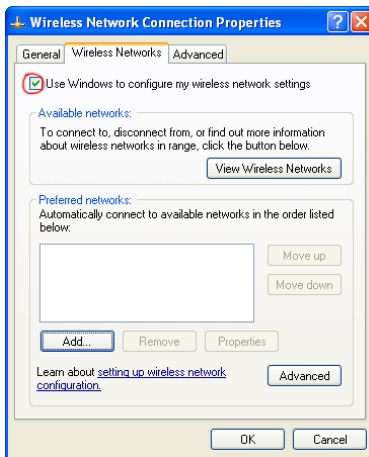


FIGURE 38 NETWORK CONNECTIONS



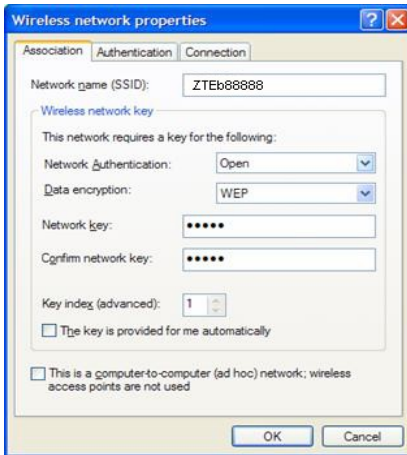
- In the **Wireless Network Connection Properties** page, click the **Wireless Networks** tab, and check **Use Windows to configure my wireless network settings**. Check if the desired WLAN SSID is included in the **Preferred networks** area. If there is no desired SSID, click the **Add** button.

FIGURE 39 WIRELESS NETWORKS



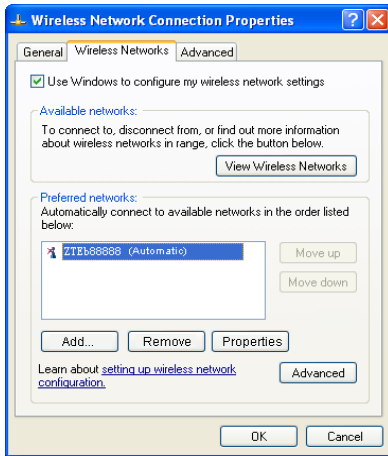
- In the **Network name (SSID)** field, type in an SSID (the same as the one set for the W300; case sensitive). If the W300 enables wireless security (see section **Wireless Security** in **Chapter 6** for security setup), supposing that the user adopts **WEP** with **Both** as **Authentication Type** and **Ee68o** as **Encryption key**, select **Open** for **Network Authentication** and **WEP** for **Data encryption**. Uncheck **The key is provided for me automatically**. In the **Network key** fields, type in **Ee68o** (the same as the encryption key for the W300), and then click **OK**.

FIGURE 40 ASSOCIATION TAB (WIRELESS NETWORK PROPERTIES)



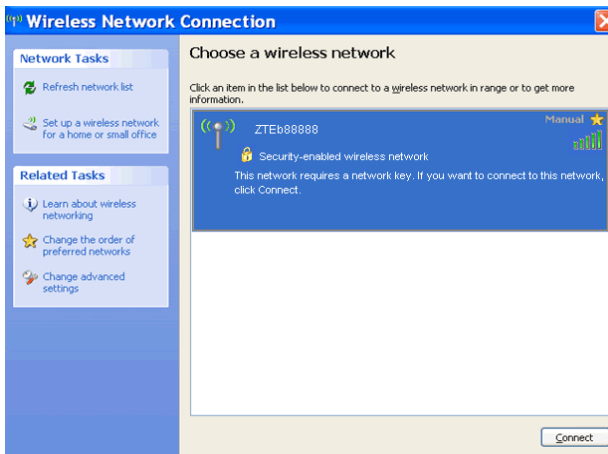
- Click the **View Wireless Networks** button to view the wireless network list.

FIGURE 41 VIEW WIRELESS NETWORKS

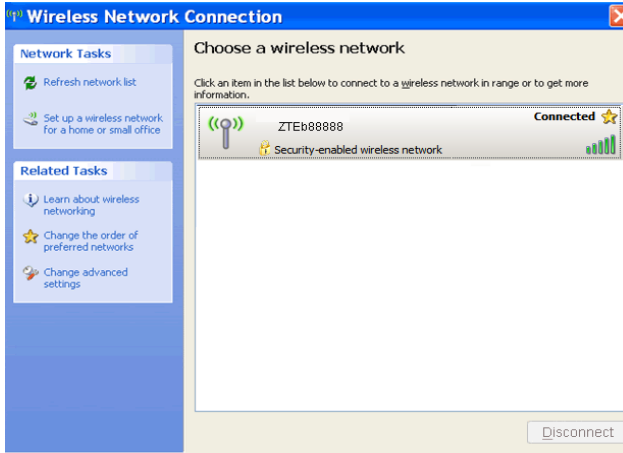


- Check the wireless network list to see if the newly added wireless network connection exists. If not, click **Refresh network list** in the left pane of the page. If the wireless network is found, select it and then click the **Connect** button on the bottom of the page.

FIGURE 42 CHOOSE A WIRELESS NETWORK



7. Now the computer shall be successfully connected to the wireless network.

**FIGURE 43 SUCCESSFUL WIRELESS CONNECTION**



This page is intentionally blank.

## Appendix C

# PPPoE Dial-up Configuration

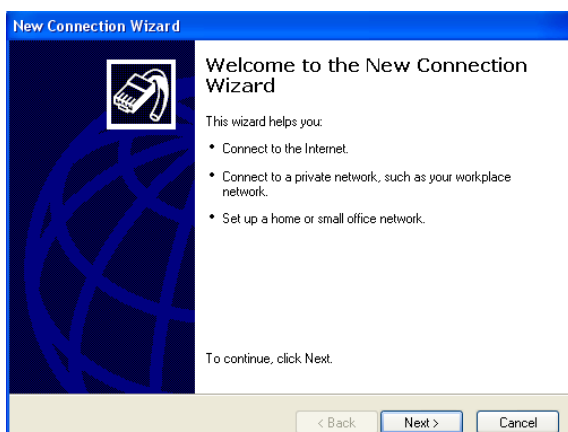
---

This appendix presents the procedures to set up a PPPoE dial-up connection in a Windows XP operation system.

□ To set up a PPPoE dial-up connection:

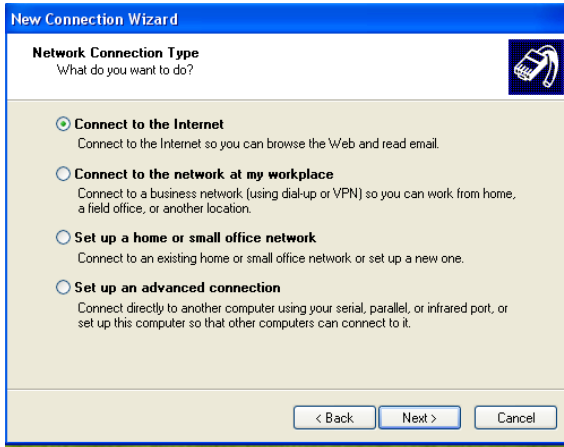
1. Click **Start > All Programs > Accessories > Communications > New Connection Wizard** to open the page as shown in Figure 44.

FIGURE 44 PPPoE DIAL-UP CONFIGURATION 1



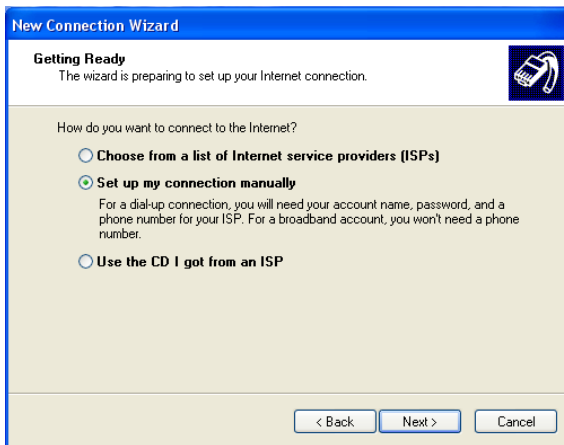
2. Click **Next** and choose the option of **Connect to the Internet**.

**FIGURE 45 PPPoE DIAL-UP CONFIGURATION 2**



3. Click **Next** and choose the option of **Set up my connection manually**.

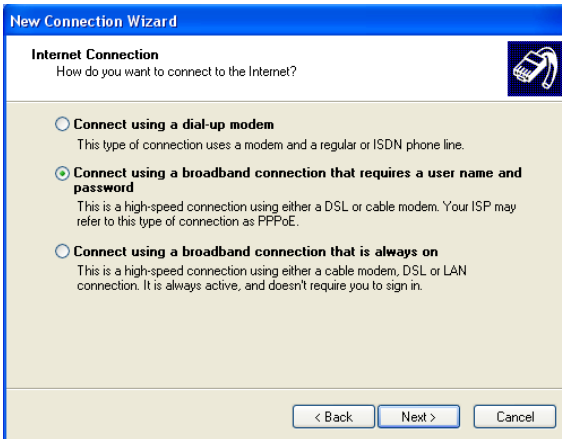
**FIGURE 46 PPPoE DIAL-UP CONFIGURATION 3**





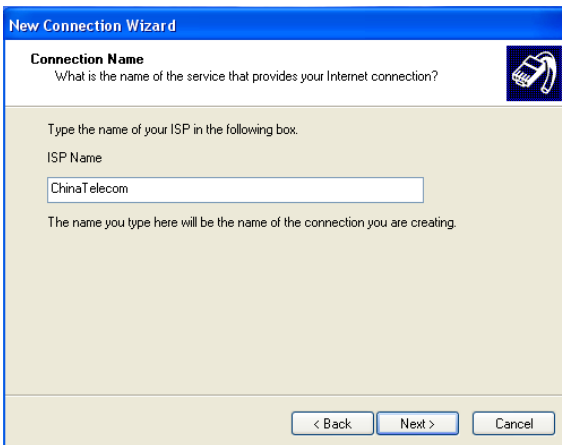
- Click **Next** and choose the option of **Connect using a broadband that requires a user name and password**.

FIGURE 47 PPPOE DIAL-UP CONFIGURATION 4



- Click **Next** and enter the connection name in the ISP name text box (According to the ISP: ChinaTelecom, the following just for example).

FIGURE 48 PPPOE DIAL-UP CONFIGURATION 5



6. Click **Next** and enter the correct user name and password.(According ISP provided:)

FIGURE 49 PPPoE DIAL-UP CONFIGURATION 6

**New Connection Wizard**

**Internet Account Information**  
You will need an account name and password to sign in to your Internet account.

Type an ISP account name and password, then write down this information and store it in a safe place. (If you have forgotten an existing account name or password, contact your ISP.)

User name:

Password:

Confirm password:

Use this account name and password when anyone connects to the Internet from this computer

Make this the default Internet connection

< Back    Next >    Cancel

7. Click **Next** and check the box before **Add a shortcut to this connection to my desktop**.

FIGURE 50 PPPoE DIAL-UP CONFIGURATION 7

**New Connection Wizard**

**Completing the New Connection Wizard**

You have successfully completed the steps needed to create the following connection:

**ChinaTelecom**

- Make this the default connection
- Share with all users of this computer
- Use the same user name & password for everyone

The connection will be saved in the Network Connections folder.

Add a shortcut to this connection to my desktop

To create the connection and close this wizard, click Finish.

< Back    Finish    Cancel

8. Click **Finish**. A PPPoE connection shortcut will be appeared on the desktop. And the connection is established.

# Figures

---

<b>Figure 1 Front Panel.....</b>	<b>2</b>
<b>Figure 2 Rear Panel.....</b>	<b>4</b>
<b>Figure 3 ADSL Uplink Connections.....</b>	<b>8</b>
<b>Figure 4 Ethernet Uplink Connections.....</b>	<b>9</b>
<b>Figure 5 The Login Dialog Box.....</b>	<b>14</b>
<b>Figure 6 Main Page for Configuration.....</b>	<b>15</b>
<b>Figure 7 The Interface Setup Page.....</b>	<b>17</b>
<b>Figure 8 The PVC Summary Table.....</b>	<b>19</b>
<b>Figure 9 Dynamic IP Address Parameters.....</b>	<b>20</b>
<b>Figure 10 Static IP Address Parameters.....</b>	<b>20</b>
<b>Figure 11 PPPoA/PPPoE Parameters.....</b>	<b>22</b>
<b>Figure 12 Bridge Mode Parameters.....</b>	<b>23</b>
<b>Figure 13 The LAN Configuration Page.....</b>	<b>24</b>
<b>Figure 14 The Relay DHCP Web Configuration Page.....</b>	<b>26</b>
<b>Figure 15 The Wireless Configuration Page.....</b>	<b>27</b>
<b>Figure 16 The Firewall Configuration Page.....</b>	<b>30</b>

<b>Figure 17 The Routing Configuration Page.....</b>	<b>31</b>
<b>Figure 18 Adding Route.....</b>	<b>31</b>
<b>Figure 19 The NAT Configuration Page.....</b>	<b>32</b>
<b>Figure 20 The Qos configuration Page.....</b>	<b>33</b>
<b>Figure 21 The VLAN Configuration Page.....</b>	<b>34</b>
<b>Figure 22 Assigning PVID.....</b>	<b>35</b>
<b>Figure 23 Defining VLAN Group.....</b>	<b>36</b>
<b>Figure 24 The ADSL Configuration Page.....</b>	<b>37</b>
<b>Figure 25 The ACL Management Page.....</b>	<b>39</b>
<b>Figure 26 The Filter Management Page.....</b>	<b>40</b>
<b>Figure 27 The UPnP Management Page.....</b>	<b>42</b>
<b>Figure 28 The DDNS Management Page.....</b>	<b>43</b>
<b>Figure 29 The CWMP Management Page.....</b>	<b>44</b>
<b>Figure 30 The Administration Configuration Page.....</b>	<b>47</b>
<b>Figure 31 The Time Zone Configuration Page.....</b>	<b>48</b>
<b>Figure 32 The Firmware Configuration Page.....</b>	<b>49</b>
<b>Figure 33 The System Restart Configuration Page.....</b>	<b>49</b>
<b>Figure 34 The Diagnostics Page.....</b>	<b>50</b>
<b>Figure 35 The Device Information Page.....</b>	<b>52</b>
<b>Figure 36 The System Log Page.....</b>	<b>53</b>

---

<b>Figure 37 The Statistics Page.....</b>	<b>54</b>
<b>Figure 38 Network Connections.....</b>	<b>62</b>
<b>Figure 39 Wireless Networks.....</b>	<b>62</b>
<b>Figure 40 Association Tab (Wireless Network Properties).....</b>	<b>63</b>
<b>Figure 41 View Wireless Networks .....</b>	<b>64</b>
<b>Figure 42 Choose a Wireless Network.....</b>	<b>64</b>
<b>Figure 43 Successful Wireless Connection.....</b>	<b>65</b>
<b>Figure 44 PPPoE Dial-up Configuration 1.....</b>	<b>69</b>
<b>Figure 45 PPPoE Dial-up Configuration 2.....</b>	<b>70</b>
<b>Figure 46 PPPoE Dial-up Configuration 3.....</b>	<b>70</b>
<b>Figure 47 PPPoE Dial-up Configuration 4.....</b>	<b>71</b>
<b>Figure 48 PPPoE Dial-up Configuration 5.....</b>	<b>71</b>
<b>Figure 49 PPPoE Dial-up Configuration 6.....</b>	<b>72</b>
<b>Figure 50 PPPoE Dial-up Configuration 7.....</b>	<b>72</b>

# Tables

---

<b>Table 1</b>	<b>Typographical Conventions.....</b>	<b>i</b>
<b>Table 2</b>	<b>Mouse Operation Conventions.....</b>	<b>ii</b>
<b>Table 3</b>	<b>Safety Signs.....</b>	<b>ii</b>
<b>Table 4</b>	<b>Packing List.....</b>	<b>2</b>
<b>Table 5</b>	<b>Descriptions for the Indicators.....</b>	<b>3</b>
<b>Table 6</b>	<b>Descriptions for the Ports and Buttons.....</b>	<b>4</b>
<b>Table 7</b>	<b>The Descriptions of ATM VC &amp; Qos Parameters.....</b>	<b>18</b>
<b>Table 8</b>	<b>The Descriptions of the Dynamic IP Address Parameters .....</b>	<b>20</b>
<b>Table 9</b>	<b>The Descriptions of the Static IP Address Parameters....</b>	<b>21</b>
<b>Table 10</b>	<b>The Descriptions of the PPPoE/PPPoA Parameters.....</b>	<b>22</b>
<b>Table 11</b>	<b>The Descriptions of the Bridge Mode Parameters.....</b>	<b>23</b>
<b>Table 12</b>	<b>The Descriptions of the Local IP Parameters.....</b>	<b>24</b>
<b>Table 13</b>	<b>The Descriptions of the DHCP Parameters.....</b>	<b>25</b>
<b>Table 14</b>	<b>The Relay DHCP Parameter.....</b>	<b>26</b>
<b>Table 15</b>	<b>The Access Point Parameters.....</b>	<b>28</b>

<b>Table 16 The Multiple SSIDs Parameters.....</b>	<b>28</b>
<b>Table 17 The MAC Filter Parameters.....</b>	<b>29</b>
<b>Table 18 The Static Route Parameters.....</b>	<b>32</b>
<b>Table 19 The PVID Parameters.....</b>	<b>35</b>
<b>Table 20 VLAN Group Setting Parameters.....</b>	<b>36</b>
<b>Table 21 The ADSL Parameters.....</b>	<b>37</b>
<b>Table 22 The ACL Management Parameters.....</b>	<b>39</b>
<b>Table 23 The Filter Management Parameters.....</b>	<b>41</b>
<b>Table 24 The DDNS Parameters.....</b>	<b>43</b>
<b>Table 25 The CWMP Parameters.....</b>	<b>44</b>
<b>Table 26 Troubleshooting.....</b>	<b>56</b>

### ***Environmental Information***

The equipment you purchased has required the extraction and use of natural resources for its production. It may contain substances that are hazardous to people’s health and to the environment. To avoid putting such substances into our environment and to reduce pressure on our natural resources, we ask that you reuse or



recycle your end-of-life equipment by using an accredited electronics take-back system.

The symbols below indicate that this product should be reused or recycled and not simply discarded. Please locate and use an appropriate reuse and recycling site.

If you need more information on collection, reuse and recycling systems, contact your local or regional waste administration. You may also contact your equipment provider for more information on the environmental performances of these products.

