

VSG1432-B101 Series

Quick Start Guide

802.11n Wireless VDSL2 4-port Gateway

Firmware Version 1.10
Edition 1, 9/2010

DEFAULT LOGIN DETAILS

IP Address:	http://192.168.1.1
User Name:	admin
Password:	1234



ZyXEL

Device Panels

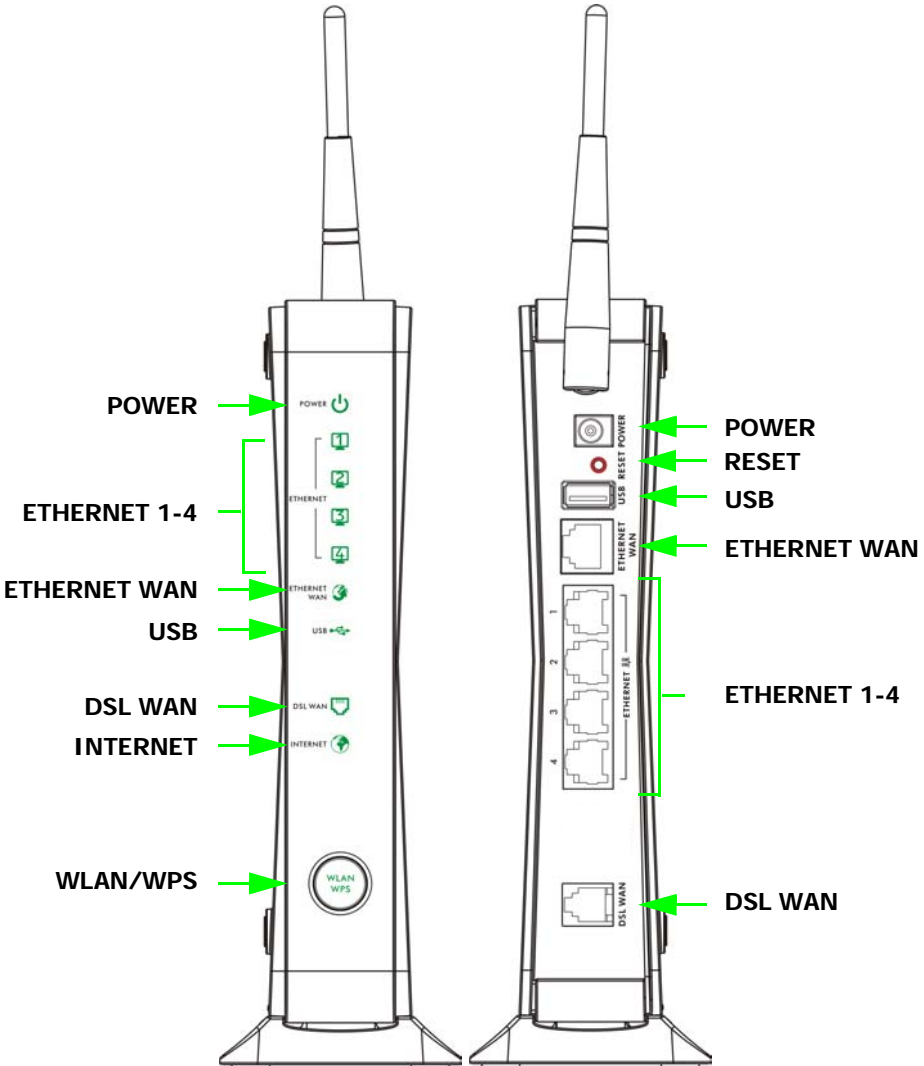

Overview

The VSG1432-B101 is a VDSL2 router and Gigabit Ethernet gateway with a four-port built-in Ethernet switch and IEEE 802.11n wireless. The VSG1432-B101 allows wired and wireless clients to safely access the Internet. The built-in firewall blocks unauthorized access to your network. The USB port allows you to connect USB memory stick or USB hard drive for storing or sharing files through the network. Other helpful features include Quality of Service (QoS) which allows time-sensitive services and applications to flow more smoothly.

Safety Warnings

- Do NOT use this product near water, for example, in a wet basement or near a swimming pool.
- Do NOT expose your device to dampness, dust or corrosive liquids.
- Do NOT store things on the device.
- Do NOT install, use, or service this device during a thunderstorm. There is a remote risk of electric shock from lightning.
- Connect ONLY suitable accessories to the device.
- Do NOT open the device or unit. Opening or removing covers can expose you to dangerous high voltage points or other risks. ONLY qualified service personnel should service or disassemble this device. Please contact your vendor for further information.
- Make sure to connect the cables to the correct ports.
- Place connecting cables carefully so that no one will step on them or stumble over them.

- Always disconnect all cables from this device before servicing or disassembling.
- Use ONLY an appropriate power adaptor or cord for your device.
- Connect the power adaptor or cord to the right supply voltage (for example, 110V AC in North America or 230V AC in Europe).
- Do NOT allow anything to rest on the power adaptor or cord and do NOT place the product where anyone can walk on the power adaptor or cord.
- Do NOT use the device if the power adaptor or cord is damaged as it might cause electrocution.
- If the power adaptor or cord is damaged, remove it from the device and the power source.
- Do NOT attempt to repair the power adaptor or cord. Contact your local vendor to order a new one.
- Do not use the device outside, and make sure all the connections are indoors. There is a remote risk of electric shock from lightning.
- Do NOT obstruct the device ventilation slots, as insufficient airflow may harm your device.
- Use only No. 26 AWG (American Wire Gauge) or larger telecommunication line cord.
- Antenna Warning! This device meets ETSI and FCC certification requirements when using the included antenna(s). Only use the included antenna(s).

Hardware Setup

Place the VSG1432-B101 flat on a desk or table or on the stand for a vertical installation.

Remove the VSG1432-B101's clear plastic covers before using it.

To connect the stand, line up the arrow on the stand with the arrow on the bottom of the device as shown.

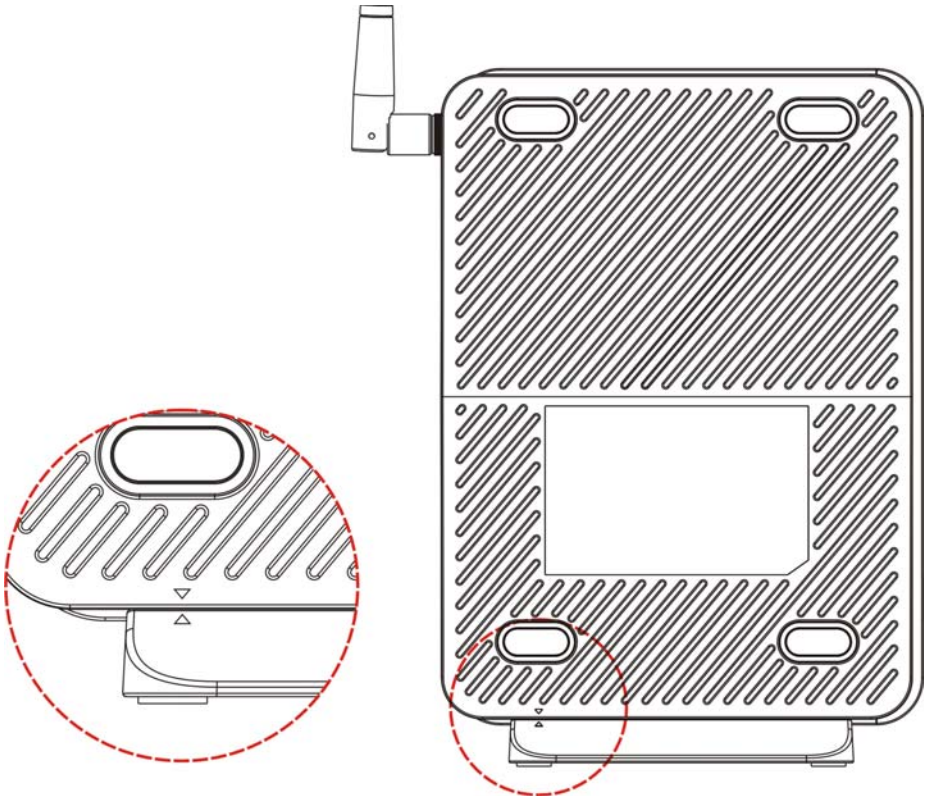

To connect your VSG1432-B101:

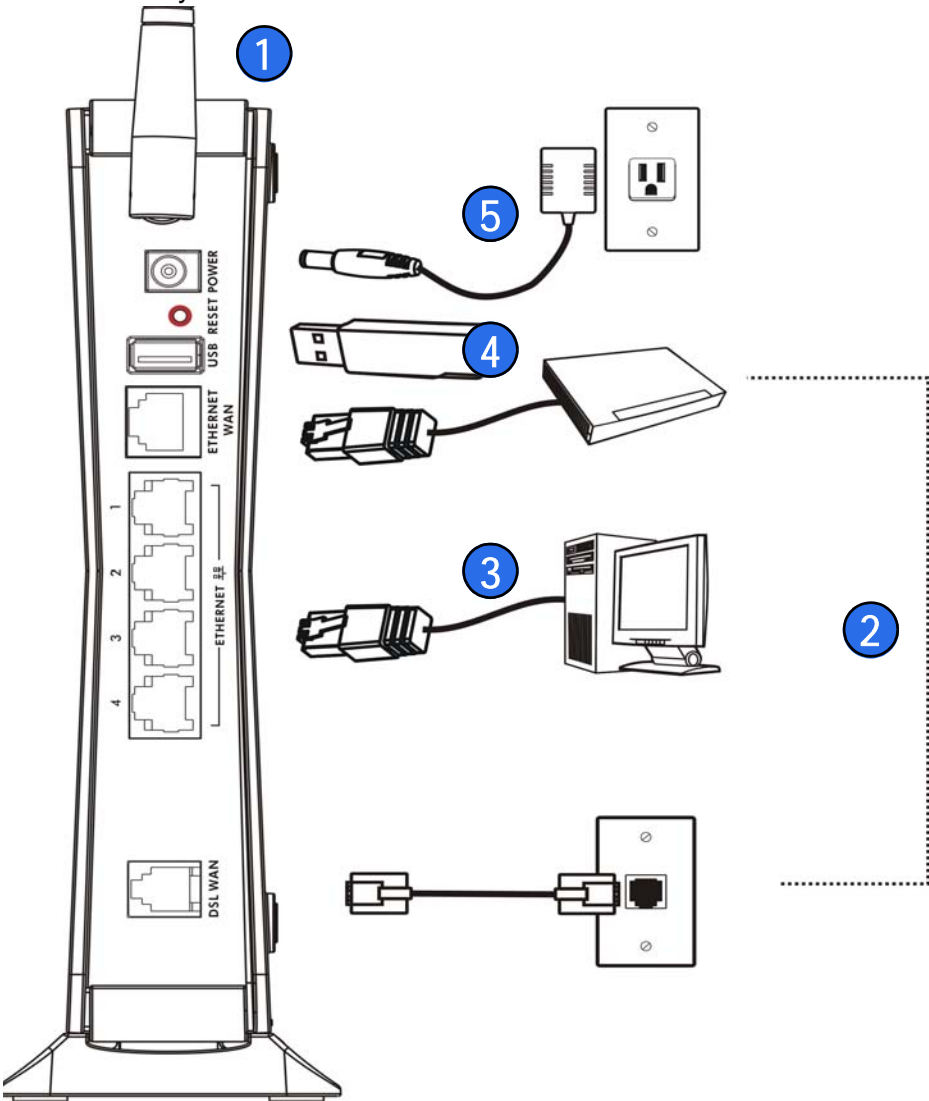

1. Attach the antenna and point it up.

2. Do one of the following for your Internet connection:
 - a. **DSL WAN:** Use a telephone cable to connect your VSG1432-B101's **DSL** port to a telephone jack (or the DSL or modem jack on a splitter if you have one).
 - b. **ETHERNET WAN:** If you already have a broadband router or modem, use an Ethernet cable to connect the **ETHERNET WAN** port to it for Internet access.
3. **LAN:** Use an Ethernet cable to connect a computer to a **LAN** port for initial configuration and/or Internet access.
4. **USB:** Connect a USB (version 2.0 or lower) memory stick or a USB hard drive for file sharing. Use a USB extension cable if the stick is too big to fit.
5. **POWER:** Use the provided power adaptor to connect the **POWER** socket to an appropriate power source. Make sure the power at the outlet is on. After connecting the power adaptor, look at the lights on the front panel.
 - The **POWER** light blinks while your VSG1432-B101 starts up and then stays on once it is ready.
 - Each **LAN** light stays on if the corresponding **LAN** port is properly connected and blinks when there is traffic.
 - The **ETHERNET WAN** light stays on if the **ETHERNET WAN** port is properly connected and blinks when there is traffic.
 - The **USB** light turns on when your VSG1432-B101 detects a connected USB device.
 - The **DSL WAN** light turns on when your VSG1432-B101 has a DSL connection.

- The **WLAN / WPS** light flashes green and orange while WPS is in process. It stays on green when the wireless LAN is ready and blinks when there is traffic.
- The **INTERNET** light turns on when the gateway is able to access the Internet and will blink when your VSG1432-B101 is sending or receiving data.

If the lights do not come on, check your connections and inspect your cables for damage. If the lights are still off, contact technical support.

Set Up a Wireless Network

You can set up a wireless network using the following methods:

Using Wireless Protected Setup (WPS)

Press the **WPS** button on the VSG1432-B101's front panel for more than 5 seconds to turn the WPS function on.

Follow these steps to add a WPS-enabled device to the wireless network using the **WPS/WLAN** button.

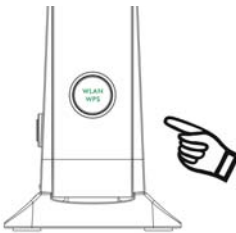

1 Place the devices you want to connect near one another.

2 Press the WPS button on the VSG1432-B101.

The **WPS** light blinks green and orange.



3 Press the WPS button on a compatible device within 2 minutes of pressing the button on the VSG1432-B101.

The **WPS** light on the VSG1432-B101 shines steadily when connected.

Set Up a Wireless Network Manually

The wireless LAN on your VSG1432-B101 is enabled by default. To add a wireless client to the network, use the settings found on the bottom panel of your VSG1432-B101, which will look similar to the following example:

SSID: ZyXEL00561 Security Mode: WPA-PSK Pre-Shared Key: FB373BD356

Configure wireless devices that you want to connect to the wireless network to use the same wireless settings as the VSG1432-B101.

The default wireless settings vary for each VSG1432-B101. Refer to the bottom panel of your device and use the provided information.

Log into the Web Configurator

Your device may already be set up for Internet access. However, you may want or need to log on to the VSG1432-B101 Web Configurator to perform tasks:

- Configure your Internet access settings manually
- Customize the Quality of Service (QoS) and routing features
- Create firewall and web filter rules
- Edit remote management, as well as other features

1. In your browser, if the VSG1432-B101 does not automatically re-direct you to the login screen, go to <http://192.168.1.1>.

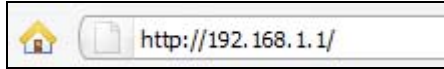

2. Enter the default user name **admin** and password **1234**. Click **Login**.

A screenshot of a login form on a dark blue background. It has two white input fields: "Username:" and "Password:". To the right of the "Password:" field is a white "Login" button.

 If the login screen does not open, make sure you allow web browser pop-up windows, JavaScripts and Java permissions. Your computer should be also set to get an IP address automatically from a DHCP server. See the appendices in your User's Guide for more information.

3. A welcome screen appears with details about your last login. Select **Show this page next time** to see the welcome screen on your next login. Otherwise, clear it. Click **Continue**.

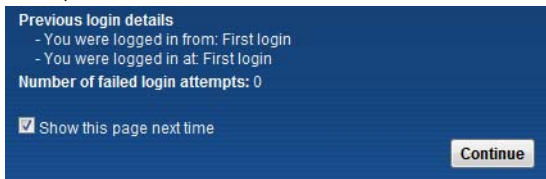
A screenshot of a welcome screen on a dark blue background. It displays "Previous login details" with two lines: "- You were logged in from: First login" and "- You were logged in at: First login". Below that is "Number of failed login attempts: 0". At the bottom left is a checked checkbox labeled "Show this page next time". At the bottom right is a white "Continue" button.

- In the next screen, you can change the login password. This is recommended. Enter your new password in the **New Password** field. Re-type your new password in the second field and then click **Apply**.

If you prefer not to change the password, leave the two fields blank and click **Skip**.



Change password
The password must contain 6 to 15 alphanumeric characters. The password cannot be all numbers or all alphabets.

New Password:

Verify New Password :

You can write down your new password in the following space.

New Password:

5. The **Network Map** page appears. This shows whether the VSG1432-B101 and computers/devices connected to it have Internet access.



6. Click **Status** to display the following screen, where you can view the VSG1432-B101's device, interface, and system information.

Device Information

Host Name:	ZyXEL
Model Number:	VSG1432-B101
Firmware Version:	1.10(TUG.0)e1
WAN Information:	
LAN Information:	
- MAC Address:	02:10:18:01:00:01
- IP Address:	192.168.1.1
- IP Subnet Mask:	255.255.255.0
- DHCP:	Server
WLAN Information:	
- MAC Address:	02:10:18:01:00:02
- Status:	Off
- Name (SSID):	ZyXEL00000
- Channel:	Auto (Current: 6)
- Security Mode:	WPA-PSK
- 802.11 Mode:	802.11b/g/n Mixed
- WPS:	Off

Interface Status

Interface	Status	Rate
LAN1	NoLink	N/A
LAN2	Up	100M / Full
LAN3	NoLink	N/A
LAN4	NoLink	N/A
WLAN	Disabled	N/A
Ethernet WAN	NoLink	N/A
DSL	NoLink	N/A

System Status

System Up Time:	0 days: 0 hours: 9 minutes
Current Date/Time:	01 Jan 1970 00:09:22
System Resource:	
- CPU Usage:	1.00%
- Memory Usage:	55%

7. Click **Quick Start** and configure the VSG1432-B101's time zone Internet access, and wireless settings.

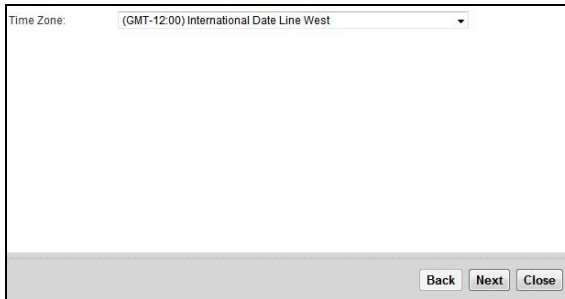

The screenshot shows a configuration window with a label 'Time Zone:' followed by a dropdown menu. The dropdown menu is open, showing the selected option '(GMT-12:00) International Date Line West'. At the bottom of the window, there are three buttons: 'Back', 'Next', and 'Close'.

See your User's Guide for how to use the rest of the Web Configurator screens. You will need to refer to the section on how to setup the **Broadband** connection if the **INTERNET** LED (light) remains off.

Viewing Certifications

- Go to www.zyxel.com.
- Select your product from the drop-down list box on the ZyXEL home page to go to that product's page.
- Select the certification you wish to view from this page or click on the **Specifications** tab to see the certifications list.

FCC Statement

This device complies with part 15 of the FCC Rules. Operation is subject to the following two conditions: (1) This device may not cause harmful interference, and (2) this device must accept any interference received, including interference that may cause undesired operation.

For a Class B digital device or peripheral, the instructions furnished the user shall include the following or similar statement, placed in a prominent location in the text of the manual:















NOTE: This equipment has been tested and found to comply with the limits for a Class B digital device, pursuant to Part 15 of the FCC Rules. These limits are designed to provide reasonable protection against harmful interference in a residential installation. This equipment generates, uses and can radiate radio frequency energy and, if not installed and used in accordance with the instructions, may cause harmful interference to radio communications. However, there is no guarantee that interference will not occur in a particular installation.

If this equipment does cause harmful interference to radio or television reception, which can be determined by turning the equipment off and on, the user is encouraged to try to correct the interference by one or more of the following measures:

- Reorient or relocate the receiving antenna.
- Increase the separation between the equipment and receiver.
- Connect the equipment into an outlet on a circuit different from that to which the receiver is connected.
- Consult the dealer or an experienced radio/TV technician for help.

RF exposure warning

This equipment must be installed and operated in accordance with provided instructions and the antenna(s) used for this transmitter must be installed to provide a separation distance of at least 20 cm from all persons and must not be co-located or operating in conjunction with any other antenna or transmitter. End-users and installers must be provide with antenna installation instructions and transmitter operating conditions for satisfying RF exposure compliance.

ENGLISH	DEUTSCH	ESPAÑOL	FRANÇAIS
<p>Green Product Declaration</p> <p>RoHS Directive 2002/95/EC</p>   <p>WEEE Directive 2002/96/EC (WEEE: Waste Electrical and Electronic Equipment) 2003/108/EC</p> <p>Declaration Signature: <i>Alan Cho</i></p> <p>Name/Title: Alan Cho / Quality Assurance Director Date (yyyy/mm/dd): 2009/3/24</p>	<p>Green Product Declaration</p> <p>RoHS Directive 2002/95/EC</p>   <p>WEEE Directive 2002/96/EC (WEEE: Waste Electrical and Electronic Equipment) 2003/108/EC</p> <p>Unterschrift des Erklärenden: <i>Alan Cho</i></p> <p>Name/Title: Alan Cho / Quality Assurance Director Datum (JJJJ/MM/TT): 2009/3/24</p>	<p>Declaración de Producto Ecológico</p> <p>Directiva RoHS 2002/95/EC</p>   <p>Directiva REEE 2002/96/EC (REEE : Residuos de Equipos Eléctricos y Electrónicos) 2003/108/EC</p> <p>Firma de declaración: <i>Alan Cho</i></p> <p>Nombre/Título: Alan Cho / Quality Assurance Director Fecha (aaaa/mm/dd): 2009/3/24</p>	<p>Déclaration de Produit Green</p> <p>Directive RoHS 2002/95/EC</p>   <p>Directive DEEE 2002/96/EC (DEEE : Déchets des Equipements Electriques et Electroniques) 2003/108/EC</p> <p>Signature de la déclaration : <i>Alan Cho</i></p> <p>Nom/Titre : Alan Cho / Quality Assurance Director Date (aaaa/mm/jj) : 2009/3/24</p>
<p>Dichiarazione Green Product</p> <p>Direttiva RoHS 2002/95/CE</p>   <p>Direttiva RAEE 2002/96/CE (RAEE: Rifiuti di Apparecchiature Elettriche ed Elettroniche) 2003/108/CE</p> <p>Firma dichiarazione: <i>Alan Cho</i></p> <p>Nome/Title: Alan Cho / Quality Assurance Director Data (aaaa/mm/gg): 2009/3/24</p>	<p>Productmilieuverklaring</p> <p>RoHS-richtlijn 2002/95/EC</p>   <p>AEEA-richtlijn 2002/96/EC (AEEA: Afgedankte Elektrische en Elektronische Apparaten) 2003/108/EC</p> <p>Verklaringshandtekening: <i>Alan Cho</i></p> <p>Naam/Title: Alan Cho / Quality Assurance Director Datum (jjjj/mm/dd): 2009/3/24</p>	<p>Miljödeklaration</p> <p>RoHS Direktiv 2002/95/EC</p>   <p>WEEE Direktiv 2002/96/EC (WEEE: hantering av elektriskt och elektroniskt avfall) 2003/108/EC</p> <p>Deklaration undertecknad av: <i>Alan Cho</i></p> <p>Namn/Title: Alan Cho / Quality Assurance Director Datum (åååå/mm/dd): 2009/3/24</p>	<p>SVENSKA</p>
<p>ITALIANO</p>	<p>NEDERLANDS</p>	<p>SVENSKA</p>	